

Multilingual Version

[English](#)

[中文](#)

IR NETWORK CAMERA SERIES

OPERATION GUIDE

Please read instructions thoroughly before operation and retain it for future reference.

IMPORTANT SAFEGUARD



All lead-free products offered by the company comply with the requirements of the European law on the Restriction of Hazardous Substances (RoHS) directive, which means our manufacture processes and products are strictly "lead-free" and without the hazardous substances cited in the directive.



The crossed-out wheeled bin mark symbolizes that within the European Union the product must be collected separately at the product end-of-life. This applies to your product and any peripherals marked with this symbol. Do not dispose of these products as unsorted municipal waste. Contact your local dealer for procedures for recycling this equipment.



This apparatus is manufactured to comply with the radio interference requirements.

Federal Communications Commission Interference Statement

This equipment has been tested and found to comply with the limits for a Class B digital service, pursuant to Part 15 of the FCC rules. These limits are designed to provide reasonable protection against harmful interference in a residential installation.

Any changes or modifications made to this equipment may void the user's authority to operate this equipment. This equipment generates, uses, and can radiate radio frequency energy. If not installed and used in accordance with the instructions, may cause harmful interference to radio communications. However, there is no guarantee that interference will not occur in a particular installation. If this equipment does cause harmful interference to radio or television reception, which can be determined by turning the equipment off and on, the user is encouraged to try to correct the interference by one or more of the following measures:

- Reorient or relocate the receiving antenna.
- Increase the separation between the equipment and receiver.
- Connect the equipment into an outlet on a circuit different from that to which the receiver is connected.
- Consult the dealer or an experienced radio/TV technician for help.
- FCC Caution: Any changes or modifications not expressly approved by the party responsible for compliance could void the user's authority to operate this equipment.
- All external cables connecting to this basic unit must be shielded.
For cables connecting to PCMCIA cards, see the option manual or installation instructions.

This device complies with Part 15 of the FCC Rules. Operation is subject to the following two conditions:

- (1) This device must not cause harmful interference, and
- (2) This device must accept any interference received, including interference that may cause undesired operation.

Trademark Acknowledgements

iPad® & iPhone® are the registered trademarks of Apple Inc.

Android™ is a trademark of Google Inc. Use of this trademark is subject to Google Permissions.

Microsoft®, Windows® & Internet Explorer® are registered trademarks of Microsoft Corporation in the United States and/or other countries.

Disclaimer

We reserve the right to revise or remove any content in this manual at any time. We do not warrant or assume any legal liability or responsibility for the accuracy, completeness, or usefulness of this manual. The content of this manual is subject to change without notice.

This product doesn't have a standby / off mode.

MPEG4 Licensing

THIS PRODUCT IS LICENSED UNDER THE MPEG4 VISUAL PATENT PORTFOLIO LICENSE FOR THE PERSONAL AND NON-COMMERCIAL USE OF A CONSUMER FOR (i) ENCODING VIDEO IN COMPLIANCE WITH THE MPEG4 VISUAL STANDARD ("MPEG-4 VIDEO") AND/OR (ii) DECODING MPEG4 VIDEO THAT WAS ENCODED BY A CONSUMER ENGAGED IN A PERSONAL AND NON-COMMERCIAL ACTIVITY AND/OR WAS OBTAINED FROM A VIDEO PROVIDER LICENSED BY MPEG LA TO PROVIDE MPEG4 VIDEO. NO LICENSE IS GRANTED OR SHALL BE IMPLIED FOR ANY OTHER USE. ADDITIONAL INFORMATION INCLUDING THAT RELATING TO PROMOTIONAL INTERNAL AND COMMERCIAL USES AND LICENSING MAY BE OBTAINED FROM MPEG LA, LLC. SEE [HTTP://WWW.MPEGLA.COM](http://www.mpegla.com).

GPL Licensing



This product contains codes which are developed by Third-Party-Companies and which are subject to the GNU General Public License ("GPL") or the GNU Lesser Public License ("LGPL").

The GPL Code used in this product is released without warranty and is subject to the copyright of the corresponding author.

Further source codes which are subject to the GPL-licenses are available upon request.

We are pleased to provide our modifications to the Linux Kernel, as well as a few new commands, and some tools to get you into the code. The codes are provided on the FTP site, and please download them from the following site or you can refer to your distributor:

http://download.dvrtw.com.tw/GPL/076D_Series/arm-linux-2.6.tar.gz

TABLE OF CONTENTS

1. OVERVIEW.....	1
1.1 Product Features.....	1
1.2 Package Content.....	1
1.3 Product Overview.....	1
1.4 Rear Panel.....	1
1.5 External I/O Port.....	2
1.6 Status Indicator.....	2
2. CAMERA ACCESS WITH INTERNET EXPLORER.....	3
2.1 Camera Login.....	3
2.2 Control Panel Overview.....	3
2.3 Digital PTZ (DPTZ) Operations (Megapixel Models Only).....	5
2.4 Event Record Search & Playback.....	6
3. CAMERA CONFIGURATIONS.....	7
3.1 System configuration menu.....	7
3.2 Network.....	8
3.2.1 Network.....	8
3.2.2 QoS.....	8
3.2.3 DDNS.....	8
3.2.4 SNTP.....	9
3.2.5 FTP.....	9
3.2.6 MAIL.....	9
3.2.7 SMS.....	10
3.2.8 Filter.....	11
3.2.9 UPnP / Bonjour.....	11
3.2.10 RTP.....	12
3.3 Camera.....	13
3.3.1 Camera.....	13
3.3.2 Video.....	13
3.3.3 Color.....	14
3.3.4 Audio.....	14
3.3.5 Advance.....	14
3.4 Record.....	15
3.4.1 Record.....	15
3.4.2 Record Timer.....	15
3.5 Storage.....	15
3.5.1 Memory.....	15
3.6 Trigger.....	15
3.6.1 Trigger.....	16
3.7 General.....	17
3.7.1 General.....	17
3.7.2 Time.....	18
3.7.3 Server Log.....	18
3.7.4 Online.....	19
3.7.5 Account.....	19
3.7.6 Google Maps.....	20
3.7.7 Maintenance.....	20
APPENDIX 1 PRODUCT SPECIFICATIONS.....	22
APPENDIX 2 BIT RATE TABLE FOR REFERENCE.....	23
APPENDIX 3 POE CONNECTION (Megapixel Models Only).....	26
APPENDIX 4 API ID APPLICATION FOR SMS MESSAGING.....	27
APPENDIX 5 Q&A.....	29
APPENDIX 6 RECORDING TIME TABLE.....	30

1. OVERVIEW

1.1 Product Features

- Easy **network setup** with your **iPhone / iPad**
- **ONVIF** standard supported to simplify system integration
- **External alarm I/O device** connection
- Microphone & speaker built-in for **audio transmission**
- **Remote Surveillance**
 - **Fully compatibility** on **iPhone & iPad**, and **Internet Explorer®** on **Windows®** operating system
- (Megapixel Models Only) **POE (Power-over-Ethernet)** support to eliminate the use of power cables and reduce installation costs
- (2 Megapixel Model Only) **2 Megapixel** SONY sensor with **HDTV 1080p** quality, allowing users to notice minor details more easily
- (1.3 Megapixel Model Only) **1.3 Megapixel** SONY sensor with **HDTV 720p** quality, allowing users to notice minor details more easily

1.2 Package Content

<input type="checkbox"/> Network camera	<input type="checkbox"/> Camera Bracket	<input type="checkbox"/> 3-pin Terminal
<input type="checkbox"/> Quick Setup with iPhone / iPad	<input type="checkbox"/> Adapter (Optional)	

1.3 Product Overview

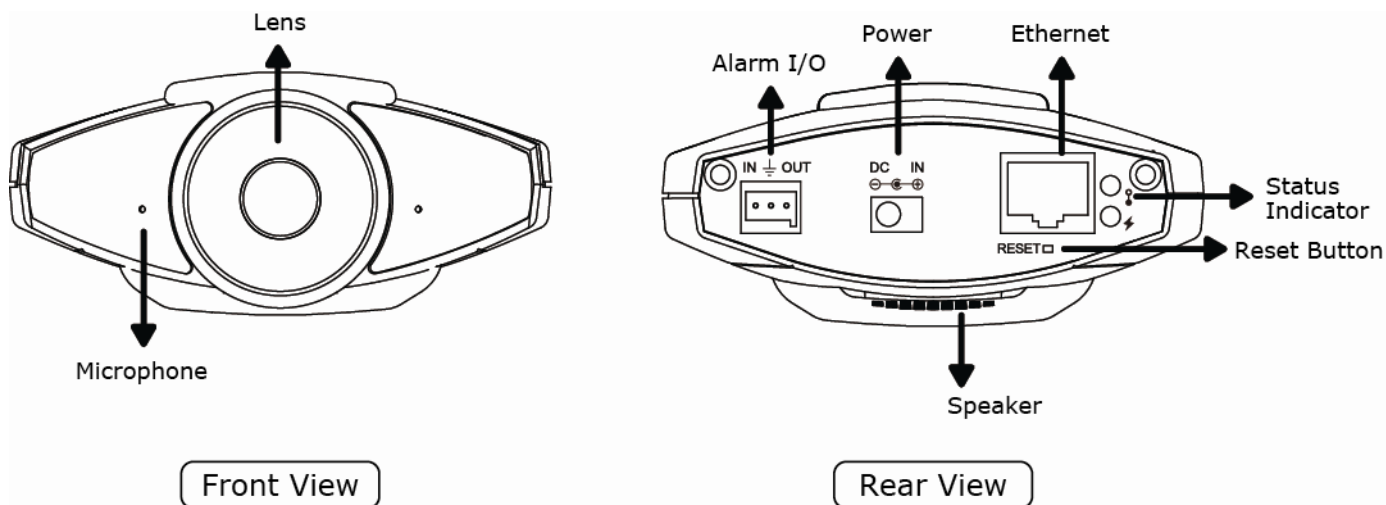

1.4 Rear Panel

Ethernet:	Connect a RJ45 network cable.
Power:	Connect the regulated power supply.
RESET:	With the power connected, press to reset all parameters, including the IP address to factory default settings. The camera will reboot after default reset. Please do not disconnect your camera during the reset process.
Alarm I/O:	A 3-pin I/O terminal is supplied with the camera for external alarm device connection. For details, please refer to "1.5 External I/O Port" at page 2.
Status Indicator	🔦 is the indicator for LAN connection, and ⚡ is the indicator for Internet connection. For details, please refer to "1.6 Status Indicator" at page 2.

1.5 External I/O Port

This camera supports external I/O device connection, and a 3-pin I/O terminal is supplied with this camera for easy connection.

Below shows which input on the I/O terminal you should use for wiring when you want to connect an external device to this camera.

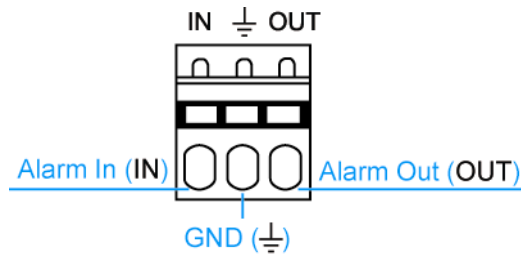

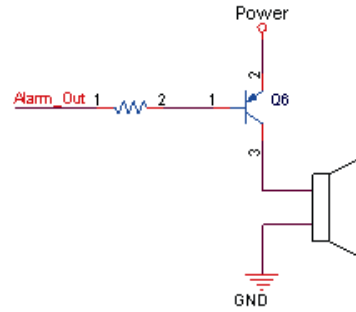

3-pin I/O Terminal



Alarm Out Connection

1.6 Status Indicator

ICON	 LAN connection status	 Internet connection status
System Status		
During powering on	Always on	Always on
Reset default	Blinking (on 250 ms, off 250 ms) ●○○●○○●○○●○○	Always off
Upgrade	Blinking (on 250 ms, off 250 ms) ●○○●○○●○○●○○	Blinking (on 250 ms, off 250 ms) ●○○●○○●○○●○○
Connection Status		
LAN connected	Always on	--
LAN disconnected	Blinking (on 100 ms, off 500 ms) ●○○●○○●○○	--
Internet connected	--	Always on
Internet disconnected	--	Blinking (on 100 ms, off 500 ms) ●○○●○○●○○
3G Connection Error on iPhone / iPad / Android Mobile Device		
3G Connection Setting Uncompleted	--	Blinking (on 5 sec, off 0.5 sec, on 0.5 sec, off 0.5 sec, on 5 sec) ●●●●●○○●●●●●

* LED blinking frequency - ● LED on / ○ LED off

2. CAMERA ACCESS WITH INTERNET EXPLORER

This network camera can be accessed via Microsoft® Internet Explorer® and iPhone / iPad / Android mobile devices with our self-developed program “EagleEyes” installed depending on different using situations.

Note: For details about accessing network cameras via iPhone / iPad / Android mobile devices, please refer to <http://www.eagleeyescctv.com>.

Before using the camera, make sure you have configured the network settings, and the network connection is fine.

For network configurations, please refer to:

- **“Quick Setup With iPhone / iPad”** supplied with your camera if you’re using iPhone / iPad, and your network environment is wireless.
- **“ADVANCED NETWORK SETUP”** downloadable from www.surveillance-download.com/user/m317a.swf if your network environment is not wireless.

2.1 Camera Login

Step1: Open your web browser, and key in <http://ipaddress:portnum> in the URL address box.

For example, for the IP address 60.121.46.236 and port No. 888, please key in “<http://60.121.46.236:888>” into the URL address box, and press “Enter”.

Step2: In the login page, key in the user name and password, and enter the security code from the image below if any. Then, click “LOGIN”.

Step3: The wizard is then started.

- To skip the wizard and directly access the camera live view, click “Close”.
- To directly access the camera live view without starting the wizard for the login next time, check “Do not start wizard at login”.









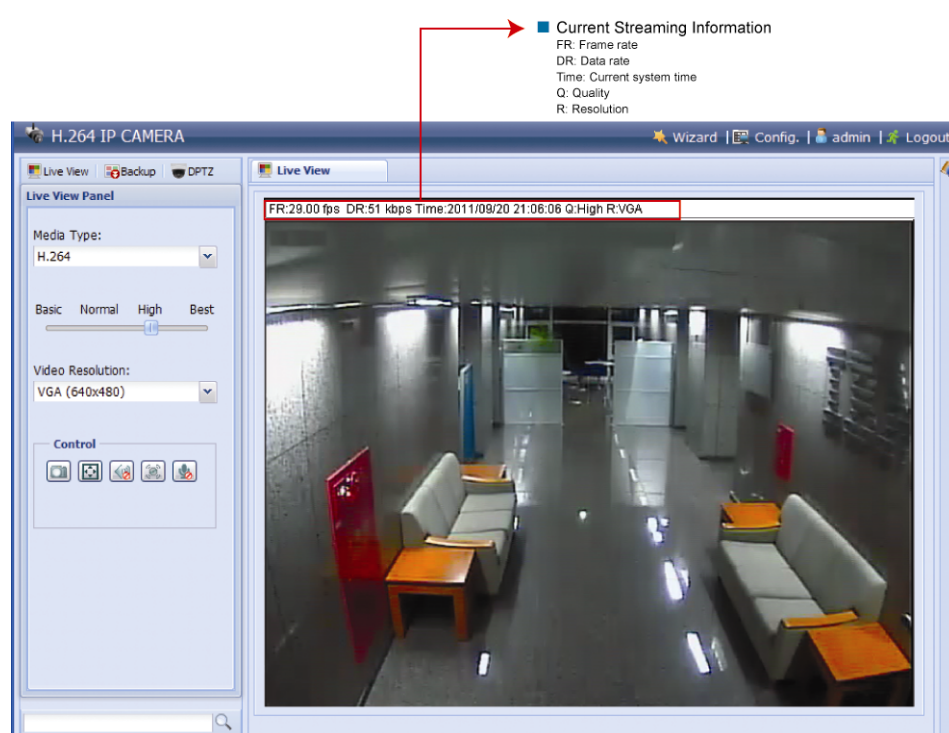



Note: If you’re prompted to install “VLC player”, “Software” or “H264 Streaming Viewer”, please agree to proceed the installation. Or, you might not be able to see the live view properly.

Step5: When the login is successful, the live view is shown.

2.2 Control Panel Overview

Note: The buttons available depend on the model number used and the user level used to log in.



Function	Icon	User Level	Description															
Live		Supervisor / Power User / Normal User / Guest	Switch to the live view page.															
Backup		Supervisor / Power User	Enter the event record list for video playback. For details, please refer to "2.4 Event Record Search & Playback" at page 6.															
DPTZ*		Supervisor / Power User / Normal User	Switch to the DPTZ configuration page. For details, please refer to "2.3 Digital PTZ (DPTZ) Operations (Megapixel Models Only)" at page 5.															
Config.		Supervisor	Switch to the system configuration page, and the functions available for "Supervisor" and "Power User" are different. For details, please refer to "3.1 System configuration menu" at page 7.															
Media Type	--	Supervisor / Power User / Normal User / Guest	Select the image player from the drop-down list: <ul style="list-style-type: none"> ■ H.264 / MPEG-4 / Motion JPEG ■ QuickTime <p>QuickTime is Apple Inc.'s multimedia software. You need to have QuickTime installed in your operating system before selecting "QuickTime". When it is selected, you will be promoted to enter the user name and password to access the camera.</p> <ul style="list-style-type: none"> ■ VLC 															
Quality	--	Supervisor / Power User / Normal User	Click & drag the slider to select the video quality: Basic / Normal / High / Best.															
Video Resolution	--	Supervisor / Power User / Normal User	Select the image resolution from the drop list: <table border="1" style="width: 100%; border-collapse: collapse;"> <thead> <tr> <th style="text-align: left;">2 Megapixel Model</th> <th style="text-align: left;">1.3 Megapixel Model</th> <th style="text-align: left;">D1 Model</th> </tr> </thead> <tbody> <tr> <td>■ HD1080P (1920 x 1080)</td> <td>■ SXGA (1280 x 1024)</td> <td>■ D1 (720 x 480)</td> </tr> <tr> <td>■ HD720P (1280 x 720)</td> <td>■ HD720P (1280 x 720)</td> <td>■ CIF (352 x 240)</td> </tr> <tr> <td>■ VGA (640 x 480)</td> <td>■ VGA (640 x 480)</td> <td>■ CIF (352 x 240)</td> </tr> <tr> <td>■ QVGA (320 x 240)</td> <td>■ QVGA (320 x 240)</td> <td></td> </tr> </tbody> </table>	2 Megapixel Model	1.3 Megapixel Model	D1 Model	■ HD1080P (1920 x 1080)	■ SXGA (1280 x 1024)	■ D1 (720 x 480)	■ HD720P (1280 x 720)	■ HD720P (1280 x 720)	■ CIF (352 x 240)	■ VGA (640 x 480)	■ VGA (640 x 480)	■ CIF (352 x 240)	■ QVGA (320 x 240)	■ QVGA (320 x 240)	
2 Megapixel Model	1.3 Megapixel Model	D1 Model																
■ HD1080P (1920 x 1080)	■ SXGA (1280 x 1024)	■ D1 (720 x 480)																
■ HD720P (1280 x 720)	■ HD720P (1280 x 720)	■ CIF (352 x 240)																
■ VGA (640 x 480)	■ VGA (640 x 480)	■ CIF (352 x 240)																
■ QVGA (320 x 240)	■ QVGA (320 x 240)																	
Live View Size:		Supervisor / Power User / Normal User																
Full Screen			Click to display the image in full screen. To exit the full screen mode, press "Esc" on your keyboard. <i>This icon appears only when the selected resolution is HD1080P, SXGA, HD720P, VGA or D1.</i>															
Double size			The QVGA resolution is resized to fit into the current live view size. <i>This icon appears only when the selected resolution is QVGA or CIF.</i>															
Normal Size			The current live view size is the same as the selected resolution. <i>This icon appear only when the selected resolution is SXGA or HD720P or HD1080P.</i>															
Fit to screen			The selected resolution is resized to fit into the current live view size. <i>This icon appear only when the selected resolution is SXGA or HD720P or HD1080P.</i>															
No Scale			Click and hold the movable square on the left bottom corner of the live view to move <i>This icon appear only when the selected resolution is SXGA or HD720P or HD1080P.</i>															
Snapshot		Supervisor / Power User / Normal User	Click to take a snapshot of the current view on a new window. Right click on the picture and re-save it to the location you want.															
Audio On / Off		Supervisor / Power User / Normal User	Click to switch the audio-in on / off.															
Alarm Out		Supervisor / Power User / Normal User	Click to force your alarm-out device to work. For example, when your alarm device is a buzzer, click this button and your buzzer will start to sound even if there's no alarm event.															
Microphone		Supervisor	Click to switch the audio-out on / off.															





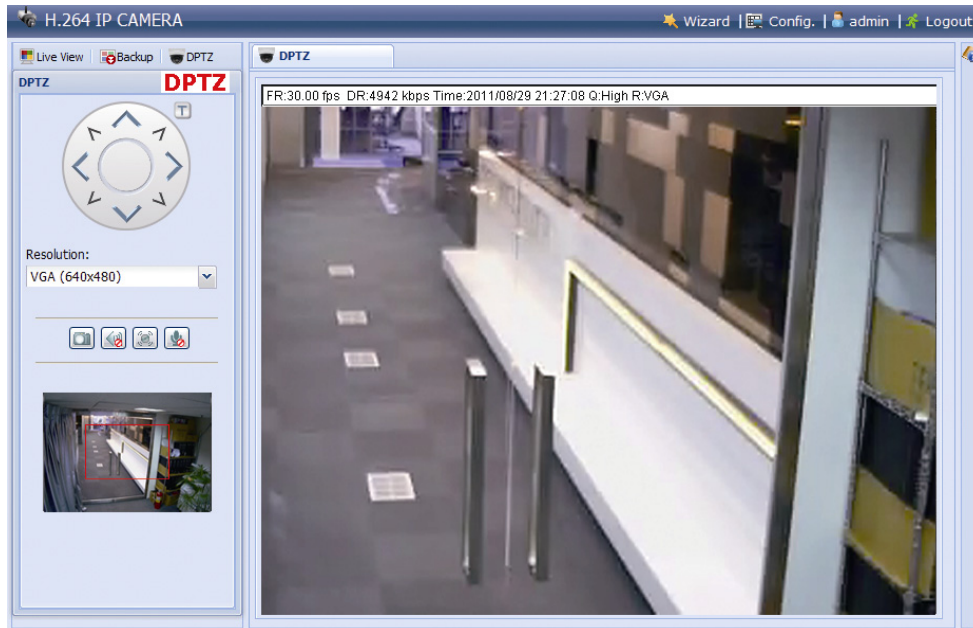

2.3 Digital PTZ (DPTZ) Operations (Megapixel Models Only)

This camera has PTZ capability, i.e. digital PTZ (hereafter called “DPTZ”), for wide area monitoring.

STEP1: Click “DPTZ” to show the DPTZ control panel.



STEP2: Select the functions when needed:







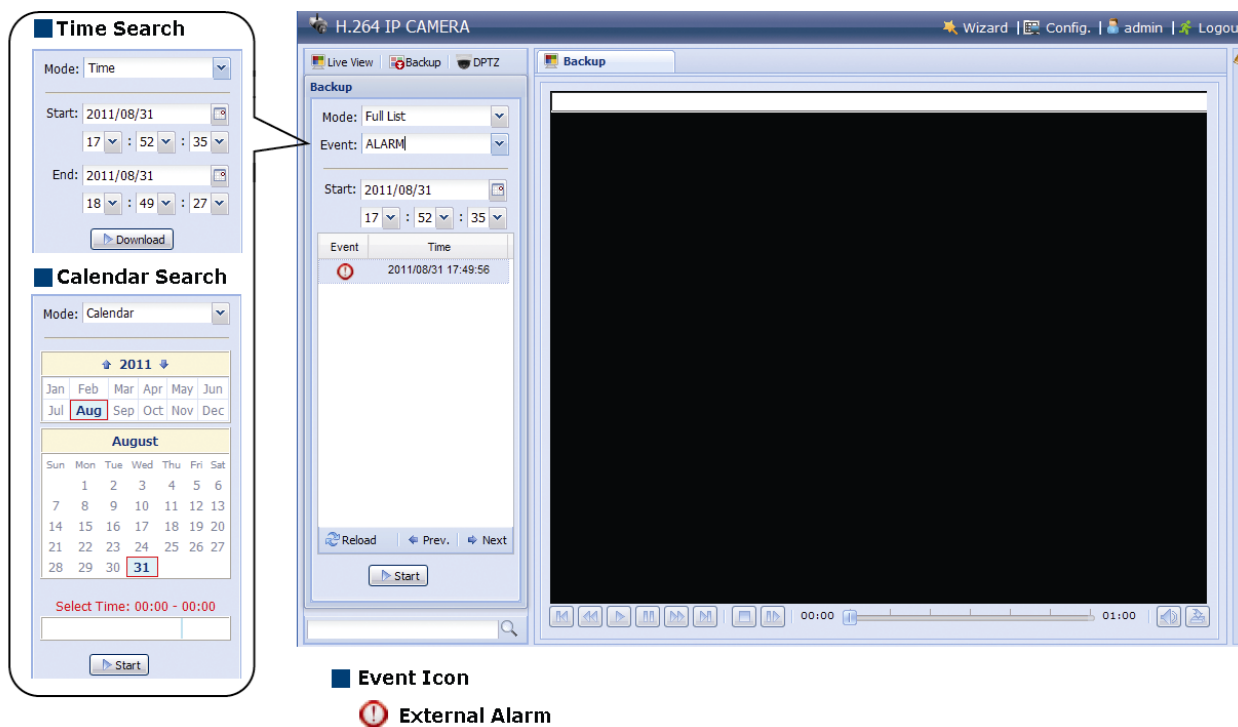

FUNCTION	ICON	DESCRIPTION
Resolution	--	Select the video resolution for the DPTZ function. Only “VGA” and “QVGA” are available.
Take snapshots		Click to take a snapshot of the current view on a new window. Right click on the picture and re-save it to the location you want.
Audio On / Off	 / 	Click to switch the audio-in on / off.
Alarm Out		Click to force your alarm-out device to work. For example, when your alarm device is a buzzer, click this button and your buzzer will start to sound even if there's no alarm event.
Microphone	 / 	Click to switch the audio-out on / off. <i>Available only when you're a "Supervisor".</i>

2.4 Event Record Search & Playback

This camera can only save up to three alarm recordings.

Note: To save more recorded data, it's recommended to use this camera with the compatible NVR.



	Previous / Next Hour	Click to jump to the next / previous time interval in an hour, for example, 11:00 ~ 12:00 or 14:00 ~ 15:00, and start playing the earliest event video clip recorded during this whole hour.
	Fast Forward	Increase the speed for fast forward. Click to get 2X, 4X, 8X & 16X speed forward eventually.
	Fast Rewind	Increase the speed for fast rewind. Click to get 2X, 4X, 8X & 16X speed rewind eventually.
	Play	Click to play the current video clip.
	Pause	Click to pause the video playback.
	Stop	Click to stop the video playback.
	Step	In the pause mode, click to get one frame forward.
	Audio	Click to mute the playback if necessary, and click again to restore.
	Download	Click to download the current video clip to the specified path in your PC. <i>The downloaded video can only be opened by our own video player. Please go to "General" → "Maintenance" to download the video player, or get the player from the CD supplied with the sales package.</i>

3. CAMERA CONFIGURATIONS

Users can further configure this network camera by accessing via Internet Explorer.

3.1 System configuration menu

Click “Config.” to enter the configuration page.

The functions are categorized into six menus: Network, Camera, Record Timer, Storage, Trigger and General.

- For details about “Network”, please refer to “3.2 Network” at page 8.
- For details about “Camera”, please refer to “3.3 Camera” at page 12.
- For details about “Record”, please refer to “3.4 Record” at page 15.
- For details about “Storage”, please refer to “3.5 Storage” at page 15.
- For details about “Trigger”, please refer to “3.6 Trigger” at page 15.
- For details about “General”, please refer to “3.7 General” at page 17.

Main Menu	Sub-Menu	Reference
Network	Network	Configure network settings.
	QoS	Limit the data flow for live streaming.
	DDNS	Enter DDNS information when the network type is PPPOE or DHCP.
	SNTP	Synchronize your camera time with the networked computer systems.
	FTP	Enter the FTP information for event notifications when “FTP” is chosen in “Trigger” → “Trigger”.
	Mail	Enter Email information for event notifications when “Email” is chosen in “Trigger” → “Trigger”.
	SMS	Enter text messaging information for SMS notifications when “SMS” is chosen in “Trigger” → “Trigger”.
	Filter	Choose to permit or block the IP address(es) which can access this camera.
	UPnP	<i>*Suitable for Windows-based operating system.</i> Allow this camera to be detected among devices within the same network area for easy and quick usage.
	Bonjour	<i>*Suitable for Apple Mac-based operating system.</i> Allow this camera to be detected among devices within the same network area for easy and quick usage.
RTP	Set the parameters for video data transmission when you’re using multimedia other than web browsers and Video Viewer for remote access.	
Camera	Camera	1. Rename the camera. 2. Change the place where the camera name is shown on the screen.
	Video	Adjust video-related settings in different video format.
	Color	Adjust the color performance.
	Audio	Adjust the audio volume of the microphone and speaker.
	Advance	Adjust the camera parameters if necessary.
Record	Record	Configure the record function.
	Record Timer	Schedule external alarm recording.
Storage	Memory	Check the current storage capacity and clear all recorded data when needed.

Main Menu	Sub-Menu	Reference
Trigger	Trigger	<ol style="list-style-type: none"> 1. Enable / disable motion and alarm detection. 2. Set the motion detection area. 3. Configure how the camera reacts for any event.
General	General	<ol style="list-style-type: none"> 1. Select the language of the web browser. 2. Check the MAC address of the camera. 3. Lock camera access after the specified time.
	Time	Set daylight saving time and the current time.
	Server Log	Check the system event logs.
	Online	Check the current online user(s).
	Account	<ol style="list-style-type: none"> 1. Create a new user account with different access privilege. 2. Modify or delete an existing user account.
	Google Maps	Allow you to know where the network camera is.
	Maintenance	<ol style="list-style-type: none"> 1. Check the current firmware version and upgrade your camera. 2. Copy system configurations. 3. Reboot the camera. 4. Download the video player to play the recorded data.

3.2 Network

3.2.1 Network

You can set the network configuration of the network camera depending on your network type.

For details, please refer to “Advanced Network Setup” from www.surveillance-download.com/user/m317a.swf.

The screenshot shows the 'Network Configuration' web interface. It features several radio buttons for 'IP Type': 'Static IP' (selected), 'PPPoE', and 'DHCP'. Below these are input fields for 'Server IP' (192.168.1.10), 'Gateway' (192.168.1.1), 'Net Mask' (255.255.255.0), 'Port' (80), 'DNS1' (168.95.1.1), and 'DNS2' (139.175.55.244). A 'MAC Address' field shows '00:0E:53:20:E7:3E'. At the bottom, there are 'Save' and 'Reload' buttons.

3.2.2 QoS

QoS, Quality of Service, is the ability to control the data flow for real-time streaming. This function is important if your network bandwidth is insufficient and you have other devices to share the network bandwidth.

Check “QoS Enable”, and set the max. upload rate from 256 to 10240 kbps.

The screenshot shows the 'QoS Configuration' web interface. It has radio buttons for 'QoS': 'Enable' (selected) and 'Disable'. There is a dropdown menu for 'Interface' set to 'Ethernet' and a text input for 'Max. Upload Rate' set to '4096' kbps. 'Save' and 'Reload' buttons are at the bottom.

3.2.3 DDNS

Select “On” when the selected network type in “Network” is “PPPOE” or “DHCP”.

For details, please refer to “Advanced Network Setup” from www.surveillance-download.com/user/m317a.swf.

The screenshot shows the 'DDNS Configuration' web interface. It has radio buttons for 'DDNS': 'Enable' (selected) and 'Disable'. There are input fields for 'System Name' (eagleeyes), 'Hostname' (MAC000E5320E73E), and 'E-Mail'. A domain suffix '.ddns.eagleeyes.tw' is shown next to the hostname. 'Save' and 'Reload' buttons are at the bottom.

3.2.4 SNTP

SNTP (Simple Network Time Protocol) is used to synchronize your camera time with the networked computer systems.

Function	Description
GMT	Once users choose the time zone, the network camera will adjust the local area time of the system automatically.
NTP Server	Simply use the default SNTP server (For example, tock.stdtime.gov.tw) or change to another server with which users are familiar.
Sync. Period	Select "Daily" to synchronize the camera time with the network time every day or "None" to turn off this function.
Sync	Click and the network camera will synchronize the time with the network time.

3.2.5 FTP

Enter the detailed FTP information and click "Save" to confirm. The information you set here will be applied when "FTP" is selected in "Trigger" → "Trigger".

3.2.6 MAIL

Enter the detailed e-mail information and click "Save" to confirm. The information you set here will be applied when "Email" is selected in "Trigger" → "Trigger".

Function	Description
SMTP Server	Enter the SMTP server address provided from your e-mail system supplier.
Port	Enter the port number provided from your e-mail system supplier. If this column is left blank, the e-mail server will use port 25 to send e-mails.
Mail From	Enter the name of the sender.
SSL Encryption	Select "Yes" if your e-mail server is using SSL encryption to protect your e-mail content from unauthorized access.
Verify Password	Some mail servers are required to verify the password. Please enter the "user name" and "password".
E-Mail Address List	Add the e-mail address(s) of the assigned recipient(s).
Test	When all information is entered, click "Test Mail" to try if the receipt.

3.2.7 SMS

Note: Before using this function, you need to apply an API ID from the mobile messaging company, Clickatell, and you will be charged starting from the 11th message. For details, please refer to 'APPENDIX 4 API ID APPLICATION FOR SMS MESSAGING' at page 27.

Enter the detailed information needed for text messaging, and click "Save" to confirm. The information you set here will be applied when "SMS" is selected in "General" → "Trigger".

The screenshot shows the 'SMS Configuration' window. It contains the following fields and controls:

- System:** A dropdown menu with 'clickatell' selected.
- Username:** A text input field containing 'tech'.
- Password:** A text input field with masked characters '*****'.
- API ID:** A text input field containing '3281378'.
- Recipient:** A text input field containing '+886912665475' with a small flag icon to the left.
- Transfer Interval:** A dropdown menu with '15' selected, followed by the text 'Minute(s)' and a 'Reset Counter' button.
- Message:** A text area containing '[192.168.1.10] unauthorized access!' and a checked checkbox labeled 'Include Hostname or IP'.
- Buttons:** 'Save', 'Test', and 'Reload' buttons are located at the bottom of the form.

Function	Description
System	The text messaging service provider is Clickatell.
User name / Password	Enter the account user name and password you created in Clickatell.
API ID	Enter the API ID you applied from Clickatell.
Recipient	Click "Add" to enter the phone number, including the country code, to receive the text message. Five sets of phone numbers are allowed.
Transfer Interval	Set the interval time in minutes between two-message sending. The options are 0, 15, 30 & 60.
Reset Counter	Click to restart the text messaging, and the SMS will be sent after the specified time interval since you click this button.
Message	Enter the text content (up to 70 characters) you want to send with the text message.
Test	To know whether your SMS setting is correct, click this button to immediately send a SMS to your phone. Note: This testing is not free and you will be charged for SMS sending base on your local rate.

3.2.8 Filter

Choose to permit or block the IP address(es) which can access this camera, and click “Save” to confirm.

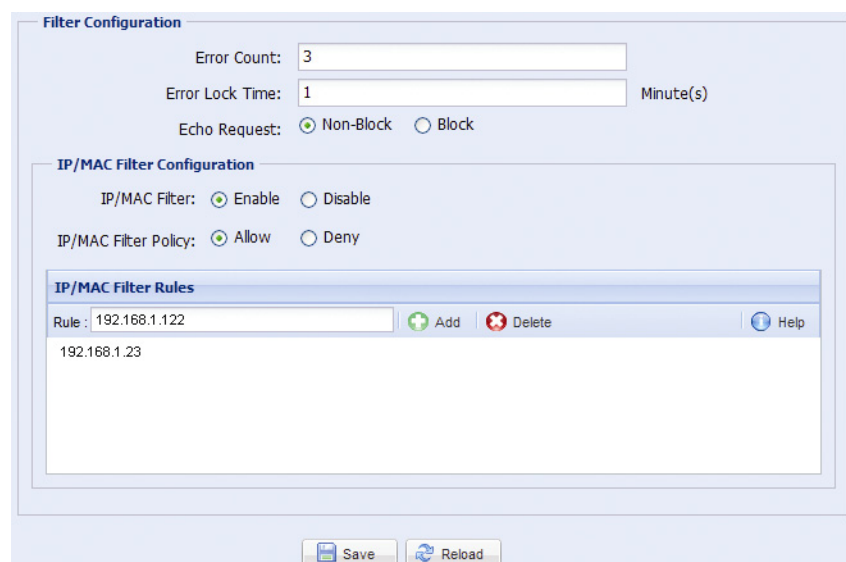

Function	Description
Filter Configuration	
Error Count	Set the maximum count for login failure. When the maximum count is reached, the IP address trying to access the network camera will be locked.
Error Lock Time	Set the lock time in minutes when the maximum count of error login for an IP address is reached.
Echo Request	Select “Non-Block” to allow other users to use the ping command to detect the IP address of your network camera, or “Block” to deny the ping command request.
IP/MAC Filter Configuration	
IP/MAC Filter	Choose to enable or disable the filter function.
IP/MAC Filter Policy	If “Enable” is selected, choose whether you want to permit (Allow) or block (Deny) the IP address list below.
IP/MAC Filter Rules	
Rule	<ul style="list-style-type: none"> To add an item to the IP address list, key in the IP address in “Rule”, and click “Add”. To remove an existing item in the IP address list, click the item you want to remove, and click “Delete”.

3.2.9 UPnP / Bonjour

“UPnP” stands for “Universal Plug and Play”, which allows devices to connect seamlessly in the home and corporate environments and simplify installation of computer components, and is only suitable for Microsoft Windows-based operating system.

“Bonjour” functions the same as “UPnP”, but it’s only suitable for Apple Mac-based operating system.

➤ UPnP

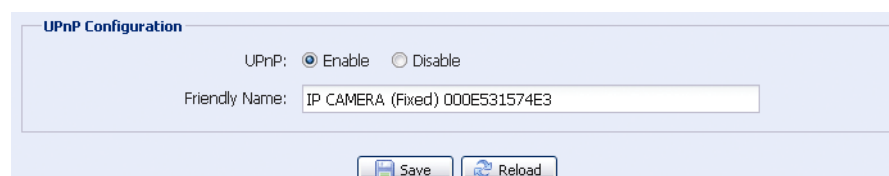

➤ Bonjour

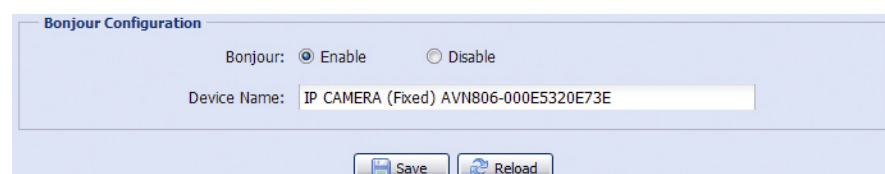

Check “Enable” to allow the network camera to be detected among devices within the same network area, and set the identification name of the camera in “Friendly name”.

When this function is activated, the other PC within the same domain as this camera will be able to search this camera in:

- “Network Neighbor” with the identification name set in “Friendly name” for Windows-based PC, or
- “” (finder) or “Bookmark” with the identification name set in “Device Name” for Mac-based PC.

Double-click it to quickly open the web browser for camera access.

Port Mapping (Available only in UPnP)

This function can eliminate the need to additionally access the router for port forwarding.

For details, please refer to “Advanced Network Setup” from www.surveillance-download.com/user/m317a.swf.

Note: Before using this function, make sure your router supports UPnP, and this function is enabled. If not, please access your router additionally for port forwarding.

When “Port Mapping” is set to “Enable”, the system will automatically assign an IP address or port number for you if no IP address or port number is entered.

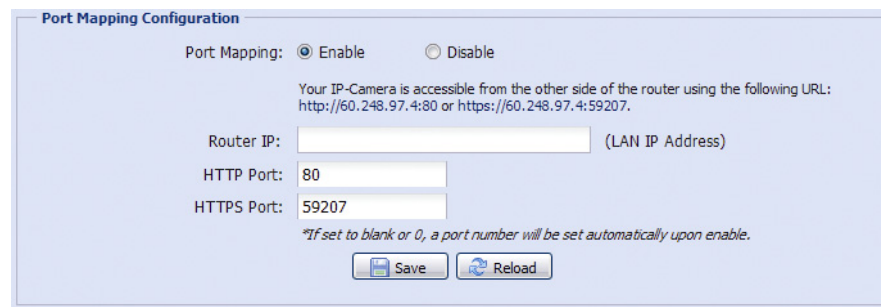

The screenshot shows the 'Port Mapping Configuration' window. It has a title bar and a light blue background. At the top, there are two radio buttons: 'Enable' (selected) and 'Disable'. Below this, a text label reads: 'Your IP-Camera is accessible from the other side of the router using the following URL: http://60.248.97.4:80 or https://60.248.97.4:59207.' There are three input fields: 'Router IP:' (empty), 'HTTP Port:' (containing '80'), and 'HTTPS Port:' (containing '59207'). A small note below the ports says: '*If set to blank or 0, a port number will be set automatically upon enable.' At the bottom, there are two buttons: 'Save' and 'Reload'.

Note: When the configurations are saved successfully, you’ll see a message indicating the IP address and port number assigned to this network camera.

3.2.10 RTP

The Real-time Transport Protocol (RTP) is an Internet protocol standard to manage the real-time transmission of multimedia, such as VLC player.

The media player you want to use for remote access must support RTP transmission for this function to work normally.

Note: When you’re about to end the remote access, please press the stop button on your media player first, and then close the program. This is to ensure the server receives the stop command, and also help to protect the server from redundant data transmission.



The screenshot shows the 'RTP' configuration window. It has a title bar and a light blue background. The 'Port Range' section has two input fields: 'Start Port:' (50000) and 'End Port:' (60000). The 'Multicast' section has three sub-sections: 'H264', 'MPEG4', and 'JPEG'. Each sub-section contains a table with columns 'Resolution', 'Address', and 'Port'. The 'Audio' section has two input fields: 'Audio Address:' (239.101.104.101) and 'Audio Port:' (9000). At the bottom, there is an input field for 'Time to Live (TTL):' (15) and two buttons: 'Save' and 'Reload'.

Resolution	Address	Port
SXGA / HD720P	239.101.101.102	9000
VGA	239.101.101.103	9000
QVGA	239.101.101.104	9000
QQVGA	239.101.101.105	9000

Resolution	Address	Port
SXGA / HD720P	239.101.102.102	9000
VGA	239.101.102.103	9000
QVGA	239.101.102.104	9000
QQVGA	239.101.102.105	9000

Resolution	Address	Port
SXGA / HD720P	239.101.103.102	9000
VGA	239.101.103.103	9000
QVGA	239.101.103.104	9000
QQVGA	239.101.103.105	9000

Function	Description
<ul style="list-style-type: none"> Port Range The port range used by RTP is limited, and preserving 100 ports between the start port and end port is necessary. 	
Start Port	The range of the start port is 1024 ~ 65434.
End Port	The range of the end port is 1124 ~ 65534.
<ul style="list-style-type: none"> Multicast 	
Address and port for H264 / MPEG4 / JPEG transmission	Set a specific address and port for multicast of each stream format (H264/ MPEG4/ JPEG). The range of the address is limited between 224.0.0.1 ~ 239.255.255.255. The port for multicast must be an even number.
Address and port for audio transmission	Set a specific address and port for multicast of audio. The range of the address is limited between 224.0.0.1 ~ 239.255.255.255. The port for multicast must be an even number.
Time to Live (TTL)	The range of Time to Live of the package is between 1 ~ 255. As soon as Time to Live of the package is 0, it will be dropped.

3.3 Camera

3.3.1 Camera

Rename the camera, and change the place where the camera name is shown on the screen, UP-LEFT / UP-RIGHT / DOWN-LEFT / DOWN-RIGHT.

3.3.2 Video

Adjust video-related settings in different video format.

- “Quality” is related to image clearness.
- “FPS” is related to the fluency of the video. The more the FPS, the more fluent the video.
- “Max Bit Rate” is the maximum limitation of data transmission in the selected image format and resolution.

Take the 2 megapixel model as an example below. For the 1.3 megapixel model and D1 model, please refer to its actual display.

Note: QQVGA is for mobile surveillance only.

Configuration			
Power Line Frequency:	50	Hz	
H264			
Resolution	Quality	FPS	Max Bit Rate
HD1080P	HIGH	30	8000
HD720P	HIGH	30	8000
VGA	HIGH	30	3000
QVGA	HIGH	30	3000
QQVGA	HIGH	30	3000
MPEG4			
Resolution	Quality	FPS	Max Bit Rate
HD1080P	HIGH	15	8000
HD720P	HIGH	30	8000
VGA	HIGH	30	3000
QVGA	HIGH	30	3000
QQVGA	HIGH	30	3000
JPEG			
Resolution	Quality	FPS	
HD1080P	HIGH	30	
HD720P	HIGH	30	
VGA	HIGH	30	
QVGA	HIGH	30	
QQVGA	HIGH	30	

3.3.3 Color

Adjust the color performance from Brightness, Contrast, Hue and Saturation. Click and drag the slider to preview the color change on the right side of this page and adjust the image color.

To restore the default values, click “Back to Default”.

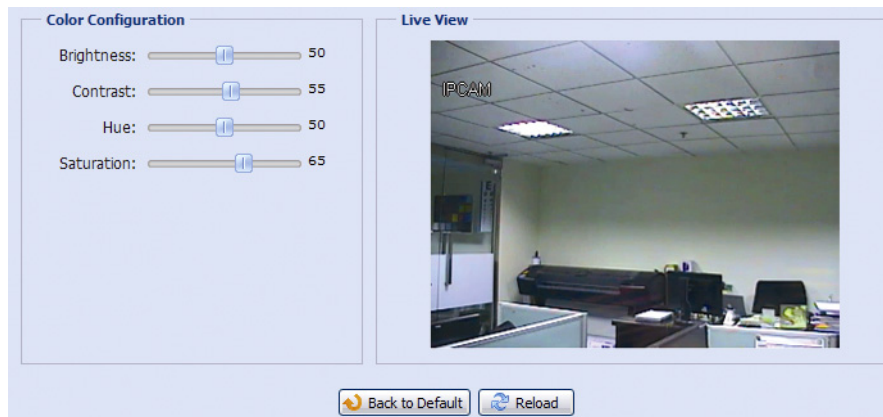

3.3.4 Audio

Drag the slider to adjust the volume of the microphone and speaker.

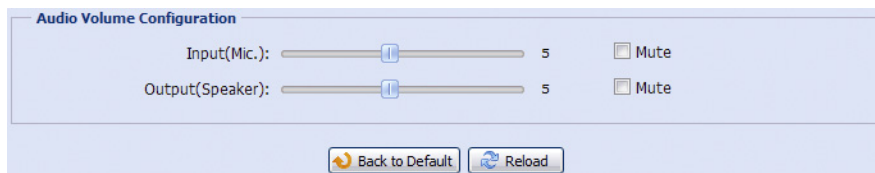

3.3.5 Advance

Adjust the camera parameters if necessary.

Megapixel Models

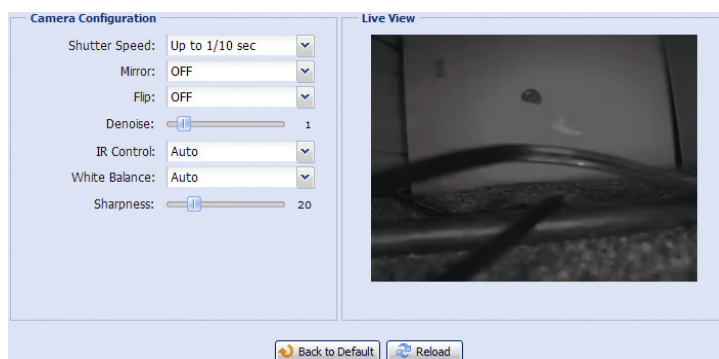

D1 Model

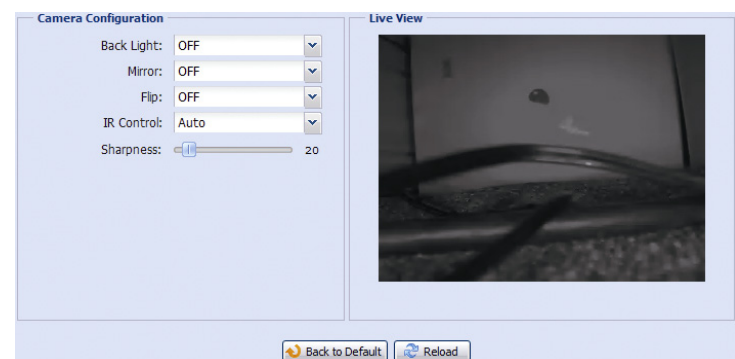

Item	Description
Shutter Speed*	Set the shutter speed based on your need. The options are: Up to 1/10 sec, Up to 1/30, Up to 1/15, Up to 1/6, Up to 1 and Up to 2.
Back Light**	It is the function to adjust the image to compensate for an area that is overpowered by brightness because of excessive light. The image will be properly exposed for clearness. Select to activate (ON) or disable (OFF) this function. Note: This function is available only in the day mode.
Mirror	Select “ON” to rotate the images horizontally based on your installation situation when necessary.
Flip	Select “ON” to rotate the image 180° when necessary.
De-noise*	Click and drag the slider to adjust the level from 0 ~ 10 to decrease the noise shown in the dark environment.
IR Control	Select “Auto” to automatically enable IR LEDs at night or in the dark environment, “On” to always enable IR LEDs, or “OFF” to disable this function.
White Balance*	Process the current image to retain color balance over a color temperature range. The options are: Auto, Incandescent Light, Cool Light, sun Light, Cloudy & Sun Shade.
Sharpness	Sharpness enhances the clarity of image detail by adjusting the aperture and sharpening the edges in the pictures. Hold and drag the slider to adjust the level of sharpness from 0 ~ 100. The higher the value, the sharper the image.

* Megapixel Models Only

**D1 Model Only

3.4 Record

3.4.1 Record

In “Record Configuration”, you can:

- Enable or disable the alarm record function. When “Enable” is set to “No”, the alarm record function is disabled even if you enable it in other configuration pages.
- Select if the data should be overwritten when the memory storage is full.
- Enable or disable the audio record function.
- Select the video resolution for event recording.

Note: The higher resolution you choose, the more accuracy and higher image quality the recording will be, but the faster the memory storage is consumed and become full.

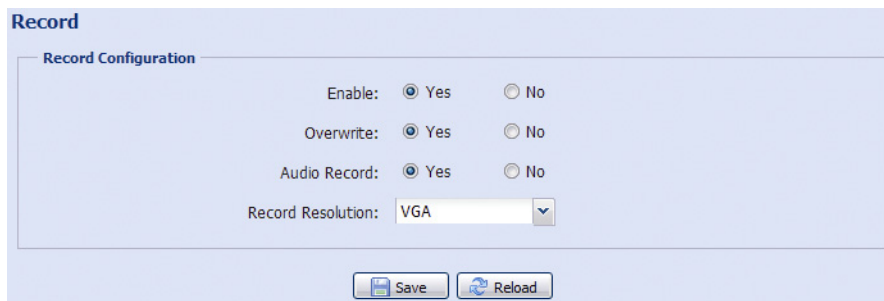

3.4.2 Record Timer

To schedule alarm recording, enable it, and select the day and time for recording.

Note: The timer must be enabled for the record function to work properly.

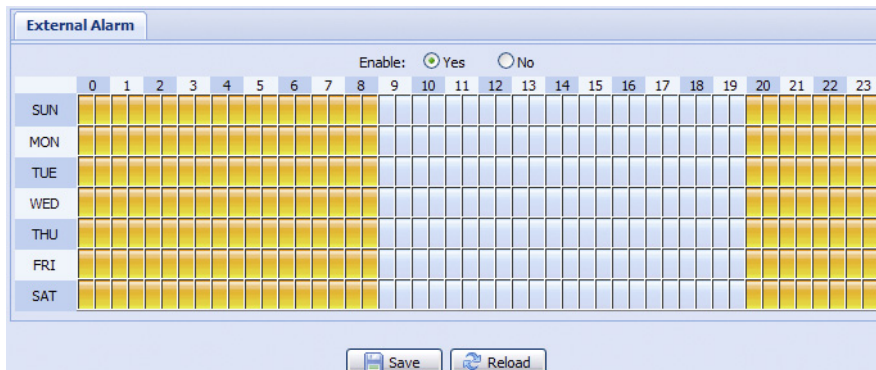

3.5 Storage

3.5.1 Memory

In “Memory”, you can check the remaining capacity for recording, or clear all recorded data saved if needed.

Note: The recorded data will be removed also when you reset or reboot this camera.

Note: To save more recorded data, it's recommended to use this camera with the compatible NVR.

Note: To know the total recording time per recording resolution, please refer to “APPENDIX 6 RECORDING TIME TABLE” at page 30.

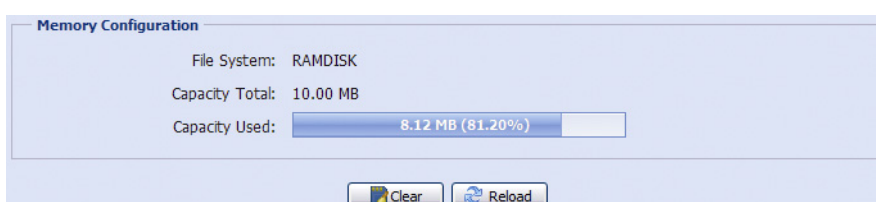

The total capacity for recording may vary depending on different models. Please check the actual display of your model.

3.6 Trigger

3.6.1 Trigger

You can configure how this camera reacts when there's an alarm or motion event.

◆ Detect

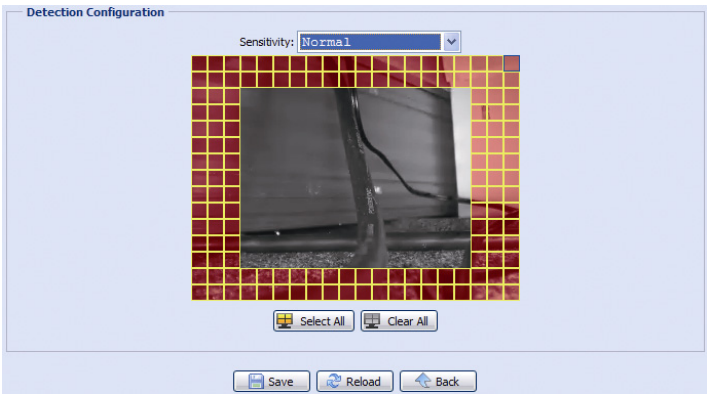
Item	Description
External Alarm	Enable or disable detection from external alarm-in device, and click the title "External Alarm" (in blue) to set "N.O." or "N.C." depending on the configuration of your alarm-in device.
Motion	<p>Enable or disable motion detection.</p> <p><i>Motion detection is not supported when the stream format is Motion JPEG.</i></p> <p>When "Enable" is selected, click "Detection" to enter the motion detection area setting page as follows:</p>  <p>Sensitivity: Set the detection sensitivity from the drop-down list: High, Normal or Low.</p> <p>Area Setting: Set the motion detection area by selecting the area grids with your mouse. Pink grids represent the area that is not being detected while the transparent grids are the area under detection. You can set multiple areas under detection. Click "Clear All" to set the whole area undetected. Click "Select All" to set the whole area under detection.</p>
Duration	Set the duration time for trigger recording (5 / 10 / 20 / 40 seconds).

◆ Action

Here defines how the camera delivers alerts to you for any event.

Item	Description
E-Mail	Select the event type you want to receive E-mail notifications when it occurs. Then, click the title "E-Mail" (in blue) to configure the media type (H264 / JPEG / MPEG4), file format (AVC / AVI), and record time (1 ~ 5 seconds) for the event video clip. The camera will send the captured video clip to the E-mail address(s) you assigned in "Network" → "Mail" once the selected event type occurs.
FTP	Select the event type you want to receive FTP notifications when it occurs. Then, click the title "FTP" (in blue) to configure the media type (H264 / JPEG / MPEG4), file format (AVC / AVI), and record time (1 ~ 5 seconds) for the event video clip. The camera will upload the captured video clip to the FTP site you assigned in "Network" → "FTP" once the selected event type occurs.
SMS	Select the event type you want to receive a text message when it occurs. The camera will send a text message to the mobile phone number you assigned in "Network" → "SMS" once the selected event type occurs.
Alarm Out	Select the event type you want to trigger the alarm-out device to work when it occurs. Then, click the title "Alarm Out" (in blue) to configure the trigger rule (LOW / HIGH).
Record	Select the event type you want to enable event recording when it occurs.
Audio Alert	Select the event type you want to enable audio alert when it occurs.

3.7 General

3.7.1 General

To change the language of UI interface, select from the drop-down list in "Language".

To allow the status LED indicators to show the status as indicated in "1.6 Status Indicator" at page 2, select "Enable" in "Status LED Mode"; to hide the status, select "OFF"; to only show the error status, select "Temporary Disable".

Note: The status LED mode will be restored to "Enable" after camera reboot when "Temporary OFF" is selected.

To lock camera access when it's not used after the specified time, select "5 MIN", "15 MIN" or "30 MIN" from the drop-down list of "Auto Lock Time", or select "NEVER" to disable this function.

Note: When the camera access is locked after the specified time, to resume camera access, please enter the password.

The screenshot shows a web interface titled "General" with a sub-section "General Configuration". It contains four settings, each with a dropdown menu:

- Language: English
- Status LED Mode: Enable
- Auto Lock Time: 15 MIN
- MAC Address: 00:0E:53:E6:29:B3

At the bottom of the configuration area, there are two buttons: "Save" and "Reload".

3.7.2 Time

Set daylight saving time and the current time, and click “Save” to confirm.

Time

Time Configuration

OSD: Enable Disable

Date:

Time: : :

Daylight Saving Time

Daylight Saving Time Configuration

Daylight Saving Time: Enable Disable

Start Time: : (HH:MM)

End Time: : (HH:MM)

Adjust Time: : (HH:MM)

Function	Description
■ Time Configuration	
Date	Set the current date.
Time	Set the current time.
■ Daylight Saving Time Configuration	
Daylight Saving Time	Specify whether to use daylight saving time (Enable / Disable).
	If this function is enabled, set the time period (Start Time / End Time), and adjust the daylight saving time in hours (Adjust Time).

3.7.3 Server Log

To quickly search the system logs you want by event type, click “Prev. Page” or “Next Page” to find the logs you want, or check the event type(s) and click “Reload” to start searching.

To clear all system event logs, click “Clear All”.

Server Log List

No.	Event	Time	Result
1	Remote Login	2011/08/30 20:54:41	admin
2	Remote Login	2011/08/30 20:29:58	admin
3	Remote Login	2011/08/30 18:22:08	admin
4	SNTP Update	2011/08/30 18:20:06	Failed
5	Remote Login	2011/08/30 18:20:03	admin
6	Power On	2011/08/30 18:19:24	ON
7	Power On	2011/08/30 18:18:46	OFF
8	Remote Login	2011/08/30 18:11:21	admin
9	Remote Login	2011/08/30 18:11:18	admin
10	Remote Login	2011/08/30 18:07:10	admin
11	Remote Login	2011/08/30 18:03:19	admin
12	Remote Login	2011/08/30 18:02:15	admin
13	Remote Login	2011/08/30 18:02:07	admin
14	Remote Login	2011/08/30 18:01:51	admin
15	Remote Login	2011/08/30 17:57:01	admin
16	Remote Login	2011/08/30 17:56:55	admin
17	Remote Login	2011/08/30 17:56:53	admin
18	Remote Login	2011/08/30 17:54:44	admin
19	SNTP Update	2011/08/30 17:50:48	Failed
20	Power On	2011/08/30 17:50:07	ON

3.7.4 Online

You can check the current online user(s) with respective online information. To refresh the list, click “Reload”.

- To allow anonymous login, select “Enable” in “Anonymous Viewer Login”.
- To disable image code verification at login, select “No” in “Login with CAPTCHA Image”.

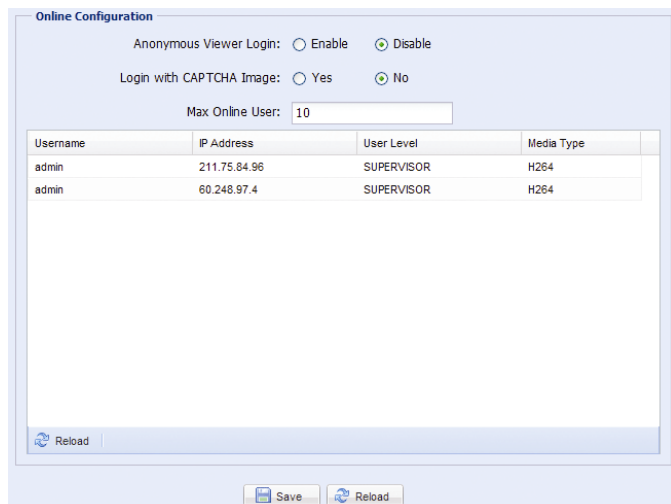

3.7.5 Account

You can create a new account with different user access privilege, or delete or modify an existing account setting.

How to create a new account

Step1: Click “New”, and fill in the following columns.

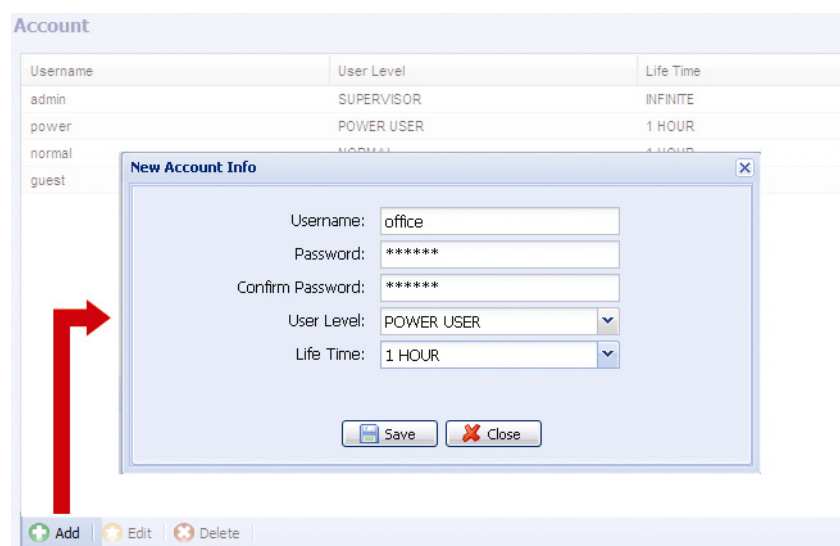

Column	Description
User Name	Set a user name that will be used for camera access. The user name allows up to 16 alphanumeric characters.
Password	Set the password that will be used for remote login. The password allows up to 16 alphanumeric characters.
Confirm Password	Enter the password again to confirm.
User Level	Set the security level of an account to give the permission to control different functions. There are four user levels: SUPERVISOR, POWER USER, NORMAL USER and GUEST.
Life Time	Select how long this account is allowed to stay online (1 MIN / 5 MIN / 10 MIN / 1 HOUR / 1 DAY / INFINITE)

Step2: Then, click “Save” to save your setting and create a new account.

How to modify or delete an existing account

Step1: Select the account you want to modify or delete.

Step2: To modify the account, click “Edit” to change the settings, and click “Save”.

To remove the account, click “Delete”.

Note: It's not allowed to remove an account when there's only one account in the account list.

3.7.6 Google Maps

This function is used to let you know where the network camera is.

The system will prompt you to apply a Google Maps Key if your access is denied. Please follow the instructions below when you're denied:

Step1: Click "Sign up for a Google Maps key" to enter the application page.

Step2: Check the terms and conditions, and enter the IP address of the network camera. Then, click "Generate API Key".

Step3: Copy the generated API key, and click "Update Google Maps Key" on the web browser to paste it.

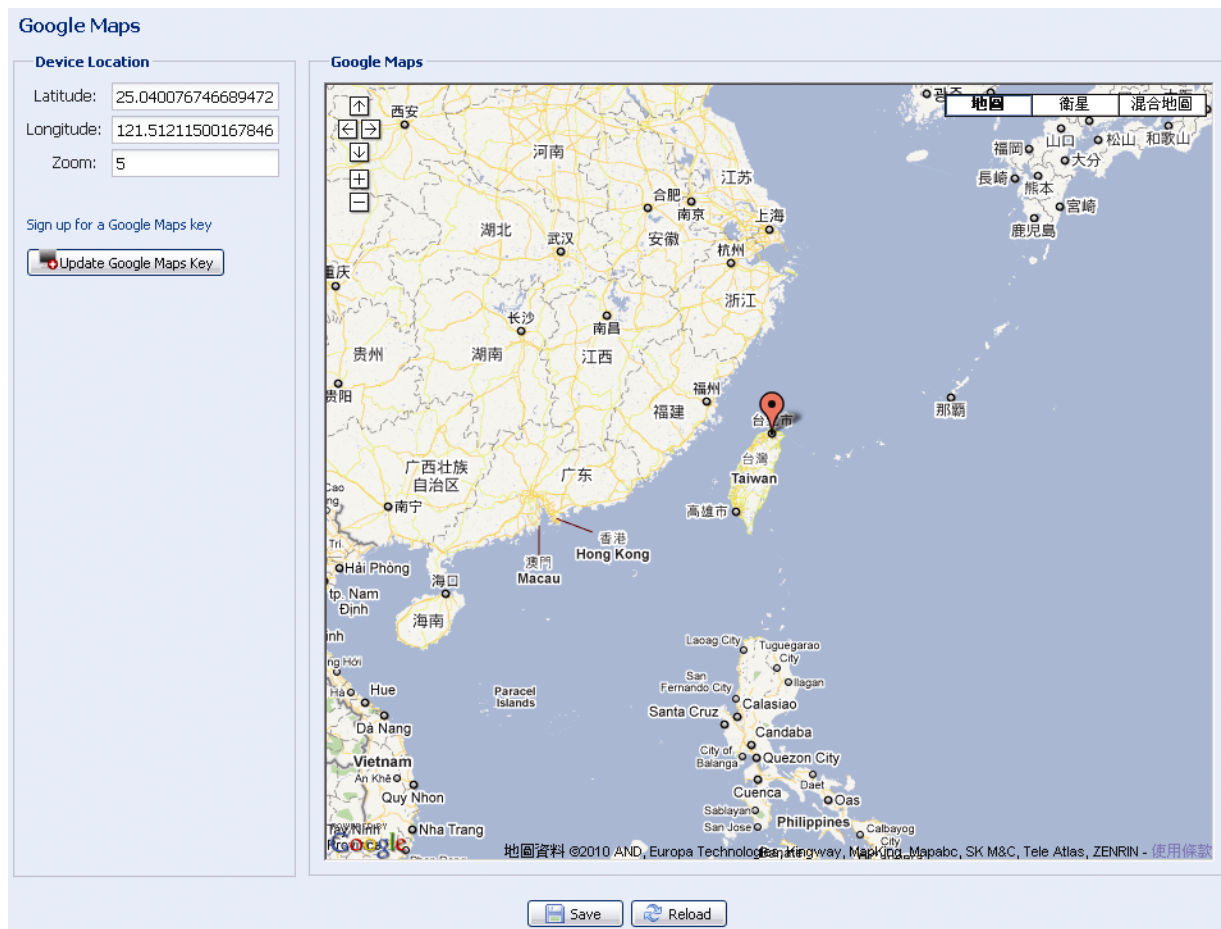

3.7.7 Maintenance

Firmware Upgrade

This function is used when users need to upgrade the camera for function scalability.

Note: Before using this function, make sure you have the correct upgrade files provided by your installer or distributor.

Note: The event videos saved in the camera will be removed after firmware upgrade. Make sure you've copied important events to your PC before firmware upgrade.

Step1: Select "📁" to browse to where you save the upgrade files, and select them one by one until all files are selected (up to four files).

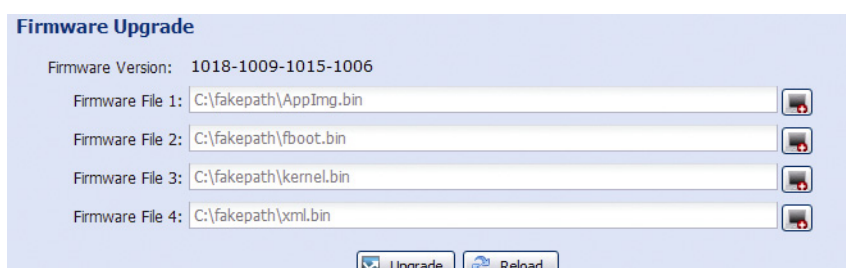

Step2: Select “Upgrade” to start system upgrading.

Note: You’ll be prompted to keep current configurations. It’s recommended to keep them, or all configurations will be restored to default values after upgrade.

Note: It takes a few minutes to finish the upgrade process. Do not disconnect the power during firmware upgrade, or the upgrade may be failed. The camera will reboot after the upgrade.

System Configuration Backup

This function is used to copy your system configuration to a “System.bin” file.

You may import the same system configuration to another camera, or restore your system configuration when the camera is reset to default values.

Select “System.bin” in “Firmware Upgrade”, and select “Upgrade” to import the system configuration.

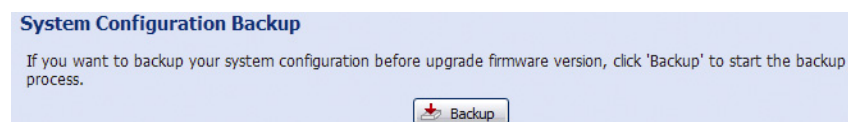

System Reboot

Select “Reboot” to restart your camera if needed.

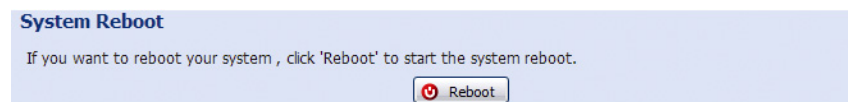

Player Download

To see the event video clips downloaded to your PC, you need to first install our own video player in your PC. Select “Free Download” to download the video player, and double click the file to install it.



APPENDIX 1 PRODUCT SPECIFICATIONS

Model	2 Megapixel	1.3 Megapixel	D1
■ Network			
Network Compression	H.264 / MPEG4 / MJPEG		
Multiple Video Streaming (Encode Modes, IPS, Resolution)	3 (H.264, MJPEG, MPEG4)		
LAN Port	YES		
LAN Speed	10/100 Based-T Ethernet		
Supported Protocols	DDNS, PPPoE, DHCP, NTP, SNTP, TCP/IP, ICMP, SMTP, FTP, HTTP, RTP, RTSP, RTCP, IPv4, Bonjour, UPnP, DNS, UDP, IGMP, QoS		
Frame Rate	30 FPS		
Number of Online Users	10		
Security	<ol style="list-style-type: none"> Multiple user access levels with password IP address filtering Digest authentication 		
Remote Access	<ol style="list-style-type: none"> Internet Explorer on Windows operating system EagleEyes on iPhone, iPad and Android mobile devices 		
ONVIF Compatible	YES		
■ Camera			
Image Sensor	1/2.9" SONY CMOS image sensor	1/4" SONY H.R. image sensor	1/3" H.R. image sensor
Video Resolution	HD1080P / HD720P / VGA / QVGA / QQVGA***	SXGA / HD720P / VGA / QVGA	D1 / CIF
Min Illumination	0.1 Lux / F1.5, 0 Lux (IR LED ON)		
Shutter Speed	--	1 / 60 (1/50) to 1 / 100,000 sec.	
S/N Ratio	More than 48dB (AGC off)		
Lens	f3.8mm / F1.5		
Viewing Angle	83.2°(Diagonal)	62.7°(Diagonal)	80.4°(Diagonal)
IR LED	12 units (10 meters)		
IR Shifter	YES		
White Balance	ATW		
AGC	Auto		
IRIS Mode	AES		
External Alarm I/O	YES		
POE	YES (IEEE 802.3af)		NO
Microphone	YES		
Speaker	YES		
Power Source (±10%)	12V / 1A	12V / 1A	5V / 1A
Operating Temperature	0°C~40°C		
■ Others			
Mobile Surveillance	iPad, iPhone & Android		
Audio Detection	YES		
RTC (real-time clock)	YES		
Motion Detection	YES		
Digital Pan / Tilt / Zoom	YES		NO
Event Notification	FTP / Email / SMS		
Minimum Web Browsing Requirements	<ul style="list-style-type: none"> Pentium 4 CPU 1.3 GHz or higher, or equivalent AMD 256 MB RAM AGP graphics card, Direct Draw, 32MB RAM Windows 7, Vista & XP, DirectX 9.0 or later Internet Explorer 7.x or later 		

* The specifications are subject to change without notice.

** Dimensional tolerance: ± 5mm

*** QQVGA is for mobile surveillance only

APPENDIX 2 BIT RATE TABLE FOR REFERENCE

The data below is for reference only.

The bit rates listed here may vary depending on the resolution, image quality & frame rate you choose, the complexity of your monitoring area, and how often the moving objects show in your monitoring area.

➤ Megapixel Models

Testing Environment

- Place: Office Entrance
- Network translation: H.264
- Camera type: Megapixel camera

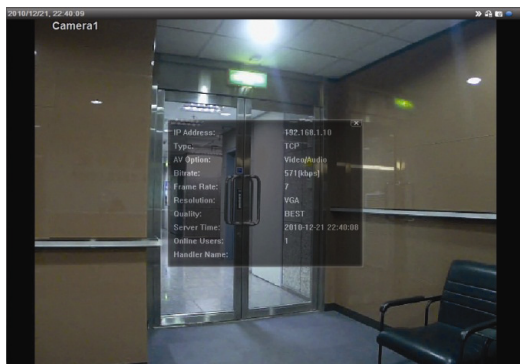

Static: No one coming in and out



Dynamic: One or two people coming in and out

Resolution	Quality	Frame Rate	(Dynamic) kbps	(Static) kbps	
SXGA	Best	FULL	3253	3216	
	High		2375	2160	
	Normal		1571	1266	
	Basic		1465	873	
VGA	Best		2010	1261	
	High		1042	1034	
	Normal		685	572	
	Basic		457	350	
QVGA	Best		646	366	
	High		482	350	
	Normal		302	286	
	Basic		168	161	
SXGA	Best		1/4	1163	1076
	High			989	715
	Normal			855	534
	Basic			719	443
VGA	Best	789		571	
	High	451		447	
	Normal	349		237	
	Basic	217		165	
QVGA	Best	269		147	
	High	182		131	
	Normal	164		113	
	Basic	97		71	

Resolution	Quality	Frame Rate	(Dynamic) kbps	(Static) kbps
SXGA	Best	1/15	581	374
	High		405	342
	Normal		487	248
	Basic		337	141
VGA	Best		358	79
	High		201	63
	Normal		180	28
	Basic		92	15
QVGA	Best		111	84
	High		99	68
	Normal		97	54
	Basic		58	42

➤ D1 Model

Testing Environment

- Place: Office Entrance
- Network translation: H.264



Static: No one coming in and out

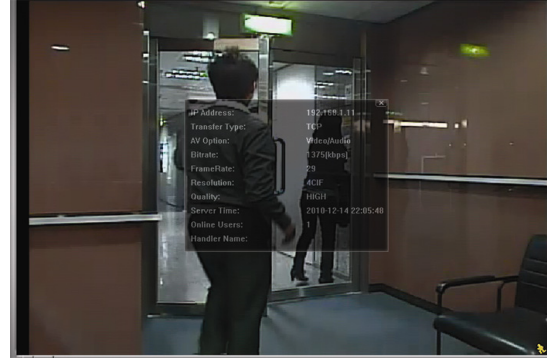

Dynamic: One or two people coming in and out

Resolution	Quality	Frame Rate	(Dynamic) kbps	(Static) kbps
D1	Best	FULL	2786	1546
	High		1375	705
	Normal		1234	425
	Basic		441	245
CIF	Best		955	290
	High		364	171
	Normal		328	111
	Basic		161	68
D1	Best	1/5	935	474
	High		506	272
	Normal		297	175
	Basic		223	108
CIF	Best		222	109
	High		133	67
	Normal		81	49
	Basic		71	32
D1	Best	1/30	127	70
	High		197	20
	Normal		61	11
	Basic		50	4
CIF	Best		42	7
	High		38	2
	Normal		22	1
	Basic		28	0

APPENDIX 3 POE CONNECTION (Megapixel Models Only)

This device supports PoE (Power-over-Ethernet), developed by the IEEE802.3af task force, and power can be supplied over the same network (Ethernet) cable as the one used to connect to Internet. No power cable is needed. Below shows two examples of POE application for reference.

- When your router / hub supports POE connection

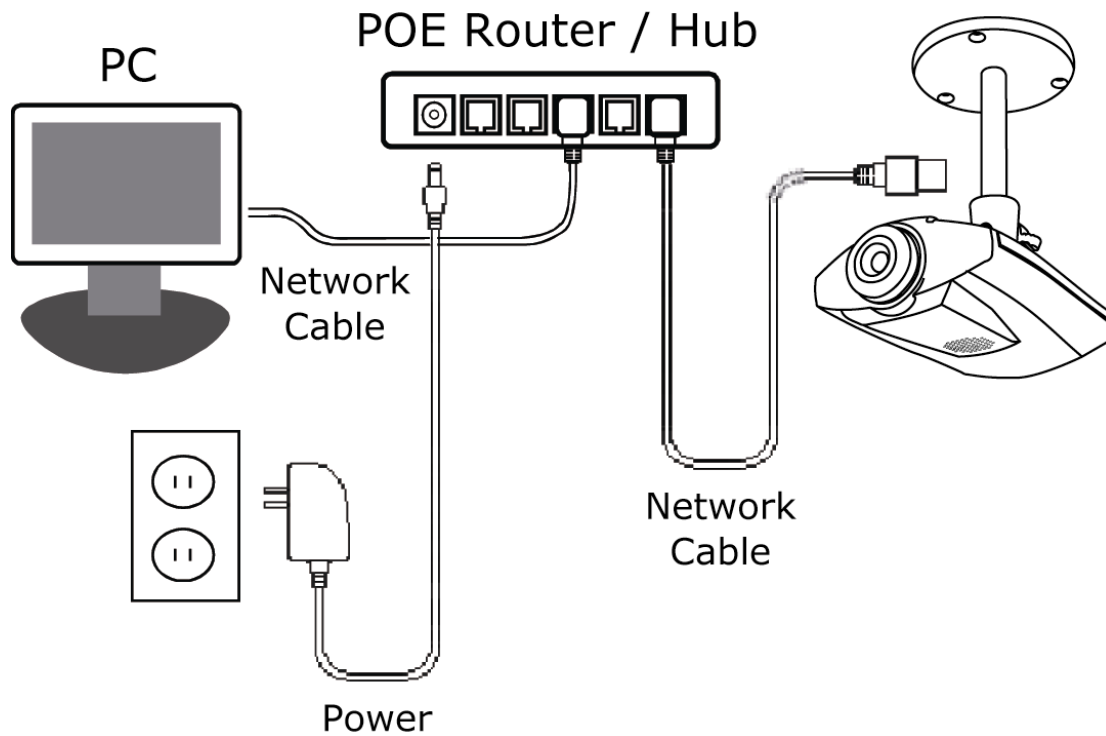

- When your router / hub doesn't support POE connection (An optional POE connected required)

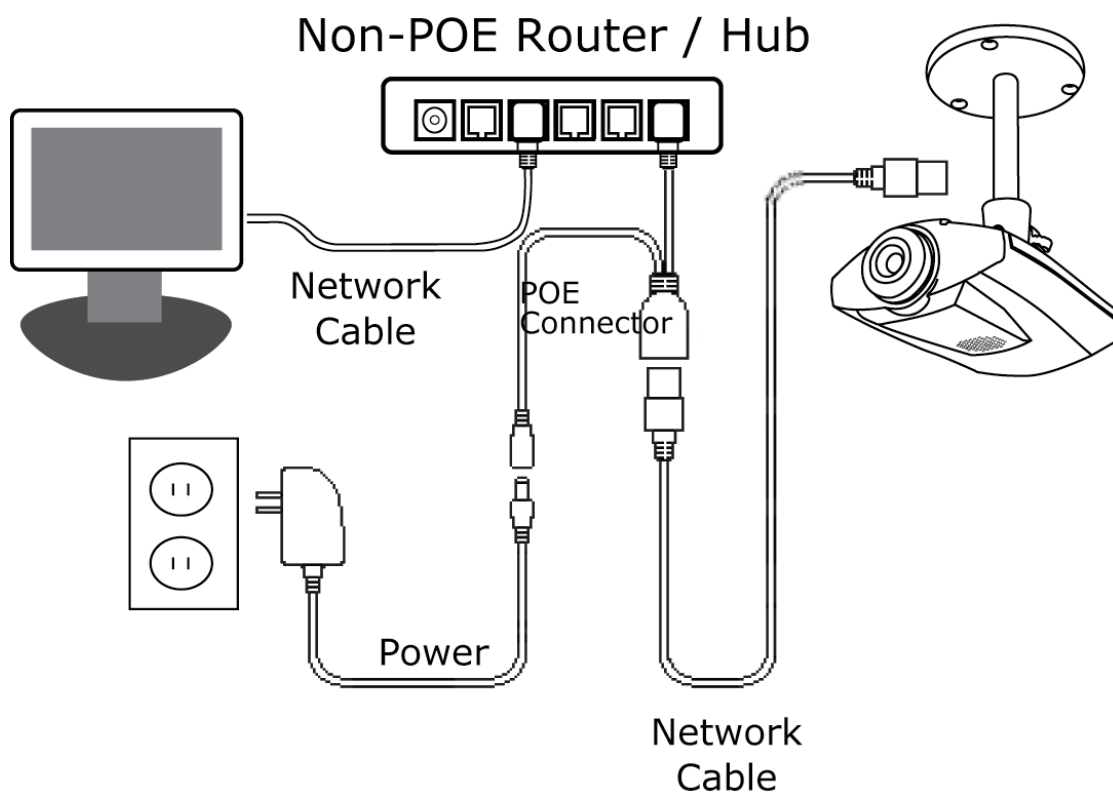

APPENDIX 4 API ID APPLICATION FOR SMS MESSAGING

To allow the camera automatically sending a text message when an event happens, you need to apply an API ID from Clickatell, one mobile messaging company, first.

Note: The SMS messaging is not totally free. You will be charged starting from the 11th message.

Please follow the steps below for application.

Step1: Go to <http://www.clickatell.com/login.php>. In “New Customers”, select “Clickatell Central (API)” from the drop-down list.

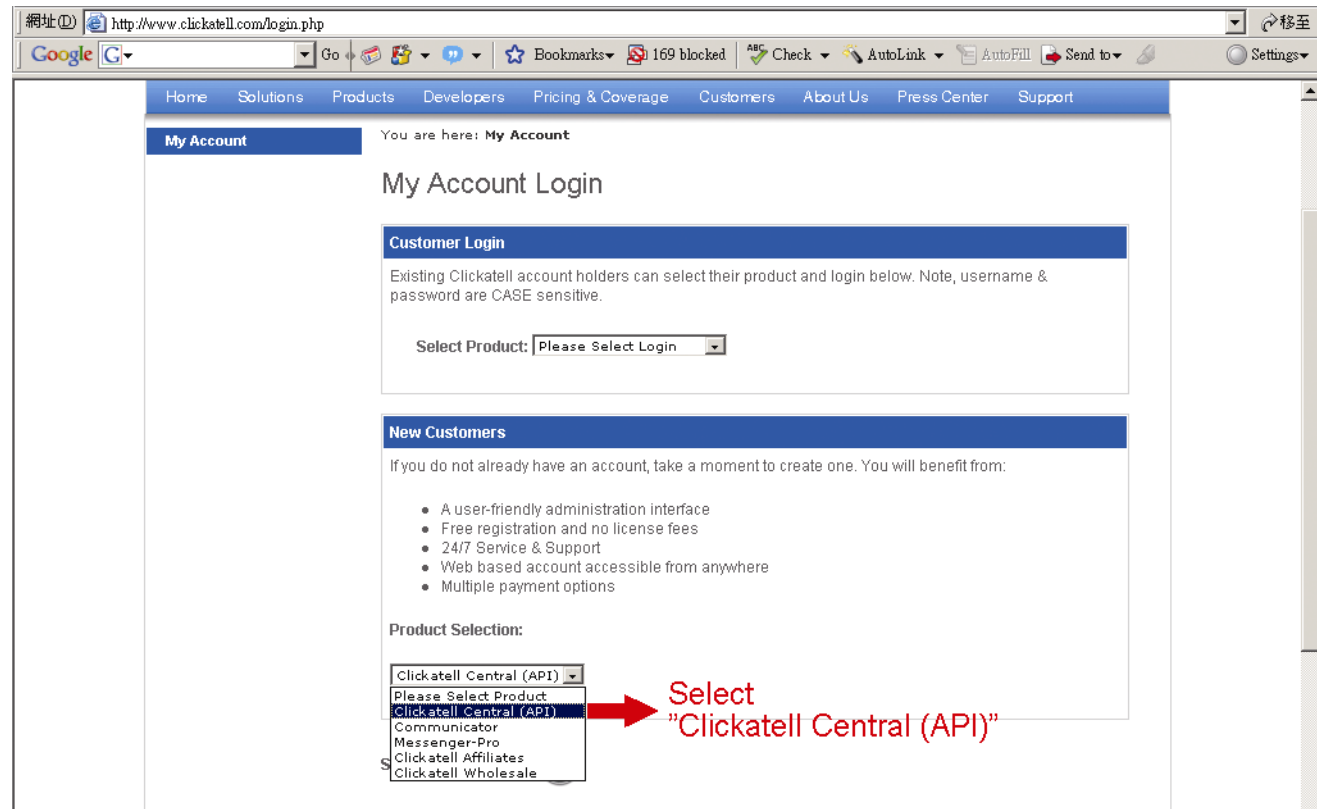

Step2: Fill in your information to create an account, and click “CONTINUE”.

Note: Note down the user name and password, and the mobile phone number you specified here for SMS notification setting later.

Step 1 of 4 - Select Product

Select one of the products below which you would like to register for:

Clickatell Central Communicator

Step 2 of 4 - Account Setup

Select a country specific or International account type, based on your requirements for SMS traffic delivery destinations.

International Coverage Account: INTERNATIONAL Local Coverage Account: USA UK SA IN IE

* Create Username: Security Code: 

* Create Password: *Enter Security Code:

Step 3 of 4 - Personal Information

*First Name: *Country:

*Last Name: *Mobile Number:

*Email Address: (e.g. sample@domain.com)

Personal Use Only:

* Company: Job Description:

Company Size: Industry:

Subindustry:

Emails sent to me must be in Text format or HTML format

Please send me a weekly update of my account balance via email newsletter

* I accept Clickatell's [Terms and Conditions](#)

Step2: When the account is created, the system will automatically send an Email to your specified Email address and ask you to activate your account.

Click the link in the Email to complete account activation, and enter the login page as follows. Enter the password you set, and click “Login”.

My Account Login

Step3: Enter the mobile phone number (including your country code) you want the text message to be sent, and click “SEND ACTIVATION CODE”. The system will send an activation code to that number for verification. Check if you receive a text message from Clickatell.

Step4: Go back to Clickatell, and click the tab “Manage my Products”. Then, select “HTTP” from the drop-down list “My Connections”.

Step5: In “Add HTTP API”, enter a descriptive name for this service, and make sure the dial prefix is correct and callback type is “HTTP GET”. Then, click “Submit”.

Step5: You will get an API ID as follows.

Note: Note down the API ID for SMS notification setting later.

My Connections:

Name	Type	API ID	Dialing Code
IP_SMS	SMTP API	3218637	886 Taiwan
IP_MSG	HTTP	3220810	886 Taiwan

1 to 2 of 2

APPENDIX 5 Q&A

For more details about EagleEyes Q&A, please visit our official website: www.eagleeyesctv.com/supp_QnA.aspx.

Question	Answer
<p>I can connect to this camera in my house or office where it's installed with wireless network.</p> <p>But when I leave my house or office, I can't connect to it from my mobile phone (with 3G network), or other PC (connected to Internet). Why?</p>	<p>You didn't configure this camera to Internet, but only in LAN.</p> <p>Please follow the steps in the advanced network setup guide downloadable from www.surveillance-download.com/user/m317a.swf to complete network configurations, or it's recommended for you to check with your local installer or reseller for this service because it's usually hard for a person who doesn't have network knowledge to set network configurations.</p>
<p>My live images are not fluent. Why?</p>	<p>Image fluency could be affected by the local network upload bandwidth, router efficiency, client network download bandwidth, complexity of live view, and more.</p> <p>(Recommended) To have the best image fluency, select QVGA; to have the best image quality, select "HD1080P" or "SXVGA" based on the model you have; to have normal image fluency and quality, select "VGA".</p>
<p>My image is vague. Why?</p>	<p>The camera might lose its focus. Please rotate the lens to adjust.</p>
<p>The live video keeps flickering. Why?</p>	<p>Please try adjusting the power line frequency to "60 Hz" or "50 Hz" for the camera.</p> <p>For iPhone users, access the camera, and select  on the top right corner to enter IPCAM Configuration page. Then, go to "Advance Setup" → "Camera" to change setting.</p> <p>For access from Internet Explorer, log into the camera, and select "Config." → "Camera" → "Video".</p>

APPENDIX 6 RECORDING TIME TABLE

Below shows the estimated total recording time for each recording resolution.

The recording time per resolution is the average value collected from the both alarm trigger conditions indicated in “Testing Environment”, and is for reference only.

The time may vary depending on the resolution, image quality & frame rate you choose, the complexity of your monitoring area, and how often the moving objects show in your monitoring area.

Testing Environment

- Place: Office
- Monitoring area: 1.5 meters away from the camera
- Alarm trigger conditions:
 - (1) One person walks by the monitoring area and leaves immediately.
 - (2) Two persons walk by the monitoring area. One goes away immediately, and the other one stays a while and goes away.

Recording Resolution	SXGA	VGA	QVGA
Recording time (second)	25	115	211

網路攝影機系列

操作指南

在使用本機前請務必詳細閱讀安全須知及操作說明，並保存此手冊以備後續參考。

安全須知



本公司提供的所有無鉛產品皆符合歐盟有害物質使用限制指引 (Restriction of Hazardous Substances, (RoHS))，意即本公司的生產流程與產品均嚴格遵守無鉛守則，而且不包含該指引內提供的任何有害物質。



此劃叉的滾輪垃圾筒圖示代表在歐盟境內，本產品於丟棄時必須另行收集。此原則適用於您的產品與任何標有此圖示的週邊設備。請勿隨意丟棄這些產品。請洽詢您當地的經銷商，以得知回收此設備的程序。



本裝置製造過程符合無線電干擾要求。

FCC (Federal Communications Commission) 聲明

This equipment has been tested and found to comply with the limits for a Class B digital service, pursuant to Part 15 of the FCC rules. These limits are designed to provide reasonable protection against harmful interference in a residential installation.

Any changes or modifications made to this equipment may void the user's authority to operate this equipment. This equipment generates, uses, and can radiate radio frequency energy. If not installed and used in accordance with the instructions, may cause harmful interference to radio communications. However, there is no guarantee that interference will not occur in a particular installation. If this equipment does cause harmful interference to radio or television reception, which can be determined by turning the equipment off and on, the user is encouraged to try to correct the interference by one or more of the following measures:

- Reorient or relocate the receiving antenna.
- Increase the separation between the equipment and receiver.
- Connect the equipment into an outlet on a circuit different from that to which the receiver is connected.
- Consult the dealer or an experienced radio/TV technician for help.

This device complies with Part 15 of the FCC Rules. Operation is subject to the following two conditions:

- (1) This device must not cause harmful interference, and
- (2) This device must accept any interference received, including interference that may cause undesired operation.

FCC Caution:

- Any changes or modifications not expressly approved by the party responsible for compliance could void the user's authority to operate this equipment.
- All external cables connecting to this basic unit must be shielded.
For cables connecting to PCMCIA cards, see the option manual or installation instructions.

商標聲明

iPad®、iPhone® 是 Apple Inc. 的註冊商標。

Android™ 是 Google Inc. 的商標。此商標的使用必須依 Google Permissions 的規定使用。

Microsoft®、Windows® 和 Internet Explorer® 是 Microsoft Corporation 在美國和 / 或其他國家的註冊商標。

Opera 為 Opera Software 的商標或註冊商標。

免責聲明

本公司保留可隨時修改或刪除說明書內容的任何權利。本公司不保證此說明書的內容完全無誤、完整或實用。此說明書內容更改以實際產品為準，將不另行通知。

本產品不支援待機模式

MPEG-4 授權

THIS PRODUCT IS LICENSED UNDER THE MPEG4 VISUAL PATENT PORTFOLIO LICENSE FOR THE PERSONAL AND NON-COMMERCIAL USE OF A CONSUMER FOR (i) ENCODING VIDEO IN COMPLIANCE WITH THE MPEG4 VISUAL STANDARD ("MPEG-4 VIDEO") AND/OR (ii) DECODING MPEG4 VIDEO THAT WAS ENCODED BY A CONSUMER ENGAGED IN A PERSONAL AND NON-COMMERCIAL ACTIVITY AND/OR WAS OBTAINED FROM A VIDEO PROVIDER LICENSED BY MPEG LA TO PROVIDE MPEG4 VIDEO. NO LICENSE IS GRANTED OR SHALL BE IMPLIED FOR ANY OTHER USE. ADDITIONAL INFORMATION INCLUDING THAT RELATING TO PROMOTIONAL INTERNAL AND COMMERCIAL USES AND LICENSING MAY BE OBTAINED FROM MPEG LA, LLC. SEE [HTTP://WWW.MPEGLA.COM](http://www.mpegla.com).

GPL 授權



This product contains codes which are developed by Third-Party-Companies and which are subject to the GNU General Public License ("GPL") or the GNU Lesser Public License ("LGPL").

The GPL Code used in this product is released without warranty and is subject to the copyright of the corresponding author.

Further source codes which are subject to the GPL-licenses are available upon request.

We are pleased to provide our modifications to the Linux Kernel, as well as a few new commands, and some tools to get you into the code. The codes are provided on the FTP site, and please download them from the following site or you can refer to your distributor:

http://download.dvrtw.com.tw/GPL/076D_Series/arm-linux-2.6.tar.gz

目錄

1. 產品概述.....	1
1.1 產品特點.....	1
1.2 包裝明細.....	1
1.3 產品概觀.....	1
1.4 背板.....	1
1.5 外接 I/O 裝置埠.....	2
1.6 狀態指示燈.....	2
2. 使用 INTERNET EXPLORER 登入攝影機.....	3
2.1 登入攝影機.....	3
2.2 控制面板簡介.....	3
2.3 DPTZ 操作 (僅支援百萬畫素型號).....	5
2.4 錄影事件搜尋與回放.....	6
3. 攝影機設定.....	7
3.1 系統設定選單.....	7
3.2 網路設定.....	8
3.2.1 網路設定.....	8
3.2.2 QoS.....	8
3.2.3 DDNS.....	8
3.2.4 網路對時.....	9
3.2.5 影像上傳.....	9
3.2.6 郵件管理.....	9
3.2.7 SMS.....	10
3.2.8 過濾器.....	11
3.2.9 UPnP / Bonjour.....	11
3.2.10 RTP.....	12
3.3 攝影機設定.....	13
3.3.1 攝影機設定.....	13
3.3.2 影像設定.....	13
3.3.3 顏色設定.....	14
3.3.4 聲音設定.....	14
3.3.5 進階設定.....	14
3.4 定時錄影.....	15
3.4.1 錄影.....	15
3.4.2 定時錄影.....	15
3.5 儲存裝置.....	15
3.5.1 記憶體.....	15
3.6 觸發設定.....	16
3.6.1 觸發設定.....	16
3.7 常用設定.....	17
3.7.1 常用設定.....	17
3.7.2 時間設定.....	18
3.7.3 系統日誌.....	18
3.7.4 連線使用者.....	19
3.7.5 權限管理.....	19
3.7.6 Google 地圖.....	20
3.7.7 系統維護.....	20
韌體更新.....	20
附錄 1 產品規格.....	22
附錄 2 傳輸速度參照表.....	23
附錄 3 連接 POE 功能 (僅支援百萬畫素型號).....	26
附錄 4 如何申請簡訊通知功能的應用程式介面識別碼.....	27
附錄 5 常見問題集.....	29
附錄 6 錄影時間表.....	30

1. 產品概述

1.1 產品特點

- 使用 **iPhone / iPad**，快速完成網路設定
- 支援 **ONVIF** 功能，簡化系統整合
- 支援**外接警報裝置**
- 內建麥克風和擴音器來**收音和擴音**
- **遠端監控**
 - 可由 **iPhone & iPad**，以及 Windows® 作業系統的 **Internet Explorer®** 進行遠端監控
- (僅支援百萬畫素型號) 支援 **Power-over-Ethernet** 功能 (POE)，節省用電量與重新佈線的成本
- (僅支援兩百萬畫素型號) **200 萬畫素**的 LIVE MOS 感應元件並支援 **HDTV 1080p**，讓使用者能看到更細微的內容
- (僅支援 1.3 百萬畫素型號) **130 萬畫素**的 LIVE MOS 感應元件並支援 **HDTV 720p**，讓使用者能看到更細微的內容

1.2 包裝明細

- | | | |
|----------------------------------------------------|-----------------------------------|---------------------------------------|
| <input type="checkbox"/> 網路攝影機 | <input type="checkbox"/> 攝影機支架 | <input type="checkbox"/> 3 PIN/I/O 端子 |
| <input type="checkbox"/> 快速設定指南 (使用 iPhone / iPad) | <input type="checkbox"/> 變壓器 (選購) | |

1.3 產品概觀

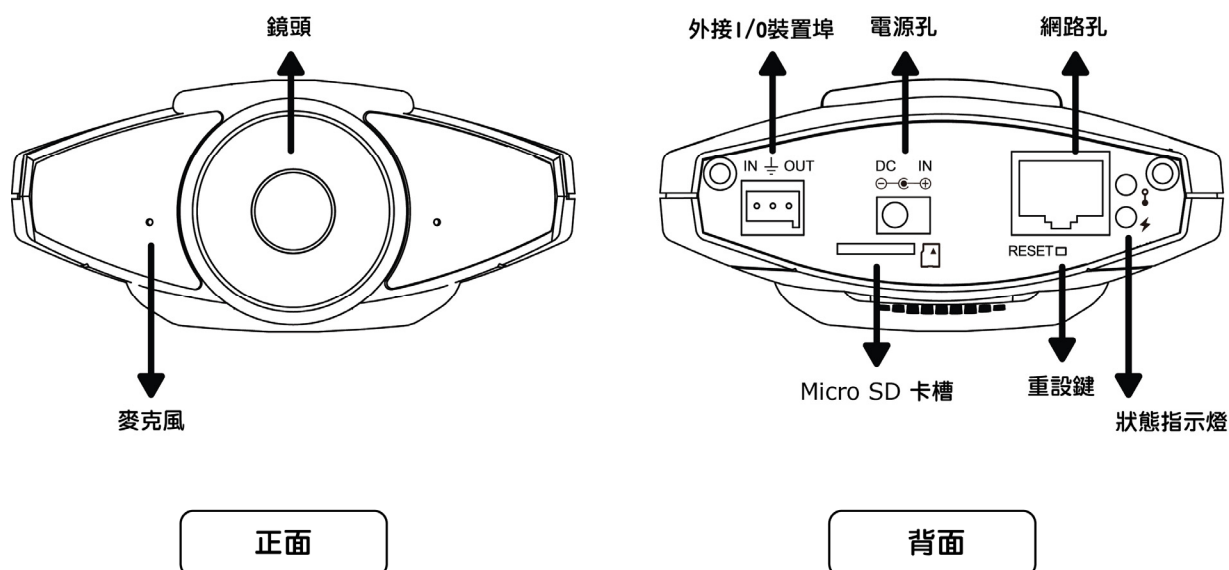

1.4 背板

網路孔：	連接網路線。
電源孔：	插到攝影機規定使用的電源變壓器。 * 變壓器為選購設備，請另外購買。
重設鍵：	在攝影機上電的情況下，長按此鍵會重設所有參數回原廠設定值，包括 IP 位址。 重設完成後，攝影機會重新啓動。請勿在攝影機重設期間拔除攝影機電源。
外接 I/O 裝置埠：	攝影機有隨附一個 3 PIN 的 I/O 端子，專門用來外接警報裝置。詳情請參閱第 2 頁的「1.5 外接 I/O 裝置埠」。
狀態指示燈：	顯示 LAN 區網連線狀態，而  顯示網際網路連線狀態。詳情請參閱第 2 頁的「1.6 狀態指示燈」。

1.5 外接 I/O 裝置埠

攝影機有隨附提供一個 3 PIN 的外接 I/O 端子，讓您可以輕鬆連接到警報裝置。

下圖顯示 I/O 端子各個連接 PIN 腳的用途，以及連接 Alarm Out 裝置的接線示意圖。

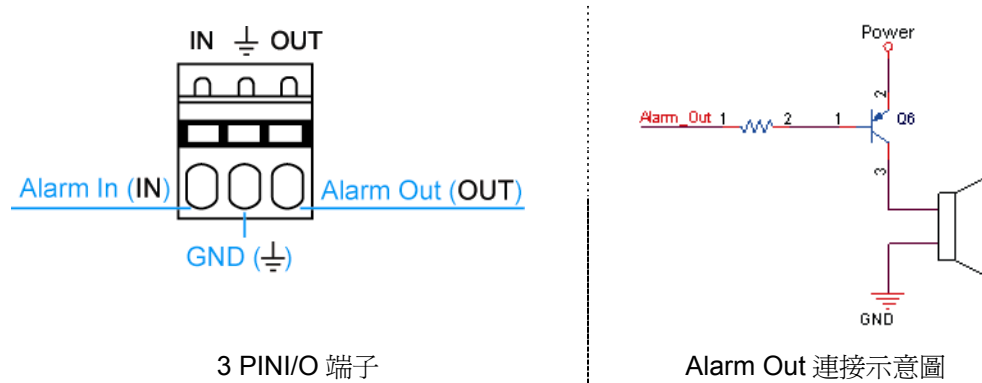

3 PIN I/O 端子

Alarm Out 連接示意圖

1.6 狀態指示燈

圖示	LAN 區網連線狀態	Internet 連線狀態
系統狀態		
在開機時	恒亮	恒亮
回復原廠值	閃爍 (亮 250 毫秒, 滅 250 毫秒) ●○○●○○●○○●○○	恒滅
升級	閃爍 (亮 250 毫秒, 滅 250 毫秒) ●○○●○○●○○●○○	閃爍 (亮 250 毫秒, 滅 250 毫秒) ●○○●○○●○○●○○
連線狀態		
區網已連線	恒亮	--
區網斷線	閃爍 (亮 100 毫秒, 滅 500 毫秒) ●○○●○○●○○	--
Internet 已連線	--	恒亮
Internet 斷線	--	閃爍 (亮 100 毫秒, 滅 500 毫秒) ●○○●○○●○○
3G 連線錯誤 (iPhone / iPad / Android 行動裝置)		
3G 連線設定未完成	--	閃爍 (亮 5 秒、滅 0.5 秒、亮 0.5 秒、滅 0.5 秒、亮 5 秒) ●●●●○○●●●●

* LED 燈閃爍頻率示意 - ● LED 燈亮 / ○ LED 燈滅

2. 使用 INTERNET EXPLORER 登入攝影機

視您的使用環境而定，您可以使用 Microsoft® Internet Explorer® 登入此攝影機，或者在 iPhone / iPad / Android 行動裝置安裝本公司研發的行動小程序 EagleEyes 來進行登入。

註：如需得知使用 iPhone / iPad / Android 行動裝置登入此攝影機的詳細資訊，請參閱 <http://www.eagleeyesccvt.com>。

在使用此攝影機之前，請先確認您已做好網路設定，而且網路連線正常。

如需得知網路設定的相關資訊，請參閱：

- 隨附攝影機提供的「快速設定 (使用 iPhone / iPad)」– 若您有 iPhone / iPad，而且您是使用無線網路來上網
- 「進階網路設定」，可從 www.surveillance-download.com/user/m317a.swf 下載 – 若您不是使用無線網路來上網

2.1 登入攝影機

步驟 1：開啓您的網路瀏覽器，然後在位址列輸入 [http://IP 位址:埠號](http://IP位址:埠號)。

舉例來說，若 IP 位址為 60.121.46.236 且埠號為 888，請在 URL 網址列中輸入 <http://60.121.46.236:888>，然後按 Enter。

步驟 2：在登入頁面中，輸入預設的使用者名稱和密碼，然後輸入下圖顯示的驗證碼。接著，按 [LOGIN] 登入。

步驟 3：設定精靈隨即啓動。

- 若要離開精靈並直接登入攝影機，請按 [關閉]。
- 若不要在每次登入時都啓動精靈，而是直接進入攝影機畫面，請按 [登入時不啓動精靈]。

註：若系統要求您安裝「VLC player」、「Software」和「H264 Streaming Viewer」，請同意完成安裝。

步驟 5：登入成功後就會看到即時畫面。

2.2 控制面板簡介

註：視登入權限的不同，可使用的按鈕也會不同。

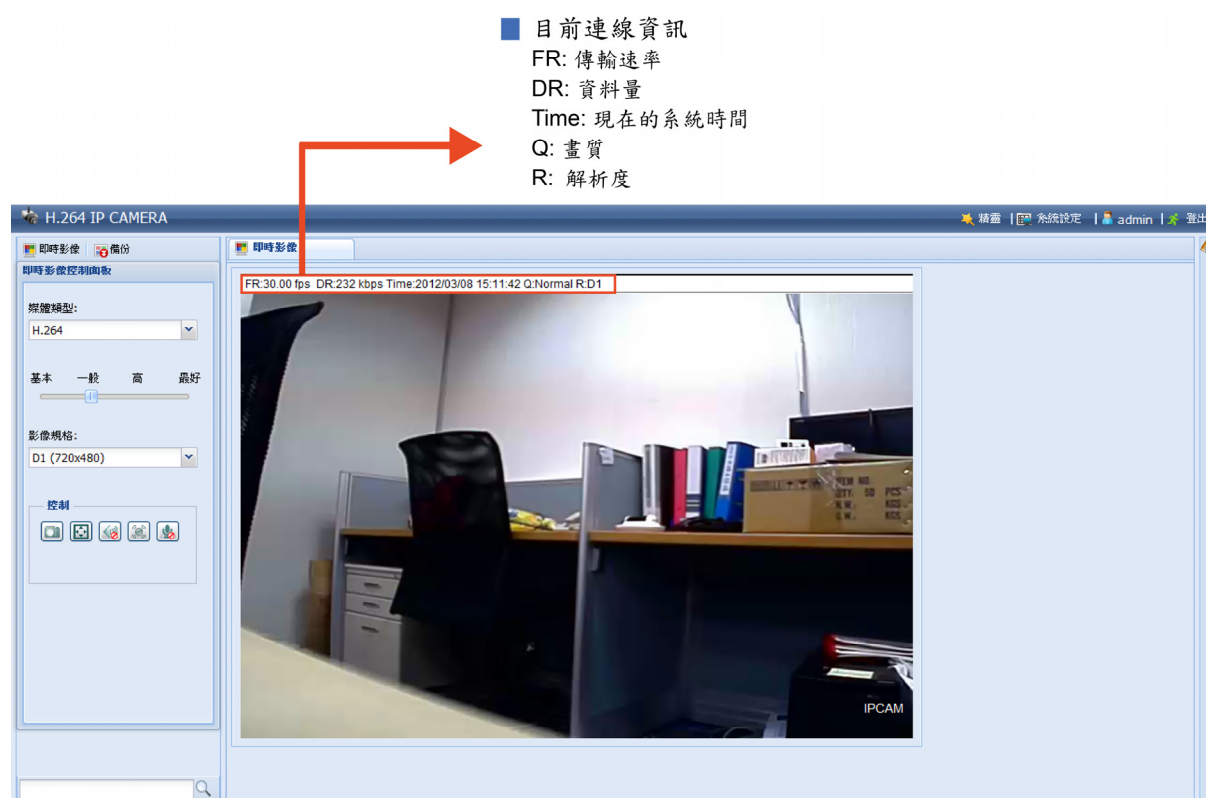

功能	圖示	使用者權限	說明															
即時影像		系統使用者 / 超級使用者 / 一般使用者 / 訪客	切換到即時影像頁面。															
備份		系統使用者 / 超級使用者	進入事件錄影清單，搜尋要播放的錄影檔案。 詳情請參閱第 6 頁的「2.4 錄影事件搜尋與回放」。															
DPTZ*		系統使用者 / 超級使用者 / 一般使用者	切換到 DPTZ 設定頁面。 詳情請參閱第 5 頁的「2.3 DPTZ 操作 (僅支援百萬畫素型號)」。															
系統設定		系統使用者	切換到系統設定頁面；使用「系統使用者」和「超級使用者」登入時看到的功是是不同的。 詳情請參閱第 7 頁的「3.1 系統設定選單」。															
即時播放器	--	系統使用者 / 超級使用者 / 一般使用者 / 訪客	從下拉式清單選擇播放軟體： <ul style="list-style-type: none"> ■ H.264 / MPEG-4 / Motion JPEG ■ QuickTime <p>QuickTime 是 Apple 公司的多媒體播放軟體。在選取 QuickTime 之前，您必須先將 QuickTime 安裝到您的作業系統。選取 QuickTime 後，系統會提示您輸入使用者名稱和密碼來登入攝影機。</p> <ul style="list-style-type: none"> ■ VLC 															
影像品質	--	系統使用者 / 超級使用者 / 一般使用者	按住並拖曳滑桿來選取影像畫質：低 / 一般 / 高 / 最好。															
影像規格	--	系統使用者 / 超級使用者 / 一般使用者	從下拉式選單選取影像解析度： <table border="1" style="width: 100%; border-collapse: collapse;"> <thead> <tr> <th style="text-align: left;">200 萬畫素型號</th> <th style="text-align: left;">130 萬畫素型號</th> <th style="text-align: left;">D1 畫素型號</th> </tr> </thead> <tbody> <tr> <td>■ HD1080P (1920 x 1080)</td> <td>■ SXGA (1280 x 1024)</td> <td>■ D1 (720 x 480)</td> </tr> <tr> <td>■ HD720P (1280 x 720)</td> <td>■ HD720P (1280 x 720)</td> <td>■ CIF (352 x 240)</td> </tr> <tr> <td>■ VGA (640 x 480)</td> <td>■ VGA (640 x 480)</td> <td>■ CIF (352 x 240)</td> </tr> <tr> <td>■ QVGA (320 x 240)</td> <td>■ QVGA (320 x 240)</td> <td></td> </tr> </tbody> </table>	200 萬畫素型號	130 萬畫素型號	D1 畫素型號	■ HD1080P (1920 x 1080)	■ SXGA (1280 x 1024)	■ D1 (720 x 480)	■ HD720P (1280 x 720)	■ HD720P (1280 x 720)	■ CIF (352 x 240)	■ VGA (640 x 480)	■ VGA (640 x 480)	■ CIF (352 x 240)	■ QVGA (320 x 240)	■ QVGA (320 x 240)	
200 萬畫素型號	130 萬畫素型號	D1 畫素型號																
■ HD1080P (1920 x 1080)	■ SXGA (1280 x 1024)	■ D1 (720 x 480)																
■ HD720P (1280 x 720)	■ HD720P (1280 x 720)	■ CIF (352 x 240)																
■ VGA (640 x 480)	■ VGA (640 x 480)	■ CIF (352 x 240)																
■ QVGA (320 x 240)	■ QVGA (320 x 240)																	
即時影像顯示方式		系統使用者 / 超級使用者 / 一般使用者																
全螢幕			按此鈕來全螢幕顯示影像。 若要離開全螢幕顯示，請按一下鍵盤上的 [Esc] 鍵。 當選取的影像規格為 SXGA / HD720P / HD1080P / VGA / D1 時，才能使用此功能。															
CIF 調整大小			QVGA 影像大小已被重新調整以符合螢幕尺寸。 當選取的影像規格為 QVGA 或 CIF 時，才能使用此功能。															
原來大小			目前影像大小與選取的影像規格相符。 當選取的影像規格為 SXGA / HD720P 或 HD1080P，才能使用此功能。															
符合螢幕大小			選取的影像大小已被重新調整以符合螢幕尺寸。 當選取的影像規格為 SXGA / HD720P 或 HD1080P，才能使用此功能。															
拉框檢視			按住即時影像左下角的可移動方框來移動畫面。 當選取的影像規格為 SXGA / HD720P 或 HD1080P，才能使用此功能。															
快照		系統使用者 / 超級使用者 / 一般使用者	截取即時影像的畫面；影像檔會顯示於新視窗，按右鍵點選圖像，將圖像儲存在您指定的位置。															
聲音開 / 關		系統使用者 / 超級使用者 / 一般使用者	開啓或關閉收音功能。															
警報發出		系統使用者 / 超級使用者 / 一般使用者	強制警報裝置啓動。例如，若您連接了一台蜂鳴器，一旦按下此鈕，就算沒有發生警報，警鳴器也會放聲大響。															
麥克風		系統使用者	開啓或關閉擴音功能。															



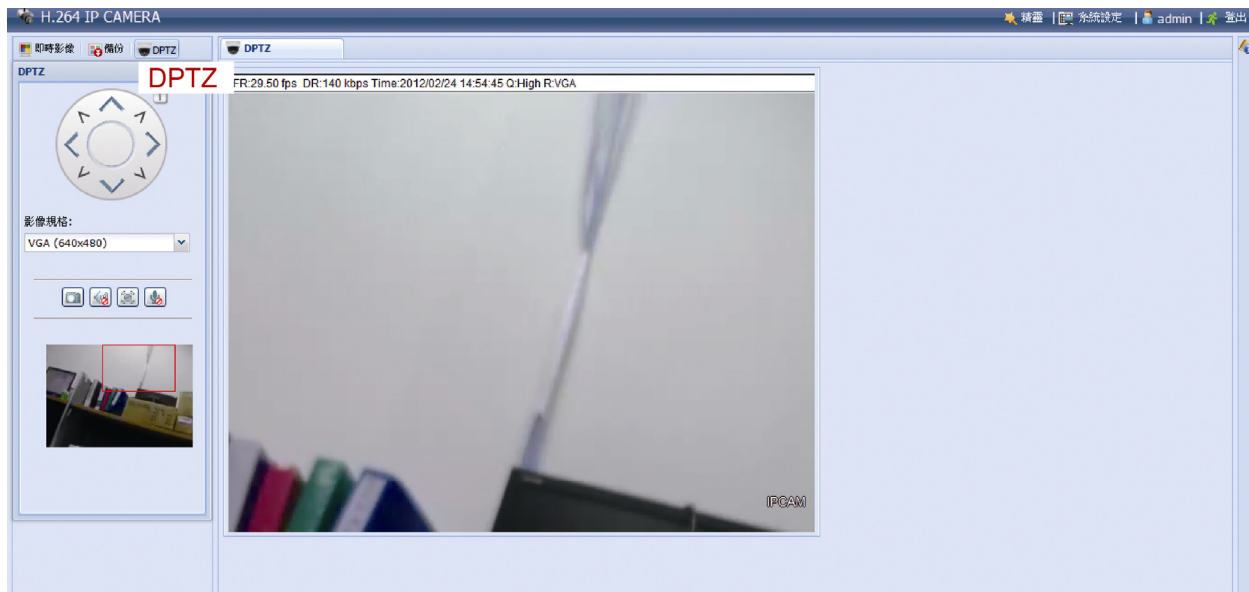

2.3 DPTZ 操作 (僅支援百萬畫素型號)

此攝影機擁有所謂的數位 PTZ 功能 (之後都稱「DPTZ」)，讓使用者能看到更清楚的畫面。

步驟 1：按 [DPTZ] 顯示 DPTZ 控制面板。



步驟 2：選擇您想使用的功能：







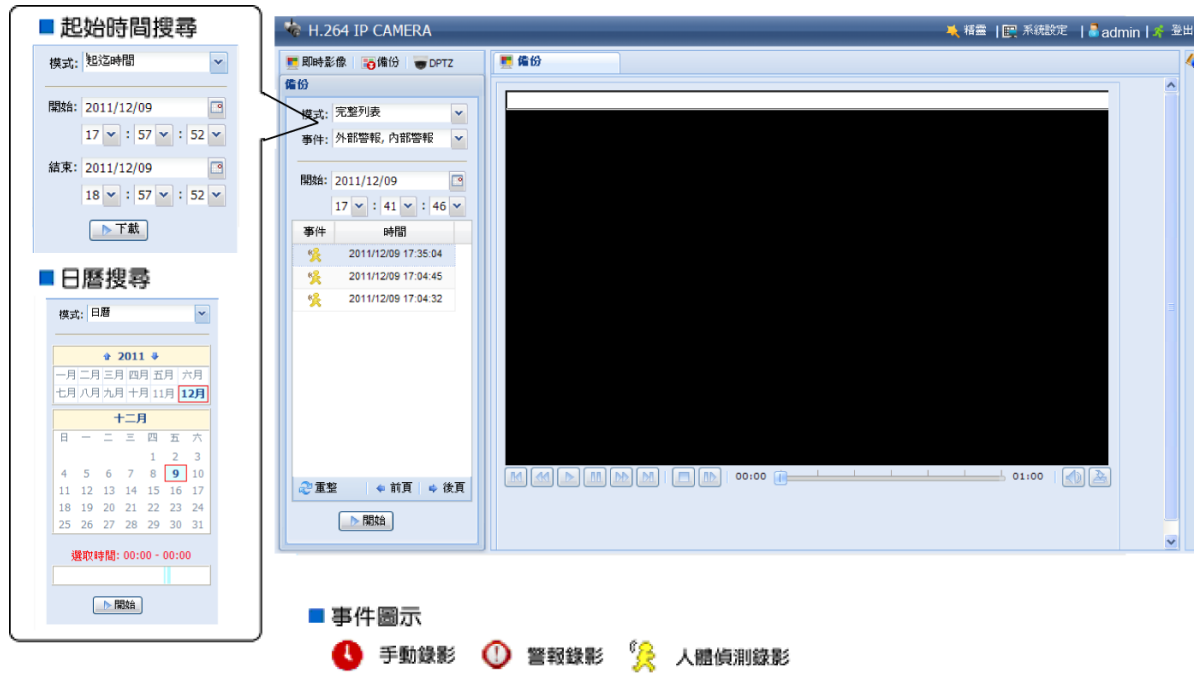

功能	圖示	說明
解析度	--	選擇 DPTZ 功能的影像解析度，包括 VGA 及 QVGA 選項。
快照		截取即時影像的畫面；影像檔會顯示於新視窗，按右鍵點選圖像，將圖像儲存在您指定的位置。
收音 開啓 / 關閉	 /	點選此按鈕切換開啓或關閉收音功能。
警報發出		強制警報裝置啓動。例如，若您連接了一台蜂鳴器，一旦按下此鈕，就算沒有發生警報，警鳴器也會放聲大響。
麥克風	 /	開啓或關閉擴音功能。 唯系統使用人可切換此功能。

2.4 錄影事件搜尋與回放

此攝影機最多可以儲存三筆警報錄影事件。

註：若想要儲存更多錄影資料，建議可搭配相同的 NVR 使用。



	往前一小時 / 往後一小時	往前或往後一小時，例如 11:00 ~ 12:00 或 14:00 ~ 15:00，並開始播放在該時段最早的錄影資料。
	快轉	增加快轉的速度。點一次以 4 倍的速度快轉，兩次 8 倍，以此類推，最高速為 16 倍。
	倒轉	增加倒轉的速度。點一次以 4 倍的速度倒轉，兩次 8 倍，以此類推，最高速為 16 倍。
	播放	播放目前的錄影片段。
	暫停	暫停影片播放。
	停止	停止影片播放。
	單張播放	在暫停影片播放時，按一下格放前進一張影像。
	聲音	必要時，點一下關閉回放畫面內的錄音播放關閉，再點一下即可恢復。
	備份	將目前播放的錄影片段儲存在電腦的指定位置。 下載的影片只能使用我們專用的影片播放程式開啟。您可以從 [常用設定] → [系統維護] 下載此程式，或者從隨附的光碟裡取得。

3. 攝影機設定

使用者可以透過 Internet Explorer 登入攝影機進行更多設定。

3.1 系統設定選單

按 [系統設定] 進入設定頁面。

系統設定選項分成六個主要目錄選單：「網路設定」、「攝影機設定」、「定時錄影」、「儲存裝置」、「觸發設定」和「常用設定」。

- 如需得知「網路設定」的相關資訊，請參閱第 8 頁的「3.2 網路設定」。
- 如需得知「攝影機設定」的相關資訊，請參閱第 13 頁的「3.3 攝影機設定」。
- 如需得知「定時錄影」的相關資訊，請參閱第 15 頁的「3.4 定時錄影」。
- 如需得知「儲存裝置」的相關資訊，請參閱第 15 頁的「3.5 儲存裝置」。
- 如需得知「觸發設定」的相關資訊，請參閱第 16 頁的「3.6 觸發設定」。
- 如需得知「常用設定」的相關資訊，請參閱第 17 頁的「3.7 常用設定」。

主選單	子選單	說明
網路設定	網路設定	設定網路連線。
	頻寬控制	啟動頻寬限制。
	DDNS	若使用的網路類型為 PPPOE 或 DHCP，需輸入 DDNS 資訊。
	網路對時	將攝影機的時間和網路電腦系統同步化。
	影像上傳	若在 [觸發設定] → [觸發設定] 裡選擇 [FTP]，需在此輸入 FTP 資訊。
	郵件管理	若在 [觸發設定] → [觸發設定] 裡選擇 [E-Mail]，需在此輸入 E-Mail 資訊。
	簡訊通知	若在 [觸發設定] → [觸發設定] 裡選擇 [SMS]，需在此輸入簡訊資訊。
	過濾器	選擇要允許或封鎖能登入此攝影機的 IP 位址。
	UpnP	* 適用於 Windows 操作系統 允許在相同網域下的其他裝置能偵測得到這隻攝影機並可快速使用。
	Bonjour	* 適用於 Mac 操作系統 Bonjour 是一項能夠在區網自動設定並偵測特定的網路服務。
RTP	如使用網頁瀏覽器及 Video Viewer 之外的媒體平台，進行遠端監控，須設定影像傳輸速率的參數。	
攝影機設定	攝影機設定	1. 設定攝影機名稱。 2. 變更攝影機名稱在螢幕上顯示的位置。
	影像設定	調整不同影像格式的相關影像設定。
	顏色設定	調整色彩效能。
	聲音	調整收音和擴音的音量。
	進階設定	調整攝影機參數。
定時錄影	錄影	設定錄影功能。
	定時錄影	預約外接警報錄影時間。
儲存裝置	SD 記憶卡	查看記憶卡容量，還可清除所有錄影資料。

主選單	子選單	說明
觸發設定	觸發設定	<ol style="list-style-type: none"> 1. 啟動 / 關閉 位移偵測功能。 2. 設定位移偵測範圍。 3. 設定攝影機在遇到各個事件時的回應。
常用設定	常用設定	<ol style="list-style-type: none"> 1. 選擇語言。 2. 查看攝影機的 MAC 位址。 3. 設定攝影機在指定時間過後自動上鎖禁止存取。
	時間設定	設定日光節約時間和目前的時間。
	系統日誌	查看系統事件日誌。
	連線使用者	查看目前的線上使用者資訊。
	權限管理	<ol style="list-style-type: none"> 1. 建立具有不同存取權限的使用者帳號。 2. 修改或刪除現有使用者帳號。
	Google 地圖	查看目前攝影機所在位置。
	系統維護	<ol style="list-style-type: none"> 1. 查看目前的韌體版本與升級。 2. 複寫系統相關設定。 3. 重新啟動攝影機。 4. 下載影片播放器播放影片。

3.2 網路設定

3.2.1 網路設定

依您的網路類型而定，在此可設定攝影機的網路設定。

詳情請參閱「進階網路設定」，請由 www.surveillance-download.com/user/m317a.swf 下載。

3.2.2 QoS

頻寬控制設定 (Quality of Service)，是一種控制機制，它提供了針對不同使用者或者不同資料流採用相應不同的優先順序，或者是根據應用程式的要求，保證資料流的效能達到一定的水準。勾選 [開啓]，設定最大上傳速率，設定範圍可從每秒 256 位元 到 10240 位元。

3.2.3 DDNS

若在 [網路設定] 選取的網路類型為 [PPPOE] 或 [DHCP]，請選擇 [開啓]。

詳情請參閱「進階網路設定」，請由 www.surveillance-download.com/user/m317a.swf 下載。

DDNS設定

DDNS: 開啟 關閉

系統名稱: default

主機名稱: MAC000e5320d47c .ddns.eagleeyes.tw

E-Mail: manager@tech.com

3.2.4 網路對時

網路對時是用來同步化攝影機和網路電腦系統的時間。

網路對時設定

GMT: (GMT+08:00) Taipei

NTP伺服器: tock.stdtime.gov.tw

同步週期: 每天

主機時間: 2011-12-09 20:56:21

功能	說明
GMT	只要選好時區，網路攝影機就會自動調整系統的本機時間。
NTP 伺服器	您可以選擇保留預設的 SNTP 伺服器 (例如，tock.stdtime.gov.tw)，或者改成您知道的其他伺服器。
同步週期	選擇“每天”將每天的網路時間同步到攝影機，或選擇“無”來關閉此功能。
時間同步	按此按鈕後，網路攝影機的時間即會與網路時間同步。

3.2.5 影像上傳

輸入詳細的 FTP 資訊，然後按 [儲存] 確認。在 [觸發設定] → [觸發設定] 選取 [FTP] 時，則會套用設定於此的功能。

影像上傳設定

帳號: manager

密碼: ●●●●●●

主機名稱: 192.168.2.32

埠號: 21

路徑: upload

3.2.6 郵件管理

輸入詳細的電子郵件資訊，然後按 [儲存] 確認。在 [觸發設定] → [觸發設定] 選取 [E-Mail] 時，則會套用設定於此的功能。

SMTP設定

郵件主機名稱: ms.tech.com

埠號: 465

寄件人信箱: manager

SSL加密: 是 否

密碼驗證: 是 否

帳號: manager

密碼: ●●●●●●

收件人信箱清單

收件人信箱:

收件人	收件人信箱
boss	boss@tech.com

功能	說明
郵件主機名稱	輸入您從電子郵件系統供應商取得的 SMTP 伺服器位址。
埠號	輸入您從電子郵件系統供應商取得的埠號。若沒有填寫此欄，則會預設使用 25 做為傳送郵件的埠號。
寄件人信箱	輸入寄件人名稱。
SSL 加密	如果您是使用 SSL 加密協定來防止重要的資訊遭到攔截，請選擇“是”。
密碼驗證	有些郵件伺服器需要驗證密碼。請輸入【帳號】和【密碼】。
收件人信箱	新增指定收件人的電子郵件位址。
測試	當您輸入完所有資料，請點選【測試】來確認是否可以收到訊息。

3.2.7 SMS

註：開啓此功能前，須先從簡訊通知系統供應商 Clickatell，取得應用程式介面辨別碼。簡訊通知功能的費用自第十一封簡訊起算，詳請參閱第 27 頁的「附錄 4 如何申請簡訊通知功能的應用程式介面識別碼」。

設定簡訊通知系統需輸入詳細資訊，然後按【儲存】確認。在【常用設定】→【觸發設定】選取【FTP】時，您所輸入的資訊則會套用設定於此的功能。

功能	說明
系統商	簡訊通知系統商為 Clickatell。
帳號 / 密碼	輸入帳號密碼。
應用程式介面辨別碼	輸入應用程式介面辨別碼。
接收電話號碼	點選【新增】輸入電話號碼。完整號碼須包含國碼，最多可新增五組號碼。
發送間隔	設定簡訊發送間距時間 (分)，可選擇 0 / 15 / 30 / 60 分鐘。
重新計數	點選此鍵更新簡訊通知功能，之後的簡訊通知將依您所設定的間隔時間傳送。
訊息內容	輸入您想傳送的簡訊內容。(至多七十個字元)
測試	測試您的簡訊通知設定是否正確，按一下【測試】立即傳送訊息至手機。 註：此測試功能並非免費提供，簡訊通知費用將依各地費率計費。

3.2.8 過濾器

選擇要允許或封鎖能登入此攝影機的 IP 位址，然後按 [儲存] 確認。

功能	說明
■ 過濾器設定	
錯誤次數	設定登入失敗的最大可接收次數。登入失敗次數達到設定上限後，該 IP 位址就會被封鎖。
錯誤封鎖時間	設定被封鎖的 IP 位址，要被封鎖多久時間。
回應要求	選擇 [不封鎖] 讓其他使用者可以 ping 到此網路攝影機的 IP 位址，而選擇 [封鎖] 則可拒絕回覆 ping 指令。
■ IP/MAC 過濾設定	
IP/MAC 過濾	選擇要啟用或停用過濾器功能。
IP/MAC 過濾方法	若選擇 [開啟]，請確認要允許或拒絕指定的 IP 位址。
■ IP/MAC 過濾條件	
條件	<ul style="list-style-type: none">若要新增 IP 位址，請在 [條件] 輸入 IP 位址，然後按 [新增]。若要刪除現有 IP 位址，先點選要刪除的位址，然後按 [刪除]。

3.2.9 UPnP / Bonjour

UPnP 為 Universal Plug and Play (通用隨插即用) 的縮寫，即允許此裝置可以在家用與企業的網路環境中被偵測與使用，且可簡化安裝與設定流程，且只適用在 Windows 作業系統。

Bonjour 在功能面和 UPnP 完全一樣，不過 Bonjour 只適用在 Mac 作業系統。

➤ UPnP

➤ Bonjour

勾選 [開啟] 讓此攝影機可以在同網域下被偵測到，並將您的 [裝置名稱] 設定為好記的名稱。

啟用此功能後，其他與此攝影機位在相同網域下的電腦就可在 [網路上的芳鄰] 搜尋到此攝影機。

- 在 Windows 作業系統環境下，請將 [網路芳鄰] 和 [裝置名稱] 皆設定為好記的名稱。
- 在 Mac 作業系統環境下，請將 “” (finder) 或是 “Bookmark” 及 [裝置名稱] 皆設定為好記的名稱。

連按兩下找到的攝影機，即可快速開啓網路瀏覽器並進入登入頁面。

埠號轉址設定 (前提須支援 UPnP)

依此功能，您不需要額外進入 Router，也可設定埠號轉址。

詳情請參閱「進階網路設定」，請由 www.surveillance-download.com/user/m317a.swf 下載。

註：在使用此功能之前，請先確認您的 Router 有支援 UPnP，而且此功能已開啓。如果沒有，您就還是要另外進入 Router 設定埠號轉址。

將 [埠號轉址] 設為 [開啓] 後，若沒有特別指定 [路由器 IP] 或 [HTTP 埠號]，系統就會自動偵測一組 IP 位址或指定一個埠號給您使用。



註：當設定成功時，您會在此頁面看到分配給此攝影機的 IP 位址和埠號。

3.2.10 RTP

RTP (Real-time Transport Protocol) 為一網路協定，用以管理多點傳播的即時傳輸，VLC 播放器即為一例。

在使用媒體播放器進行遠端登入時，請先確認您的播放器有支援 RTP

註：如欲關閉遠端登入，先點選媒體播放器的停止鍵，然後關閉程式。此可確認伺服器收到停止命令，也可避免重複的資料傳輸。



功能	說明
■ 埠號範圍	RTP 的埠號範圍有限，且起始埠號和終點埠號之間須保持 100 組的埠號。
起始埠號	起始埠號的範圍為 1024 到 65434。
終點埠號	終點埠號的範圍為 1124 到 65534。
■ 多點傳播	

功能	說明
H264 / MPEG4 / JPEG 傳輸的位址與埠號	設定多點傳輸內個別影像格式 (H264/ MPEG4/ JPEG) 的位址與埠號。 位址的設定範圍 224.0.0.1 ~ 239.255.255.255。 埠號必須為偶數。
聲音傳輸的位址與埠號	設定多點傳輸內聲音的位址與埠號。 位址的設定範圍 224.0.0.1 ~ 239.255.255.255。 埠號必須為偶數。
存活時間 (TTL)	存活時間的範圍為 1 到 255，當存活時間歸零就會斷線。

3.3 攝影機設定

3.3.1 攝影機設定

重新命名攝影機裝置和變更裝置名稱在螢幕顯示位置於左上 / 右上 / 左下 / 右下。

3.3.2 影像設定

在不同影像格式下變更影像相關設定

- 畫質與畫面清晰度相關。
- FPS 表示影像的流暢度。FPS 的值越大，影像呈現越順暢。
- Max Bit Rate 表示在選定的影像格式和像素內，資料所能傳輸的最大限度。

下圖以 200 萬畫素型號為例，130 萬畫素和 D1 畫素機種，則以實際介面為主。

註：QQVGA 為手機監控專用格式。

解析度	品質	FPS	最大 Bit 速率
HD1080P	高	30	8000
/ HD720P	高	30	8000
VGA	高	30	3000
QVGA	高	30	3000
QQVGA	高	30	3000

解析度	品質	FPS	最大 Bit 速率
HD1080P	高	15	8000
/ HD720P	高	30	8000
VGA	高	30	3000
QVGA	高	30	3000
QQVGA	高	30	3000

解析度	品質	FPS
HD1080P	高	30
/ HD720P	高	30
VGA	高	30
QVGA	高	30
QQVGA	高	30

3.3.3 顏色設定

調整色彩效能：亮度、對比度、色度和飽和度。按住滑桿做調整即可預覽色彩變更。

若要回復預設值，請按 [回到預設值]。

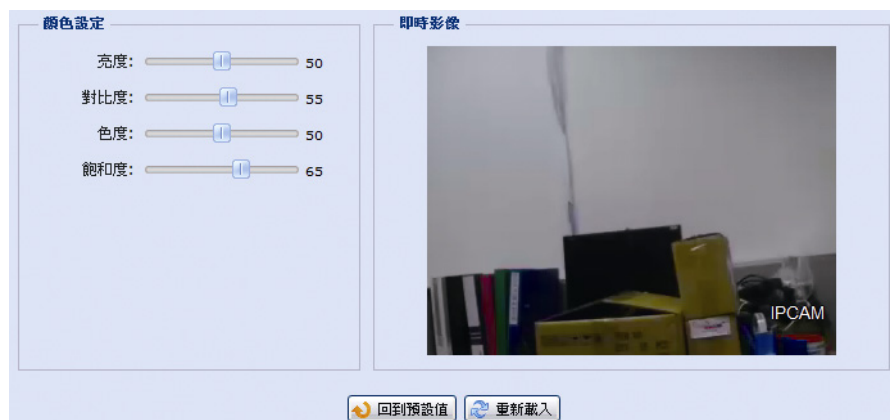

3.3.4 聲音設定

拖曳滑桿來調整麥克風和喇叭的音量。



3.3.5 進階設定

視需求調整攝影機相關參數。

百萬畫素型號



D1 畫素型號



項目	說明
快門速率*	依您的需求設定快門速率。 選項有：1/10、1/30、1/15、1/6、1 和 2 秒。
背光**	此功能是用來調整光線過曝的畫面，讓影像不會因為過曝而造成特定區域看不清楚。 請選擇 [開啓] 或 [關閉] 決定是否要啟動背光補償功能。 註： 此功能僅適用於日間模式。
鏡射	依您需求的架設環境，點選此功能後，畫面將水平旋轉。
翻轉	依您需求的架設環境，點選此功能後，畫面將旋轉 180 度。
消除雜音*	依您需求的架設環境，按住並拖曳滑桿來選取在黑暗環境下的適當參數。等級從 0 ~ 10，級數越高，雜音越少。
紅外線控制	點選 [自動] 用來開啓紅外線 LED 在遇夜間或黑暗環境時自動啟動。選擇 [開啓] 或 [關閉] 啟動紅外線 LED 功能。
白平衡*	白平衡的設定是為表現出當時的色溫，並且讓原本白色的東西，在不同色溫下仍看到白色。 選項有：自動、白燈、冷光、日光、陰天及遮陽。
清晰度	藉由調整相機光圈大小及影像邊緣銳利化，可以讓影像的小細節看起來更清楚。 按住並拖曳滑桿來選取適當參數。等級從 0 ~ 100，級數越高，影像越清晰。

* 僅支援百萬畫素型號

**僅支援 D1 畫素型號

3.4 定時錄影

3.4.1 錄影

在 [定時錄影設定] 下：

- 啟動或停用所有錄影功能。將 [啟動] 設成 [否] 時，就會停用所有的錄影功能。
- 選擇是否要在儲存裝置容量滿時覆蓋之前的檔案繼續錄下去。
- 啟動或停用錄影收音功能。
- 選擇錄影影像解析度。

註：選擇越高的解析度，影片的畫質就會越好，但記憶體就會消耗的越快。



3.4.2 定時錄影

若要設定警報，請選擇啟動錄影的日期與時間。

註：警報功能請務必選擇開啓以使錄影功能正常進行。

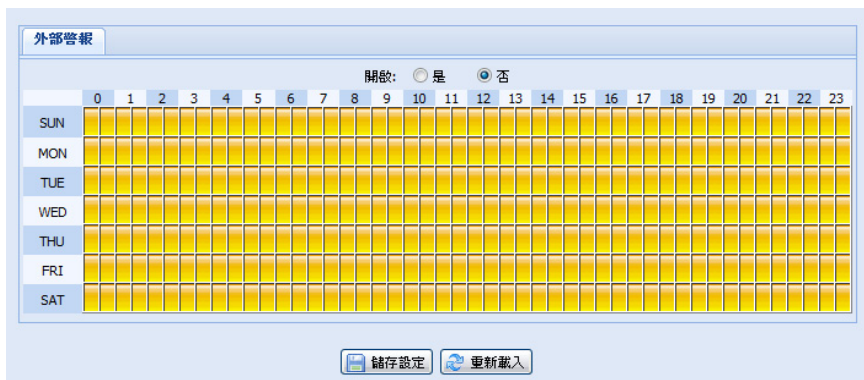

3.5 儲存裝置

3.5.1 記憶體

在 [記憶體]，您可以查看可錄影的剩餘容量，還可選擇清除所有儲存在記憶體中的錄影資料。

註：已記錄的資料將會在您按重設鍵後及重新開啓攝影機時被移除。

此攝影機最多可以儲存三筆警報錄影事件。

註：若想要儲存更多錄影資料，建議可搭配相同的 NVR 使用。

註：欲知不同錄影解析度下能錄製的總預計時間，請參閱第 30 頁「附錄 6 錄影時間表」。

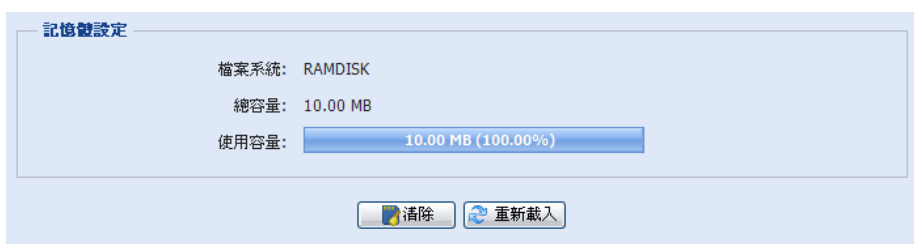

3.6 觸發設定

3.6.1 觸發設定

設定在發生警報或位移偵測後，攝影機的后續回應動作。

◆ 偵測

項目	說明
警報	視您連接的警報裝置而定，選擇 [N.O.] 或 [N.C.]。
移動	<p>開啓或關閉位移偵測功能。</p> <p>若將影像格式設為 [Motion JPEG]，就無法使用位移偵測功能。</p> <p>選取 [開啓] 後，按 [移動偵測] 進入移動偵測區域頁面如下：</p> <p>靈敏度： 設定偵測靈敏度，從 1 到 10。</p> <p>區域設定： 使用電腦滑鼠設定移動偵測區域。粉紅色格子代表未被偵測的區域，而透明的格子代表有偵測的區域。您可以設定多個偵測區域。 按 [全部清除] 清除先前選擇的偵測區域，變成全部不偵測。 按 [全部選擇] 選取全區域進行偵測。</p>
警報持續時間	設定觸發時的錄影時間 (5 / 10 / 20 / 40 秒)。

◆ 動作

設定攝影機在發生事件時傳送通知給您的方式。

項目	說明
E-Mail	先選取要收到 E-Mail 通知的事件類型。 接著，按 [E-Mail] 字樣設定媒體類型 (H.264 / JPEG / MPEG4)，檔案格式 (AVC / AVI) 及事件錄影時間 (1 到 5 秒)。 當發生選取事件時，攝影機就會將錄好的影片傳送給在 [網路設定] → [郵件管理] 內指定的收件人。
FTP	先選取要收到 FTP 通知的事件類型。 接著，按 [FTP] 字樣設定媒體類型 (H.264 / JPEG / MPEG4)，檔案格式 (AVC / AVI) 及事件錄影時間 (1 到 5 秒)。 當發生選取事件時，攝影機就會將錄好的影片上傳到在 [網路設定] → [影像上傳] 內指定的位置。
簡訊通知	選取要啟動簡訊通知的事件類型。當發生選取事件時，攝影機就會傳送簡訊到您在 [網路設定] → [簡訊通知] 內所設定的電話號碼。
警報發出	先選取要觸發警報裝置的事件類型。 接著，按 [警報發出] 字樣設定觸發規則。(低 / 高)
錄影	選取要啟動事件錄影的事件類型。
聲音警報	選取要啟動聲音警報的事件類型。

3.7 常用設定

3.7.1 常用設定

在 [常用設定] 裡，您可以選擇介面語言並查看攝影機的 MAC 位址。

若要讓 LED 狀態指示燈如第 2 頁的「1.6 狀態指示燈」所述顯示各個狀態，請在 [狀態 LED 使用模式] 選擇開啓；若要隱藏狀態，請選擇 [關閉]；若只要顯示錯誤狀態，請選擇 [暫時關閉]。

註：若重新啟動攝影機，狀態 LED 模式就會從[暫時關閉]回復為 [開啓]。

若要在閒置一段時間後鎖住攝影機登入，請在 [自動鎖定時間] 選擇 [5 分鐘]、[15 分鐘] 或 [30 分鐘]，或選擇 [從不鎖定] 關閉此功能。

註：要從攝影機鎖定的狀態下回復，請輸入登入時使用的密碼。

一般設定

一般設定

語言: 繁體中文

狀態LED使用模式: 開啟

自動鎖定時間: 15 分鐘

MAC 位址: 00:0E:53:E7:07:53

儲存設定 重新載入

3.7.2 時間設定

設定日光節約時間和目前的時間，然後按 [儲存] 確認。

時間設定

OSD: 開啓 關閉

日期: 2011/12/09

時間: 23 : 22 : 44

[儲存設定] [重新載入]

日光節約時間

日光節約時間設定

日光節約時間: 開啓 關閉

開始時間: 八月 第一週 星期一 6 : 0 (HH:MM)

結束時間: 十月 第五週 星期一 10 : 0 (HH:MM)

調整時間: 1 : 0 (HH:MM)

[儲存設定] [重新載入]

功能	說明
■ 時間設定	
日期	設定今天的日期。
時間	設定現在的時間。
■ 日光節約時間設定	
日光節約時間	選擇是否要使用日光節約功能 (開啓 / 關閉)。
	若啓動了此功能，請設定 [開始時間] 和 [結束時間]，並調整日光節約時間，以小時為單位。

3.7.3 系統日誌

若要依事件類型來快速搜尋想要的系統日誌，按 [上一頁] 或 [下一頁]，或者勾選想要搜尋的事件類型，然後按 [重新查詢]。

若要清除所有系統日誌，請按 [清除全部日誌]。

系統日誌清單

編號	事件	時間	結果
1	遠端登入	2011/12/09 23:14:49	admin
2	遠端登入	2011/12/09 23:14:02	admin
3	遠端登入	2011/12/09 23:01:07	admin
4	遠端登入	2011/12/09 22:55:31	admin
5	遠端登入	2011/12/09 22:33:25	admin
6	遠端登入	2011/12/09 22:27:37	guest
7	遠端登入	2011/12/09 21:34:55	guest
8	遠端登入	2011/12/09 21:29:16	guest
9	遠端登入	2011/12/09 21:23:52	guest
10	遠端登入	2011/12/09 21:14:09	guest
11	遠端登入	2011/12/09 21:05:47	guest
12	遠端登入	2011/12/09 20:55:36	guest
13	遠端登入	2011/12/09 20:47:26	guest
14	遠端登入	2011/12/09 20:41:30	guest
15	遠端登入	2011/12/09 20:36:21	guest
16	遠端登入	2011/12/09 20:19:32	guest

← 上一頁 | 下一頁 → | 重新查詢 | 清除全部日誌

3.7.4 連線使用者

您可以查看目前連線到此攝影機的使用者與其連線資訊。若要重新整理清單，請按 [重新查詢]。

- ▶ 若要允許匿名登入，請在 [影像匿名登入] 選擇 [開啓]。
- ▶ 若不要在登入時輸入影像驗證碼，請在 [Login with CAPTCHA Image] 選擇 [否]。

帳號	IP位址	權限	媒體類型
admin	61.63.7.65	系統管理者	H264
admin	61.63.7.65	系統管理者	H264

3.7.5 權限管理

您可以新增擁有不同使用者權限的帳號，或者刪除或修改現有帳號設定。

如何新增帳號

步驟 1：按 [New] (新增)，然後輸入以下欄位。

帳號	權限	登入時間
admin		
guest		

欄位	說明
帳號	設定要用來登入攝影機的帳號。帳號最多只允許 16 個由字母和數字組成的字元。
密碼	設定要用來進行遠端登入的密碼。密碼最多只允許 16 個由字母和數字組成的字元。
確認密碼	再輸入一次密碼確認。
權限	設定帳號的安全權限，以允許控制不同的功能。使用者權限共有四種：「系統使用者」、「超級使用者」、「一般使用者」和「訪客」。
登入時間	選擇此帳號可停留線上的時間：1 分鐘 / 5 分鐘 / 10 分鐘 / 1 小時 / 1 天 / 永久

步驟 2：接著，按一下 [儲存設定] 來儲存與完成帳號的建立。

如何修改或刪除現有帳號

步驟 1：選取想要修改或刪除的帳號。

步驟 2：若要修改帳號，請選擇 [修改] 變更設定，然後再按 [儲存設定]。若要刪除帳號，請按 [刪除]。

註：若帳號清單中只有一個帳號，則無法刪除該帳號。

3.7.6 Google 地圖

此功能用於查看目前攝影機所在位置。

如登入失敗，系統會要求您申請一組 Google 地圖金鑰，請依下方指示：

步驟 1：點選 [申請 Google 地圖金鑰]，進入申請頁面。

步驟 2：確認申請條款及細則並輸入網路攝影機之 IP 位址，然後按下 [產生 API 金鑰] 按鈕。

步驟 3：複製 API 金鑰並回到系統瀏覽頁面中按下 [修改 Google 地圖金鑰] 按鈕並貼上內容。



3.7.7 系統維護

韌體更新

此功能可用來升級與更新攝影機功能。

註：在使用此功能之外，請確認已從安裝商或經銷商處取得升級檔案。

註：更新韌體將自動移除原先儲存於攝影機的事件影片。欲進行更新韌體前，請確認重要影像已經備份到您的電腦。

步驟 1：按 [🔍] 搜尋儲存更新檔的位置，然後選擇其中一個。(至多可選四個)



步驟 2：按 [開始更新] 即可開始系統升級。

註：建議保留目前的設定，否則更新後，所有設定都將回復到預設值

註：升級需要一些時間，請勿在這期間中斷電源，否則升級可能會失敗。升級完成後，攝影機將重新啟動。

系統組態備份

此功能是您將您的系統設定複製到 System.bin 的檔案裡。

您可以匯入相同的系統設定到另一台攝影機 (舉例：AVN801)，當 AVN801 重新被設為預設值時，您將可以選擇

恢復為您原先的系統設定值。

在 [韌體更新] 選項裡，選擇 **System.bin** 檔案，並點選 [開始備份] 以匯入系統設定。

系統組態備份

在更新韌體版本之前，若您要備份系統組態，請按「開始備份」以進行備份。

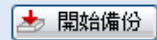

系統重新開機

若您需要重新啟動您的系統，請按下 [重新開機] 以進行系統重新啟動。

系統重新開機

若您要重新啟動您的系統，請按下「重新開機」，以進行系統重新啟動。

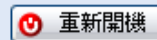

播放器下載

若您要播放下載之影像，請先下載並安裝播放器。

選擇 [免費下載] 以進行播放器下載，點選兩下即開始安裝。

播放器下載

若您要播放下載之影像，請先下載並安裝播放器。

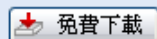

附錄 1 產品規格

機種	200 萬畫素機種	130 萬畫素機種	D1 畫素機種
■ 網路			
網路壓縮格式	H.264 / MPEG4 / MJPEG		
多重影像傳輸 (Encode 模式、IPS、解析度)	3 (H.264, MJPEG, MPEG4)		
LAN 埠	支援		
LAN 速度	10/100 Based-T Ethernet		
支援的協定	DDNS, PPPoE, DHCP, NTP, SNTP, TCP/IP, ICMP, SMTP, FTP, HTTP, RTP, RTSP, RTCP, IPv4, Bonjour, UPnP, DNS, UDP, IGMP, QoS		
Frame 速率	30 張		
線上使用者人數	10		
安全性設定	1. 多種使用者存取權限與密碼設定 2. 過濾 IP 位址 3. 摘要鑑別		
遠端監控	1. 在 Windows 作業系統使用 Internet Explorer 2. iPhone、iPad 和 Android 行動裝置使用 EagleEyes 監控軟體		
ONVIF 相容性	支援		
■ 攝影機			
影像感測器	1/2.9" SONY 影像感測器	1/4" SONY 影像感測器	1/3" 影像感測器
影像解析度	HD1080P / HD720P / VGA / QVGA / QQVGA***	SXGA / HD720P / VGA / QVGA	D1 / CIF
最低照度	0.1 Lux / F1.5, 0 Lux (紅外線 LED 開啓)		
快門速度	--	1 / 60 (1/50) 到 1 / 100,000 秒	
信噪比	超過 48dB (AGC 關閉)		
鏡頭	f3.8mm / F1.5		
視角	83.2°	62.7°	80.4°
紅外線 LED	12 顆 (10 米)		
紅外線切換	是		
白平衡	ATW		
AGC	Auto		
IRIS 模式	AES		
外接警報 I/O 埠	是		
POE	是 (IEEE 802.3af)		否
麥克風	是		
喇叭	是		
電源 (±10%)	12V / 1A	12V / 1A	5V / 1A
操作溫度	0°C ~ 40°C		
■ 其他			
行動監控	iPad, iPhone & Android		
聲音偵測	是		
RTC (網路對時)	是		
移動偵測	是		
數位 PTZ	是		否
事件通知方式	影像上傳 / 郵件傳送 / 簡訊通知		
網路瀏覽最低設備需求	<ul style="list-style-type: none"> • Pentium 4 CPU 1.3 GHz 或更高等級，或同級 AMD • 256 MB RAM • AGP 圖形顯示卡、Direct Draw、32MB RAM • Windows 7、Vista & XP，DirectX 9.0 或更新版本 • Internet Explorer 7.x 或更新版本 		

* 規格變動以實際產品為準，將不另行通知。

** 尺寸誤差範圍：± 5mm

*** QQVGA 僅提供行動監控

附錄 2 傳輸速度參照表

以下資料僅供參考用。

下表所列的傳輸速度會因您實際選取的影像大小、影像品質和影像張數，以及監控畫面複雜度和物體移動頻繁度而有所差異。

➤ 百萬畫素型號

測試環境

- 地點：辦公室入口
- 網路傳輸格式：H.264
- 攝影機類型：百萬畫素網路攝影機

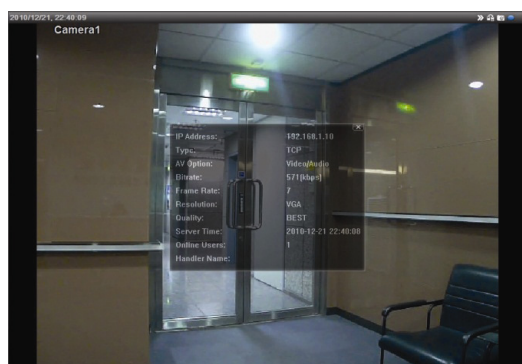

靜態畫面：無人出入



動態畫面：僅有一、兩人出入 (不頻繁)

影像規格	影像品質	Frame 速率	(動態畫面) kbps	(靜態畫面) kbps	
SXGA	最好	FULL	3253	3216	
	高		2375	2160	
	一般		1571	1266	
	基本		1465	873	
VGA	最好		2010	1261	
	高		1042	1034	
	一般		685	572	
	基本		457	350	
QVGA	最好		646	366	
	高		482	350	
	一般		302	286	
	基本		168	161	
SXGA	最好		1/4	1163	1076
	高			989	715
	一般			855	534
	基本			719	443
VGA	最好	789		571	
	高	451		447	
	一般	349		237	
	基本	217		165	
QVGA	最好	269		147	
	高	182		131	
	一般	164		113	
	基本	97		71	

影像規格	影像品質	Frame 速率	(動態畫面) kbps	(靜態畫面) kbps
SXGA	最好	1/15	581	374
	高		405	342
	一般		487	248
	基本		337	141
VGA	最好		358	79
	高		201	63
	一般		180	28
	基本		92	15
QVGA	最好		111	84
	高		99	68
	一般		97	54
	基本		58	42

➤ **D1 畫素型號**

測試環境

- 地點：辦公室入口
- 網路傳輸格式：H.264



靜態畫面：無人出入

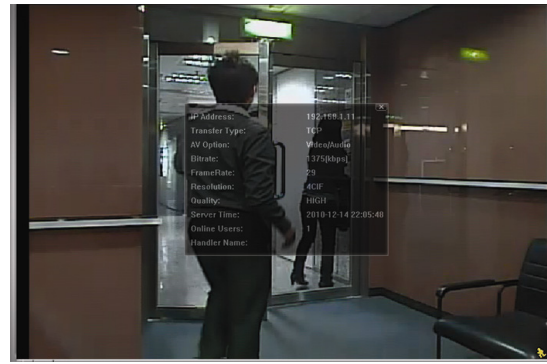

動態畫面：僅有一、兩人出入 (不頻繁)

影像規格	影像品質	Frame 速率	(動態畫面) kbps	(靜態畫面) kbps
D1	最好	FULL	2786	1546
	高		1375	705
	一般		1234	425
	基本		441	245
CIF	最好		955	290
	高		364	171
	一般		328	111
	基本		161	68
D1	最好	1/5	935	474
	高		506	272
	一般		297	175
	基本		223	108
CIF	最好		222	109
	高		133	67
	一般		81	49
	基本		71	32
D1	最好	1/30	127	70
	高		197	20
	一般		61	11
	基本		50	4
CIF	最好		42	7
	高		38	2
	一般		22	1
	基本		28	0

附錄 3 連接 POE 功能 (僅支援百萬畫素型號)

此裝置支援符合 IEEE802.3af 標準規範的 Power-over-Ethernet (POE) 功能。透過同一條網路線，即可傳送電源，不需再另外接電源線，下圖所示為兩種不同 POE 使用狀況，提供參考：

- 若您的 router 或 hub 支援 POE 功能

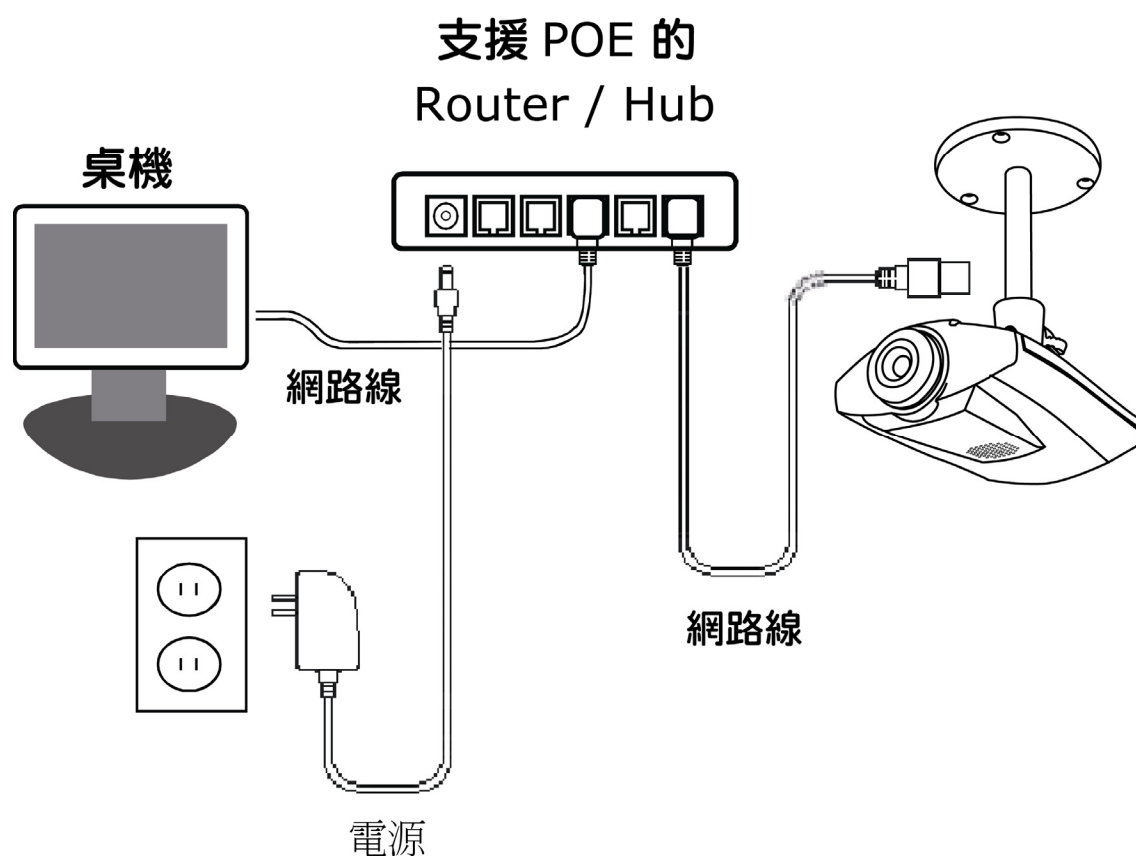

- 若您的 router 或 hub 不支援 POE 功能 (須加裝 POE 接頭)

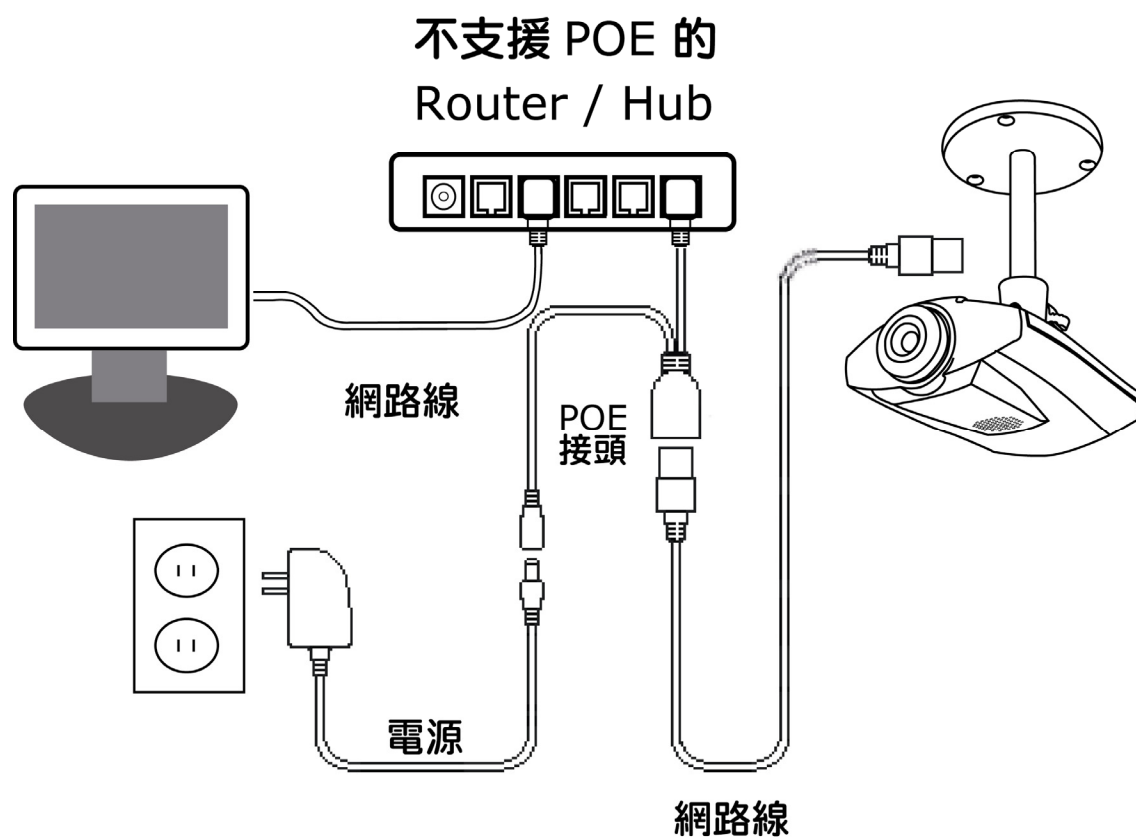

附錄 4 如何申請簡訊通知功能的應用程式介面識別碼

欲開啓攝影機的簡訊通知功能，在一事件發生的當下自動發送簡訊到手機，您必須先向 Clickatell 行動簡訊公司，申請應用程式介面識別碼。

註：簡訊通知功能並非免費提供，簡訊通知功能的費用自第十一封簡訊起算。

請依下列指示完成申請步驟。

步驟 1：登入網頁 <http://www.clickatell.com/login.php>，在 New Customers 頁面裡的下拉式選單，點選 [Clickatell Central (API)]。

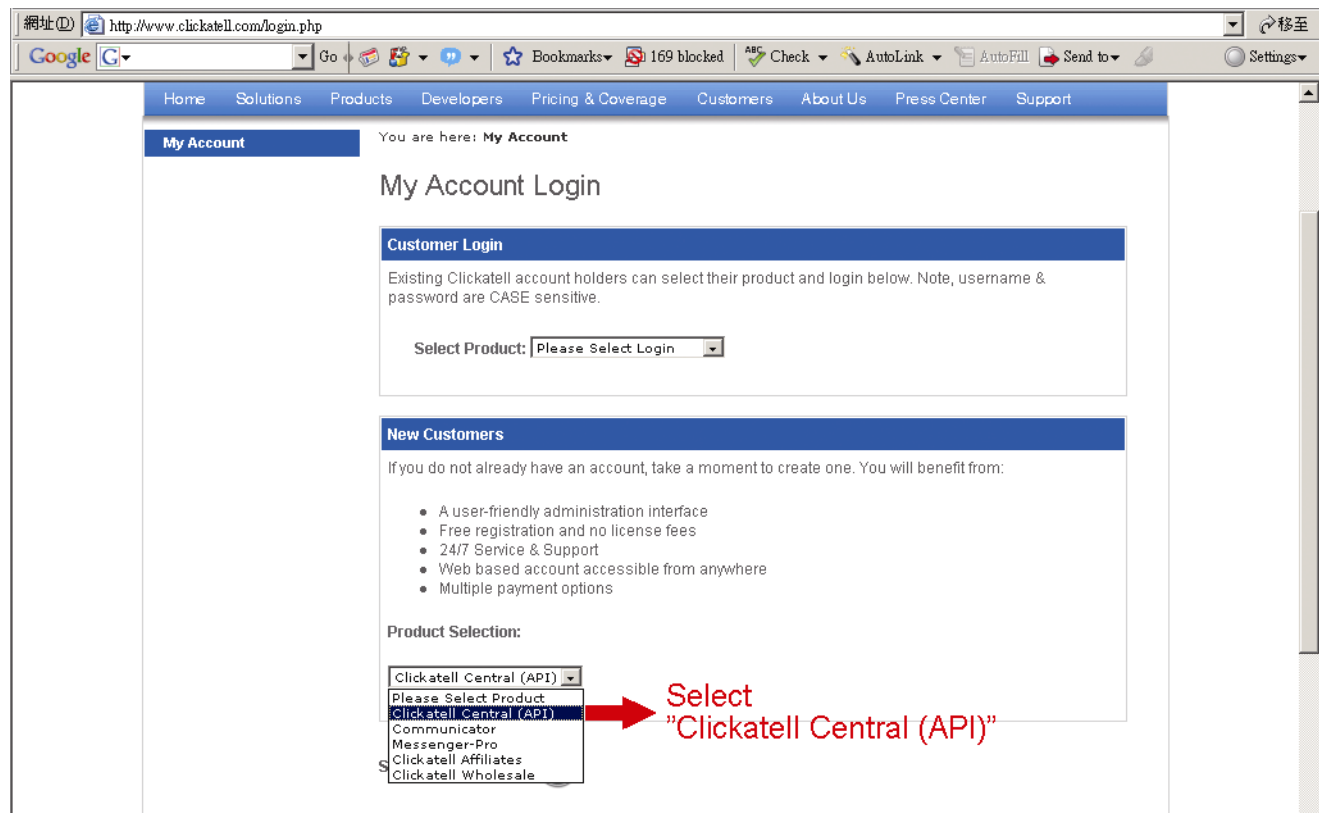

步驟 2：填入您的資料以建立一個新帳號，再點選 [CONTINUE]。

註：請記下使用者名稱、密碼和您所指定的行動電話號碼，之後用來接收簡訊通知。

步驟 3：當帳號建立成功，系統會自動發信到您所指定的電子信箱，並要求您開通該帳號。點選信件中的連結進入如下圖所示的登入頁面，輸入密碼之後，點選 [Login] 以完成開通帳號的手續。

My Account Login

Customer Login

Existing Clickatell account holders can select their product and login below. Note, username & password are CASE sensitive.

Select Product:

Username:

ClientID:

Password:

[Lost password?](#)

Enter the password you set to log in.

步驟 4：輸入您欲接收簡訊通知的行動電話號碼（包含國碼），然後點選 [SEND ACTIVATION CODE]。系統會傳送開通帳號的驗證碼到您輸入的號碼，請確認是否接收到 Clickatell 傳來的簡訊通知。

Verify your Mobile Number

For security reasons you are required to enter your mobile phone number to receive non-test SMS messages.

Your activation code will be sent to

If this is not your number, please retype your mobile number in the box above and click the "Send Activation Code" button.

Enter your activation code here:

Enter your mobile phone number, including your country code.

步驟 5：返回 Clickatell 頁面，點選 [Manage my Products] 的按鍵。然後，在從 [My Connections] 的下拉式選單裡，點選 [HTTP]。

Central Home My Settings **Manage my Products** Billing Message Reports Help

Manage my Products

Test Message in Message Box

Buy SMS Credits

My Connections: **My Connections**

Add Connection

Add Connection

HTTP

Select "HTTP".

步驟 6：在 In [Add HTTP API] 頁面輸入使用者名稱，確認 dial prefix 是否正確且 callback type 為 [HTTP GET]，確認無誤後，點選 [Submit]。

Add HTTP API - Bold Items Required

Name:

IP Lock Down:

Dial Prefix:

Callback Type:

Callback Url:

Callback Username:

Callback Password:

Minimum information required

步驟 7：取得應用程式介面識別碼，如下圖所示。

註：請記下應用程式介面識別碼，後續設定簡訊通知功能時會用到。

My Connections:

Add Connection Show All Connection Types

Name	Type	API ID	Dialing Code
IP_SMS	SMTP API	3218637	886 Taiwan
IP_MSG	HTTP	3220810	886 Taiwan

1 to 2 of 2

My Connections:

Add Connection Show All Connection Types

Name	Type	API ID	Dialing Code
IP_SMS	SMTP API	3218637	886 Taiwan
IP_MSG	HTTP	3220810	886 Taiwan

1 to 2 of 2

附錄 5 常見問題集

如有更多關於 EagleEyes 的問題，請上官網 www.eagleeyesctv.com/supp_QnA.aspx。

問題	解答
當我在家中或是辦公室時，我可以成功連上攝影機，即使是沒有無線網路的情況下。但是一旦離開家裡或是辦公室，我卻無法從手機（連上 3G 網路）或是桌電（連上網路）進入攝影機，為什麼？	您尚未成功連上網際網路，您連上的網路為區域網路。所以，請依說明書的指示完成網路設定，說明書下載請至下方連結： www.surveillance-download.com/user/m317a.swf ；或是建議您與當地安裝商或當地供應商聯繫，協助安裝事宜。因為網路設定對於初次設定的人而言，難度較高。
影像看起來很不流暢。為什麼？	影像的流暢度會受到區域網路上傳頻寬、Router 的硬體效能、攝影機下載頻寬和畫面複雜度等因素有關。（建議設定）如需看到非常流暢的影像，解析度請選取 [QVGA]；如需看到最好的畫質呈現，解析度請選取 [SXVGA] 或 [HD1080P]；如對影像流暢度和畫面沒有特殊要求，建議解析度則選取 [VGA]。
影像看起來有點模糊。為什麼？	攝影機的鏡頭焦距，請調整鏡頭來改善影像畫面。
即時的影像畫面一直閃爍。為什麼？	您必須調整攝影機的電源頻率切換至 [60 Hz] 或 [50 Hz]。 iPhone 使用者，進入攝影機畫面，選擇即時畫面右上角的  進入 IPCAM 設定頁面，然後選擇 [進階設定] → [攝影機]，以變更設定。 Internet Explorer 瀏覽器使用者，登入攝影機後選擇 [系統設定] → [攝影機設定] → [影像設定]。

附錄 6 錄影時間表

下表列出在各個錄影解析度下能錄製的總預計時間。

每種解析度測出的錄影時間，是在以下兩種警報觸發情況時所得出的平均值，僅供參考。

錄影時間會因您選擇的錄影解析度、影像品質和影錄張數、監視畫面複雜度，以及監視畫面出現移動物體的頻繁度，而有所不同。

測試環境

- 地點：辦公室
- 監控區域：離攝影機 1.5 公尺遠的位置
- 警報觸發情境：
 - (1) 一個人經過監控區域，然後馬上離開。
 - (2) 兩個人經過監控區域，一個人馬上離開，另一個人停留一會兒才離開。

錄影解析度	SXGA	VGA	QVGA
錄影時間 (秒)	25	115	211