

**SAMSUNG TECHWIN**

# **Smart Dome Camera**

## **User Manual**

SCP-2250H



**SAMSUNG**

**SAMSUNG**



## CAUTION

RISK OF ELECTRIC SHOCK.  
DO NOT OPEN



**CAUTION:** TO REDUCE THE RISK OF ELECTRIC SHOCK, DO NOT REMOVE COVER (OR BACK) NO USER SERVICEABLE PARTS INSIDE. REFER SERVICING TO QUALIFIED SERVICE PERSONNEL.



This symbol indicates that dangerous voltage consisting a risk of electric shock is present within this unit.



This symbol indicates that there are important operating and maintenance instructions in the literature accompanying this unit.

## WARNING

- To reduce the risk of fire or electric shock, do not expose this appliance to rain or moisture.
- To prevent injury, this apparatus must be securely attached to the floor/wall in accordance with the installation instructions.
- Use only the 24V, 60Hz AC adaptor for power supply.

## WARNING

1. Be sure to use only the standard adapter that is specified in the specification sheet. Using any other adapter could cause fire, electrical shock, or damage to the product.
2. Incorrectly connecting the power supply or replacing battery may cause explosion, fire, electric shock, or damage to the product.
3. Do not connect multiple cameras to a single adapter. Exceeding the capacity may cause abnormal heat generation or fire.
4. Securely plug the power cord into the power receptacle. Insecure connection may cause fire.

5. When installing the camera, fasten it securely and firmly. The fall of camera may cause personal injury.
6. Do not place conductive objects (e.g. screwdrivers, coins, metal parts, etc.) or containers filled with water on top of the camera. Doing so may cause personal injury due to fire, electric shock, or falling objects.
7. Do not install the unit in humid, dusty, or sooty locations. Doing so may cause fire or electric shock.
8. If any unusual smells or smoke come from the unit, stop using the product. In such case, immediately disconnect the power source and contact the service center. Continued use in such a condition may cause fire or electric shock.
9. If this product fails to operate normally, contact the nearest service center. Never disassemble or modify this product in any way. (SAMSUNG is not liable for problems caused by unauthorized modifications or attempted repair.)
10. When cleaning, do not spray water directly onto parts of the product. Doing so may cause fire or electric shock
11. Do not expose the product to the direct airflow from an air conditioner. Otherwise, it may cause moisture condensation inside the Clear Dome due to temperature difference between internal and external of the dome camera.
12. If you install this product in a low-temp area such as inside a cold store, you must seal up the wiring pipe with silicon, so that the external air can not flow inside the housing.  
Otherwise, external high, humid air may flow inside the housing, pooling moisture or vapor inside the product due to a difference between internal and external temperature.

## CAUTION

1. Do not drop objects on the product or apply strong blows to it. Keep away from a location subject to excessive vibration or magnetic interference.
2. Do not install in a location subject to high temperature (over 50°C), low temperature (below -10°C), or high humidity. Doing so may cause fire or electric shock.
3. If you want to relocate the already installed product, be sure to turn off the power and then move or reinstall it.
4. Remove the power plug from the outlet when there is a lightning storm. Neglecting to do so may cause fire or damage to the product.
5. Keep out of direct sunlight and heat radiation sources. It may cause fire.
6. Install it in a place with good ventilation.
7. Avoid aiming the camera directly towards extremely bright objects such as sun, as this may damage the CCD image sensor.
8. Apparatus shall not be exposed to dripping or splashing and no objects filled with liquids, such as vases, shall be placed on the apparatus.
9. The Mains plug is used as a disconnect device and shall stay readily operable at any time.
10. When using the camera outdoors, moisture may occur inside the camera due to temperature difference between indoors and outdoors. For this reason, it is recommended to install the camera indoors. For outdoor use, use the camera with built-in fan and heater.

## FCC STATEMENT

This device complies with part 15 of the FCC Rules. Operation is subject to the following two conditions :

- 1) This device may not cause harmful interference, and
- 2) This device must accept any interference received including interference that may cause undesired operation.

## CAUTION

This equipment has been tested and found to comply with the limits for a Class A digital device, pursuant to part 15 of FCC Rules. These limits are designed to provide reasonable protection against harmful interference when the equipment is operated in a commercial environment.

This equipment generates, uses, and can radiate radio frequency energy and, if not installed and used in accordance with the instruction manual, may cause harmful interference to radio communications. Operation of this equipment in a residential area is likely to cause harmful interference in which case the user will be required to correct the interference at his own expense.



### IC Compliance Notice

This Class A digital apparatus meets all requirements of the Canadian Interference.-Causing Equipment Regulations of ICES-003.

## IMPORTANT SAFETY INSTRUCTIONS

---

1. Read these instructions.
2. Keep these instructions.
3. Heed all warnings.
4. Follow all instructions.
5. Do not use this apparatus near water.
6. Clean only with dry cloth.
7. Do not block any ventilation openings. Install in accordance with the manufacturer's instructions.
8. Do not install near any heat sources such as radiators, heat registers, or other apparatus (including amplifiers) that produce heat.
9. Do not defeat the safety purpose of the polarized or grounding-type plug. A polarized plug has two blades with one wider than the other. A grounding type plug has two blades and a third grounding prong. The wide blade or the third prong is provided for your safety. If the provided plug does not fit into your outlet, consult an electrician for replacement of the obsolete outlet.
10. Protect the power cord from being walked on or pinched particularly at plugs, convenience receptacles, and the point where they exit from the apparatus.
11. Only use attachments/accessories specified by the manufacturer.
12. Use only with the cart, stand, tripod, bracket, or table specified by the manufacturer, or sold with the apparatus. When a cart is used, use caution when moving the cart/apparatus combination to avoid injury from tip-over.
13. Unplug this apparatus during lightning storms or when unused for long periods of time.
14. Refer all servicing to qualified service personnel. Servicing is required when the apparatus has been damaged in any way, such as powersupply cord or plug is damaged, liquid has been spilled or objects have fallen into the apparatus, the apparatus has been exposed to rain or moisture, does not operate normally, or has been dropped.



Apparatus shall not be exposed to dripping or splashing and no objects filled with liquids, such as vases, shall be placed on the apparatus

# CONTENTS

---

<b>OVERVIEW</b>	6	important safety instructions
	7	contents
<b>2</b>	8	Features
	8	What's Included
	9	At a Glance
<b>INSTALLATION &amp; CONNECTION</b>	10	Optional Accessories for Installation
	12	Precautions
<b>10</b>	12	Preparation
	13	Installation
	16	Initial Setup
	19	Connecting With Other Device
<b>SETUP</b>	22	How to use the keyboard controller
	23	Main Menu
<b>22</b>	24	Profile
	26	Camera Set
	35	Intelligent Video
	37	Privacy Zone
	38	Preset
	40	Auto Set
	44	Zone Set
	45	Alarm Set
	47	Clock Set
	47	Other Set
	49	Communication
	50	System Info
<b>APPENDIX</b>	51	Shortcut Keys
	52	Specifications
<b>51</b>	54	Product Appearance

## FEATURES

---

- With the state-of-the-art digital signal processing technology, full digital image processing and special algorithm of 600-line high resolution implemented
- High performance surveillance camera, equipped with x25 zoom lens and digital zoom IC, enabling monitoring up to 400 times
- DAY/NIGHT to improve the sensitivity by automatic conversion into the black and white mode at night or in the environment with low illumination
- White Balance to control the brightness to the illumination
- Backlight Compensation under spotlight or utmost bright illumination
- Auto Focus to automatically adjust the focus to the subject movement
- Privacy zone to hide a specific area for personal privacy
- PAN/TILT for precise control at high speed

## WHAT'S INCLUDED

---

Please check if your camera and accessories are all included in the product package.



Camera



Housing

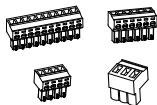

Connectors



User Manual



Grease



Pin & Bush



## CAMERA

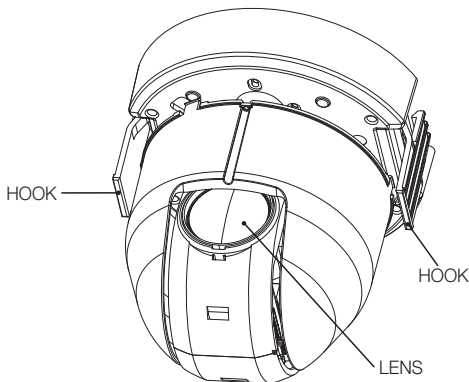

## FRAME SET

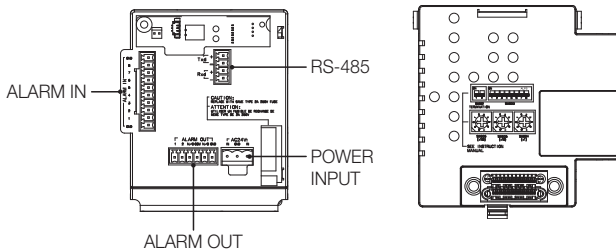

- Wipe out a dirty surface of the lens softly with a lens tissue or cloth to which you have applied ethanol.

## OPTIONAL ACCESSORIES FOR INSTALLATION

---

For your easier installation, you can purchase appropriate optional accessories available.

1. WALL MOUNT ADAPTOR (SCX-300WM)  
This is a wall mount adaptor, used for wall-mounted installation of SMART DOME CAMEA units.

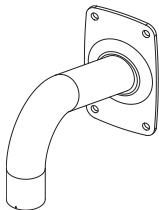

2. CEILING MOUNT ADAPTOR (SCX-300CM)  
This is a ceiling mount adaptor, used for installation of SMART DOME CAMEA units on a concrete ceiling.

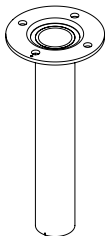

3. POLE MOUNT ADAPTOR (SCX-300PM)  
This is an adaptor for WALL MOUNT ADAPTOR (SCX-300WM) installation on a pole whose diameter is bigger than 80mm.

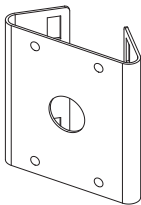

**4. CORNER MOUNT ADAPTOR (SCX-300KM)**

This is an adaptor for WALL MOUNT ADAPTOR (SCX-300WM) installation on the corner of wall joint.

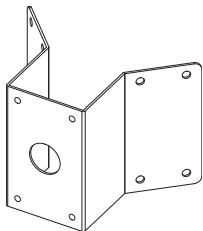

**5. PARAPET (LONG) MOUNT (SCX-300LM)**

This is a mounting kit used for installation of SMART DOME CAMEA units on a parapet.

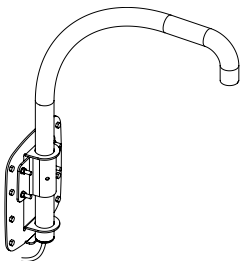

# installation & connection

---

## PRECAUTIONS

---

1. Select an installation spot which can endure more than 4 times of the product weight.
2. When installing, prevent peoples approaching to avoid personal injury.  
Move valuables to a safer place before installing.

## PREPARATION

---

Run all the external cables through the bracket adaptor's **PIPE** or **MOUNT** hole.

Wrap around the **HOUSING**'s screw hole with the Teflon Tape.

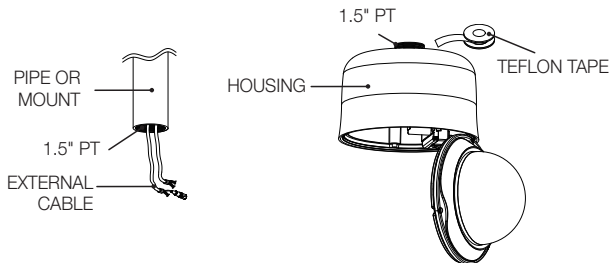

# INSTALLATION

1. Press the **SNAP FIT** of the **ADAPTOR** in the **HOUSING** to open the **ADAPTOR** part, and then insert all external cables into the **HOUSING**. Secure the **HOUSING** on the **PIPE OR MOUNT** by turning it clockwise.  
(Secure two components tightly, to avoid loosened **HOUSING**.)

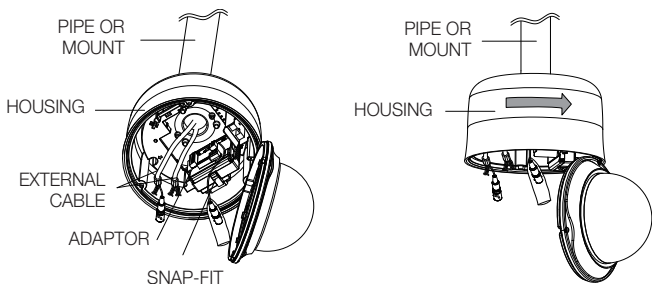

2. Connect external cables to the **CONNECTORS**(**ALARM IN**, **POWER**, **RS-485**, **ALARM OUT**) and connect the **CONNECTOR** to the **ADAPTOR**. Insert the cable into the **FRAME SET**, and close the **ADAPTOR**.

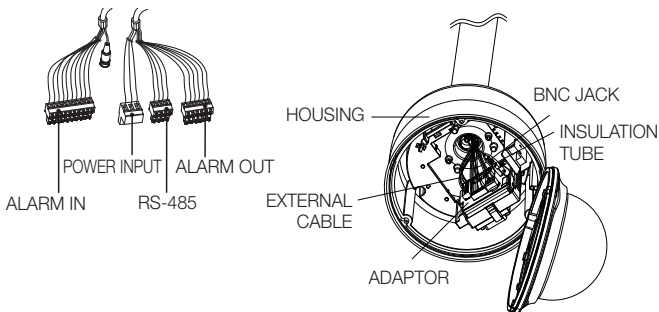

- Then, wrap the **BNC JACK** with the **INSULATION TUBE**, and use an insulation tape to seal up the end of the **INSULATION TUBE** so that the **BNC JACK** does not protrude outside of the **INSULATION TUBE** coating.  
For more information about cable connection, refer to **Connecting the adaptor cable**. (page 19)

# installation & connection

Note that **BUSHING**s are provided for outdoor installations where exposed to a moisture condition through the **PIPE** or **MOUNT**, install the **HOUSING** using the **BUSHING** to prevent moisture entering.

- Apply grease of proper dose on the **BUSHING** before assembling, and run cables through each hole of the bushings. Use **PINS** to stop up empty holes having no cable running.
- Assemble the **BUSHING** to the top side of **HOUSING**'s inside as shown in the diagram below. At the moment, apply pressure evenly on the **BUSHING** to secure it tightly to the **HOUSING** as shown in the diagram.

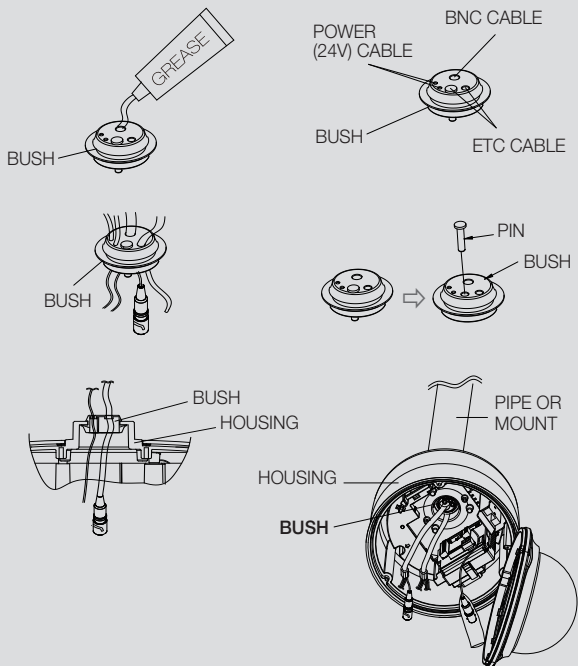

3. Tie up the **SAFETY WIRE** of the **CAMERA** on the **BRACKET WIRE** of the **FRAME SET**.

Arrange the **22P CONNECTOR** of the **CAMERA** in line with that of the **ADAPTOR**, push the **HOOKS** on either end of the **CAMERA** in the **RACK** direction of the **FRAME SET** to secure the two.

Then, ensure that all of the two **HOOKS** clicks to fix to the **RACK** properly.

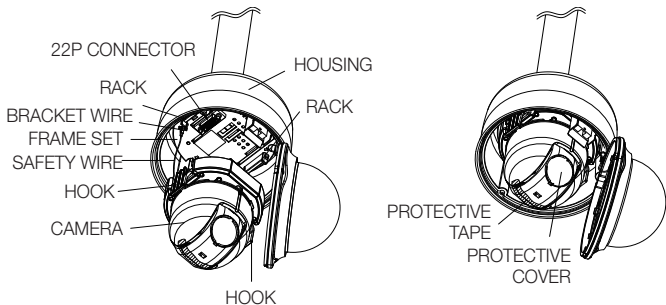

- When the installation is completed, remove the **PROTECTIVE COVER** and **PRETOECTIVE TAPE** from the lens.

4. Align each of the 3 **SCREWS** of **COVER DOME** and 3 **SCREW HOLES** of the **HOUSING** respectively, and assemble the **COVER DOME** and **HOUSING**. During the assembling, note on the followings.

- Insert and arrange **SAFETY WIRE** into the **HOUSING** while not disturbing the camera operation.
- Ensure that the **GASKET DOME** component does not separate from the **COVER DOME**. (If the **GASKET DOME** is not properly assembled, it damages the waterproofness.)

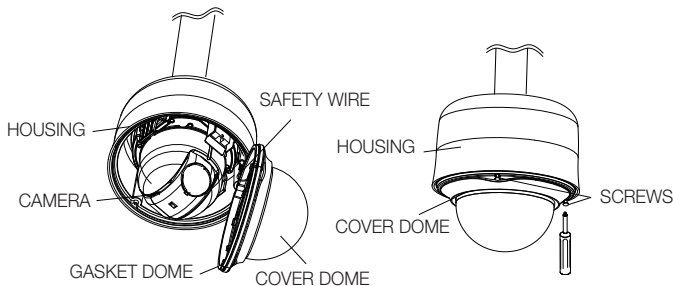

## INITIAL SETUP

### Camera Address Setup

Use SW606, SW605, and SW604 to specify the camera address.

You can specify between 0 and 255 for the address, where the hundreds digit is with SW606, the tens digit with SW605, and the ones digit with SW604.

ex) Camera address: If the address is 1, follow the steps in the figure below.

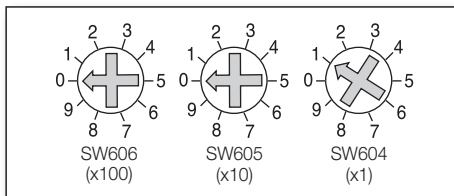

### Communication Protocol Setup

Use pins #1~#4 of SW603 to specify the communication protocol.

PIN Comp	PIN1	PIN2	PIN3	PIN4	PIN7
A	OFF	OFF	OFF	OFF	OFF
B	ON	OFF	OFF	OFF	OFF
C	OFF	ON	OFF	OFF	OFF
D	ON	ON	OFF	OFF	OFF
E	OFF	OFF	ON	OFF	OFF
---	ON	OFF	ON	OFF	OFF
---	OFF	ON	ON	OFF	OFF
H	ON	ON	ON	OFF	OFF
I	OFF	OFF	OFF	ON	OFF
J	ON	OFF	OFF	ON	OFF
---	OFF	ON	OFF	ON	OFF
---	ON	ON	OFF	ON	OFF
---	OFF	OFF	ON	ON	OFF
N	ON	OFF	ON	ON	OFF
O	OFF	ON	ON	ON	OFF
P	ON	ON	ON	ON	OFF
Q	OFF	OFF	OFF	OFF	ON
R	ON	OFF	OFF	OFF	ON

A : SAMSUNG HALF

B : SAMSUNG FULL

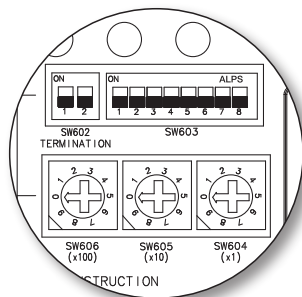

<Bottom of the camera holder>



## Baud Rate Setup

Use pins #5, #6 of SW603 to set the baud rate.

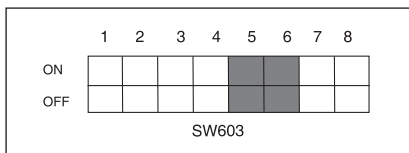

BAUD RATE	PIN 5	PIN 6
4800 BPS	ON	ON
9600 BPS	OFF	ON
19200 BPS	ON	OFF
38400 BPS	OFF	OFF

The factory default is 9600 BPS.

## Setting RS-422A/RS-485 Termination

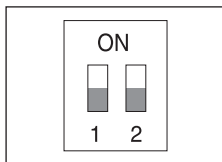

As it is shown in the structure map, when Controller and RS-422A/RS-485 is connected, it should be terminated according to the Cable feature of impedance on the each end of the transmitting line to transfer the signals in long distance by controlling the reflection of the signals to the lowest.

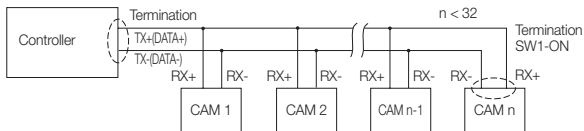

Termination : Using numbers 1 and 2 PIN, turn to <ON> and it will be terminated.

# installation & connection

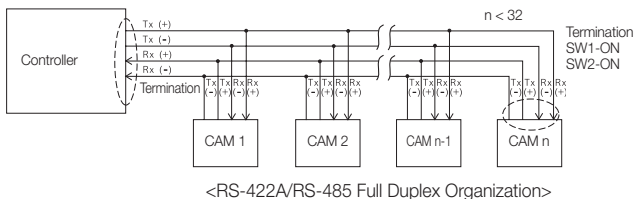

- A communication error may occur if you connect multiple cameras that are assigned the same address in the network.

## CONNECTING WITH OTHER DEVICE

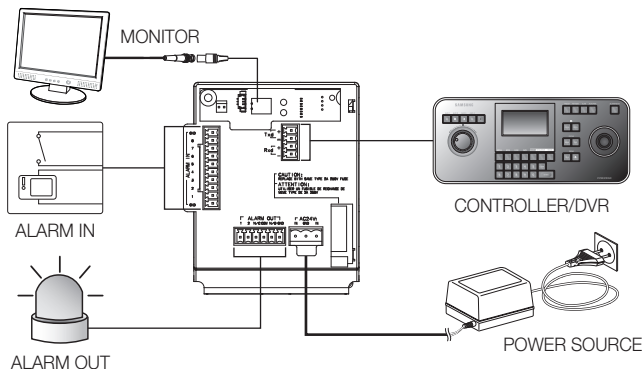

### Connecting to a monitor

1. Connect one end of the BNC video cable connector to the Video Output Terminal (VIDEO OUT).
2. Connect the other end of the connector to the Video Input Terminal of the monitor.

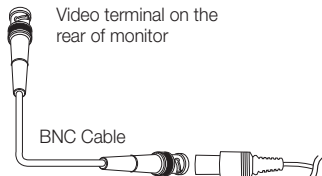
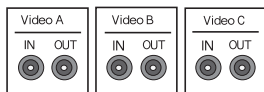

## To connect ALARM IN

1. Connect one end of the external device's signal line to a corresponding ALARM IN port of the monitor.
2. Connect the other end of the signal line to the earth-grounding [GND] port.

## To connect ALARM OUT

1. Connect one end of the external device's signal line to a corresponding ALARM OUT port of the monitor.
2. Connect the other end of the signal line to the common [COM] port.

## To connect the controller

Connect an external controller or DVR to the camera, with which you can adjust the camera.

1. Connect the Rx+ pin of the camera to the Tx+ pin of the controller.
2. Connect the Rx- pin of the camera to the Tx- pin of the controller.
3. Connect the Tx+ pin of the camera to the Rx+ pin of the controller.
4. Connect the Tx- pin of the camera to the Rx- pin of the controller.

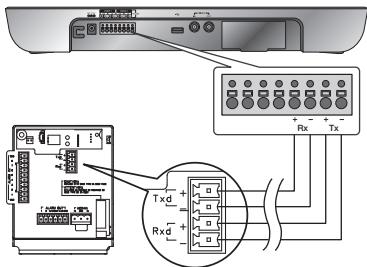

## Connecting the adaptor cable

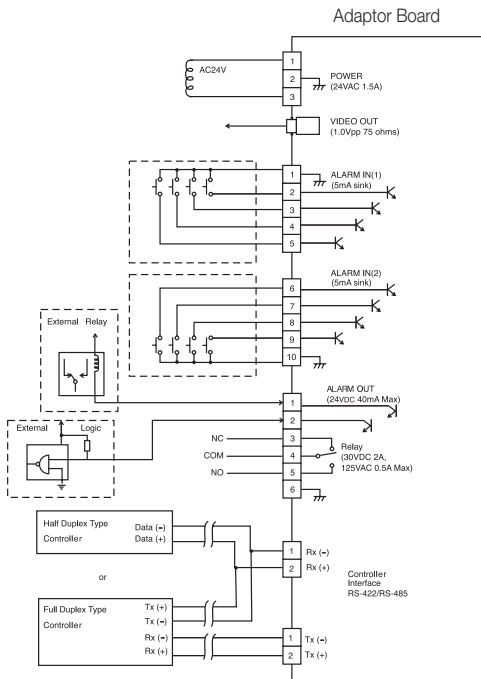

## Power Supply

Connect the cables as necessary, and turn on the camera to check if it works properly.

1. Connect the adaptor to the power terminal of the camera.
2. Plug the power cord of the adaptor into the wall outlet.

Connect the camera to the keyboard controller or DVR, with which you can manipulate and change the settings of the camera.









## HOW TO USE THE KEYBOARD CONTROLLER

---

Follow the steps below to set the camera menu using the controller.

1. Open the Camera Setup screen.
2. Use the joystick to navigate through the menus.
3. Press **[ENTER]** to select a menu item.
4. Use the joystick to change the value of the selected item.
5. Press **[ENTER]** to apply your changes.

### Using OSD icons

- : If these icons appear in the left and right corner of a menu item, you can use the joystick to move to the previous or next menu.
  -  (EXIT): Exits the menu setup screen.  
Before exiting the setup screen, select **<SAVE>** to save your settings to the whole menus, or **<QUIT>** to cancel them.
  -  (RET): Saves your settings and returns to the previous screen.
  -  (HOME): Returns to the main menu.
  -  (SAVE): Use this icon if you want to save your settings after you specified the mask area and privacy area, etc.  
Once you saved your settings, the changes remain intact even if you select **<QUIT>** on exit.
  -  (DEL): Use this icon if you want to delete a mask, or privacy area, etc.  
Once you deleted your settings, the deletions remain valid even if you select **<QUIT>** on exit.
  - : This icon appears in the right of a menu containing sub menu items.
- 
- 
    - While any operation of PRESET, AUTO PAN, SCAN, and PATTERN is running, and if the camera is turned off and back on without any particular manipulation, the camera will resume the last run operation.
    - You can set the menu item only if the tilt angle is within 90°. If you enter the menu setup screen with the camera positioned out of a tilt of 90°, the camera will rotate by 180° to fall into the opposite position within a tilt of 90°.

# MAIN MENU

This is the first screen you ever see when you turn on the camera where you can set the camera environment to your needs.

For selecting and saving each menu item, refer to "How to use the keyboard controller". (page 22)

- **PROFILE**

Select a mode appropriate to the camera installation environment.

- **CAMERA SET**

You can configure the camera settings.

- **INTELLIGENCE**

Offers motion detection and tracking functions.

- **PRIVACY ZONE**

You can configure the privacy settings.

- **PRESET**

You can set the PRESET POSITION and DURATION.

- **AUTO SET**

Contains sub menu items of AUTO PAN, PATTERN, SCAN and AUTO PLAY.

- **ZONE SET**

You can set the standard azimuth and zone area for the camera.

- **ALARM SET**

You can set the alarm priority and I/O sequence.

- **CLOCK SET**

You can set the display time and format.

- **OTHER SET**

You can set preferred language, reset the system, and select an OSD color to your preference.

- **COMMUNICATION**

Configures the settings pertaining to RS-485 communication.

- **SYSTEM INFO**

Shows the system information such as the camera version or communication settings.

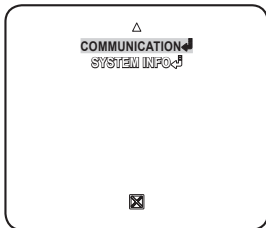
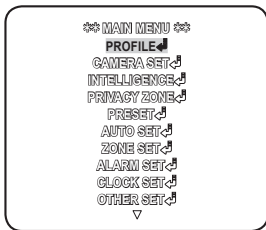

## PROFILE

You can select one from the pre-determined configurations as appropriate to your specific camera installation environment.

Your selection on each item in PROFILE will affect all other settings of the camera.

- **STANDARD**

Automatically optimizes the camera settings to the normal environment.

- **ITS**

This setting enables you to analyze the traffic situation and take the traffic information at a glance.

- **BACKLIGHT**

This setting enables you to view a sharp background and object even in a severe backlight scene.

- **DAY/NIGHT**

Automatically optimizes the camera settings to the day and night scene.

- **GAMING**

This automatically configures the settings so that you can work in a stable illumination condition as indoors.

- **CUSTOM**

Your change to any of the PROFILE settings will switch the display to CUSTOM.



CAMERA SETUP MENU		STANDARD	ITS	BACKLIGHT	DAY/NIGHT	GAMING
Parent Menu	Sub-menus					
IRIS		ALC	ALC	ALC	ALC	ALC
	ALC	-	-	-	-	-
	LEVEL	0	0	0	0	0
	BACKLIGHT	OFF	OFF	BLC	OFF	OFF
MOTION		(F.FAST) ---	(F.FAST) ---	NORM	(F.FAST) ---	SLOW
DNR		MEDIUM	MEDIUM	MEDIUM	MEDIUM	MEDIUM
SHUTTER		(OFF)---	(OFF)---	(OFF)---	(OFF)---	(OFF)---
SENSE UP		AUTO X4	AUTO X2	AUTO X4	AUTO X4	AUTO X4



CAMERA SETUP MENU		STANDARD	ITS	BACKLIGHT	DAY/NIGHT	GAMING
Parent Menu	Sub-menus					
XDR		MEDIUM	MEDIUM	MEDIUM	MEDIUM	MEDIUM
DAY/NIGHT		AUTO	AUTO	DAY	AUTO	DAY
	NIGHT	-	-	-	-	-
	BURST	OFF	ON	OFF	OFF	OFF
	EXT	-	-	-	-	-
	BURST	OFF	ON	OFF	OFF	OFF
WHITE BAL		DAY	DAY/NIGHT	DAY	DAY/NIGHT	DAY
	DAY	-	-	-	-	-
	MODE	ATW2	ATW1	ATW1	ATW1	ATW1
	RED	0	0	0	0	0
	BLUE	0	0	0	0	0
	NIGHT	-	-	-	-	-
	BRIGHTNESS	Custom Setting	MEDIUM	Custom Setting	MEDIUM	Custom Setting
	MODE	OFF	ATW2	OFF	ATW2	OFF
	RED	Custom Setting	0	Custom Setting	0	Custom Setting
	BLUE	Custom Setting	0	Custom Setting	0	Custom Setting
DETAIL		2	2	2	2	2

## CAMERA SET

You can configure the general settings of the camera module.

For selecting and saving each menu item, refer to “How to use the keyboard controller”. (page 22)

1. Select <MAIN MENU> - <CAMERA SET>. The Camera Setup menu appears.
2. Change the settings as necessary, or select an item to check.

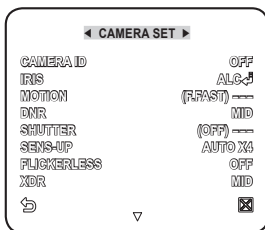

### CAMERA ID

Provide the ID and location for a camera that displays on the screen.

For selecting and saving each menu item, refer to “How to use the keyboard controller”. (page 22)

1. Select <CAMERA SET> - <CAMERA ID>.
2. Use the joystick to select a desired character, then press [ENTER]. In the lower input box of the screen, the selected character will be entered.

- You can enter up to 54 characters including alphabets, numbers and special characters.
- LOCATION : Specify the display position of the camera ID.

3. When done, press [ENTER]. The camera ID will be displayed in the specified position.

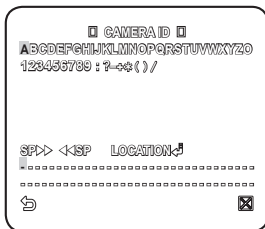

## IRIS

The IRIS menu is useful if you set to adjust the intensity of radiation incoming to the camera.

- ALC : Adjust the open and close of the iris.
  - LEVEL : Select an overall brightness level.
  - BLC : With <BACKLIGHT> set to <BLC>, you can specify the BLC area. With AREA set to <USER>, you can specify the position and size.

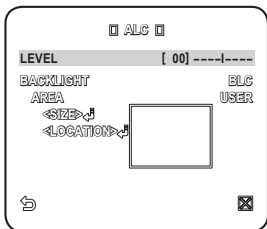

- MANUAL : Adjust the iris level manually.
  - The overall brightness target of a camera will be set to ALC level 0, while the iris can be adjusted manually.

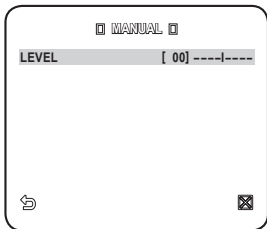

## AGC

With this, you can adjust the AGC level of a camera.

With AGC active, if the signal strength falls below the standard level, AGC will amplify the video signal to automatically improve the sensitivity.

If <SENS-UP> is set to <OFF>, or <FIX> mode, the <MOTION> menu will switch to <AGC>.

With the USER (↙) submenu selected, press [ENTER] to display the corresponding screen.

In this mode, you can select from VERY LOW to VERY HIGH in 16 levels, enabling deeper, wider choices to your convenience.

With the FIX (↘) submenu selected, press [ENTER] to display the corresponding screen. In this mode, you can select an individualized mode in 16 levels, regardless of the brightness.

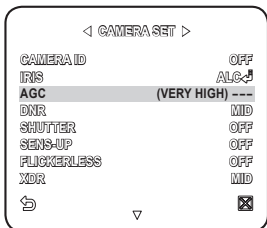



- As long as the DAY/NIGHT menu is set to AUTO in Camera Setup, the AGC menu is not available.
- As long as FLICKERLESS is set to ON, the FIX mode is not available.

## MOTION

You can specify a level of AGC for controlling the camera motion.

This is available only of the SENSE UP menu is set to AUTO.

Select F.FAST if you want to monitor a very fast moving object in a low contrast scene, and S.SLOW if monitoring a very slow moving, inanimate object in the same condition.

- As long as DAY/NIGHT is set to <AUTO>, the <MOTION> menu is not available.

## DNR

Reduces the noise on the camera image.

The higher the level is, the greater the effect is.

Set it to <USER> to specify the level.

## SHUTTER

You can select a fixed fast electronic shutter speed in 7 options ranging from 1/100 to 1/10k, which is mostly used to take a picture of a fast moving object.

- As long as SENSE UP is set to AUTO, FIXED / FLICKERLESS to ON, the SHUTTER menu is not available.

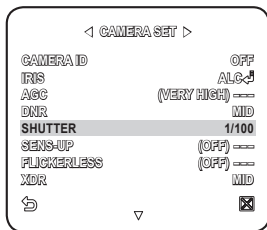

## SENS-UP

Automatically senses the darkness level at night or in a low contrast scene, and extends the accumulation time accordingly; you can select <AUTO> or <FIX> for a bright and sharp image.



- If the SHUTTER menu is set to fixed electronic shutter mode, the SENSE UP menu will not be available.
- As long as the FLICKERLESS is set to ON, you cannot set the SENS-UP FIX.

## FLICKERLESS

This will prevent possible screen distortion due to a mismatch between the vertical sync frequency and the blinking frequency of the lighting; if set to <ON>, the shutter speed will be fixed to 1/100 second.

- If SHUTTER is set to FIX, SENSE UP to FIX, and AGC to FIX, the <FLICKERLESS> menu is not available.

## XDR

This will correct a brightness difference between different scenes for the optimal visibility by calculating the ambient luminance contrast in a certain unit of pixels. The higher the value is, the higher the correction level is.

## DAY/NIGHT

You can specify a recording mode according to the scene.

For selecting and saving each menu item, refer to "How to use the keyboard controller". (page 22)

1. Select <CAMERA SET> - <DAY/NIGHT>.

2. Select a screen transition mode according to the illumination, and set options as appropriate.

- DAY : Fixed to DAY mode, regardless of the scene.
- NIGHT : Fixed to NIGHT mode, regardless of the scene.  
If BURST is set to <ON>, the burst signal will be output along with the black-and-white composite video signal.
- AUTO : According to the luminance, this will switch DAY to NIGHT mode, or vice versa.

- BURST : If set to <OFF>, the burst signal will not be output in NIGHT mode.
- DAY➡NIGHT BRIGHTNESS : Specify the brightness level switching from COLOR to BW filter.  
Adjusting from HIGH to LOW will cause to switch the filter in a darker screen.
- DAY➡NIGHT DWELL TIME : Time required to determine the filter switch.
- NIGHT➡DAY BRIGHTNESS : Specify the brightness level switching from BW to COLOR filter. Adjusting from HIGH to LOW will cause to switch the filter in a darker screen.

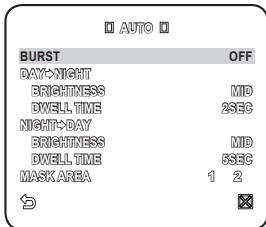
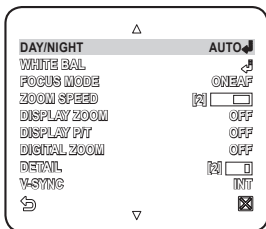

- NIGHT → DAY DWELL TIME : Time required to determine the filter switch.

- MASK AREA : If there exists a bright spot light source in a night scene, you can specify the size and position as needed.

This will prevent an error in switching filter, or failure to determine the filter switch in a night scene where a bright spot light source exists.

Any excessively bright area in a night scene will be MASKed.

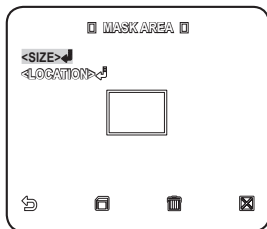

■ You can specify MASK 1 and 2 simultaneously.

■ If <BACKLIGHT> is set to <BLC>, the MASK AREA function is not available.

● EXT : The interface to an external alarm enables an automatic switch between DAY and NIGHT mode.

If you set <DAY/NIGHT> to EXT, and alarm #1 to NO/NC in ALARM SET-ALARM IN SET, the alarm can be used for an input signal in EXT mode of <DAY/NIGHT>.

If an alarm signal occurs, the mode will switch to NIGHT.



■ If <DAY/NIGHT> is set to EXT, ALARM1 in ALARM OUT SET, and ALARM1 in ALARM SET-AUTO SET are not available.

■ If you use an infrared light source while in AUTO mode, this may cause a failure in AUTO SWITCH or AUTO FOCUS.

## WHITE BAL

If you need to adjust the color according to the ambient illumination, you can use the <WHITE BAL> function.

For selecting and saving each menu item, refer to "How to use the keyboard controller". (page 22)

Illumination is generally referred to as color temperature, which is represented in a measurement of kelvin (K). Color temperatures for ordinary lighting are as follows:

In the <WHITE BAL> menu, you can set a mode for correcting the <WHITE BAL>.

- ATW1,2 : If you set the <WHITE BAL> menu to <ATW1> or <ATW2> mode, this will monitor the change of the color temperature to correct the <WHITE BAL> as needed.

The following color temperature ranges are assured in individual modes:

ATW1 : 2500K ~ 9300K (※1)

ATW2 : 2000K ~ 10000K  
(suitable to sodium light source) (※2)

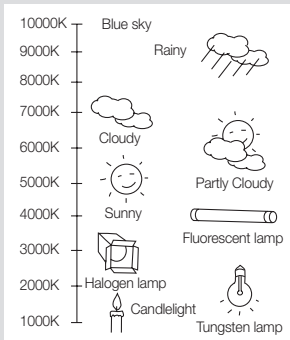

※1 : With <ATW1> mode active in a color temperature environment ranging beyond between 2500K and 9300K, a proper white balance value may not be produced; if this is the case, you are recommended to use <ATW2> mode.

※2 : With <ATW2> mode active in a mostly single color environment, the display color and the actual one may differ; so select a mode as appropriate to your color temperature environment.

1. Select <CAMERA SET> - <WHITE BAL>.
2. Select a mode where you set the <WHITE BAL>.

- DAY : You can set the RED, and BLUE value in DAY mode.  
The screen will be displayed in colors according to your settings.
- You can set the R-GAIN, and B-GAIN value only in <AWC> mode.
- If AGC is set to <OFF> or <FIX>, the NIGHT menu can not be accessed.

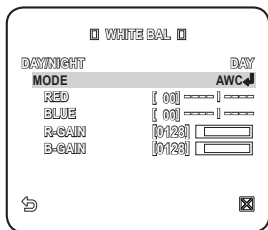

- NIGHT : You can set the <WHITE BAL> according to the ambient illumination. If NIGHT mode is set to <OFF>, the <WHITE BAL> will operate in a mode specified in DAY mode at all times; otherwise, the screen will switch to a mode specified in <DAY/NIGHT>. You can set the RED, BLUE and BRIGHTNESS value in DAY mode. The screen will be displayed in colors according to your settings.

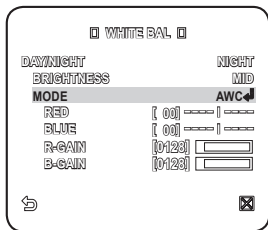

3. According to the specified recording mode, select a <WHITE BAL> mode with necessary options.
  - ATW1,2 : The camera can automatically adjust the color temperature in real time, according to the ambient conditions.  
(Color temperature range 1: 2500K ~ 9300K, 2 : 2000K ~ 10000K)
  - AWC : Pressing [ENTER] on a desired item will perform ATW once.
  - You can set the R-GAIN/B-GAIN value.
  - 3200K : Set the color temperature to 3200K.
  - 5600K : Set the color temperature to 5600K.
    - BRIGHTNESS : Specify a brightness level switching from DAY mode to NIGHT mode setting.
    - RED : Adjust the strength of the red color.
    - BLUE : Adjust the strength of the blue color.
    - R-GAIN/B-GAIN : Specify the current color temperature manually.



## FOCUS MODE

You can select a focus mode according to the angle that you adjusted for camera recording.

- AF : This will monitor the screen continuously to focus automatically. If you adjust the focus manually, that will operate the same as in <MF>. This will also restore focus after the operation of pan/tile/zoom.
- SENSITIVITY : Indicates the sensitivity of auto focus, which you can adjust between level 1 and level 7.

The closer your setting is to 7, the more sensitively the auto focus function performs. The Night setting is used when a strong light reflects in a low contrast scene. You can set it to OFF, LOW, MEDIUM, or HIGH; set it to <HIGH> when there exist a strong light such as street light.

- ONEAF : Restores focus after the operation of pan/tile/zoom, and operates the same as in <MF> unless the operation of pan/tile/zoom is executed.
- MF : You can adjust the focus manually.

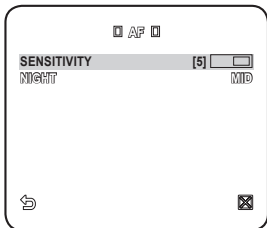
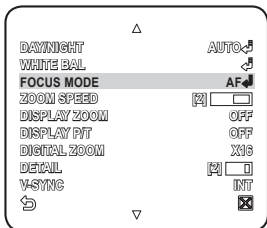

- 
  - While you are working on the following objects, <AF> may not work properly. If this is the case, use <MF> instead.
    - Very bright object, or dominant object in a dark scene
    - Object against the rear side of a moist or dirty glass
    - A scene where nearby and distant objects co-exist
    - White wall or single-colored object
    - Venetian blinds and other horizontally striped objects

## ZOOM SPEED

You can adjust the zoom operation speed.

## DISPLAY ZOOM

You can set to display the zoom status on the screen.

- It will disappear in about 3 seconds if the zoom factor has no further change.

## DISPLAY P/T

You can set to display the operation status of pan/tilt when it is active.

- It will disappear in about 3 seconds if the pan/tilt position has no further change. However, the allowable error is  $\pm 2^\circ$ .

## DIGITAL ZOOM

You can set the maximum allowable digital zoom ratio.

Digital Zoom will start operation after it is zoomed in to the maximum optical ratio of x25. If you set DIGITAL ZOOM to x16, you can take a shot at up to x400 (25x16).

## DETAIL

Used to adjust the vertical and horizontal distinction, respectively.

## V-SYNC

You can set the V-SYNC mode.

- If you select <INT>, the camera will use the internal synchronization.
- If selecting <LINE>, the camera will use an external power frequency for synchronization. The LL-PHASE can be adjusted as appropriate.

## AGC COLOR SUP

You can adjust the color reproduction range according to AGC.

## REVERSE

You can reverse the video signal from left to right, upside down, or vice versa to your convenience.

## POSI/NEGA

You can set the video brightness signal to normal or reverse.

## PIP

You can view a main image with a sub image on the same screen.

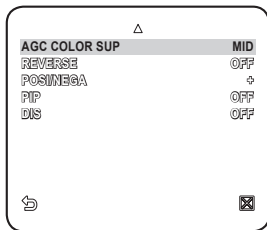

- 
 ■ If more than one PRIVACY ZONE is specified, and PRIVACY SET to <ON>, the PIP function is not available.
- As long as SENSE UP is set to FIXED, PIP menu is not available.
- According to the luminance, PIP will disappear if the SENSE UP menu is set to AUTO.

## DIS (Digital Image Stabilization)

If you set it to <ON> for a camera that is trembled or vibrated from an ambient change, this will automatically compensate for the flicker on the screen.

- 
 ■ If you set <DIS> to <ON>, the image will be enlarged with digital zoom as much area as compensated. (Approximately 1.2 times of the optical zoom factor)  
If you set the digital zoom to a larger ratio than the actual enlargement for compensation, the <DIS> function will be disabled.
- <DIS> may not work properly in the following images:  
Single-colored flat image / Low contrast scene / High frequency image taken under a fluorescent lamp / Regular-patterned image

## INTELLIGENT VIDEO

You can enable the motion detection and tracking functions.

For selecting and saving each menu item, refer to "How to use the keyboard controller". (page 22)

1. Select <MAIN MENU>-<INTELLIGENCE>.
2. Select each item and set appropriately.

### MOTION

You can enable the motion detection and tracking functions.

- 
 ■ If you set it to <DETECTION>, the <FIXED/MOVED> option of ADVANCED menu will not be available.
- In following situations, motion detection and tracking function may not work properly.
  - When there is sudden changes of brightness
  - When the device moves
  - When a certain object's movement fills most of the framing area
  - When there is difficulties in distinguishing the moving object and background

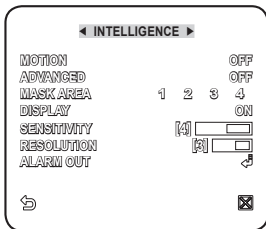

## ADVANCED

You can detect motions and mark the video that contains such motion, and enables tracking of the movement. (The auto PTZ function is not supported for tracking an object.) Selecting the **<FIXED/MOVED>** option will mark a region if an existing object disappears, or a new object appears and fixed for a certain period of time.



- In following situations, FIXED/MOVED detection may not work properly.
  - When multiple motions continue arbitrarily.
  - When the object that is fixed continues to move in the same position.
  - When a newly appearing object conceals another object that is moving.

## MASK AREA

1. Select the number of the area to be masked that will be excluded from motion detection.
2. Select the mask number and set the mask size and its coverage.

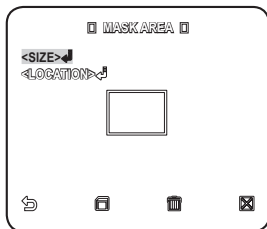

## DISPLAY

When selected **<ON>**, it displays the motion detected and detection of configured advanced function.

## SENSITIVITY

Sets the sensitivity of motion sensor.

## RESOLUTION

The bigger the resolution setting, the smaller the object that can be detected.

## ALARM OUT

When selected **<ON>**, it outputs alarm signal when the motion is detected and on a detection of configured advanced function.

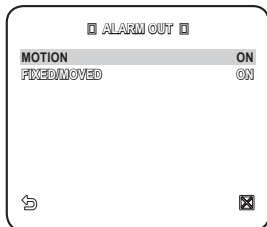

# PRIVACY ZONE

You can set up to 12 privacy zones that will be hided for privacy of the subject when recording.

## Zone Setup

For selecting and saving each menu item, refer to "How to use the keyboard controller". (page 22)

1. Select <MAIN MENU>-<PRIVACY ZONE>.
2. Select the number of the zone and press [ENTER].  
The Zone setup screen appears.
3. Select the <SET P/T/Z> and press [ENTER].  
Using the joystick, adjust the camera's pan, tilt and zoom.

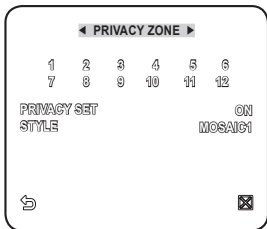

4. Select the <PIXEL LEVEL>.  
Select the pixel level for the SIZE and LOCATION settings.
5. Select <POINT> and press [ENTER]. The Privacy zone would be marked each time you press [ENTER].
6. Use the joystick to set the position of each point (top left, top right, bottom right, bottom left), and press [ENTER]. Position setting is completed.
7. Save the changes and move to the previous screen and select the <STYLE>.  
Select the <COLOR> and pick a desired color.

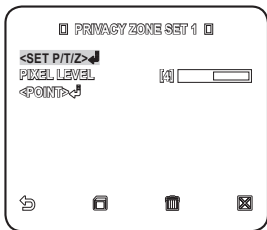

-  ■ Setting one or more privacy zone and enabling privacy function will disable the PIP function.
- For better privacy protection, make your privacy zone bigger than the required, bigger by about 30%.
- Video portion of mosaic pattern or colored by the privacy zone setup is not recoverable.

## PRESET

This function provides preset camera settings such as pan, tilt, zoom and focus so to enable quicker and easier accessing and monitoring, which supports up to 512 presets.

For selecting and saving each menu item, refer to "How to use the keyboard controller". (page 22)

1. Select <MAIN MENU>-<PRESET>.

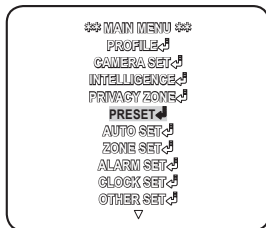

2. Select the preset number.

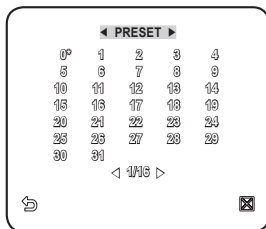

3. Select <POSITION> and adjust <PAN/ TILT/ZOOM> to the desired setup using the joystick.
4. Set <PRESET ID> to <ON> and enter the name.
  - For entering the name, refer to "CAMERA ID". (page 26)

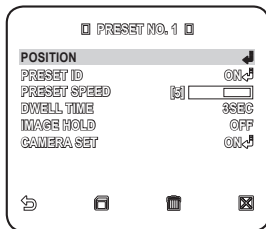

5. Select **<PRESET SPEED>** and adjust the pan/tilt speed of the preset.
6. Set the **<DWELL TIME>** that defines the camera's hold duration and **<IMAGE HOLD>** of the preset.
  - If you set the **<IMAGE HOLD>** to **<ON>**, the video image will be held still until the camera reaches the preset position.
7. Set **<CAMERA SET>** to **<ON>**.  
You can adjust camera setups for each preset.
  - For details on setting **<IRIS>**, **<WHITE BAL>** and **<FOCUS MODE>**, refer to "**CAMERA SET**". (pages 26 ~ 35)

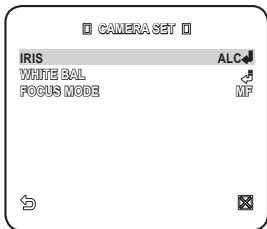

- 
  - The preset position can be specified for a tilt range of between  $-6^{\circ}$  and  $90^{\circ}$ . Those presets that are out of a tilt of  $90^{\circ}$  can not be specified.
  - If you try to specify a preset position for a range exceeding a tilt of  $90^{\circ}$  using a controller (SSC-1000, 2000 or 5000), you will see a message of **<SET AGAIN>** on the screen. If this is the case, try again for a range below a tilt of  $90^{\circ}$ .
  - If you upload/download the menu setting using SSC-1000, 2000 or 5000, the preset may differ from the menu setting so define the preset again after the operation.

## AUTO SET

You can set the AUTO PAN, PATTERN, and AUTO PLAY.



- If you upload/download the menu setting using SSC-1000, 2000 or 5000, the settings for AUTO PAN, PATTERN, SCAN, and PRESET may differ from the menu settings so define them again after the operation.

### Auto Pan Setup

Set the starting and ending positions to patrol between points at specified speed.

For selecting and saving each menu item, refer to "How to use the keyboard controller". (page 22)

1. Select <MAIN MENU>-<AUTO SET>.

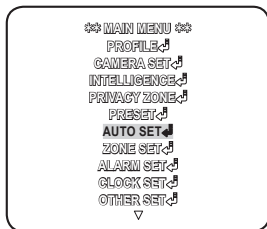

2. Select the number of <AUTO PAN>. AUTO PAN setup screen appears.

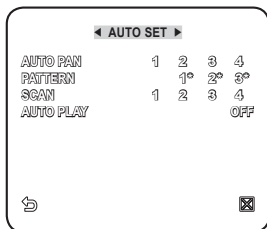



### 3. Select each item and set appropriately.

- **POSITION** : Set the starting and ending positions for the <AUTO PAN>. Move to the setting screen and adjust pan/tilt to the desired starting position, and then press [ENTER]. Again, adjust pan/tilt to the desired ending position and press [ENTER] to finish <AUTO PAN> setup.

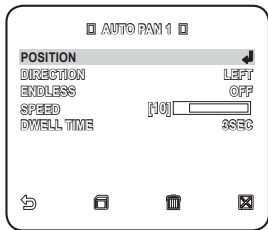

- **DIRECTION** : Sets the direction of the camera's movement from the starting to the end position. (Based on panning)



- **ENDLESS** : Instead of shuttling between start and end positions, the camera turns 360° endlessly while stops for the <DWELL TIME> at both positions.
- **SPEED** : Sets the moving speed of the camera, from 1 to 64.
- **DWELL TIME** : Sets the dwell time at the starting and ending positions, from 1 to 60 seconds.

## Pattern Setup

You can manually record your pan/tilt/zoom movements to a monitoring pattern for up to 2 minutes.

For selecting and saving each menu item, refer to "How to use the keyboard controller". (page 22)

1. Select <MAIN MENU>-<AUTO SET>.
2. Select the pattern number.  
PATTERN setup screen appears.
3. Select the <POSITION> and set the pattern's starting position and press [ENTER].



4. Select the **<START>** and move the camera using pan/tilt/zoom.
5. Your manual camera actions will be recorded for up to 2 minutes, and returns to the previous menu automatically.
  - To stop manual recording and return to the previous menu before 2 minutes, press **[ENTER]**.

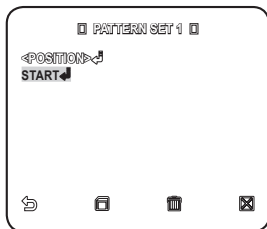



## Scan Setup

You can set the SCAN operation to include a defined preset position.

For selecting and saving each menu item, refer to “**How to use the keyboard controller**”. (page 22)

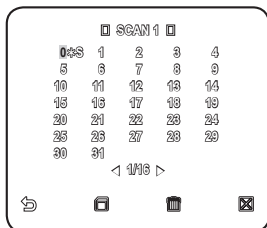
1. Select **<MAIN MENU>**-**<AUTO SET>**.
2. Select the scan number.  
SCAN setup screen appears.
3. Move the cursor to a number with the **[\*]** mark which contains a defined preset.
4. Press **[ENTER]**.  
**[S]** mark appears beside the **[\*]** and the corresponding preset is included in the scan.



-  SCAN numbers configured for a certain page can be saved only in the corresponding page. Make sure to save it before moving to the next page.

## Auto Play Setup

AUTO PLAY runs configured AUTO PAN, PATTERN, and SCAN functions automatically.

For selecting and saving each menu item, refer to "How to use the keyboard controller". (page 22)

1. Select <MAIN MENU>-<AUTO SET>.
2. Select the <AUTO PLAY> and select a number.  
AUTO PLAY setup screen appears.

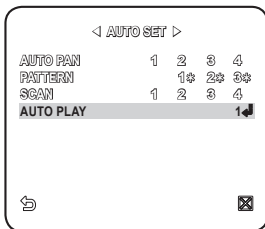

- AUTO PLAY1 : Sets overall function properties of the AUTO PLAY.
  - AUTO RETURN : Sets the interval between auto plays.
  - AUTO PLAY : Sets the auto play action at every auto play interval.  
You can set between 1 ~ 4 for SCAN or AUTO PAN, 1 ~ 3 for PATTERN, and 0 ~ 511 for PRESET.
  - PLAY NUMBER : Sets the number of the defined auto play operation.

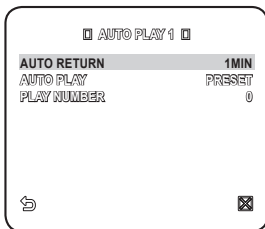

- AUTO PLAY2 : Select the auto play action and set its starting / ending time. When the time hits the defined starting time, configured auto play will begin. You can set between 1 ~ 4 for SCAN or AUTO PAN, 1 ~ 3 for PATTERN, and 0 ~ 511 for PRESET.

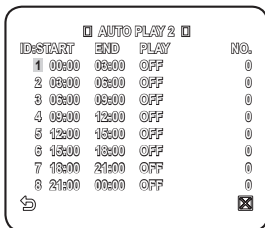

## ZONE SET

You can set the north direction and the zone coverage.

For selecting and saving each menu item, refer to "How to use the keyboard controller". (page 22)

1. Select <MAIN MENU>-<ZONE SET>.

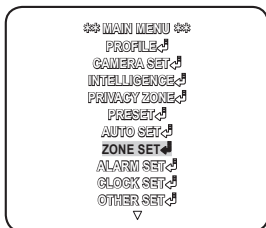

2. Set <AZIMUTH> to <ON>.
3. Set the north direction using the joystick and press [ENTER].
  - SET NORTH : In SET NORTH, press [ENTER] to set the north direction which will be the reference for all other directions.

4. Set <ZONE AREA SET> to <ON>.

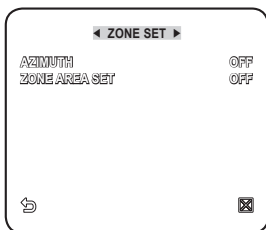

5. When the <ZONE AREA MAP> screen appears, select a number.
6. When the <ZONE AREA SET> screen appears, set the <POSITION> and <ZONE ID SET>.
  - For entering the name, refer to "CAMERA ID". (page 26)
  - POSITION : Sets the left/right boundaries of the zone.

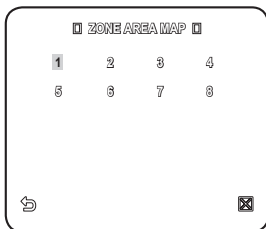

# ALARM SET

It provides 8 alarm inputs and 3 alarm outputs. Detects alarm inputs from the external sensors cooperating with configured presets, patterns, and scan functions, and produces alarm outputs. Alarm's dwell time is defined by the corresponding preset's <DWELL TIME> and its alarm action.

For selecting and saving each menu item, refer to "How to use the keyboard controller". (page 22)

1. Select <MAIN MENU>-<ALARM SET>.

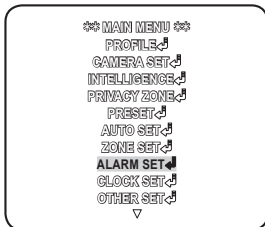

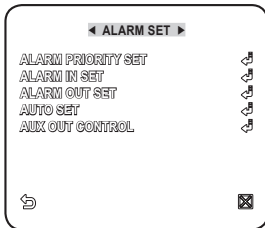

2. Select each item and set appropriately.

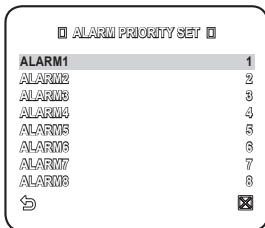

- **ALARM PRIORITY** : Sets the priorities of alarms. Setting the priorities of 8 alarms defines the alarm notification priorities of them in the highest orders. By default, the priorities are set as Alarm 1 ➔ Alarm 2 ➔ ..... ➔ Alarm 8. When multiple alarms are generated at the same time, alarm notifies in the order of the default priority setting. While an alarm is generating, no motion is detected.



- **ALARM IN SET** : Select the alarm sensor operation between <NO>, <NC> and <OFF>.
- **ALARM OUT SET** : Set the alarm out port matched to the alarm input port.
- **AUTO SET** : Sets the pattern and scan action for the corresponding alarm input. When the alarm is generated, the camera moves to the preset position coupled to the corresponding alarm. Presets 1 ~ 8 are coupled with alarms 1 ~ 8 inputs respectively, and the preset 9 is coupled to the motion detection.

AUTO SET	
ALARM1	OFF
ALARM2	OFF
ALARM3	OFF
ALARM4	OFF
ALARM5	OFF
ALARM6	OFF
ALARM7	OFF
ALARM8	OFF
MOTION	OFF
	



The camera stops and remains in the corresponding preset position for the defined <DWELL TIME>, and performs pattern or scan action defined by the <AUTO SET>. Setting to <OFF> will discard with the pattern or scan action after moving to the preset position.

- PATTERN 1 ~ 3 : Defined pattern action
- HALF1 : Patterns 1 and 2 in serial action
- HALF2 : Patterns 2 and 3 in serial action
- WHOLE : Patterns 1, 2 and 3 in serial action
- SCAN 1 ~ 4 : Predefined SCAN action



- The <ALARM1> is used as external switching signal if the <DAY/NIGHT> is set to <EXT>.

- **AUX OUT CONTROL** : Sets whether to sustain the alarm output despite of the alarm generation or to output alarm out signal while the coupled alarm is alive. When selected <OFF>, outputs alarm only if the alarm is generated. When selected <ON>, it always outputs alarm out signal despite of the alarm generation.

AUX OUT CONTROL	
OUT1	OFF
OUT2	OFF
OUT3	OFF
	

## CLOCK SET

Sets whether to display the clock on the screen and its time format.

For selecting and saving each menu item, refer to "How to use the keyboard controller". (page 22)

1. Select <MAIN MENU>-<CLOCK SET>.
2. Select <DISPLAY> and set whether to display the time on the screen.
3. Select the time format and set the clock.
4. Select the date format and set the date.

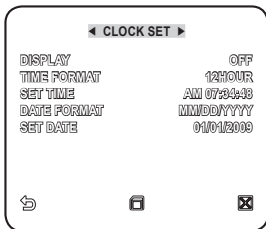

## OTHER SET

You can reset the system by running FACTORY DEFAULTS, or set the font color, zoom, turbo pan/tilt, etc.

For selecting and saving each menu item, refer to "How to use the keyboard controller". (page 22)

1. Select <MAIN MENU>-<OTHER SET>.
2. Select each item and set appropriately.

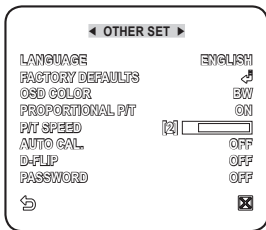

## Language

Select <LANGUAGE> and use the left/right button to select a preferred display language.

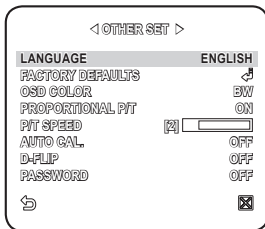

## FACTORY DEFAULTS

When selected, the <FACTORY DEFAULTS> screen appears and you can reset all settings to the factory default settings by selecting the <OK>. However, the protocol, baud rate, address and the language settings will not be reset.



- Note that the resetting the system to the factory default will erase all settings data.



## OSD COLOR

Selects the color of the on-screen display font.

## PROPORTIONAL P/T

When selected <ON>, manual pan / tilt movement speed will vary proportionally to the zoom ratio.

## P/T SPEED

When selected <ON>, manual pan / tilt movement speed will be doubled.



## AUTO CAL. (AUTO CALIBRATION)

To enhance the lens and pan/tilt motor's accuracy, the automatic compensation function is provided. It automatically resets the lens and pan/tilt when there is no user operation for a specified time period.

## D-FLIP (DIGITAL FLIP)

When selected <ON>, the displayed screen will be flipped vertically and horizontally if the subject turns over 90°.

## PASSWORD

When selected <ON>, it is asked to enter the password for accessing the menu. Select the numbers using direction keys and press [ENTER].

- The default password is "4321".

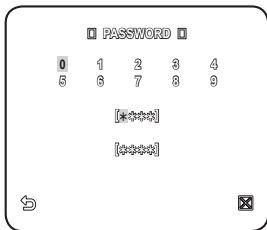

## COMMUNICATION

You can set the RS-485 communications setting in regard of the camera.

For selecting and saving each menu item, refer to "How to use the keyboard controller". (page 22)

1. Select <MAIN MENU>-<COMMUNICATION>.

2. Select each item and set appropriately.

- PRIORITY : Set the priority by selecting <HW> or <SW>. When selected <HW>, the protocol, baud rate and address settings will follow those settings of the adaptor switch.
- PROTOCOL, BAUD RATE, ADDRESS : When selected <SW>, you can manually set the protocol, baud rate and address.

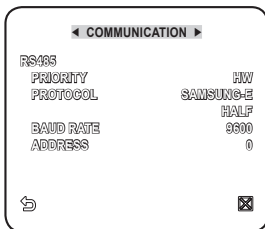

## SYSTEM INFO

---

You can check the system information.

For selecting and saving each menu item, refer to "How to use the keyboard controller". (page 22)

1. Select <MAIN MENU>-<SYSTEM INFO>.
2. The current system information is displayed.

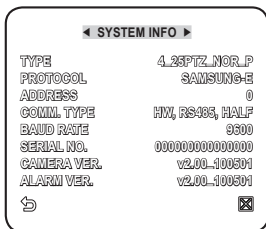

## SHORTCUT KEYS

	Function	Key
CAMERA SET	DAY/NIGHT - DAY	[PRESET] + [5] + [1] + [2] + [ENTER]
	DAY/NIGHT - NIGHT	[PRESET] + [5] + [1] + [3] + [ENTER]
	DAY/NIGHT - AUTO	[PRESET] + [5] + [1] + [4] + [ENTER]
	DAY/NIGHT - EXT	[PRESET] + [5] + [1] + [5] + [ENTER]
	IRIS - ALC	[PRESET] + [5] + [1] + [8] + [ENTER]
	IRIS - MANU	[PRESET] + [5] + [1] + [9] + [ENTER]
	FOCUS MODE - AF	[PRESET] + [5] + [2] + [0] + [ENTER]
	FOCUS MODE - MF	[PRESET] + [5] + [2] + [1] + [ENTER]
	FOCUS MODE - ONEAF	[PRESET] + [5] + [2] + [2] + [ENTER]
ALARM SET	AUX OUT CONTROL - OUT1 - ON	[PRESET] + [5] + [2] + [3] + [ENTER]
	AUX OUT CONTROL - OUT1 - OFF	[PRESET] + [5] + [2] + [4] + [ENTER]
	AUX OUT CONTROL - OUT2 - ON	[PRESET] + [5] + [2] + [5] + [ENTER]
	AUX OUT CONTROL - OUT2 - OFF	[PRESET] + [5] + [2] + [6] + [ENTER]
	AUX OUT CONTROL - OUT3 - ON	[PRESET] + [5] + [2] + [7] + [ENTER]
	AUX OUT CONTROL - OUT3 - OFF	[PRESET] + [5] + [2] + [8] + [ENTER]
OTHER SET	PROPORTIONAL P/T - ON	[PRESET] + [5] + [2] + [9] + [ENTER]
	PROPORTIONAL P/T - OFF	[PRESET] + [5] + [3] + [0] + [ENTER]
	P/T SPEED - 9	[PRESET] + [5] + [3] + [1] + [ENTER]
	P/T SPEED - 5	[PRESET] + [5] + [3] + [2] + [ENTER]
	D-FLIP - ON	[PRESET] + [5] + [3] + [3] + [ENTER]
	D-FLIP - OFF	[PRESET] + [5] + [3] + [4] + [ENTER]
AUTO SET	AUTO PLAY - 1	[PRESET] + [5] + [3] + [5] + [ENTER]
	AUTO PLAY - 2	[PRESET] + [5] + [3] + [6] + [ENTER]
	AUTO PLAY - OFF	[PRESET] + [5] + [3] + [7] + [ENTER]
Function	Running A.C (Auto Calibration)	[PRESET] + [5] + [3] + [8] + [ENTER]

## SPECIFICATIONS

Item	Description			
Product Type	SMART DOME CAMERA			
Power Source	AC 24 V (50 Hz) Use an adaptor over 3A when the heater works.			
Power Consumption	16.3W(Camera, Fan) / 47W(Heater ON)			
TV Standard	NTSC / PAL STANDARD COLOR SYSTEM			
Image Sensor	Super-HAD IT CCD			
Effective Pixels	PAL-752(H) × 582(V) NTSC-768(H) × 494(V)			
TV line frequency	PAL-Horizontal : 15, 625 Hz (INT) / 15, 625 Hz (L/L) Vertical : 50 Hz (INT) / 50 Hz (L/L) NTSC-Horizontal : 15, 734 Hz (INT) / 15, 750 Hz (L/L) Vertical : 59.94 Hz (INT) / 60 Hz (L/L)			
Synchronization	INT/LINE LOCK			
Resolution	Horizontal : 600 TV LINES Vertical : 350 TV LINES			
S/N Ratio	Approximately 52 dB			
Minimum subject illumination	SENS-UP	Illumination	Color	B/W
	Off	50IRE	0.20 Lux	0.02 Lux
	Off	30IRE	0.12 Lux	0.012 Lux
	Off	15IRE	0.06 Lux	0.006 Lux
	x512	50IRE	0.00039 Lux	0.00004 Lux
	x512	30IRE	0.00023 Lux	0.00002 Lux
	x512	15IRE	0.00012 Lux	0.00001 Lux
Signal Output	COMPOSITE VIDEO OUT : 1.0 V <sub>p-p</sub> 75 ohms/BNC			
Lens	x25 Zoom Lens Integrated Focal length : 3.6 ~ 115.6mmmm Aperture : F1.65(Wide) F3.0(Tele) - MOD(Minimum Object Distance) : 1000mm			

Item	Description
<b>PAN</b>	PAN range : 360°Endless Preset Pan Speed : 600°/sec, maximum Manual Pan Speed : 0.01°~ 180°/sec
<b>TILT</b>	Tilt range : -6°~186° Preset Tilt Speed : 600°/sec, maximum Manual Tilt Speed : 0.01°~ 180°/sec
<b>Remote Control</b>	RS485(Half&Full Duplex)/RS422, Data on Coaxial Cable
<b>Alarm</b>	Alarm Inputs : 8 IN Alarm Outputs : 3 OUT (2 Open collector 1 relay)
<b>Operation Temperature</b>	-50°C(absolute minimum) ~ +50°C
<b>Operation Humidity</b>	~90%
<b>Dimensions (Ø x H)</b>	228(Ø) x 256(H)mm
<b>Weight</b>	5.6 Kg
<b>Product Color</b>	Light Gray

**PRODUCT APPEARANCE**

---

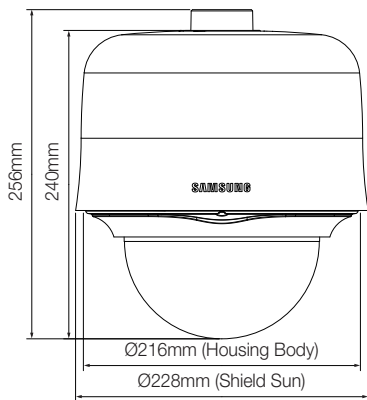
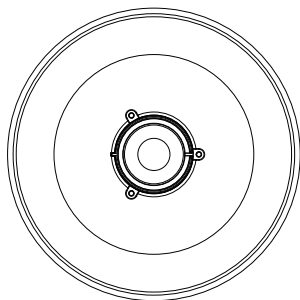



### **Correct Disposal of This Product** (Waste Electrical & Electronic Equipment)

(Applicable in the European Union and other European countries with separate collection systems)

This marking on the product, accessories or literature indicates that the product and its electronic accessories (e.g. charger, headset, USB cable) should not be disposed of with other household waste at the end of their working life. To prevent possible harm to the environment or human health from uncontrolled waste disposal, please separate these items from other types of waste and recycle them responsibly to promote the sustainable reuse of material resources.

Household users should contact either the retailer where they purchased this product, or their local government office, for details of where and how they can take these items for environmentally safe recycling.

Business users should contact their supplier and check the terms and conditions of the purchase contract. This product and its electronic accessories should not be mixed with other commercial wastes for disposal.



## **SALES NETWORK**

---

### **SAMSUNG TECHWIN CO., LTD.**

Samsungtechwin R&D Center, 701, Sampyeong-dong, Bundang-gu, Seongnam-si, Gyeonggi-do, Korea, 463-400  
TEL : +82-70-7147-8740~60 FAX : +82-31-8018-3745

### **SAMSUNG TECHWIN AMERICA Inc.**

1480 Charles Willard St, Carson, CA 90746, UNITED STATES  
Tol Free : +1-877-213-1222 FAX : +1-310-632-2195  
[www.samsungcctvusa.com](http://www.samsungcctvusa.com)

### **SAMSUNG TECHWIN EUROPE LTD.**

Samsung House, 1000 Hillswood Drive, Hillswood Business Park  
Chertsey, Surrey, UNITED KINGDOM KT16 0PS  
TEL : +44-1932-45-5300 FAX : +44-1932-45-5325

---

[www.samsungtechwin.com](http://www.samsungtechwin.com)

[www.samsungsecurity.com](http://www.samsungsecurity.com)