

# SAMSUNG

# FULL MANUAL

---

## HW-M4500 / HW-M4501

Imagine the possibilities









Thank you for purchasing this Samsung product.

To receive more complete service, please register  
your product at [www.samsung.com/register](http://www.samsung.com/register)

# SAFETY INFORMATION

## SAFETY WARNINGS

TO REDUCE THE RISK OF ELECTRIC SHOCK, DO NOT REMOVE THE COVER (OR BACK). NO USER-SERVICEABLE PARTS ARE INSIDE. REFER SERVICING TO QUALIFIED SERVICE PERSONNEL.

	<b>CAUTION</b> <b>RISK OF ELECTRIC SHOCK.</b> <b>DO NOT OPEN.</b>	
	This symbol indicates that high voltage is present inside. It is dangerous to make any kind of contact with any internal part of this product.	
	This symbol indicates that important literature concerning operation and maintenance has been included with this product.	
	Class II product : This symbol indicates that it does not require a safety connection to electrical earth (ground).	
	AC voltage : This symbol indicates that the rated voltage marked with the symbol is AC voltage.	
	DC voltage : This symbol indicates that the rated voltage marked with the symbol is DC voltage.	
	Caution, Consult instructions for use : This symbol instructs the user to consult the user manual for further safety related information.	

## WARNING

- To reduce the risk of fire or electric shock, do not expose this appliance to rain or moisture.

## CAUTION

- TO PREVENT ELECTRIC SHOCK, MATCH WIDE BLADE OF PLUG TO WIDE SLOT, FULLY INSERT.
- This apparatus shall always be connected to a AC outlet with a protective grounding connection.
- To disconnect the apparatus from the mains, the plug must be pulled out from the mains socket, therefore the mains plug shall be readily operable.
- Do not expose this apparatus to dripping or splashing. Do not put objects filled with liquids, such as vases on the apparatus.
- To turn this apparatus off completely, you must pull the power plug out of the wall socket. Consequently, the power plug must be easily and readily accessible at all times.

## Wiring the Main Power Supply Plug (UK Only)

### IMPORTANT NOTICE

The mains lead on this equipment is supplied with a moulded plug incorporating a fuse. The value of the fuse is indicated on the pin face of the plug and if it requires replacing, a fuse approved to BS1362 of the same rating must be used. Never use the plug with the fuse cover removed. If the cover is detachable and a replacement is required, it must be of the same colour as the fuse fitted in the plug. Replacement covers are available from your dealer. If the fitted plug is not suitable for the power points in your house or the cable is not long enough to reach a power point, you should obtain a suitable safety approved extension lead or consult your dealer for assistance.

However, if there is no alternative to cutting off the plug, remove the fuse and then safely dispose of the plug. Do not connect the plug to a mains socket as there is a risk of shock hazard from the bared flexible cord. Never attempt to insert bare wires directly into a mains socket. A plug and fuse must be used at all times.

### **IMPORTANT**

The wires in the mains lead are coloured in accordance with the following code:– BLUE = NEUTRAL BROWN = LIVE As these colours may not correspond to the coloured markings identifying the terminals in your plug, proceed as follows:– The wire coloured BLUE must be connected to the terminal marked with the letter N or coloured BLUE or BLACK. The wire coloured BROWN must be connected to the terminal marked with the letter L or coloured BROWN or RED.



**WARNING : DO NOT CONNECT EITHER WIRE TO THE EARTH TERMINAL WHICH IS MARKED WITH THE LETTER E OR BY THE EARTH SYMBOL , OR COLOURED GREEN OR GREEN AND YELLOW.**

## **PRECAUTIONS**

1. Ensure that the AC power supply in your house complies with the power requirements listed on the identification sticker located on the back of your product. Install your product horizontally, on a suitable base (furniture), with enough space around it for ventilation (7–10 cm). Make sure the ventilation slots are not covered. Do not place the unit on amplifiers or other equipment which may become hot. This unit is designed for continuous use. To fully turn off the unit, disconnect the AC plug from the wall outlet. Unplug the unit if you intend to leave it unused for a long period of time.
2. During thunderstorms, disconnect the AC plug from the wall outlet. Voltage peaks due to lightning could damage the unit.
3. Do not expose the unit to direct sunlight or other heat sources. This could lead to overheating and cause the unit to malfunction.
4. Protect the product from moisture (i.e. vases), and excess heat (e.g. a fireplace) or equipment creating strong magnetic or electric fields. Unplug the power cable from the AC wall socket if the unit malfunctions. Your product is not intended for industrial use. It is for personal use only. Condensation may occur if your product has been stored in cold temperatures. If transporting the unit during the winter, wait approximately 2 hours until the unit has reached room temperature before using.
5. The battery used with this product contains chemicals that are harmful to the environment. Do not dispose of the battery in the general household trash. Do not expose the battery to excess heat, direct sunlight, or fire. Do not short circuit, disassemble, or overheat the battery. Danger of explosion if the battery is replaced incorrectly. Replace only with the same or equivalent type.

# ABOUT THIS MANUAL

The user manual has two parts: this simple paper USER MANUAL and a detailed FULL MANUAL you can download.

	<p><b>USER MANUAL</b></p> <p>See this manual for safety instructions, product installation, components, connections, and product specifications.</p>
 	<p><b>FULL MANUAL</b></p> <p>You can access the customer support centre by scanning the QR code. To see the manual on your PC or mobile device, download the manual in document format from the website. (<a href="http://www.samsung.com/support">http://www.samsung.com/support</a>)</p>









Design and specifications are subject to change without prior notice.

## CONTENTS

<b>01</b>	<b>Checking the Components</b>	<b>2</b>
	Inserting Batteries before using the Remote Control (AA batteries X 2)	2
<b>02</b>	<b>Product Overview</b>	<b>3</b>
	Top Panel / Front Panel of the Soundbar	3
	Bottom Panel of the Soundbar	4
<b>03</b>	<b>Connecting the Soundbar</b>	<b>5</b>
	Connecting Electrical Power	5
	Connecting the Soundbar to the Subwoofer	6
	– Automatic connection between the subwoofer and the Soundbar	6
	– Manually connecting the subwoofer if automatic connection fails	7
<b>04</b>	<b>Connecting to your TV</b>	<b>9</b>
	Method 1. Connecting with a Cable	9
	– Connecting a TV using an HDMI Cable	9
	– Connecting using an Optical Cable	10

	Method 2. Connecting Wirelessly	11
	– Connecting a TV via Bluetooth	11
<b>05</b>	<b>Connecting an External Device</b>	<b>13</b>
	Connecting using an HDMI Cable	13
	Connecting using an Optical or Analogue Audio (AUX) Cable	14
<b>06</b>	<b>Connecting a USB</b>	<b>15</b>
<b>07</b>	<b>Connecting a Mobile Device</b>	<b>17</b>
	Connecting via Bluetooth	17
	Using the Samsung Audio Remote App	20
	– Installing the Samsung Audio Remote App	20
	– Launching the Samsung Audio Remote App	20
<b>08</b>	<b>Using the Remote Control</b>	<b>21</b>
	How to Use the Remote Control	21
	Adjusting the Soundbar volume with a TV remote control	24
	Using the Hidden Buttons	25
	Output specifications for the different sound effect modes	25
<b>09</b>	<b>Installing the Wall Mount</b>	<b>26</b>
	Installation Precautions	26
	Wallmount Components	26
<b>10</b>	<b>Software Update</b>	<b>28</b>
	Updating Procedure	28
	If UPDATE is not displayed	29
<b>11</b>	<b>Troubleshooting</b>	<b>30</b>
<b>12</b>	<b>Licence</b>	<b>31</b>
<b>13</b>	<b>Open Source Licence Notice</b>	<b>31</b>
<b>14</b>	<b>Important Notes About Service</b>	<b>31</b>
<b>15</b>	<b>Specifications and Guide</b>	<b>32</b>
	Specifications	32

# 01 CHECKING THE COMPONENTS

		
Soundbar Main Unit	Subwoofer	Remote Control / Batteries
<b>1</b> 	<b>3</b> 	
Power Cord (Subwoofer)	AC/DC Adapter (Main Unit)	
<b>2</b> 		Connect the AC plug to the adapter until you hear a “snapping” sound to ensure they are securely fastened.
AC Plug (Depending on the country and model)		Do not detach the AC plug from the adapter (it will not be removed once it has been attached).

- The power connection steps are labelled (1, 2, 3). For more information about power connections, see page 5.
- For Soundbar wall mounting components, see page 26.
- HDMI cable is sold separately. To purchase, contact a Samsung Service Centre or Samsung Customer Care.
- Depending on the region, the AC plug may vary in appearance, or it may be supplied integrated with the AC/DC adapter.
- The appearance of the accessories may differ slightly from the illustrations above.

## Inserting Batteries before using the Remote Control (AA batteries X 2)

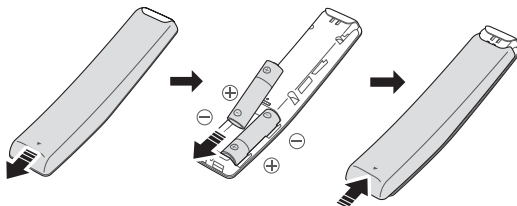

Slide the battery cover in the direction of the arrow until it is completely removed. Insert 2 AA batteries (1.5V) oriented so that their polarity is correct. Slide the battery cover back into position.

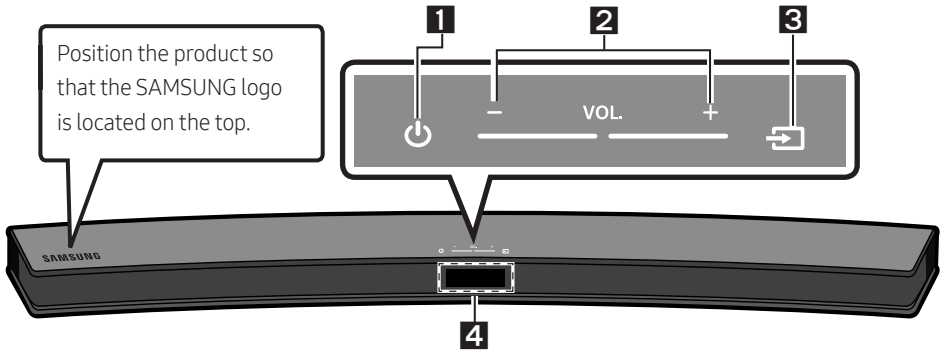

# 02 PRODUCT OVERVIEW

## Top Panel / Front Panel of the Soundbar



<b>1</b>	 <b>(Power) Button</b> Turns the power on and off.														
<b>2</b>	<b>-/+ (Volume) Button</b> Adjusts the volume. <ul style="list-style-type: none"> <li>When adjusted, the volume level appears on the Soundbar's front display.</li> </ul>														
<b>3</b>	 <b>(Source) Button</b> Selects the source input mode. <table border="1" data-bbox="148 896 863 1158"> <thead> <tr> <th>Input mode</th> <th>Display</th> </tr> </thead> <tbody> <tr> <td>Optical Digital input</td> <td>D.IN</td> </tr> <tr> <td>ARC (HDMI OUT) input</td> <td>D.IN → TV ARC (Auto conversion)</td> </tr> <tr> <td>AUX input</td> <td>AUX</td> </tr> <tr> <td>HDMI input</td> <td>HDMI</td> </tr> <tr> <td>BLUETOOTH mode</td> <td>BT</td> </tr> <tr> <td>USB mode</td> <td>USB</td> </tr> </tbody> </table> <ul style="list-style-type: none"> <li>To turn on "<b>BT PAIRING</b>" mode, change the source to "<b>BT</b>" mode, and then press and hold the  <b>(Source)</b> button for more than 5 seconds.</li> </ul>	Input mode	Display	Optical Digital input	D.IN	ARC (HDMI OUT) input	D.IN → TV ARC (Auto conversion)	AUX input	AUX	HDMI input	HDMI	BLUETOOTH mode	BT	USB mode	USB
Input mode	Display														
Optical Digital input	D.IN														
ARC (HDMI OUT) input	D.IN → TV ARC (Auto conversion)														
AUX input	AUX														
HDMI input	HDMI														
BLUETOOTH mode	BT														
USB mode	USB														
<b>4</b>	<b>Display</b> Displays the product's status and current mode.														

- When you plug in the AC cord, the power button will begin working in 4 to 6 seconds.
- When you turn on this unit, there will be a 4 to 5 second delay before it produces sound.
- If you want to enjoy sound only from the Soundbar, you must turn off the TV's speakers in the Audio Setup menu of your TV. Refer to the owner's manual supplied with your TV.

# Bottom Panel of the Soundbar

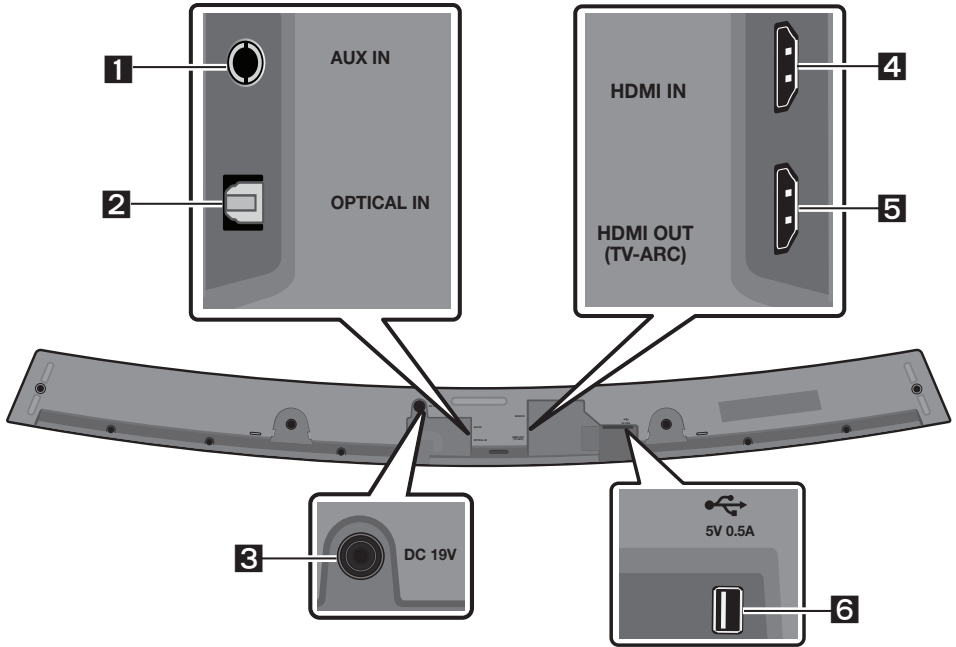

<b>1</b>	<b>AUX IN</b> Connect to the Analogue output of an external device.
<b>2</b>	<b>OPTICAL IN (D.IN)</b> Connect to the digital (optical) output of an external device.
<b>3</b>	<b>DC 19V (Power Supply In)</b> Connect the AC/DC power adaptor.
<b>4</b>	<b>HDMI IN</b> Inputs digital video and audio signals simultaneously using an HDMI cable. Connect to the HDMI output of an external device.
<b>5</b>	<b>HDMI OUT (TV-ARC)</b> Connect to the HDMI (ARC) jack on a TV.
<b>6</b>	 <b>(5V 0.5A)</b> Connect a USB device here to play music files on the USB device through the Soundbar.

- When disconnecting the power cable of the AC/DC power adaptor from a wall outlet, pull the plug. Do not pull the cable.
- Do not connect this unit or other components to an AC outlet until all connections between components are complete.



# 03 CONNECTING THE SOUNDBAR

## Connecting Electrical Power

Use the power components (❶, ❷, ❸) to connect the units to electrical outlets in the following order:

1.) Subwoofer → 2.) Soundbar Main Unit. See the illustrations below.

- For more information about the required electrical power and power consumption, refer to the label attached to the product. (Label : Bottom of the Soundbar Main Unit)

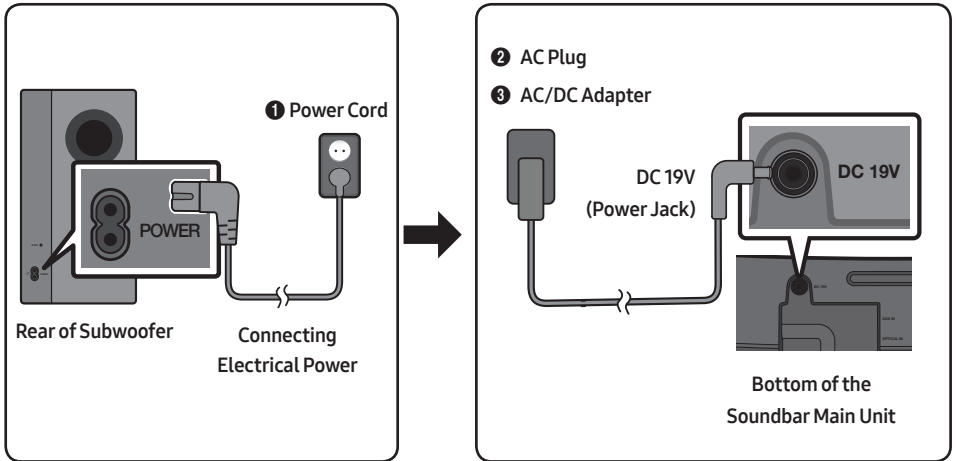

# Connecting the Soundbar to the Subwoofer

When the subwoofer is connected, you can enjoy rich bass sound.

## Automatic connection between the subwoofer and the Soundbar

When you turn the power on after connecting the power cables to the Soundbar and subwoofer, the subwoofer is automatically connected to the Soundbar.

- When auto pairing is complete, the blue indicators at the top of the subwoofer turn on.

## LED Indicator Lights on the top of Subwoofer

LED	Status	Description	Resolution
Blue	On	Successfully connected (normal operation)	-
	Blinking	Recovering the connection	Check if the power cable to the main Soundbar unit is connected properly or wait for a while. (If blinking persists, try manually connecting the subwoofer. See page 7.)
Red	On	Standby (with the Soundbar main unit turned off)	Check if the power cable to the main Soundbar unit is connected properly.
		Connection failed	Connect again. See the instructions for manual connection on page 7.
Red and blue	Blinking	Malfunction	See the contact information for the Samsung Service Centre in the manual.

## Manually connecting the subwoofer if automatic connection fails

### Check before performing the manual connection

- Check whether the power cables for the Soundbar and subwoofer are connected properly.
- Make sure that the Soundbar is turned on.

1. Press and hold **ID SET** on the rear of the subwoofer for at least 5 seconds.

The red indicator on the top of the subwoofer turns off and the blue indicator blinks.

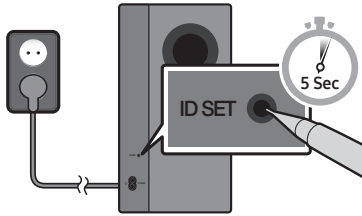

Rear of the Subwoofer

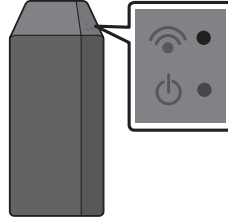

Top of the Subwoofer

2. Turn off the Soundbar.
3. Press and hold the **VOL** button on the remote control for at least 5 seconds with the Soundbar turned off (OFF).
4. The **ID SET** message appears on the display of the Soundbar for 1.3 seconds, and then disappear.

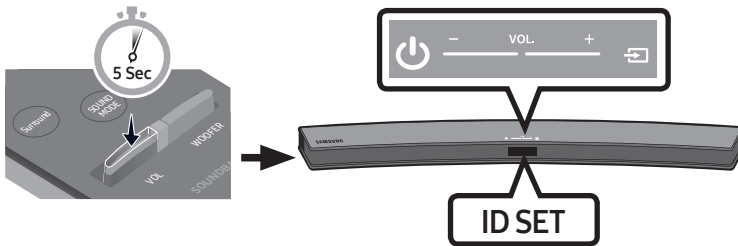

5. When the blue indicator on the subwoofer blinks, turn on the Soundbar's power by pressing **Power** button on the top panel of the main unit or on the remote control.
6. When the connection is successfully established, the blue indicator on the top of the subwoofer stops blinking and glows continuously.
  - If the connection process fails, the blue indicator will flash continuously. Go to Step 1 and start again.

### NOTES

- Do not connect the power cord of this product or your TV to a wall outlet until all connections between components are complete.
- Before moving or installing this product, be sure to turn off the power and disconnect the power cord.

- If the main unit is powered off, the wireless subwoofer will go into stand-by mode and the STANDBY LED on the top will be Red after blinking Blue several times.
- If you use a device that uses the same frequency (5.8GHz) as the Soundbar near the Soundbar, interference may cause some sound interruption.
- The maximum transmission distance of the wireless signal of the main unit is about 10 meters, but may vary depending on your operating environment. If a steel-concrete or metallic wall is between the main unit and the wireless subwoofer the system may not operate at all, because the wireless signal cannot penetrate metal.

## **PRECAUTIONS**

- Wireless receiving antennas are built into the wireless subwoofer. Keep the units away from water and moisture.
- For optimal listening performance, make sure that the area around the wireless subwoofer and Wireless Receiver Module (Sold separately) location is clear of any obstructions.

**Expand to true wireless surround sound by connecting the Samsung Wireless Rear Speaker Kit (SWA-8500S) to your Soundbar (Sold separately). For more information, see the Samsung Wireless Rear Speaker Kit manual.**

# 04 CONNECTING TO YOUR TV

Hear TV sound from your Soundbar through wired or wireless connections.

- When the Soundbar is connected to a selected Samsung TVs, the Soundbar can be controlled using the TV's remote control.
  - When using optical cable, this feature can be supported by 2017 Samsung Smart TVs that support Bluetooth.
  - This function also allows you to use the TV menu to adjust the sound field and various settings as well as the volume and mute.

## Method 1. Connecting with a Cable

### Connecting a TV using an HDMI Cable

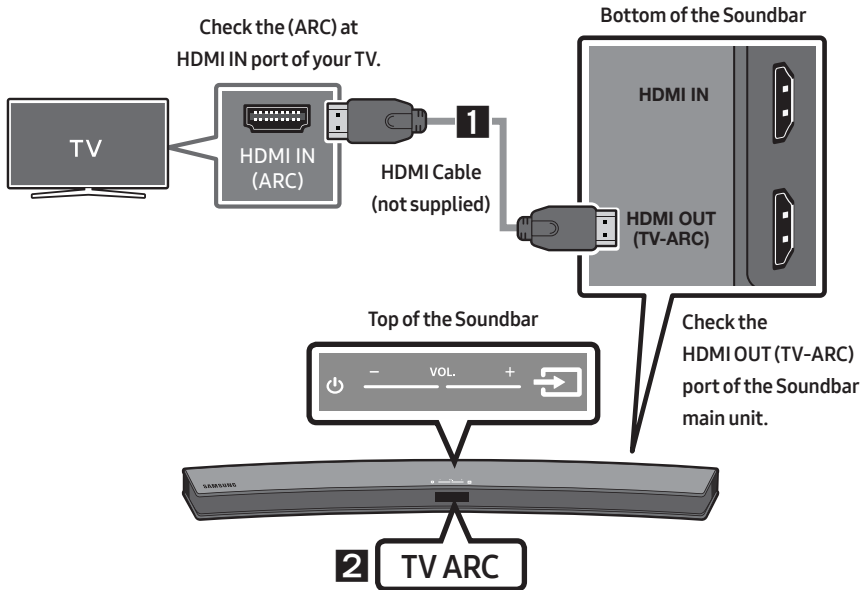

1. With the Soundbar and TV turned on, connect the HDMI cable (not supplied) as shown in the figure.
2. "TV ARC" appears in the display window of the Soundbar main unit and the Soundbar plays TV sound.
  - If TV sound is inaudible, press the  (**Source**) button on the remote control or on the top panel of the Soundbar to switch to "D.IN" mode. The screen displays "D.IN" and "TV ARC" in sequence, and TV sound is played.

- If “**TV ARC**” does not appear in the display window of the Soundbar main unit, confirm that the cable is connected to the correct port.
- Use the volume buttons on the TV’s remote control to change the volume on the Soundbar.

## NOTES

- HDMI is an interface that enables the digital transmission of video and audio data with just a single connector.
- If the TV provides an ARC port, connect the HDMI cable to the HDMI IN (ARC) port.
- We recommend you use a coreless HDMI cable if possible. If you use a cored HDMI cable, use one whose diameter is less than 14 mm.
- Anynet+ must be turned on.
- This function is not available if the HDMI cable does not support ARC.

## Connecting using an Optical Cable

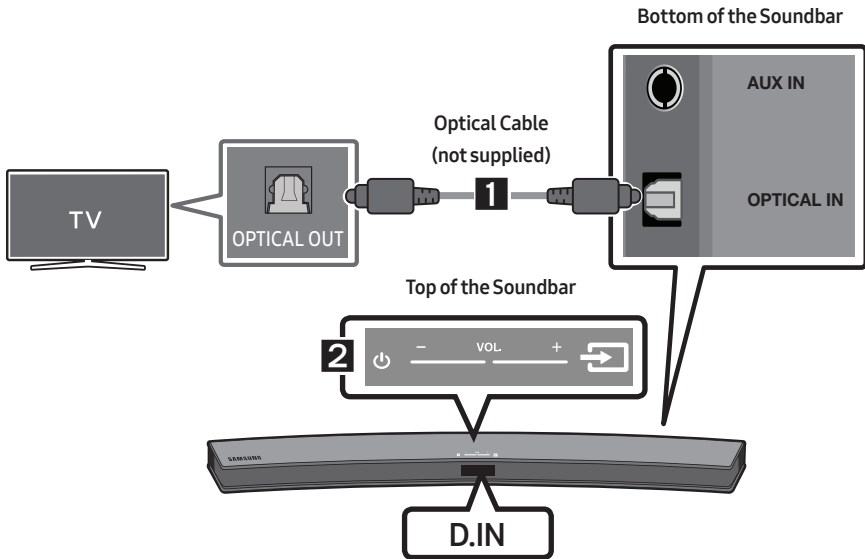

1. Connect the **OPTICAL IN** (Audio) jack on the Soundbar to the **OPTICAL OUT** jack of the TV with a digital optical cable (not supplied).
2. Press the **Source** button on the top panel or remote control, and then select the “**D.IN**” mode.
  - When the Soundbar is connected to a Samsung smart TV released in 2017 or later, the Bluetooth **POWER** function automatically turns on to enable the Soundbar to be controlled with the TV remote control. (See page 23 for details on Bluetooth **POWER**.)

## Auto Power Link

Auto Power Link automatically turns on the Soundbar when the TV is turned on.

1. Connect the Soundbar and a TV with a digital optical cable (not supplied).
2. Press the  (**Source**) button on the top panel or on the remote control, and then select “**D.IN**”.
3. Press the **Left** button on the remote control for 5 seconds to turn Auto Power Link on or off.
  - Auto Power Link is set to ON by default.  
(To turn off this function, turn off Auto Power using the Soundbar.)
  - Depending on the connected device, Auto Power Link may not function.
  - This function is only available in the “**D.IN**” mode.



## Method 2. Connecting Wirelessly



### Connecting a TV via Bluetooth

When a TV is connected using Bluetooth, you can hear stereo sound without the hassle of cabling.

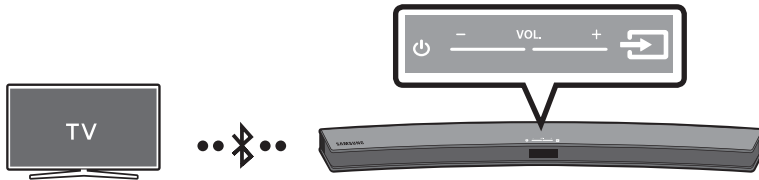
- Only one TV can be connected at a time.



### The initial connection

1. Press the  (**Source**) button on the top panel or on the remote control, and then select “**BT**”.
2. Change “**BT**” to “**BT PAIRING**”.
  - If “**BT READY**” appears, press and hold the  (**Source**) button on the top panel of the Soundbar or on the remote control for more than 5 seconds to display “**BT PAIRING**”.
3. Select Bluetooth mode on the TV. (For more information, see the TV’s manual.)
4. Select “[**AV**] Samsung Soundbar Mxxxx M-Series” from the list on TV’s screen.

An available Soundbar is indicated with “**Need Pairing**” or “**Paired**” on the TV Bluetooth device list. To connect to the Soundbar, select the message and establish a connection.

  - When the TV is connected, [**TV Name**] → “**BT**” appears on the Soundbar’s front display.
5. You can now hear TV sound from the Soundbar.

## If the device fails to connect

- If the previously connected Soundbar listing (e.g. “[AV] Samsung Soundbar Mxxxx M-Series”) appears in the list, delete it.
- In “BT” mode, press and hold the  (Source) button for more than 5 seconds on the top panel of the Soundbar or on the remote control to switch to “BT PAIRING” mode. Then, select “[AV] Samsung Soundbar Mxxxx M-Series” from the TV’s search list.

## What are the BT READY and BT PAIRING statuses?

- **BT READY** : In this mode, you can search for previously connected TVs or connect to the Soundbar from a previously connected mobile device.
- **BT PAIRING** : In this mode, you can connect to a new device. (While in “BT” mode, press and hold the  (Source) button for more than 5 seconds on the top panel of the Soundbar or on the remote control.)

## NOTES

- If asked for a PIN code when connecting a Bluetooth device, enter <0000>.
- In Bluetooth connection mode, the Bluetooth connection will be lost if the distance between the Soundbar and the Bluetooth device exceeds 10 meters.
- The Soundbar automatically turns off after 5 minutes in the Ready state.
- The Soundbar may not perform Bluetooth search or connection correctly under the following circumstances:
  - If there is a strong electrical field around the Soundbar.
  - If several Bluetooth devices are simultaneously paired with the Soundbar.
  - If the Bluetooth device is turned off, not in place, or malfunctions.
- Electronic devices may cause radio interference. Devices that generate electromagnetic waves must be kept away from the Soundbar main unit - e.g., microwaves, wireless LAN devices, etc.

## Disconnecting the Soundbar from the TV

Press the  (Source) button on the top panel or on the remote control and switch to any mode but “BT”.

- Disconnecting takes time because the TV must receive a response from the Soundbar. (The time required may differ, depending on the TV model.)
- To cancel automatic Bluetooth connection between the Soundbar and TV, press the  (Play/Pause) button on the remote control for 5 seconds in “BT READY” status. (Toggle On → Off)



# 05 CONNECTING AN EXTERNAL DEVICE

Connect to an external device via a wired or wireless network to play the external device's sound through the Soundbar.

## Connecting using an HDMI Cable

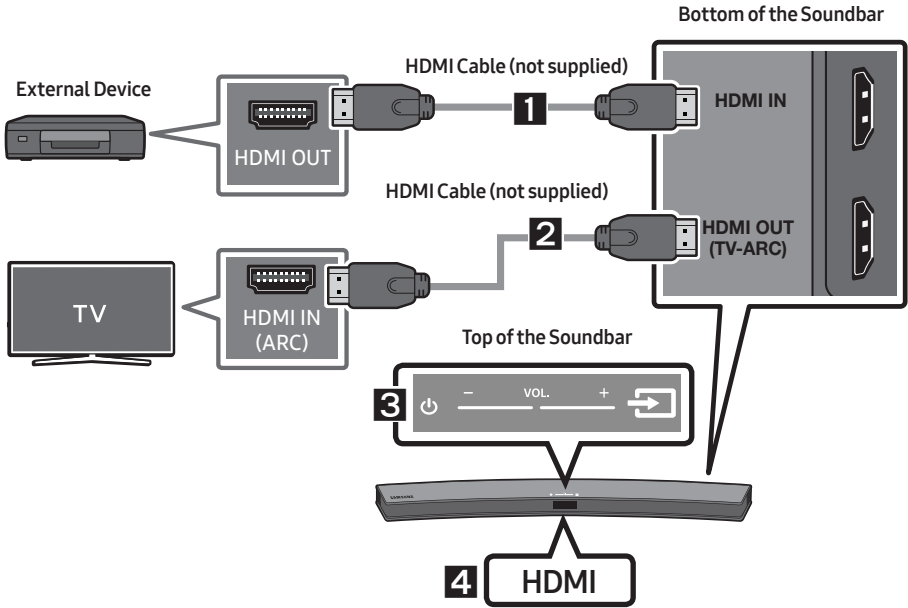

1. Connect an HDMI cable (not supplied) from the **HDMI IN** jack on the back of the product to the HDMI OUT jack on your digital device.
2. Connect an HDMI cable (not supplied) from the **HDMI OUT (TV-ARC)** jack on the back of the product to the HDMI IN jack on your TV.
3. Press the  (**Source**) button on the top panel or on the remote control, and then select **"HDMI"**.
4. **"HDMI"** mode is displayed on the Soundbar display panel and sound plays.

# Connecting using an Optical or Analogue Audio (AUX) Cable

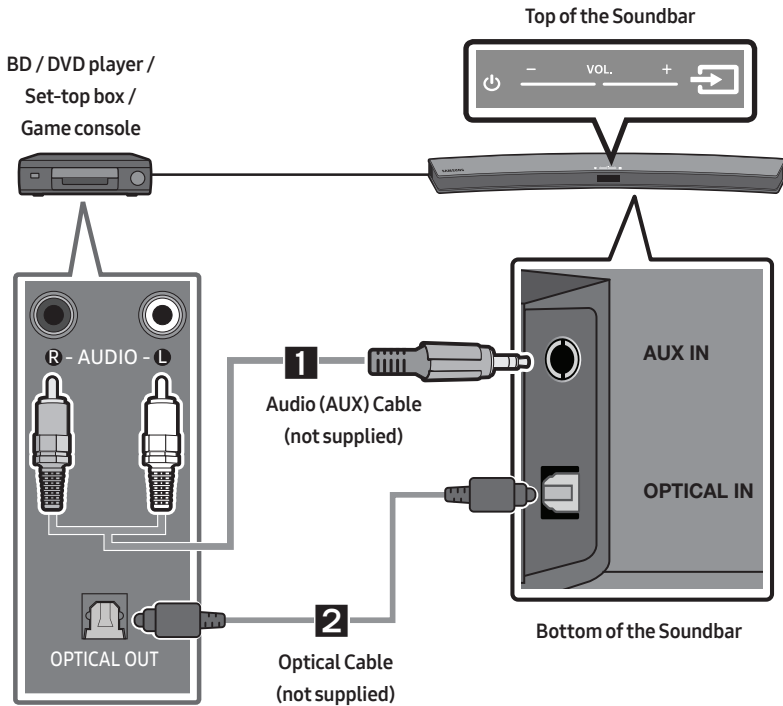

## 1 Audio (AUX) Cable

- 1 Connect **AUX IN** (Audio) on the main unit to the AUDIO OUT jack of the Source Device using an audio cable.
- 2 Select "**AUX**" mode by pressing the  (**Source**) button on the top panel or on the remote control.

## 2 Optical Cable

- 1 Connect **OPTICAL IN** (Audio) on the main unit to the OPTICAL OUT jack of the Source Device using a digital optical cable (not supplied).
- 2 Select "**D.IN**" mode by pressing the  (**Source**) button on the top panel or on the remote control.

## 06 CONNECTING A USB

You can play music files located on USB storage devices through the Soundbar.

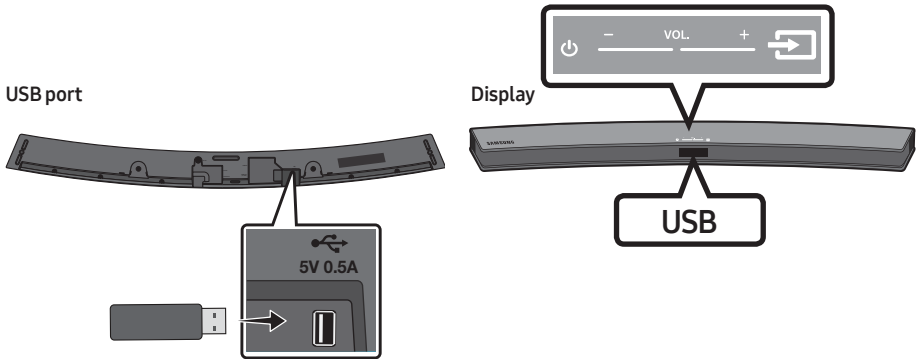

1. Connect the USB device to the USB port on the rear of the product.
2. Press the  (**Source**) button on the top panel or on the remote control and then select “**USB**”.
3. “**USB**” appears in the display screen.
4. Play music files from the USB storage device through the Soundbar.
  - The Soundbar automatically turns off (Auto Power Off) if no USB device has been connected for more than 5 minutes.

## File Format Type Compatibility list

Extension	Codec	Sampling Rate	Bit Rate
<b>*.mp3</b>	MPEG 1 Layer2	16KHz ~ 48KHz	80kbps~320kbps
	MPEG 1 Layer3	16KHz ~ 48KHz	80kbps~320kbps
	MPEG 2 Layer3	16KHz ~ 48KHz	80kbps~320kbps
	MPEG 2.5 Layer3	16KHz ~ 48KHz	80kbps~320kbps
<b>*.wma</b>	Wave_Format_MSAudio1	16KHz ~ 48KHz	56kbps-128kbps
	Wave_Format_MSAudio2	16KHz ~ 48KHz	56kbps-128kbps
<b>*.aac</b>	AAC	16KHz ~ 96KHz	48kbps-320kbps
	AAC-LC	16KHz ~ 96KHz	128kbps-192kbps 5.1ch 320kbps
	HE-AAC	24KHz ~ 96KHz	48kbps~64kbps 5.1ch 160kbps
<b>*.wav</b>	-	16KHz ~ 48KHz	up to 3000kbps
<b>*.ogg</b>	OGG 1.1.0	16KHz ~ 48KHz	50kbps-500kbps
<b>*.flac</b>	FLAC 1.1.0, FLAC 1.2.1	16KHz ~ 96KHz	up to 3000kbps

- If there are too many folders and files stored on the USB device, it may take the Soundbar some time to access and play files.

# 07 CONNECTING A MOBILE DEVICE



## Connecting via Bluetooth

When a mobile device is connected using Bluetooth, you can hear stereo sound without the hassle of cabling.

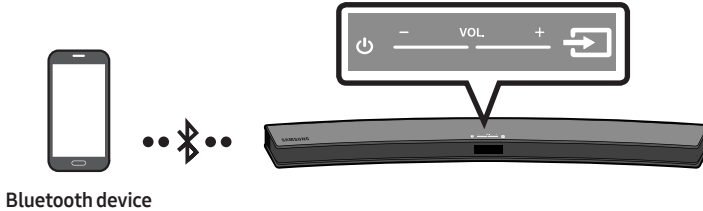
- You cannot connect more than one Bluetooth device at a time.



### The initial connection

1. Press the  (**Source**) button on the top panel or on the remote control, and then select “**BT**”.
2. Change “**BT**” to “**BT PAIRING**”.
  - If “**BT READY**” appears, press and hold the  (**Source**) button on the top panel of the Soundbar or on the remote control for more than 5 seconds to display “**BT PAIRING**”.
3. Select “[**AV**] **Samsung Soundbar Mxxxx M-Series**” from the list.
  - When a Soundbar is connected to the Bluetooth device, [**Bluetooth Device Name**] → “**BT**” appears in the front display.
4. Play music files from the device, connected via Bluetooth, through the Soundbar.

### If the device fails to connect

- If the previously connected Soundbar listing (e.g. “[**AV**] **Samsung Soundbar Mxxxx M-Series**”) appears in the list, delete it.
- In “**BT**” mode, press and hold the  (**Source**) button for more than 5 seconds on the top panel of the Soundbar or on the remote control to switch to “**BT PAIRING**” mode. Then, select “[**AV**] **Samsung Soundbar Mxxxx M-Series**” from the Bluetooth device search list.

## What are the BT READY and BT PAIRING statuses?

- **BT READY** : In this mode, you can search for previously connected TVs or connect to the Soundbar from a previously connected mobile device
- **BT PAIRING** : In this mode, you can connect to a new device. (While in “BT” mode, press and hold the  (Source) button for more than 5 seconds on the top panel of the Soundbar or on the remote control.)

## NOTES

- If asked for a PIN code when connecting a Bluetooth device, enter <0000>.
- In Bluetooth connection mode, the Bluetooth connection will be lost if the distance between the Soundbar and the Bluetooth device exceeds 10 meters.
- The Soundbar automatically turns off after 5 minutes in the Ready state.
- The Soundbar may not perform Bluetooth search or connection correctly under the following circumstances:
  - If there is a strong electrical field around the Soundbar.
  - If several Bluetooth devices are simultaneously paired with the Soundbar.
  - If the Bluetooth device is turned off, not in place, or malfunctions.
- Electronic devices may cause radio interference. Devices that generate electromagnetic waves must be kept away from the Soundbar main unit - e.g., microwaves, wireless LAN devices, etc.
- The Soundbar supports SBC data (44.1kHz, 48kHz).
- Connect only to a Bluetooth device that supports the A2DP (AV) function.
- You cannot connect the Soundbar to a Bluetooth device that supports only the HF (Hands Free) function.
- Once you have paired the Soundbar to a Bluetooth device, selecting “[AV] Samsung Soundbar Mxxxx M-Series” from the device’s scanned devices list will automatically change the Soundbar to “BT” mode.
  - Available only if the Soundbar is listed among the Bluetooth device’s paired devices.  
(The Bluetooth device and the Soundbar must have been previously paired at least once.)
- The Soundbar will appear in the Bluetooth device’s searched devices list only when the Soundbar is displaying “BT READY”.
- Soundbar cannot be paired to another Bluetooth device, while using the Bluetooth function.

## Bluetooth POWER On (Bluetooth POWER)

If a previously paired Bluetooth device tries to pair with the Soundbar when the Bluetooth POWER On function is on and the Soundbar is turned off, the Soundbar turns on automatically.

1. Press the **Bluetooth POWER** button on the remote while the Soundbar is turned on.
2. “ON-BLUETOOTH POWER” appears on the Soundbar’s display.

## Disconnecting the Bluetooth device from a Soundbar

You can disconnect a Bluetooth device from the Soundbar. For instructions, see the Bluetooth device's user manual.

- The Soundbar will be disconnected.
- When the Soundbar is disconnected from the Bluetooth device, the Soundbar will display **"BT DISCONNECTED"** on the front display.

## Disconnecting the Soundbar from the Bluetooth device

Press the  (**Source**) button on the top panel or on the remote control, and then change to any mode except **"BT"**.

- Disconnecting takes time because the Bluetooth device must receive a response from the Soundbar. (Disconnection time may differ, depending on the Bluetooth device)
- When the Soundbar is disconnected from the Bluetooth device, the Soundbar will display **"BT DISCONNECTED"** on the front display.

### NOTES

- In Bluetooth connection mode, the Bluetooth connection will be lost if the distance between the Soundbar and the Bluetooth device exceeds 10 meters.
- The Soundbar automatically turns off after 5 minutes in the Ready state.

### More About Bluetooth

Bluetooth is a technology that enables Bluetooth-compliant devices to interconnect easily with each other using a short wireless connection.

- A Bluetooth device may cause noise or malfunction, depending on usage, if:
  - A part of your body is in contact with the receiving/transmitting system of the Bluetooth device or the Soundbar.
  - It is subject to electrical variation from obstructions caused by a wall, corner, or office partition.
  - It is exposed to electrical interference from same frequency-band devices including medical equipment, microwave ovens, and wireless LANs.
- Pair the Soundbar with the Bluetooth device while they are close together.
- The further the distance between the Soundbar and Bluetooth device, the worse the quality is. If the distance exceeds the Bluetooth operational range, the connection is lost.
- In poor reception areas, the Bluetooth connection may not work properly.
- The Bluetooth connection only works when it is close to the unit. The connection will be automatically cut off if the Bluetooth device is out of range. Even within range, the sound quality may be degraded by obstacles such as walls or doors.
- This wireless device may cause electric interference during its operation.

# Using the Samsung Audio Remote App

## Installing the Samsung Audio Remote App

To control the Soundbar with your smart device and the Samsung Audio Remote app, download the Samsung Audio Remote app from the Google Play store.

Market search : Samsung Audio Remote



## Launching the Samsung Audio Remote App

To launch and use the Samsung Audio Remote app, touch the Audio Remote icon on your smart device, and then follow the directions on the screen.

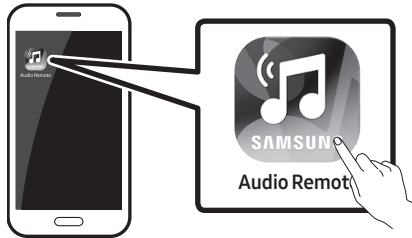





- The Samsung Audio Remote app is only compatible with Android mobile phones and mobile devices running Android OS 3.0 or later.



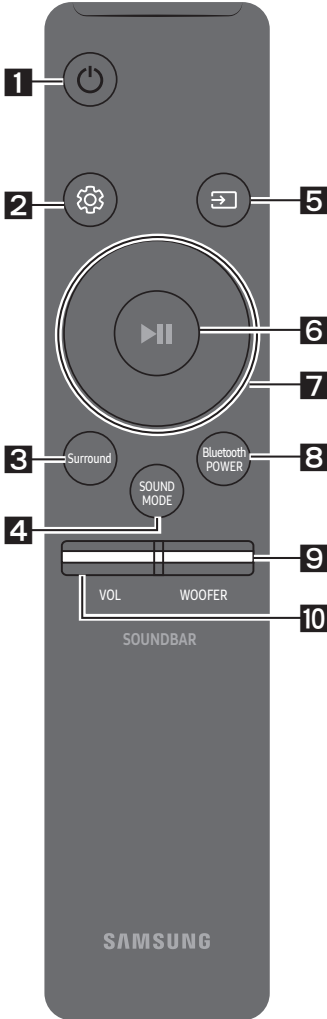



# 08 USING THE REMOTE CONTROL

## How to Use the Remote Control



<p><b>1</b></p>	 <p>Power</p>	<p>Turns the Soundbar on and off.</p>
<p><b>2</b></p>	 <p>Sound Control</p>	<p>You can select from <b>TREBLE</b>, <b>BASS</b>, or <b>AUDIO SYNC</b>.</p> <ul style="list-style-type: none"> <li>To control the volume of the treble or bass sound, select <b>TREBLE</b> or <b>BASS</b> in Sound Settings, and then adjust the volume between -6~+6 by using the <b>Up/Down</b> buttons.</li> <li>Press and hold the  (<b>Sound Control</b>) button for about 5 seconds to adjust the sound for each frequency band. 150Hz, 300Hz, 600Hz, 1.2KHz, 2.5KHz, 5KHz, and 10KHz are selectable (<b>Left/Right</b>) and each can be adjusted to a setting between -6 ~ +6 (<b>Up/Down</b>).</li> <li>If the video and audio between the TV and your Soundbar are not synchronised, select <b>AUDIO SYNC</b> in Sound Settings, and then set audio delay between 0~300 milliseconds by using the <b>Up/Down</b> buttons. (Except “<b>USB</b>” mode)</li> <li>Audio Sync is only supported in some functions.</li> </ul>
<p><b>3</b></p>	 <p>Surround</p>	<p>The Surround Sound function adds depth and a sense of space to sound.</p> <p>Each time you press this button, ON and OFF alternate.</p> <ul style="list-style-type: none"> <li>ON : Play sound over all the speakers.</li> <li>OFF : You can hear the sound of the original source channel from several speakers.</li> </ul>

<p><b>4</b></p>	 <p><b>SOUND MODE</b></p>	<p>You can select the desired sound effect by choosing <b>STANDARD, MUSIC, CLEAR VOICE, SPORTS, or MOVIE.</b></p> <p>Select the “<b>STANDARD</b>” mode if you want to enjoy the original sound.</p> <ul style="list-style-type: none"> <li>• <b>DRC (Dynamic Range Control)</b> Lets you apply dynamic range control to Dolby Digital tracks. If you press and hold the <b>SOUND MODE</b> button while in standby mode, DRC (Dynamic Range Control) turns on or off. With the DRC turned on, loud sound is reduced. (The sound may be distorted.)</li> </ul>
<p><b>5</b></p>	 <p><b>Source</b></p>	<p>Press to select a source connected to the Soundbar.</p> <ul style="list-style-type: none"> <li>• <b>BT PAIRING mode</b> To turn on “<b>BT PAIRING</b>” mode in “<b>BT</b>” mode, press and hold the  (<b>Source</b>) button for more than 5 seconds. See page 17 for details.</li> <li>• <b>Auto Power Down Function</b> The unit turns off automatically in the following situations. <ul style="list-style-type: none"> <li>– <b>D.IN / HDMI / BT / USB Mode</b> : If there is no audio signal for 5 minutes.</li> <li>– <b>AUX Mode</b> : <ul style="list-style-type: none"> <li>– If the Audio (AUX) Cable is disconnected for 5 minutes.</li> <li>– If there is no KEY input for 8 hours when the Audio (AUX) Cable is connected. (Auto Power Down function can be turned off only in that case.)</li> <li>– To turn off Auto Power Down function, while in “<b>AUX</b>” mode, press and hold the <b>▶  </b> button for 5 seconds. “<b>ON-AUTO POWER DOWN</b>” / “<b>OFF-AUTO POWER DOWN</b>” appears on the display.</li> </ul> </li> </ul> </li> </ul>
<p><b>6</b></p>	 <p><b>Play / Pause</b></p>	<p>Press the <b>▶  </b> button to pause a music file temporarily. If you press the button again, the music file plays.</p>

**7**

Up/Down/  
Left/Right



Press the indicated areas to select Up/Down/Left/Right.

Press Up/Down/Left/Right on the button to select or set functions.

- **Repeat**

To use the Repeat function in “USB” mode, press the **Up** button.

- **Music Skip**

Press the **Right** button to select the next music file. Press the **Left** button to select the previous music file.

- **Anynet+ / Auto Power Link**

You can turn Anynet+ and Auto Power Link on or off.

Anynet+ and Auto Power Link are controlled by the **Right** and **Left** buttons respectively.

- Anynet+ : If the Soundbar is connected to a Samsung TV through an HDMI cable, you can control your Soundbar with a Samsung TV remote control. Press and hold the **Right** button for 5 seconds to toggle Anynet+ ON and OFF.
- Auto Power Link : If the Soundbar is connected to your TV through a digital optical cable, the Soundbar can automatically turn on when you turn on your TV. Press and hold the **Left** button for 5 seconds to toggle Auto Power Link ON and OFF.
- Anynet+ / Auto Power Link are set to ON by default.

**8**

Bluetooth  
POWER



Press to turn the Bluetooth POWER or volume restriction function on and off.

- **Bluetooth POWER function** : If the Soundbar is in standby mode and the Bluetooth POWER function is On, when you turn on a previously connected Bluetooth device, the Soundbar automatically turns on and connects via Bluetooth to the device.

- When the Bluetooth POWER function is on, “ON-BLUETOOTH POWER” appears on the Soundbar display. To turn off the Bluetooth POWER function, press the **Bluetooth POWER** button once. Then “OFF-BLUETOOTH POWER” appears on the front display.
- If the “D.IN” mode is on and the Soundbar is connected to a Samsung smart TV released in 2017 or later, the Soundbar can be controlled with the TV remote control. In this mode, you cannot turn off Bluetooth POWER.

- **Volume restriction function** : Because it may damage hearing when the power is turned on at high volumes, it adjusts the volume to 20 when the set volume is higher than 20.

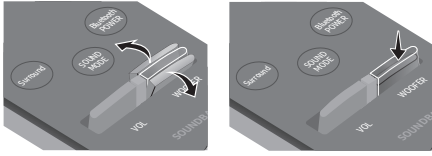
- The default value for Volume restriction is off. The set volume is maintained even when the power is turned off.
- To change the setting, press the **Bluetooth POWER** button on the remote control for 5 seconds. With the volume restriction off, “V FREE” appears on the front display and with the function on, “V LOCK” appears.

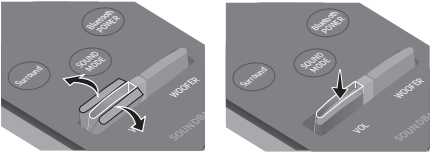
<p><b>9</b></p>	 <p><b>WOOFER</b></p>	 <p>Push the button up or down to adjust the volume of the subwoofer to -12 or -6 to +6. Pressing the button reverts the subwoofer volume to level 0.</p>
<p><b>10</b></p>	 <p><b>VOL</b></p>	 <p>Push the button up or down to adjust the volume.</p> <ul style="list-style-type: none"> <li>• <b>Mute</b> Press the <b>VOL</b> button to mute the sound. Press it again to unmute the sound.</li> </ul>

## Adjusting the Soundbar volume with a TV remote control

Use the TV menu to set the TV speaker on a Samsung TV to external speakers. (For more information, see the TV's user manual.)



- After installing the Soundbar, you can adjust the Soundbar's volume using the IR remote control that came with a Samsung TV. (If you do not want to use this function, when the Soundbar is on, press and hold the **Surround** button for 5 seconds. "OFF-TV REMOTE" appears in the Soundbar's display and the function turns off.)

To adjust the volume using only the Samsung TV remote control, press and hold the **Surround** button for more than 5 seconds until "SAMSUNG-TV REMOTE" appears in the Soundbar display.



- Each time the **Surround** button is held for 5 seconds, the mode switches in the following order: "SAMSUNG-TV REMOTE" (Default mode) → "OFF-TV REMOTE" → "ALL-TV REMOTE".

- To adjust the Soundbar volume with the remote control that came with a TV made by a third party manufacturer, turn the Soundbar on, press and hold the **Surround** button for 5 seconds ("OFF-TV REMOTE" appears on the Soundbar's display), release the **Surround** button, and then press and hold the **Surround** button again for more than 5 seconds. ("ALL-TV REMOTE" appears on the Soundbar's display.)
  - This function may not be available, depending on the remote control.
  - Manufacturers supporting this function:  
VIZIO, LG, Sony, Sharp, PHILIPS, PANASONIC, TOSHIBA, GRUNDIG, Hisense, RCA

## Using the Hidden Buttons

Hidden Button		Reference page
Remote Control Button	Function	
Surround	TV remote control On/Off	page 24
 (Source)	BT Paring	page 17
▶   (Play / Pause)	Auto Power Down On/Off (AUX mode)	page 22
	Initialise (Standby)	page 28
VOL	ID SET (Standby)	page 7
Left	Auto Power Link ON/OFF	page 11
Right	Anynet+ ON/OFF	page 23
 (Sound Control)	7 Band EQ	page 21
SOUND MODE	DRC ON/OFF (Standby)	page 22
Bluetooth POWER	Volume restriction On/Off	page 23

## Output specifications for the different sound effect modes

Effect		Input	Output	
			Except Wireless Rear Speaker Kit	Include Wireless Rear Speaker Kit
 Surround	ON	2.0 ch	2.1 ch	4.1 ch
		5.1 ch	2.1 ch	4.1 ch
 SOUND MODE	STANDARD	2.0 ch	2.1 ch	4.1 ch
		5.1 ch	2.1 ch	4.1 ch
	MUSIC	2.0 ch	2.1 ch	4.1 ch
		5.1 ch	2.1 ch	4.1 ch
	CLEAR VOICE	2.0 ch	2.1 ch	4.1 ch
		5.1 ch	2.1 ch	4.1 ch
	SPORTS	2.0 ch	2.1 ch	4.1 ch
		5.1 ch	2.1 ch	4.1 ch
	MOVIE	2.0 ch	2.1 ch	4.1 ch
		5.1 ch	2.1 ch	4.1 ch

- Samsung Wireless Rear Speaker Kit can be purchased separately. To purchase a Kit, contact the vendor you purchased the Soundbar from.

# 09 INSTALLING THE WALL MOUNT

## Wallmount Components

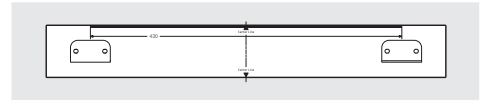

Wall Mount Guide



Holder-Fix Mount  
(2 EA)

Bracket-Wall (2 EA)

### Installation Precautions

- Install on a vertical wall only.
- Do not install in a place with high temperature or humidity.
- Verify whether the wall is strong enough to support the product's weight. If not, reinforce the wall or choose another installation point.
- Purchase and use the fixing screws or anchors appropriate for the kind of wall you have (plaster board, iron board, wood, etc.). If possible, fix the support screws into wall studs.
- Purchase wall mounting screws according to the type and thickness of the wall you want to mount the Soundbar on.
  - Diameter: M5
  - Length: 35 mm or longer recommended.
- Connect cables from the unit to external devices before you install the Soundbar on the wall.
- Make sure the unit is turned off and unplugged before you install it. Otherwise, it may cause an electric shock.

1. Place the **Wall Mount Guide** against the wall surface.

- The **Wall Mount Guide** must be level.
- If your TV is mounted on the wall, install the Soundbar at least 5 cm below the TV.

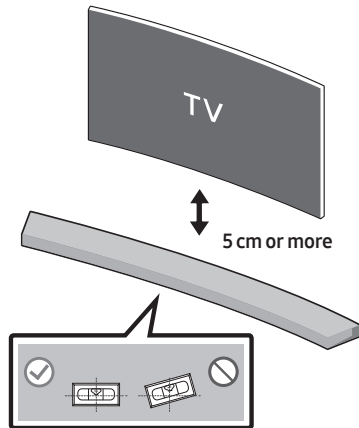

2. Mark the location where the screws will go through on the wall, and then remove the **Wall Mount Guide**. Next, drill holes for the screws using an appropriately sized drill bit.

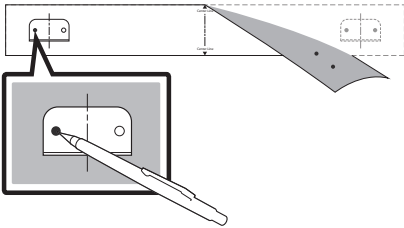

3. Fasten the 2 **Bracket-Wall** pieces firmly to the wall at the marked locations using the appropriate screws.

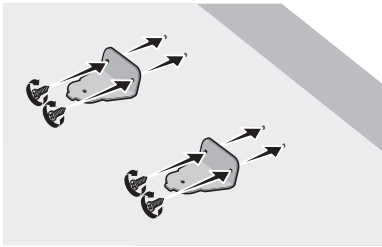

4. Attach the Soundbar to the 2 **Bracket-Wall** pieces as shown in the illustration.

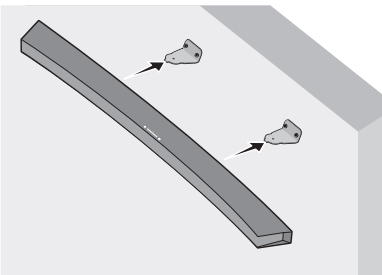

5. Insert a **Holder-Fix Mount** into each hole on the product's bottom side. Tighten each **Holder-Fix Mount** to fix the Soundbar to the 2 **Bracket-Wall** pieces.

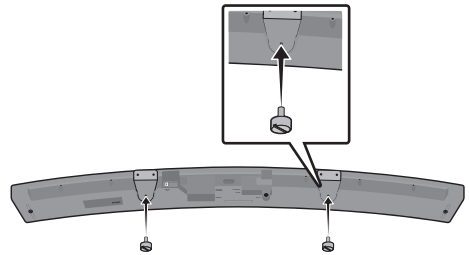

- Do not hang onto the installed unit and avoid striking or dropping the unit.
- Secure the unit firmly to the wall so that it does not fall off. If the unit falls off, it may cause an injury or damage the product.
- When the unit is installed on a wall, please make sure that children do not pull any of the connecting cables, as this may cause it to fall.
- For the optimal performance of a wall mount installation, install the speaker system at least 5 cm below the TV, if the TV is mounted on the wall.
- For your safety, if you do not mount the unit on the wall, install it on a secure, flat surface where it is unlikely to fall.

# 10 SOFTWARE UPDATE

Samsung may offer updates for the Soundbar's system firmware in the future.

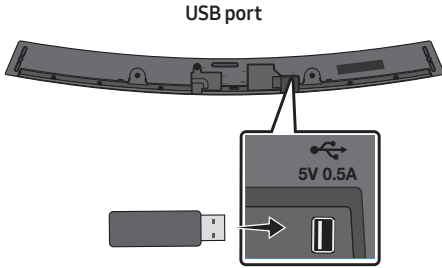

If an update is offered, you can update the firmware by connecting a USB device with the firmware update stored on it to the USB port on your Soundbar.

For more information about how to download update files, go to the Samsung Electronics website at ([www.samsung.com](http://www.samsung.com) → Support). Then, enter or select the model of your Soundbar, select Software & Apps, and then Downloads. The option name can vary.

## Updating Procedure

1. Follow the steps below to download the product software:  
Go to the Samsung website at ([samsung.com](http://samsung.com)) → search for the model name - select the customer support option (the option name is subject to change)
2. Save the downloaded software to a USB stick and select "Extract Here" to unzip the folder.
3. Turn off the Soundbar and connect the USB stick containing the software update to the USB port.
4. Disconnect the power cord, reconnect it, and then turn on the Soundbar.
5. Turn on the Soundbar. Within 3 minutes, "**UPDATE**" is displayed and updating begins.
6. When the update finishes, the Soundbar turns off. Press the ► button on the remote control for 5 seconds. "**INIT**" appears on the display and then the Soundbar turns off. The update is complete.
  - This product has a DUAL BOOT function. If the firmware fails to update, you can update the firmware again.



## If UPDATE is not displayed

1. Turn off the Soundbar, disconnect and then reconnect the USB storage device that contains the update files to the Soundbar's USB port.
2. Disconnect the Soundbar's power cord, reconnect it, and then turn on the Soundbar.
  - Updating firmware may not work properly if audio files supported by the Soundbar are stored in the USB storage device.
  - Do not disconnect the power or remove the USB device while updates are being applied. The main unit will turn off automatically after completing the firmware update.
  - After update is completed, the user setup in Soundbar is initialised. We recommend you write down your settings so that you can easily reset them after the update. Note that updating firmware resets the subwoofer connection too.  
If the connection to the subwoofer is not re-established automatically after the update, refer to page 6.  
If the software update fails, check if the USB stick is defective.
  - Mac OS users should use MS-DOS (FAT) as the USB format.
  - Updating via USB may not be available, depending on the USB storage device manufacturer.

# 11 TROUBLESHOOTING

Before seeking assistance, check the following.

## **The unit will not turn on.**

### **Is the power cord plugged into the outlet?**

→ Connect the power plug to the outlet.

## **A function does not work when the button is pressed.**

### **Is there static electricity in the air?**

→ Disconnect the power plug and connect it again.

## **Sound dropouts occur in BT mode.**

→ See the Bluetooth connection sections on pages 11 and 17.

## **Sound is not produced.**

### **Is the Mute function on?**

→ Press the **VOL** button to cancel the function.

### **Is the volume set to minimum?**

→ Adjust the Volume.

## **The remote control does not work.**

### **Are the batteries drained?**

→ Replace with new batteries.

### **Is the distance between the remote control and Soundbar main unit too far?**

→ Move the remote control closer to the Soundbar main unit.

## **The red LED on the subwoofer blinks and the subwoofer is not producing sound.**

### **This issue can occur if the subwoofer is not connected to the Soundbar main unit.**

→ Try to connect your subwoofer again. (See page 6.)

## **The subwoofer drones and vibrates noticeably.**

### **Try to adjust the vibration of your subwoofer.**

→ Push the **WOOFER** button on your remote control up or down to adjust the subwoofer volume. (between -12, -6 ~ +6).

## 12 LICENCE

---



Manufactured under license from Dolby Laboratories. Dolby, Dolby Audio, Pro Logic, and the double-D symbol are trademarks of Dolby Laboratories.

---



For DTS patents, see <http://patents.dts.com>. Manufactured under license from DTS Licensing Limited. DTS, the Symbol, DTS in combination with the Symbol, and DTS 2.0 Channel are registered trademarks or trademarks of DTS, Inc. in the United States and/or other countries. © DTS, Inc. All Rights Reserved.

---



The terms HDMI and HDMI High-Definition Multimedia Interface, and the HDMI Logo are trademarks or registered trademarks of HDMI Licensing LLC in the United States and other countries.

---

## 13 OPEN SOURCE LICENCE NOTICE

To send inquiries and requests regarding open sources, contact Samsung via Email ([oss.request@samsung.com](mailto:oss.request@samsung.com)).

## 14 IMPORTANT NOTES ABOUT SERVICE

- Figures and illustrations in this User Manual are provided for reference only and may differ from actual product appearance.
- An administration fee may be charged if either
  - (a) an engineer is called out at your request and there is no defect with the product (i.e. where the user manual has not been read).
  - (b) you bring the unit to a repair centre and there is no defect with the product (i.e. where the user manual has not been read).
- You will be informed of the administration fee amount before a technician visits.

# 15 SPECIFICATIONS AND GUIDE

## Specifications

GENERAL	USB		5V/0.5A
	Weight	Soundbar Main Unit	2.7 kg
		Subwoofer (PS-WM20/PS-WM21)	4.6 kg
	Dimensions (W x H x D)	Soundbar Main Unit	1078.0 x 47.5 x 129.0 mm
		Subwoofer (PS-WM20/PS-WM21)	179.0 x 353.0 x 299.5 mm
	Operating Temperature Range		+5°C to +35°C
Operating Humidity Range		10 % ~ 75 %	
AMPLIFIER	Rated Output power	Soundbar Main Unit	22W x 4, 4 ohm (woofer) 21W x 2, 8 ohm (tweeter)
		Subwoofer (PS-WM20/PS-WM21)	130W, 3 ohm
Supported play formats (DTS 2.0 sound is played in DTS format.)			LPCM 2ch, Dolby Audio™ (supporting Dolby® Digital), DTS
Wireless device output power	BT max transmitter power	100mW at 2.4GHz – 2.4835GHz	
	SRD max transmitter power	25mW at 5.725GHz – 5.825GHz	

### NOTES

- Samsung Electronics Co., Ltd reserves the right to change the specifications without notice.
- Weight and dimensions are approximate.
- For more information about the power supply and power consumption, refer to the label attached to the product. (Label : Bottom of the Soundbar Main Unit)

Overall Standby Power Consumption (W)		2.7W
Bluetooth	Port deactivation method	Press the “Bluetooth POWER” button on the remote control when “BT” mode.

- Hereby, Samsung Electronics, declares that this equipment is in compliance with Directive 2014/53/EU.

The full text of the EU declaration of conformity is available at the following internet address: <http://www.samsung.com> go to Support > Search Product Support and enter the model name.

This equipment may be operated in all EU countries.





### **[Correct disposal of batteries in this product]**

#### **(Applicable in countries with separate collection systems)**

This marking on the battery, manual or packaging indicates that the batteries in this product should not be disposed of with other household waste at the end of their working life. Where marked, the chemical symbols Hg, Cd or Pb indicate that the battery contains mercury, cadmium or lead above the reference levels in EC Directive 2006/66.

If batteries are not properly disposed of, these substances can cause harm to human health or the environment.

To protect natural resources and to promote material reuse, please separate batteries from other types of waste and recycle them through your local, free battery return system.



### **Correct Disposal of This Product (Waste Electrical & Electronic Equipment)**

#### **(Applicable in countries with separate collection systems)**

This marking on the product, accessories or literature indicates that the product and its electronic accessories (e.g. charger, headset, USB cable) should not be disposed of with other household waste at the end of their working life. To prevent possible harm to the environment or human health from uncontrolled waste disposal, please separate these items from other types of waste and recycle them responsibly to promote the sustainable reuse of material resources.

Household users should contact either the retailer where they purchased this product, or their local government office, for details of where and how they can take these items for environmentally safe recycling.

Business users should contact their supplier and check the terms and conditions of the purchase contract. This product and its electronic accessories should not be mixed with other commercial wastes for disposal.

For information on Samsung's environmental commitments and product specific regulatory obligations e.g. REACH, WEEE, Batteries, visit:

[http://www.samsung.com/uk/aboutsamsung/samsungelectronics/corporatecitizenship/data\\_corner.html](http://www.samsung.com/uk/aboutsamsung/samsungelectronics/corporatecitizenship/data_corner.html)



**UNITED KINGDOM**



**EIRE**

This Samsung product is warranted for the period of twelve (12) months from the original date of purchase, against defective materials and workmanship. In the event that warranty service is required, you should return the product to the retailer from whom it was purchased. However, Samsung Authorised Dealers and Authorised Service Centres in other EC Countries will comply with the warranty on the terms issued to purchasers in the country concerned. In case of difficulty, details of our Authorised Service Centres are available from:

**Samsung Electronics U.K. Ltd**  
**Samsung Customer Support Centre**  
**Selectapost 38, Sheffield, S97 3FJ**  
**United Kingdom**

**United Kingdom**  
**Tel : 0330 SAMSUNG (7267864)**  
**[www.samsung.com/uk/support](http://www.samsung.com/uk/support)**

**EIRE**  
**Tel : 0818 717100**  
**[www.samsung.com/ie/support](http://www.samsung.com/ie/support)**

#### ■ WARRANTY CONDITIONS

1. The warranty is only valid if, when warranty service is required, the warranty card is fully and properly completed and is presented with the original invoice or sales slip or confirmation, and the serial number on the product has not been defaced.
2. Samsung's obligations are limited to the repair or, at its discretion, replacement of the product or the defective part.
3. Warranty repairs must be carried out by Authorised Samsung Dealers or Authorised Service Centres. No re-imbusement will be made for repairs carried out by non Samsung Dealers and, any such repair work and damage to the products caused by such repair work will not be covered by this warranty.

4. This product is not considered to be defective in materials nor workmanship by reason that it requires adaptation in order to conform to national or local technical or safety standards in force in any Country other than the one for which the product was originally designed and manufactured. This warranty will not cover, and no re-imbusement will be made for such adaptation nor any damage which may result.
5. This warranty covers none of the following:
  - a) Periodic check ups, maintenance and repair or replacement of parts due to normal wear and tear.
  - b) Cost relating to transport, removal or installation of the product.
  - c) Misuse, including the failure to use this product for its normal purposes or incorrect installation.
  - d) Damage caused by Lightning, Water, Fire, Acts of God, War, Public Disturbances, incorrect mains voltage, improper ventilation or any other cause beyond the control of Samsung.
6. This warranty is valid for any person who legally acquired possession of the product during the warranty period.
7. The consumers statutory rights in any applicable national legislation whether against the retailer arising from the purchase contract or otherwise are not affected by this warranty. Unless there is national legislation to the contrary, the rights under this warranty are the consumers sole rights and Samsung, its subsidiaries and distributors shall not be liable for indirect or consequential loss or any damage to records, compact discs, videos or audio taper or any other related equipment or material.

**SAMSUNG ELECTRONICS (U.K.) LTD.**

© 2017 Samsung Electronics Co., Ltd. All rights reserved.

## Contact SAMSUNG WORLD WIDE

If you have any questions or comments relating to Samsung products, please contact the SAMSUNG customer care Centre.

Country	Contact Centre ☎	Web Site
■ Europe		
U.K	0330 SAMSUNG (7267864)	<a href="http://www.samsung.com/uk/support">www.samsung.com/uk/support</a>
IRELAND (EIRE)	0818 717100	<a href="http://www.samsung.com/ie/support">www.samsung.com/ie/support</a>
GERMANY	06196 77 555 77	<a href="http://www.samsung.com/de/support">www.samsung.com/de/support</a>
FRANCE	01 48 63 00 00	<a href="http://www.samsung.com/fr/support">www.samsung.com/fr/support</a>
ITALIA	800-SAMSUNG (800.7267864)	<a href="http://www.samsung.com/it/support">www.samsung.com/it/support</a>
SPAIN	34902172678	<a href="http://www.samsung.com/es/support">www.samsung.com/es/support</a>
PORTUGAL	808 20 7267	<a href="http://www.samsung.com/pt/support">www.samsung.com/pt/support</a>
LUXEMBURG	261 03 710	<a href="http://www.samsung.com/be_fr/support">www.samsung.com/be_fr/support</a>
NETHERLANDS	088-9090100 (lokaal tarief)	<a href="http://www.samsung.com/nl/support">www.samsung.com/nl/support</a>
BELGIUM	02-201-24-18	<a href="http://www.samsung.com/be/support">www.samsung.com/be/support</a> (Dutch) <a href="http://www.samsung.com/be_fr/support">www.samsung.com/be_fr/support</a> (French)
NORWAY	815 56480	<a href="http://www.samsung.com/no/support">www.samsung.com/no/support</a>
DENMARK	70 70 19 70	<a href="http://www.samsung.com/dk/support">www.samsung.com/dk/support</a>
FINLAND	030-6227 515	<a href="http://www.samsung.com/fi/support">www.samsung.com/fi/support</a>
SWEDEN	0771 726 786	<a href="http://www.samsung.com/se/support">www.samsung.com/se/support</a>
POLAND	801-172-678* lub +48 22 607-93-33 * * (koszt połączenia według taryfy operatora)	<a href="http://www.samsung.com/pl/support">www.samsung.com/pl/support</a>
HUNGARY	0680SAMSUNG (0680-726-7864)	<a href="http://www.samsung.com/hu/support">www.samsung.com/hu/support</a>

Country	Contact Centre ☎	Web Site
AUSTRIA	0800-SAMSUNG (0800-7267864) [Only for Dealers] 0810-112233	<a href="http://www.samsung.com/at/support">www.samsung.com/at/support</a>
SWITZERLAND	0800 726 78 64 (0800-SAMSUNG)	<a href="http://www.samsung.com/ch/support">www.samsung.com/ch/support</a> (German) <a href="http://www.samsung.com/ch_fr/support">www.samsung.com/ch_fr/support</a> (French)
CZECH	800 - SAMSUNG (800-726786)	<a href="http://www.samsung.com/cz/support">www.samsung.com/cz/support</a>
SLOVAKIA	0800 - SAMSUNG (0800-726 786)	<a href="http://www.samsung.com/sk/support">www.samsung.com/sk/support</a>
CROATIA	072 726 786	<a href="http://www.samsung.com/hr/support">www.samsung.com/hr/support</a>
BOSNIA	055 233 999	<a href="http://www.samsung.com/support">www.samsung.com/support</a>
MONTENEGRO	020 405 888	<a href="http://www.samsung.com/support">www.samsung.com/support</a>
SLOVENIA	080 697 267 (brezplačna številka)	<a href="http://www.samsung.com/si/support">www.samsung.com/si/support</a>
SERBIA	011 321 6899	<a href="http://www.samsung.com/rs/support">www.samsung.com/rs/support</a>
BULGARIA	*3000 Цена в мрежата 0800 111 31, Безплатна телефонна линия	<a href="http://www.samsung.com/bg/support">www.samsung.com/bg/support</a>
ROMANIA	*8000 (apel in retea) 08008-726-78-64 (08008-SAMSUNG) Apel GRATUIT	<a href="http://www.samsung.com/ro/support">www.samsung.com/ro/support</a>
CYPRUS	8009 4000 only from landline, toll free	<a href="http://www.samsung.com/gr/support">www.samsung.com/gr/support</a>
GREECE	80111-SAMSUNG (80111 726 7864) only from land line (+30) 210 6897691 from mobile and land line	<a href="http://www.samsung.com/lt/support">www.samsung.com/lt/support</a>
LITHUANIA	8-800-77777	<a href="http://www.samsung.com/lt/support">www.samsung.com/lt/support</a>
LATVIA	8000-7267	<a href="http://www.samsung.com/lv/support">www.samsung.com/lv/support</a>
ESTONIA	800-7267	<a href="http://www.samsung.com/ee/support">www.samsung.com/ee/support</a>