

# **USER MANUAL**

# ***ProLite***

## **LCD Monitor**

ENGLISH

***ProLite XB2888HS***  
***ProLite X2888HS***

Thank you very much for choosing the iiyama LCD monitor.

We recommend that you take a few minutes to read carefully through this brief but comprehensive manual before installing and switching on the monitor. Please keep this manual in a safe place for your future reference.



**Dear user, we congratulate you on the purchase of your iiyama LCD.**

For details on warranty and locally used pixel policies that apply directly after installation of your product please check the iiyama website.

**To report a fault, please contact your local support centre found at [www.iiyama.com/service](http://www.iiyama.com/service)**

**Things to check before you call the iiyama information line**

- | if the power cable is connected securely and turned on?
- | if the display has been turned on?
- | if the signal cable is connected securely and the correct input selected?
- | if the computer has been restarted with the display connected?
- | if the graphics card is correctly installed with the latest drivers possible?
- | if the correct native resolution has been selected via 'Display Properties'?
- | if the R/G/B signal configuration is correct?
- | if the displays On Screen Menu is shown?
- | if the correct brightness and contrast settings have been set?
- | if given display tolerances and compatibility have been considered?
- | if via the On Screen Menu you have performed a Factory Reset/Recall?

**Before reporting the screen defect, please prepare the following information/evidence:**

- | model number \*
- | purchase receipt and serial number \*
- | name and address for collection
- | telephone/fax number, for availability during the day
- | convenient collection date (date, time)
- | short description of the defect

**Important Note:**

If there is no fault found in the collected equipment after inspection, the transferring party shall incur charges for transport and administration.

If you have checked all of the above and there is still no picture, call our information line for assistance in your country.

\* see the identification plate on the back of the case.

## CE MARKING DECLARATION OF CONFORMITY

This LCD monitor complies with the requirements of the EC/EU Directive 2014/30/EU "EMC Directive", 2014/35/EU "Low Voltage Directive", 2009/125/EC "ErP Directive" and 2011/65/EU "RoHS Directive".

The electro-magnetic susceptibility has been chosen at a level that gives correct operation in residential areas, business and light industrial premises and small-scale enterprises, inside as well as outside of the buildings. All places of operation are characterised by their connection to the public low voltage power supply system.

IİYAMA CORPORATION: Wijkermeerstraat 8, 2131 HA Hoofddorp, The Netherlands

Model No. : PL2888H



We recommend recycling of used product. Please contact your dealer or iiyama service center. Recycle information is obtained via the Internet, using the address:  
<http://www.iiyama.com>

You can access the Web page of different countries from there.

- We reserve the right to change specifications without notice.
- All trademarks used in this user manual are the property of their respective owners.

# TABLE OF CONTENTS

FOR YOUR SAFETY .....	1
SAFETY PRECAUTIONS.....	1
SPECIAL NOTES ON LCD MONITORS .....	3
CUSTOMER SERVICE .....	3
CLEANING .....	3
BEFORE YOU OPERATE THE MONITOR .....	4
FEATURES.....	4
CHECKING THE CONTENTS OF THE PACKAGE .....	4
WALL MOUNTING .....	5
FITTING AND REMOVAL OF BASE : ProLite XB2888HS .....	6
FITTING AND REMOVAL OF BASE : ProLite X2888HS .....	7
CONTROLS AND CONNECTORS : ProLite XB2888HS .....	8
CONTROLS AND CONNECTORS : ProLite X2888HS.....	9
CONNECTING YOUR MONITOR : ProLite XB2888HS.....	10
CONNECTING YOUR MONITOR : ProLite X2888HS .....	11
COMPUTER SETTING .....	12
ADJUSTING THE HEIGHT AND THE VIEWING ANGLE :	
ProLite XB2888HS .....	12
ADJUSTING THE VIEWING ANGLE : ProLite X2888HS .....	13
OPERATING THE MONITOR.....	14
ADJUSTMENT MENU CONTENTS .....	15
SCREEN ADJUSTMENTS .....	22
POWER MANAGEMENT FEATURE.....	25
TROUBLE SHOOTING .....	26
RECYCLING INFORMATION.....	27
APPENDIX .....	28
SPECIFICATIONS : ProLite XB2888HS .....	28
SPECIFICATIONS : ProLite X2888HS.....	29
DIMENSIONS : ProLite XB2888HS .....	30
DIMENSIONS : ProLite X2888HS.....	30
COMPLIANT TIMING .....	31

# FOR YOUR SAFETY

## SAFETY PRECAUTIONS

### WARNING

#### **STOP OPERATING THE MONITOR IF YOU ARE AWARE OF ANY PROBLEMS**

If you notice any abnormal phenomena such as smoke, strange sounds or fumes, unplug the monitor and contact your dealer or iiyama service center immediately. Further use may be dangerous and can cause fire or electric shock.

#### **NEVER REMOVE THE CABINET**

High voltage circuits are inside the monitor. Removing the cabinet may expose you to the danger of fire or electric shock.

#### **DO NOT PUT ANY OBJECT INTO THE MONITOR**

Do not put any solid objects or liquids such as water into the monitor. In case of an accident, unplug your monitor immediately and contact your dealer or iiyama service center. Using the monitor with any object inside may cause fire, electric shock or damage.

#### **INSTALL THE MONITOR ON A FLAT, STABLE SURFACE**

The monitor may cause an injury if it falls or is dropped.

#### **DO NOT USE THE MONITOR NEAR WATER**

Do not use where water may be splashed or spilt onto the monitor as it may cause fire or electric shock.

#### **OPERATE UNDER THE SPECIFIED POWER SUPPLY**

Be sure to operate the monitor only with the specified power supply. Use of an incorrect voltage will cause malfunction and may cause fire or electric shock.

#### **PROTECT THE CABLES**

Do not pull or bend the power cable and signal cable. Do not place the monitor or any other heavy objects on the cables. If damaged, the cables may cause fire or electric shock.

#### **ADVERSE WEATHER CONDITIONS**

It is advisable not to operate the monitor during a heavy thunder storm as the continual breaks in power may cause malfunction. It is also advised not to touch the plug in these circumstances as it may cause electric shock.

## CAUTION

### INSTALLATION LOCATION

Do not install the monitor where sudden temperature changes may occur, or in humid, dusty or smoky areas as it may cause fire, electric shock or damage. You should also avoid areas where the sun shines directly on the monitor.

### DO NOT PLACE THE MONITOR IN A HAZARDOUS POSITION

The monitor may topple and cause injury if not suitably located. Please also ensure that you do not place any heavy objects on the monitor, and that all cables are routed such that children may not pull the cables and possibly cause injury.

### MAINTAIN GOOD VENTILATION

Ventilation slots are provided to keep the monitor from overheating. Covering the slots may cause fire. To allow adequate air circulation, place the monitor at least 10 cm (or 4 inches) from any walls. Do not remove the tilt stand when operating the monitor. Ventilation slots on the back of the cabinet will be blocked and the monitor may overheat if the stand is removed. This may cause fire or damage. Operating the monitor on its back, side, upside down or on a carpet or any other soft material may also cause damage.

### DISCONNECT THE CABLES WHEN YOU MOVE THE MONITOR

When you move the monitor, turn off the power switch, unplug the monitor and be sure the signal cable is disconnected. If you do not disconnect them, it may cause fire or electric shock.

### UNPLUG THE MONITOR

If the monitor is not in use for a long period of time it is recommended that it is left unplugged to avoid accidents.

### HOLD THE PLUG WHEN DISCONNECTING

To disconnect the power cable or signal cable, always pull it by the plug. Never pull on the cable itself as this may cause fire or electric shock.

### DO NOT TOUCH THE PLUG WITH WET HANDS

Pulling or inserting the plug with wet hands may cause electric shock.

### WHEN YOU INSTALL THE MONITOR ON YOUR COMPUTER

Be sure the computer is strong enough to hold the weight of the monitor, otherwise, you may damage your computer.

### REMARK FOR 24/7 USAGE

This product is not specifically designed for 24/7 usage in all environments.

## OTHERS

### ERGONOMIC RECOMMENDATIONS

To eliminate eye fatigue, do not operate the monitor against a bright background or in a dark room. For optimal viewing comfort, the monitor should be just below eye level and 40-60 cm (16-24 inches) away from your eyes. When using the monitor over a prolonged time, a ten minute break every hour is recommended as looking at the screen continuously can cause eye strain.

## SPECIAL NOTES ON LCD MONITORS

The following symptoms are normal with LCD monitors and do not indicate a problem.

- NOTE**
- When you first turn on the LCD monitor, the picture may not fit in the display area because of the type of computer that is used. In this case, adjust the picture position to the correct position.
  - You may find slightly uneven brightness on the screen depending on the desktop pattern you use.
  - Due to the nature of the LCD screen, an afterimage of the previous screen may remain after switching the image, when the same image is displayed for hours. In this case, the screen can be recovered slowly by changing the image or turning off the Power Switch for some hours.

## CUSTOMER SERVICE

- NOTE**
- If you have to return your unit for service and the original packaging has been discarded, please contact your dealer or iiyama service center for advice or replacement packaging.

## CLEANING

- WARNING**
- If you drop any materials or liquids such as water into the monitor when cleaning, unplug the power cable immediately and contact your dealer or iiyama service center.

- CAUTION**
- For safety reasons, turn off the power switch and unplug the monitor before you clean it.

- NOTE**
- To protect the LCD panel, do not scratch or rub the screen with a hard object.
  - Never use any of the following strong solvents. These will damage the cabinet and the LCD screen.

Thinner	Spray-type cleaner
Benzine	Wax
Abrasive cleaner	Acid or Alkaline solvent

- Touching the cabinet with any product made from rubber or plastic for a long time may cause degeneration or loss of paint on the cabinet.

**CABINET** Stains can be removed with a cloth lightly moistened with a mild detergent solvent. Then wipe the cabinet with a soft dry cloth.

**LCD** Periodic cleaning with a soft dry cloth is recommended.

**SCREEN** Don't use tissue paper etc. because these will damage the LCD screen.

## BEFORE YOU OPERATE THE MONITOR

### FEATURES

- ◆ Supports Resolutions up to 1920 × 1080
- ◆ High Contrast 3000:1 (Typical), Adv. Contrast Function Available / Brightness 300cd/m<sup>2</sup> (Typical) / Quick Response Time 5ms (Gray to Gray)
- ◆ Flicker Free
- ◆ Blue Light Reducer
- ◆ X-Res Technology
- ◆ Digital Character Smoothing
- ◆ Stereo Speakers  
2 × 3W Stereo Speakers
- ◆ Plug & Play VESA DDC2B Compliant  
Windows<sup>®</sup> Vista/7/8/8.1/10 Compliant
- ◆ Power Management (VESA DPMS Compliant)
- ◆ VESA Mounting Standard (100mm×100mm) Compliant
- ◆ Keyhole for Security Lock

### CHECKING THE CONTENTS OF THE PACKAGE

The following accessories are included in your package. Check to see if they are enclosed with the monitor. If anything is missing or damaged, please contact your local iiyama dealer or regional iiyama office.

- Power Cable\*<sup>1</sup>
- Stand Base
- Quick Start Guide
- DVI-D Cable
- Screw for stand fixing (3pcs)\*<sup>2</sup>
- Audio Cable
- Safety Guide

#### CAUTION

\*<sup>1</sup> The rating of the Power Cable enclosed in 120V area is 10A/125V. If you are using a power supply higher than this rating, then a power cable with a rating of 10A/250V must be used. However, all guarantees and warranties are void for any problems or damage caused by a power cable not supplied by iiyama.

\*<sup>2</sup> Accessory for ProLite XB2888HS.



## WALL MOUNTING

- WARNING** ■ When you use with the wall mounting, in consideration of thickness of the mounting stage, tighten the M4 Screw with washer which “L” length is 7mm to fasten the monitor. Using the screw longer than this may cause electric shock or damage because it may contact with the electrical parts inside the monitor.
- Please check if the wall or ceiling can support the weight of the monitor before mounting it.

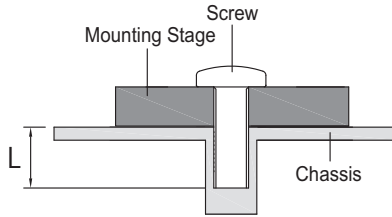

## FITTING AND REMOVAL OF BASE : ProLite XB2888HS

### CAUTION

- Put the monitor on a stable surface. The monitor may cause injury or damage if it falls or is dropped.
- Do not give a strong impact to the monitor. It may cause damage.
- Unplug the monitor before removal or installation to avoid electric shock or damage.

### <Installation>

- ① Put a piece of soft cloth on the table beforehand to prevent the monitor from being scratched.  
Lay the monitor flat on a table with front face down.
- ② Hold the monitor and push the Stand-Base.
- ③ Use 'thumb screw' provided to secure base to monitor column.

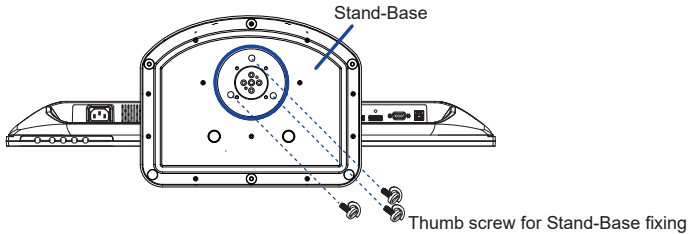

### <Removal>

- ① Put a piece of soft cloth on the table beforehand to prevent the monitor from being scratched.  
Lay the monitor flat on a table with front face down.
- ② Remove 'thumb screw' to remove base from monitor column.

### <Stopper>

Put the monitor on a flat surface. Press the stopper at the back of the stand while pushing the monitor from the top. Careful attention is required as the monitor is sprung loaded and the stand may expand quickly.

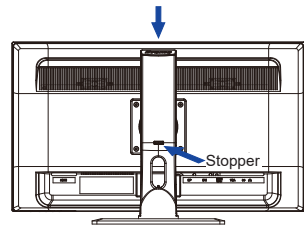

## FITTING AND REMOVAL OF BASE : ProLite X288HS

- CAUTION**
- Put the monitor on a stable surface. The monitor may cause injury or damage if it falls or is dropped.
  - Do not give a strong impact to the monitor. It may cause damage.
  - Unplug the monitor before removal or installation to avoid electric shock or damage.

### <Installation>

- ① Put a piece of soft cloth on the table beforehand to prevent the monitor from being scratched. Lay the monitor flat on a table with front face down.
- ② Hold the monitor and push the Stand-Base until it clicks and is secure.

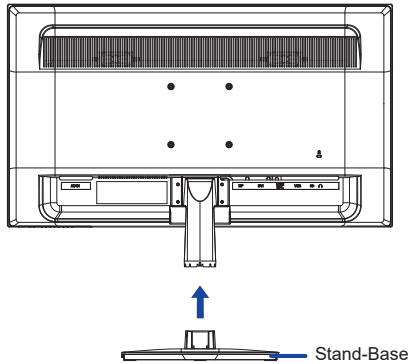

### <Removal>

- ① Put a piece of soft cloth on the table beforehand to prevent the monitor from being scratched. Lay the monitor flat on a table with front face down.
- ② Press and hold the hooks inside, and pull the Stand-Base.

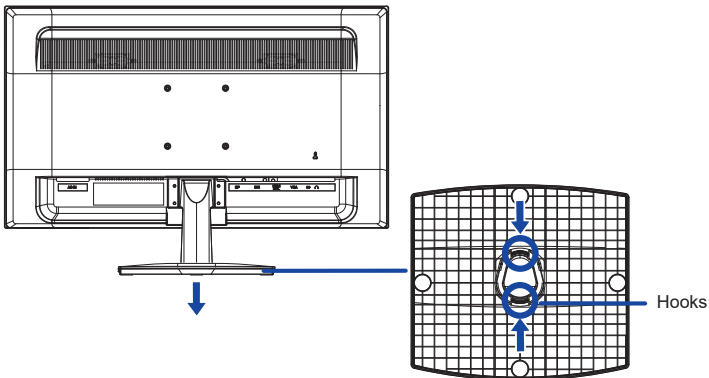

## CONTROLS AND CONNECTORS : ProLite XB288HS

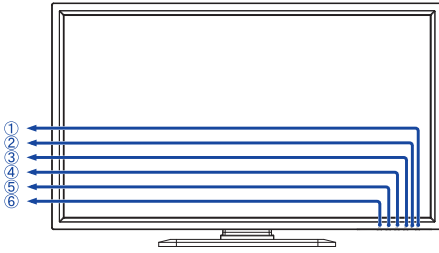

<Front>

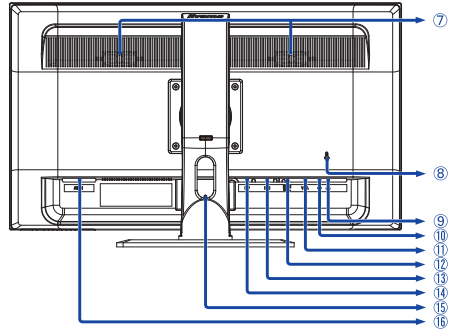

<Back>

① Power Switch (⏻)

② Power Indicator

**NOTE** Blue: Normal operation  
Orange: Power Management

③ Input / Select / Blue Light Reducer Button (Ⓚ)\*

④ Scroll up / Audio Adjust Button (▲)\*

⑤ Scroll down / i-Style Color Button (▼)\*

⑥ Menu Button (Ⓛ)

⑦ Speakers

⑧ Keyhole for Security Lock

**NOTE** You can fasten a security lock and cable to prevent the monitor from being removed without your permission.

⑨ Headphone Connector (🎧)

⑩ Audio Connector (AUDIO IN)

⑪ VGA(D-sub) mini 15pin Connector (VGA)

⑫ HDMI / MHL Connector (HDMI / MHL)

⑬ DVI-D 24pin Connector (DVI)

⑭ DisplayPort Connector (DP)





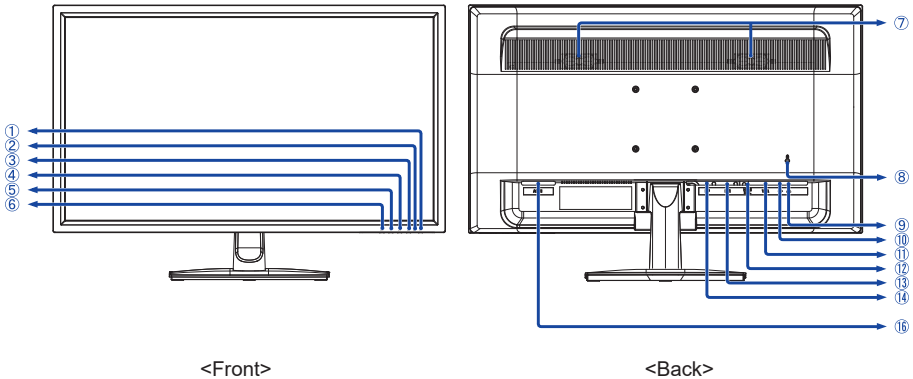

⑮ Cable Holes

⑯ AC Connector(⚡: Alternating current) (AC-IN)

\* You can skip the Menu items and display an adjustment scale directly.

## CONTROLS AND CONNECTORS : ProLite X288HS



- ① Power Switch (  )
- ② Power Indicator  
**NOTE** Blue: Normal operation  
Orange: Power Management
- ③ Input / Select / Blue Light Reducer Button (  )\*
- ④ Scroll up / Audio Adjust Button (  )\*
- ⑤ Scroll down / i-Style Color Button (  )\*
- ⑥ Menu Button (  )
- ⑦ Speakers
- ⑧ Keyhole for Security Lock  
**NOTE** You can fasten a security lock and cable to prevent the monitor from being removed without your permission.
- ⑨ Headphone Connector (  )
- ⑩ Audio Connector (AUDIO IN)
- ⑪ VGA(D-sub) mini 15pin Connector (VGA)
- ⑫ HDMI / MHL Connector (HDMI / MHL)
- ⑬ DVI-D 24pin Connector (DVI)
- ⑭ DisplayPort Connector (DP)
- ⑮ AC Connector( ~: Alternating current ) (AC-IN)

\* You can skip the Menu items and display an adjustment scale directly.

## CONNECTING YOUR MONITOR : ProLite XB288HS

- ① Ensure that both the computer and the monitor are switched off.
- ② Connect the computer to the monitor with the signal cable.
- ③ Connect the monitor to the audio equipment with the Audio Cable for computer when using the audio features.
- ④ Connect the Power Cable to the monitor first and then to the power supply.
- ⑤ Turn on your monitor and computer.

### NOTE

- The signal cables used for connecting the computer and monitor may vary with the type of computer used. An incorrect connection may cause serious damage to both the monitor and the computer. The cable supplied with the monitor is for a standard connector. If a special cable is required please contact your local iiyama dealer or regional iiyama office.
- For connection to Macintosh computers, contact your local iiyama dealer or regional iiyama office for a suitable adaptor.
- Make sure you tighten the finger screws at each end of the signal cable.

[Example of Connection]

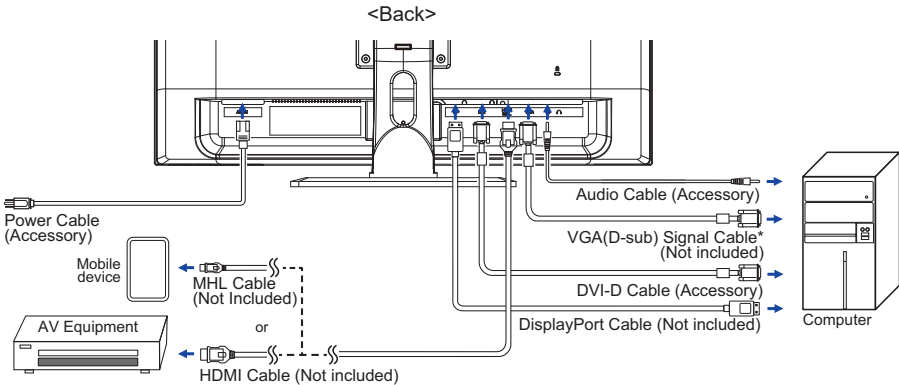

\* VGA (D-Sub) cable is not supplied with the monitor; you need to use a special VGA (D-Sub) cable dedicated for this model. Please contact the iiyama Support Centre in your country if you wish to connect the monitor via the VGA input.

### [ Collect Cables ]

- ① Put the cables through the cable hole.
- ② Collect cables at the back of the stand.

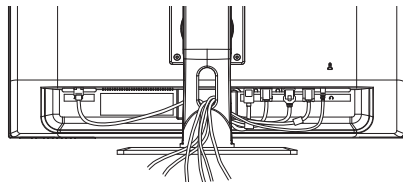

## CONNECTING YOUR MONITOR : ProLite X2888HS

- ① Ensure that both the computer and the monitor are switched off.
- ② Connect the computer to the monitor with the signal cable.
- ③ Connect the monitor to the audio equipment with the Audio Cable for computer when using the audio features.
- ④ Connect the Power Cable to the monitor first and then to the power supply.
- ⑤ Turn on your monitor and computer.

### NOTE

- The signal cables used for connecting the computer and monitor may vary with the type of computer used. An incorrect connection may cause serious damage to both the monitor and the computer. The cable supplied with the monitor is for a standard connector. If a special cable is required please contact your local iiyama dealer or regional iiyama office.
- For connection to Macintosh computers, contact your local iiyama dealer or regional iiyama office for a suitable adaptor.
- Make sure you tighten the finger screws at each end of the signal cable.

[Example of Connection]

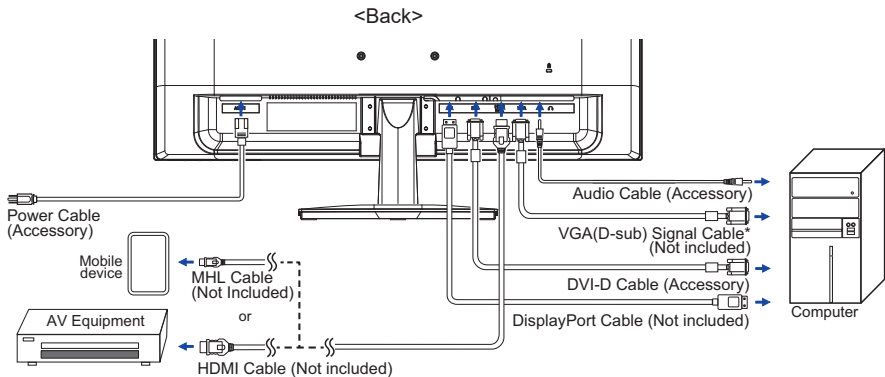

\* VGA (D-Sub) cable is not supplied with the monitor; you need to use a special VGA (D-Sub) cable dedicated for this model. Please contact the iiyama Support Centre in your country if you wish to connect the monitor via the VGA input.

## COMPUTER SETTING

### ■ Signal Timing

Change to the desired signal timing listed on page 31: COMPLIANT TIMING.

## ADJUSTING THE HEIGHT AND THE VIEWING ANGLE : ProLite XB2888HS

- For optimal viewing it is recommended to position yourself directly opposite to the full face of the monitor, then adjust the monitor's height and angle to your own preference.
- Hold the panel so that the monitor does not topple when you change the monitor's height or angle.
- You are able to adjust the monitor's height up to 130mm, angle up to 45 degrees right and left, 17 degrees upward.

### NOTE

- Do not touch the LCD screen when you change the height or the angle. It may cause damage or break the LCD screen.
- Careful attention is required not to catch your fingers or hands when you change the height or the angle.
- Injury can occur if care is not taken to avoid finger contact with the displays base when adjusting the height.

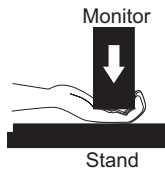
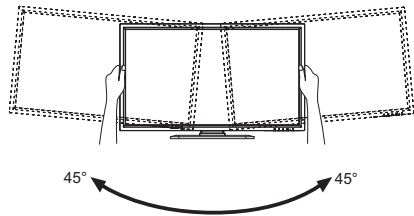
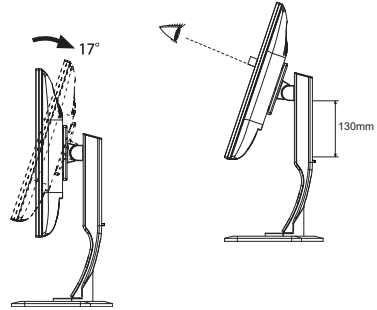



## ADJUSTING THE VIEWING ANGLE : ProLite X2888HS

- For optimal viewing it is recommended to look at the full face of the monitor.
- Hold the stand so that the monitor does not topple when you change the monitor's angle.
- You are able to adjust the monitor's angle up to 20° upward, 3° downward.
- In order to ensure a healthy and relaxed body position when using the monitor at visual display workstations, it is recommended that the adjusted tilt angle should not exceed 10 degrees. Adjust the monitor's angle to your own preference.

### NOTE

- Do not touch the LCD screen when you change the angle. It may cause damage or break the LCD screen.
- Careful attention is required not to catch your fingers or hands when you change the angle.

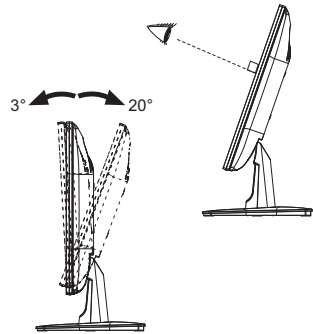

# OPERATING THE MONITOR

To create the best picture, your iiyama LCD monitor has been preset at the factory with the COMPLIANT TIMING shown on page 31. You are also able to adjust the picture by following the button operation shown below. For more detailed adjustments, see page 22 for SCREEN ADJUSTMENTS.

- 1 Press the 1 Button to start the On Screen Display (OSD) feature. There are additional Menu items which can be switched by using the ▲ / ▼ Buttons.

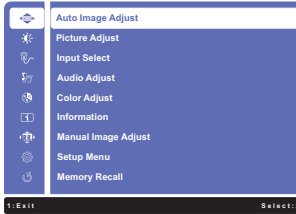

- 2 Select the Menu item which contains the adjustment icon relating to the adjustment you want to make. Press the 2 Button. Then, use the ▲ / ▼ Buttons to highlight the desired adjustment icon.
- 3 Press the 2 Button again. Use the ▲ / ▼ Buttons to make the appropriate adjustment or setting.
- 4 Press the 1 Button to leave the menu, and the settings you just made would be automatically saved.

For example, to correct for vertical position, select Menu item of Manual Image Adjust and then press the 2 Button. Then, select H./V.Position by using the ▲ / ▼ Buttons.

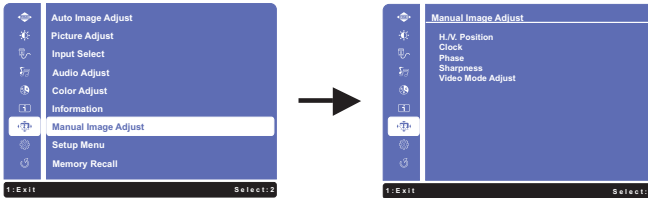

An adjustment page appears after you press the 2 Button. Then, select V. Position by using the ▲ / ▼ Buttons. Press the 2 Button again. Then, use the ▲ / ▼ Buttons to change the vertical position settings. The vertical position of the overall display should be changing accordingly while you are doing this.

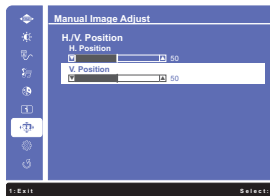

Press the 1 Button lastly, it ends, all changes are saved in the memory.

**NOTE**

- When button operations are aborted during adjustment, On-Screen Display disappears when the time set for the OSD Time Out has passed. Also, the 1 button can be used to return previous menu and turn off the On-Screen Display.
- Any changes are automatically saved in the memory when the On Screen Display disappears. Turning off the power should be avoided while using the Menu.
- Adjustments for H./V. Position, Clock and Phase are saved for each signal timing. Except for these adjustments, all other adjustments have only one setting which applies to all signal timings.

## ADJUSTMENT MENU CONTENTS













Auto Image Adjust		Auto Image Adjust
Only Analog Input		
Adjustment Item	Problem / Option	Button to Press
Auto Image Adjust * <b>Direct</b>	Adjust H. / V. Position, Clock and Phase automatically.	

\* For best results, use the Auto Image Adjust in conjunction with the adjustment pattern. See page 22 for SCREEN ADJUSTMENTS.

### Direct

You can skip the Menu items and display an adjustment scale directly by using the following button operations.

- Auto Image Adjust: Pressing and holding of the ▼ Button for about 2 seconds when the Menu is not displayed.

Picture Adjust		Picture Adjust	
Adjustment Item	Problem / Option		Button to Press
Contrast * <sup>3</sup>	Too dull		 
	Too intense		 
Brightness * <sup>1,2,3</sup>	Too dark		 
	Too bright		 
Adv. Contrast * <sup>2,3,4</sup>	Off	Typical Contrast Ratio	
	On	Increased Contrast Ratio	
ECO Mode * <sup>3</sup>	Off	Normal	
	1	Brightness of back-light is reduced.	
	2	Brightness of back-light is reduced more than 1.	
	3	Brightness of back-light is reduced more than 2.	
Overdrive	Off / -2 / -1 / 0 / +1 / +2		 
	It will improve the gray level response time of the LCD panel. A higher level results in a faster response time.		 

\*<sup>1</sup> Adjust the Brightness when you are using the monitor in a dark room and feel the screen is too bright. Can not select when Adv. Contrast is On.

\*<sup>2</sup> Brightness and Adv. Contrast can not enable the same time when ECO Mode is on.

\*<sup>3</sup> Contrast, Brightness, Adv. Contrast and ECO Mode adjustments are disabled when i-Style Color is activated.





\*<sup>4</sup> To activate the option, mark it in the setup menu. To deactivate it, remove the marking.

<b>Input Select</b>		<b>Direct</b>		<b>Input Select</b>
Adjustment Item	Problem / Option		Button to Press	
Input Select	VGA	Select the VGA input.		
	DVI	Select the DVI input.		
	HDMI/MHL	Select the HDMI/MHL input.		
	DisplayPort	Select the DisplayPort input.		
	Auto	Search for an available input source and select automatically.		
<b>NOTE</b> Input source is fixed, not selected automatically when VGA, DVI, HDMI/MHL and DisplayPort which are selected.				

**Direct**

You can skip the Menu items and display an adjustment scale directly by using the following button operations.

- Input Select: Press the  Button when the Menu is not displayed.



<b>Audio Adjust</b>		<b>Direct</b>		<b>Audio Adjust</b>
Adjustment Item	Problem / Option		Button to Press	
Volume	Too soft		 	
	Too loud		 	
Mute * <sup>1</sup>	<b>Direct</b>	Off	Return the sound volume to the previous level.	
		On	Turn off the sound temporarily.	
Audio Input * <sup>2</sup>	Line-In	Select the Line-In input.		
	HDMI/MHL	Select the HDMI/MHL input.		
	DisplayPort	Select the DisplayPort input.		

\*<sup>1</sup> To activate the option, mark it in the setup menu. To deactivate it, remove the marking.

\*<sup>2</sup> Suitable for HDMI/MHL and DisplayPort input only.

**Direct**

You can skip the Menu items and display an adjustment scale directly by using the following button operations.

- Audio Adjust: Press the  Button when the Menu is not displayed.
- Mute: Pressing and holding of the  Button for about 2 seconds when the Menu is not displayed.  
Mute and Unmute are switched as follows by pressing the  Button successively.

Color Adjust *		Color Adjust	
Adjustment Item	Problem / Option		Button to Press
sRGB	sRGB		
Adobe RGB	Adobe RGB		
Cool	Bluish white		
Normal	Greenish white		
Warm	Reddish white		
User Color	Red	Too weak	← ▲
	Green	Too strong	→ ▼
	Blue		
i-Style Color <b>Direct</b>	Off	Return to a state set by color adjustment except i-Style Color.	
	Standard	For general windows environment and monitor default setting.	
	Game	For PC game environment.	
	Cinema	For movie and video environment.	
	Scenery	For displaying outdoor scenery images	
	Text	For text editing and viewing in a word processing environment.	









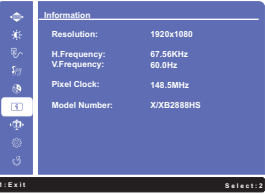











\* Color Adjust is disabled when Blue Light Reducer is activated.

**Direct**

You can skip the Menu items and display an adjustment scale directly by using the following button operations.

- i-Style Color: Press the ▼ Button when the Menu is not displayed.

Information		Information	
<p>&lt;Example&gt;</p> 			
<p>Displays information regarding the current input signal coming from the graphic card in your computer.</p>		<p><b>NOTE</b> See your graphic card user guide for more information about changing the resolution and refresh.</p>	

Manual Image Adjust		Manual Image Adjust	
Adjustment Item	Problem / Option		Button to Press
H./V. Position *1,2	H. Position	 Too left	 
		 Too right	 
Clock *1		 Too narrow	 
		 Too wide	 
Phase *1	To correct flickering text or lines		  
Sharpness	0 1 2 3 You can change the picture quality from 0 to 3 (soft to sharp). Press the  Button to change the picture quality in numerical order. Press the  Button to change the picture quality in reverse numerical order. Adjust the picture quality at resolutions of less 1920 x 1080. You can change the picture quality (4 steps).		   
Video Mode Adjust	Aspect Ratio *3	Expansion display of Aspect	
	Full Screen	Full screen display	
	Dot by Dot	Display the picture dot by dot.	
Blue Light Reducer *4 <b>Direct</b>	Off	Typical	
	1	Blue light is reduced.	
	2	Blue light is reduced more than Mode1.	
	3	Blue light is reduced more than Mode2.	
X-Res Technology	Off	Normal	
	Soft	Enhance the picture edge.	
	Middle	Enhance the picture edge more than the Soft option.	
	Hard	Enhance the picture edge more than the Middle option.	

\*1 Only Analog Input.

\*2 See page 22 for SCREEN ADJUSTMENTS.







\*3 It can display in the center of the screen with a 4:3, 5:4 or 16:10 aspect ratio when input video resolution is 4:3, 5:4 or 16:10.

\*4 Blue Light Reducer is disabled when Color Adjust is activated.

## Direct

You can skip the Menu items and display an adjustment scale directly by using the following button operations.

- Blue Light Reducer: Pressing and holding of the  Button for about 2 seconds when the Menu is not displayed.

Setup Menu		Setup Menu	
Adjustment Item	Problem / Option		Button to Press
Language Select	English	English	Русский Russian
	Français	French	日本語 Japanese
	Deutsch	German	简体中文 Simplified Chinese
	Nederlands	Dutch	繁體中文 Traditional Chinese
	Polski	Polish	
OSD Position	H.Position	OSD is too left	
		OSD is too right	
	V.Position	OSD is too low	
		OSD is too high	
OSD Time Out	You can set the OSD display duration time. 5 / 15 / 30 / 60 seconds		  
OSD Background*	Off	Retune the background of OSD.	
	On	The background of OSD is mode transparent.	
Opening Logo*	Off	iiyama Logo does not display when the monitor is turned on.	
	On	iiyama Logo displayed when the monitor is turned on.	
LED*	Off	The Power Indicator is turned Off.	
	On	The Power Indicator is turned On.	
<b>NOTE</b> Turn Off the Power Indicator when you are bothered by the light.			

\* To activate the option, mark it in the setup menu. To deactivate it, remove the marking.

Memory Recall		Memory Recall	
Adjustment Item	Problem / Option		Button to Press
Memory Recall	Factory-preset data is restored.		



## ● Lock Mode

### <OSD Menu>

1. The OSD lock will be activated by pressing the front buttons ① and ▲ for about 5 seconds. If you try to access the OSD by pressing any of the buttons ①, ▼, ▲ and ②, message "OSD Locked" will appear on the screen.
2. The OSD lock will be deactivated by pressing the front buttons ① and ▲ again for 5 seconds.

### <Power Switch>

1. The power switch lock will be activated by pressing the front buttons ① and ▼ for 10 seconds. Locking the power switch means that won't be able to turn off the Monitor while the power switch is locked. If presses the power switch message "Power Button Locked" will appear on the screen.
2. The power switch lock will be deactivated by pressing the front buttons ① and ▼ again for about 10 seconds.

## SCREEN ADJUSTMENTS

Adjust the image by following the procedure below to get the desired picture when selecting Analog input.

- The screen adjustments described in this manual are designed to set image position and minimize flicker or blur for the particular computer in use.
- The monitor is designed to provide the best performance at resolution of 1920 × 1080, but can not provide the best at resolutions of less than 1920 × 1080 because the picture is automatically stretched to fit the full screen. It is recommended to operate at resolution of 1920 × 1080 in normal use.
- Displayed text or lines will be blurred or irregular in thickness when the picture is stretched due to the screen enlargement process.
- It is preferable to adjust the image position and frequency with the monitor controls, rather than the computer software or utilities.
- Perform adjustments after a warm-up period of at least thirty minutes.
- Additional adjustments may be required after the Auto Image Adjust depending on the resolution or signal timing.
- The Auto Image Adjust may not work correctly when displaying the picture other than the screen adjustment pattern. In this case, manual adjustments are required.

There are two ways to adjust the screen. One way is automatic adjustment for Position, Clock and Phase. The other way is performing each adjustment manually.

Perform the Auto Image Adjust first when the monitor is connected to a new computer, or resolution is changed. If the screen has a flicker or blur, or the picture does not fit in the display area after performing the Auto Image Adjust, manual adjustments are required. Both adjustments should be made by using the screen adjustment pattern (Test.bmp) obtained via the IIYAMA web site (<http://www.iiyama.com>).

Adjust the image by following the procedure below to get the desired picture.

This manual explains adjustment under Windows® OS.

- ① **Display the picture at the optimum resolution.**
- ② **Enter the Test.bmp (screen adjustment pattern) to wallpaper.**

### NOTE

- Consult the appropriate documentation for doing this.
- Test.bmp is made at resolution of 1280 × 1024. Set the display position to center in the wallpaper setting dialogue box.

[Adjustment pattern]

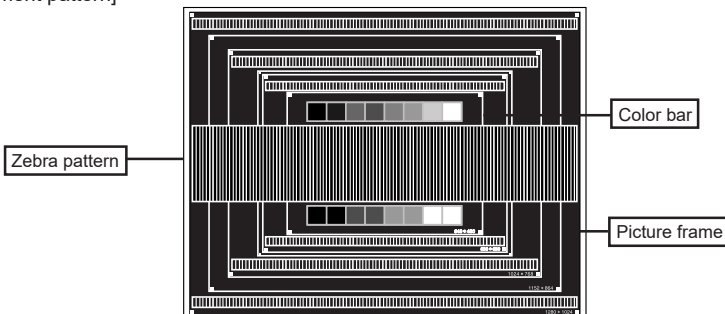

- ③ Pressing and holding of the ▼ Button for about 2 seconds. (Auto Image Adjust)
- ④ Adjust the image manually by following procedure below when the screen has a flicker or blur, or the picture does not fit in the display area after performing the Auto Image Adjust.
- ⑤ Adjust the V.Position so that the top and bottom of the picture frame will fit to the display area.

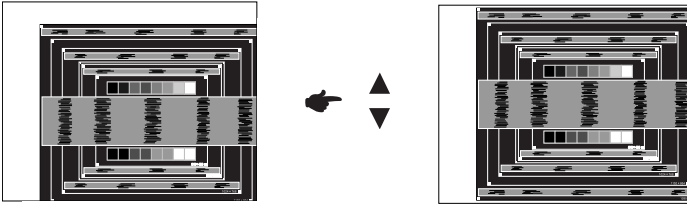

- ⑥ 1) Adjust the H.Position so that the left side of the picture frame will move to the left edge of the display area.

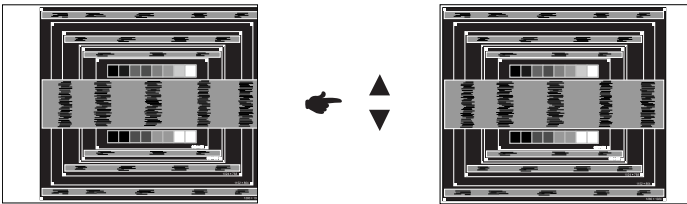

- 2) Stretch the right side of the picture frame to the right edge of the display area by adjusting the Clock.

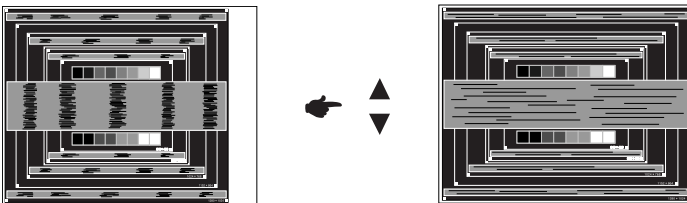
**NOTE**

- When the left side of the picture frame moves apart from the left edge of the display area during the Clock adjustment, adjust steps 1) and 2).
- Another way to make the Clock adjustment is to correct the vertical wavy lines in the zebra pattern.
- The picture may flicker during the Clock, H.Position and V.Position adjustment.
- In case the picture frame is bigger or smaller than the data display area after the Clock adjustment, repeat steps from ③.

- ⑦ Adjust the Phase to correct horizontal wavy noise, flicker or blur in the zebra pattern.

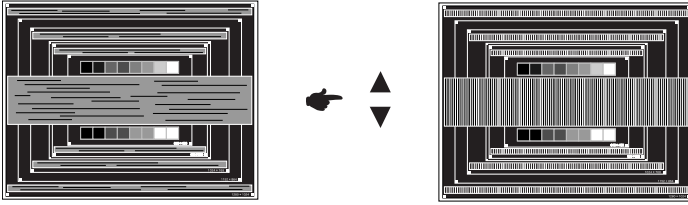
**NOTE**

- In case the strong flicker or blurs remain on a part of the screen, repeat steps ⑥ and ⑦ because the Clock may not be adjusted correctly. If the flicker or blurs still remain, set the refresh rate of computer to low (60Hz) and repeat steps from ③ again.
- Adjust the H.Position after the Phase adjustment if the horizontal position moves during the adjustment.

- ⑧ Adjust the Brightness and Color to get the desired picture after you complete the Clock and Phase adjustments.

Put back your favorite wallpaper.

## POWER MANAGEMENT FEATURE

The power management feature of this product complies with power saving requirement of VESA DPMS. When activated, it automatically reduces unnecessary power consumption of the monitor when your computer is not in use.

To use the feature, the monitor needs to be connected to a VESA DPMS compliant computer. There is a power management step the monitor takes as described below. The power management function, including any timer settings is configured by the operating system. Check your operating system manual for information on how this can be configured.

### ■ Power Management Mode

When the H-sync signal / V-sync signal / H and V sync signals from the computer are off, the monitor enters into Power Management Mode which reduces the power consumption to less than 0.5W. The screen becomes dark, and the power indicator turns to orange. From Power Management Mode, the image reappears in several seconds when either the keyboard or the mouse are touched again.

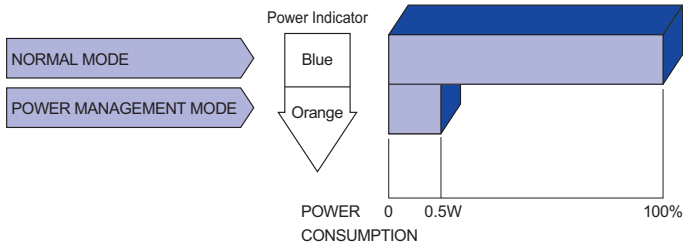

### NOTE

- Even when using the power management mode, the monitor consumes electricity. Turn off the Power Switch whenever the monitor is not in use, during the night and weekends, to avoid unnecessary power consumption.
- It is possible that the video signal from the computer may be on while the H or V sync signal is missing. In this instance, the POWER MANAGEMENT feature may not work properly.

## TROUBLE SHOOTING

If the monitor fails to operate correctly, please follow the steps below for a possible solution.

1. Perform the adjustments described in OPERATING THE MONITOR, depending on the problem you have. If the monitor does not get a picture, skip to 2.
2. Consult the following items if you cannot find an appropriate adjustment item in OPERATING THE MONITOR or if the problem persists.
3. If you are experiencing a problem which is not described below or you cannot correct the problem, discontinue using the monitor and contact your dealer or iiyama service center for further assistance.

<b>Problem</b>	<b>Check</b>
① The picture does not appear. (Power indicator does not light up.)  (Power indicator is blue.)	<input type="checkbox"/> The Power Cable is firmly seated in the socket. <input type="checkbox"/> The Power Switch is turned ON. <input type="checkbox"/> The AC socket is live. Please check with another piece of equipment. <input type="checkbox"/> If the blank screen saver is in active mode, touch the keyboard or the mouse. <input type="checkbox"/> Increase the Contrast and/or Brightness. <input type="checkbox"/> The computer is ON. <input type="checkbox"/> The Signal Cable is properly connected. <input type="checkbox"/> The signal timing of the computer is within the specification of the monitor.
(Power indicator is orange.)	<input type="checkbox"/> If the monitor is in power management mode, touch the keyboard or the mouse. <input type="checkbox"/> The computer is ON. <input type="checkbox"/> The Signal Cable is properly connected. <input type="checkbox"/> The signal timing of the computer is within the specification of the monitor.
② The screen is not synchronized.	<input type="checkbox"/> The Signal Cable is properly connected. <input type="checkbox"/> The signal timing of the computer is within the specification of the monitor. <input type="checkbox"/> The video output level of the computer is within the specification of the monitor.
③ The screen position is not in the center.	<input type="checkbox"/> The signal timing of the computer is within the specification of the monitor.
④ The screen is too bright or too dark.	<input type="checkbox"/> The video output level of the computer is within the specification of the monitor.
⑤ The screen is shaking.	<input type="checkbox"/> The power voltage is within the specification of the monitor. <input type="checkbox"/> The signal timing of the computer is within the specification of the monitor.

**Problem****Check**

- |                                       |  |
|---------------------------------------|--|
| ⑥ No sound.                           | <input type="checkbox"/> The audio equipment (computer etc.) is ON.  |
|                                       | <input type="checkbox"/> The Audio Cable is properly connected.  |
|                                       | <input type="checkbox"/> The Volume is turned up.  |
|                                       | <input type="checkbox"/> The Mute is OFF.  |
|                                       | <input type="checkbox"/> The audio output level of the audio equipment is within the specification of the monitor. |
| ⑦ The sound is too loud or too quiet. | <input type="checkbox"/> The audio output level of the audio equipment is within the specification of the monitor. |
| ⑧ A strange noise is heard.           | <input type="checkbox"/> The Audio Cable is properly connected.  |

## RECYCLING INFORMATION

For better environment protection please don't dispose your monitor.  
Please visit our web site: [www.iiyama.com/recycle](http://www.iiyama.com/recycle) for monitor recycling.

# APPENDIX

Design and specifications are subject to change without prior notice.

## SPECIFICATIONS : ProLite XB2888HS

ENGLISH

Size Category		28"
LCD Panel	Panel technology	VA
	Size	Diagonal: 28" (71cm)
	Pixel pitch	0.32mm H × 0.32mm V
	Brightness	300cd/m <sup>2</sup> (Typical)
	Contrast ratio	3000 : 1 (Typical), Adv. Contrast Function Available
	Viewable angle	Right / Left : 89 degrees each, Up / Down: 89 degrees each (Typical)
	Response time	5ms (Gray to Gray)
Display Colors		16,777,216
Sync Frequency		VGA: Horizontal: 30.0-80.0kHz, Vertical: 55-75Hz DVI: Horizontal: 30.0-80.0kHz, Vertical: 55-75Hz HDMI: Horizontal: 30.0-80.0kHz, Vertical: 55-75Hz DisplayPort: Horizontal: 30.0-80.0kHz, Vertical: 55-75Hz
Native Resolution		1920 × 1080, 2.1 MegaPixels
Supported max. resolution		VGA: 1920 × 1080 60Hz DVI: 1920 × 1080 60Hz HDMI: 1920 × 1080 60Hz MHL: 1080p DisplayPort: 1920 × 1080 60Hz
Input Connector		VGA(D-sub) mini 15 pin, DVI-D 24 pin, HDMI, DisplayPort
Plug & Play		VESA DDC2B™
Input Sync Signal		Separate sync: TTL, Positive or Negative
Input Video Signal		Analog: 0.7Vp-p (Standard), 75Ω, Positive Digital: DVI (Digital Visual Interface Standard Rev.1.0) compliance Digital: HDMI (MHL compliance), DisplayPort
Input Audio Connector		ø 3.5mm mini jack (Stereo)
Input Audio Signal		1.0Vrms maximum
Headphone Connector		ø 3.5mm mini jack (Stereo)
Speakers		3W × 2 (Stereo speakers)
Maximum Screen Size		620.9mm W × 341.2mm H / 24.4" W × 13.4" H
Power Source		100-240VAC, 50/60Hz, 1.0A
Power Consumption*		30W typical, Power management mode: 0.5W maximum Energy Efficiency Class: B
Dimensions / Net Weight		663.0 × 413.5 - 543.5 × 230.0mm / 26.1 × 16.3 - 21.4 × 9.1" (W×H×D) 7.3kg / 16.1lbs
Tilt Angle		Upward: 17 degrees, Left/Right: 45 degrees each
Environmental Considerations		Operating: Temperature 5 to 35°C / 41 to 95°F Humidity 10 to 80% (No condensation) Storage: Temperature -20 to 60°C / -4 to 140°F Humidity 5 to 85% (No condensation)
Approvals		CE, TÜV-Bauart, CU, VCCI-B, PSE

**NOTE** \* MHL and Audio equipment are not connected.



## SPECIFICATIONS : ProLite X2888HS

Size Category	28"	
LCD Panel	Panel technology	VA
	Size	Diagonal: 28" (71cm)
	Pixel pitch	0.32mm H × 0.32mm V
	Brightness	300cd/m <sup>2</sup> (Typical)
	Contrast ratio	3000 : 1 (Typical), Adv. Contrast Function Available
	Viewable angle	Right / Left : 89 degrees each, Up / Down: 89 degrees each (Typical)
	Response time	5ms (Gray to Gray)
Display Colors	16,777,216	
Sync Frequency	VGA: Horizontal: 30.0-80.0kHz, Vertical: 55-75Hz DVI: Horizontal: 30.0-80.0kHz, Vertical: 55-75Hz HDMI: Horizontal: 30.0-80.0kHz, Vertical: 55-75Hz DisplayPort: Horizontal: 30.0-80.0kHz, Vertical: 55-75Hz	
Native Resolution	1920 × 1080, 2.1 MegaPixels	
Supported max. resolution	VGA: 1920 × 1080 60Hz DVI: 1920 × 1080 60Hz HDMI: 1920 × 1080 60Hz MHL: 1080p DisplayPort: 1920 × 1080 60Hz	
Input Connector	VGA(D-sub) mini 15 pin, DVI-D 24 pin, HDMI, DisplayPort	
Plug & Play	VESA DDC2B™	
Input Sync Signal	Separate sync: TTL, Positive or Negative	
Input Video Signal	Analog: 0.7Vp-p (Standard), 75Ω, Positive Digital: DVI (Digital Visual Interface Standard Rev.1.0) compliance Digital: HDMI (MHL compliance), DisplayPort	
Input Audio Connector	ø 3.5mm mini jack (Stereo)	
Input Audio Signal	1.0Vrms maximum	
Headphone Connector	ø 3.5mm mini jack (Stereo)	
Speakers	3W × 2 (Stereo speakers)	
Maximum Screen Size	620.9mm W × 341.2mm H / 24.4" W × 13.4" H	
Power Source	100-240VAC, 50/60Hz, 1.0A	
Power Consumption*	30W typical, Power management mode: 0.5W maximum Energy Efficiency Class: B	
Dimensions / Net Weight	663.0 × 463.5 × 242.0mm / 26.1 × 18.2 × 9.5" (W×H×D) 5.4kg / 11.9lbs	
Tilt Angle	Upward: 20 degrees Downward: 3 degrees	
Environmental Considerations	Operating: Temperature 5 to 35°C / 41 to 95°F Humidity 10 to 80% (No condensation) Storage: Temperature -20 to 60°C / -4 to 140°F Humidity 5 to 85% (No condensation)	
Approvals	CE, TÜV-Bauart, CU, VCCI-B, PSE	

**NOTE** \* MHL and Audio equipment are not connected.

**DIMENSIONS : ProLite XB288HS**

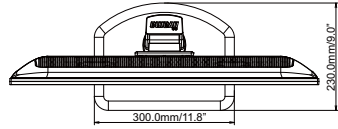
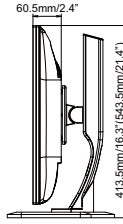
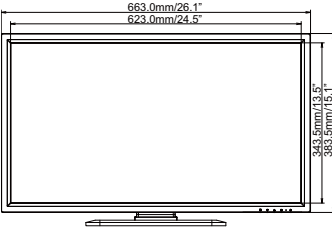

( ) : Maximum adjustment range

**DIMENSIONS : ProLite X288HS**

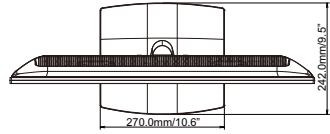
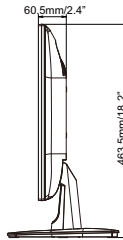
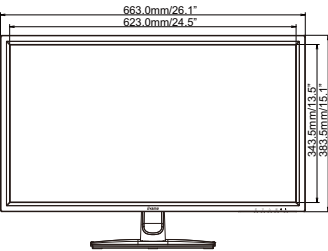

## COMPLIANT TIMING

Video Mode			Horizontal Frequency	Vertical Frequency	Dot Clock
VESA	VGA	640 × 480	31.469kHz	59.940Hz	25.175MHz
			37.500kHz	75.000Hz	31.500MHz
			37.861kHz	72.809Hz	31.500MHz
	SVGA	800 × 600	35.156kHz	56.250Hz	36.000MHz
			37.879kHz	60.317Hz	40.000MHz
			46.875kHz	75.000Hz	49.500MHz
	XGA	1024 × 768	48.363kHz	60.004Hz	65.000MHz
			56.476kHz	70.069Hz	75.000MHz
			60.023kHz	75.029Hz	78.750MHz
	SXGA	1280 × 1024	63.981kHz	60.020Hz	108.000MHz
			79.976kHz	75.025Hz	135.000MHz
			55.935kHz	59.887Hz	106.500MHz
	WXGA+	1440 × 900	70.635kHz	74.984Hz	136.750MHz
			65.290kHz	60.000Hz	146.250MHz
WSXGA+	1680 × 1050	65.290kHz	60.000Hz	146.250MHz	
Full HD	1920 × 1080	66.590kHz	59.930Hz	138.500MHz	