

# Vostro 14 5415

## Service Manual

## Notes, cautions, and warnings

 **NOTE:** A NOTE indicates important information that helps you make better use of your product.

 **CAUTION:** A CAUTION indicates either potential damage to hardware or loss of data and tells you how to avoid the problem.

 **WARNING:** A WARNING indicates a potential for property damage, personal injury, or death.

<b>Chapter 1: Working inside your computer</b> .....	<b>6</b>
Before working inside your computer.....	6
Safety instructions.....	6
Radiation Exposure Statement .....	7
Electrostatic discharge—ESD protection.....	7
ESD field service kit .....	8
Transporting sensitive components.....	9
After working inside your computer.....	9
<b>Chapter 2: Removing and installing components</b> .....	<b>10</b>
Recommended tools.....	10
Screw list.....	10
Major components of Vostro 14 5415.....	11
Base cover.....	13
Removing the base cover.....	13
Installing the base cover.....	14
Battery.....	16
Lithium-ion battery precautions.....	16
Removing the 3-cell battery.....	16
Installing the 3-cell battery.....	17
Removing the 4-cell battery.....	18
Installing the 4-cell battery.....	19
Memory module.....	20
Removing the memory.....	20
Installing the memory.....	21
Solid-state drive.....	23
Removing the M.2 2230 solid-state drive.....	23
Installing the M.2 2230 solid-state drive.....	23
Removing the M.2 2280 solid-state drive.....	24
Installing the M.2 2280 solid-state drive.....	25
Installing the solid-state drive mounting bracket.....	26
Wireless card.....	28
Removing the wireless card.....	28
Installing the wireless card.....	29
Fan.....	30
Removing the fan.....	30
Installing the fan.....	31
Coin-cell battery.....	31
Removing the coin-cell battery.....	31
Installing the coin-cell battery.....	32
Heat sink.....	33
Removing the heat sink.....	33
Installing the heat sink.....	34
Network-port bracket.....	35

Removing the network-port bracket.....	35
Installing the network-port bracket.....	36
I/O board.....	37
Removing the I/O board.....	37
Installing the I/O board.....	38
Speakers.....	39
Removing the speakers.....	39
Installing the speakers.....	41
Touchpad.....	42
Removing the touchpad.....	42
Installing the touchpad.....	43
Display assembly.....	44
Removing the display assembly.....	44
Installing the display assembly.....	46
Power button with optional fingerprint reader.....	48
Removing the power-button with optional fingerprint reader.....	48
Installing the power-button with optional fingerprint reader.....	49
Power-adapter port.....	50
Removing the power-adapter port.....	50
Installing the power-adapter port.....	50
System board.....	51
Removing the system board.....	51
Installing the system board.....	54
Palm-rest and keyboard assembly.....	57
Removing the palm-rest and keyboard assembly.....	57
Installing the palm-rest and keyboard assembly.....	58
<b>Chapter 3: Drivers and downloads.....</b>	<b>60</b>
<b>Chapter 4: System setup.....</b>	<b>61</b>
BIOS overview.....	61
Entering BIOS setup program.....	61
Navigation keys.....	61
Boot Sequence.....	62
System setup options.....	62
System and admin password.....	67
Assigning a system setup password.....	67
Deleting or changing an existing system setup password.....	68
Clearing BIOS (System Setup) and System passwords.....	68
<b>Chapter 5: Troubleshooting.....</b>	<b>69</b>
Dell SupportAssist Pre-boot System Performance Check diagnostics.....	69
Running the SupportAssist Pre-Boot System Performance Check.....	69
System diagnostic lights.....	70
Recovering the operating system.....	71
Flashing BIOS (USB key).....	71
Flashing the BIOS.....	71
M-BIST.....	72
LCD Built-in Self Test (BIST).....	72

WiFi power cycle.....	72
Flea power release.....	73
<b>Chapter 6: Getting help and contacting Dell.....</b>	<b>74</b>
Contacting Dell.....	75

# Working inside your computer

## Topics:



- Before working inside your computer
- Safety instructions
- Electrostatic discharge—ESD protection
- ESD field service kit
- Transporting sensitive components
- After working inside your computer

## Before working inside your computer

### About this task

 **NOTE:** The images in this document may differ from your computer depending on the configuration you ordered.

### Steps

1. Save and close all open files and exit all open applications.
2. Shut down your computer. Click **Start** >  **Power** > **Shut down**.  
 **NOTE:** If you are using a different operating system, see the documentation of your operating system for shut-down instructions.
3. Disconnect your computer and all attached devices from their electrical outlets.
4. Disconnect all attached network devices and peripherals, such as keyboard, mouse, and monitor from your computer.  
 **CAUTION:** To disconnect a network cable, first unplug the cable from your computer and then unplug the cable from the network device.
5. Remove any media card and optical disc from your computer, if applicable.

## Safety instructions

Use the following safety guidelines to protect your computer from potential damage and to ensure your personal safety. Unless otherwise noted, each procedure included in this document assumes that you have read the safety information that shipped with your computer.

 **WARNING:** Before working inside your computer, read the safety information that is shipped with your computer. For more safety best practices, see the Regulatory Compliance home page at [www.dell.com/regulatory\\_compliance](http://www.dell.com/regulatory_compliance).

 **WARNING:** Disconnect your computer from all power sources before opening the computer cover or panels. After you finish working inside the computer, replace all covers, panels, and screws before connecting your computer to an electrical outlet.

 **CAUTION:** To avoid damaging the computer, ensure that the work surface is flat, dry, and clean.

 **CAUTION:** To avoid damaging the components and cards, handle them by their edges, and avoid touching the pins and the contacts.

**CAUTION:** You should only perform troubleshooting and repairs as authorized or directed by the Dell technical assistance team. Damage due to servicing that is not authorized by Dell is not covered by your warranty. See the safety instructions that is shipped with the product or at [www.dell.com/regulatory\\_compliance](http://www.dell.com/regulatory_compliance).

**CAUTION:** Before touching anything inside your computer, ground yourself by touching an unpainted metal surface, such as the metal at the back of the computer. While you work, periodically touch an unpainted metal surface to dissipate static electricity which could harm internal components.

**CAUTION:** When you disconnect a cable, pull it by its connector or its pull tab, not the cable itself. Some cables have connectors with locking tabs or thumbscrews that you must disengage before disconnecting the cable. When disconnecting cables, keep them evenly aligned to avoid bending the connector pins. When connecting cables, ensure that the ports and the connectors are correctly oriented and aligned.

**CAUTION:** Press and eject any installed card from the media-card reader.

**NOTE:** The color of your computer and certain components may appear differently than shown in this document.

## Radiation Exposure Statement

This device meets the government's requirements for exposure to radio waves. This device is designed and manufactured not to exceed the emission limits for exposure to radio frequency (RF) energy set by the Federal Communications Commission of the U.S. Government.

The exposure standard for wireless device employs a unit of measurement known as the Specific Absorption Rate, or SAR. The SAR limit set by the FCC is 1,6 W/kg.

**NOTE:** Tests for SAR are conducted using standard operating positions accepted by the FCC with the device transmitting at its highest certified power level in all tested frequency bands.

## Electrostatic discharge—ESD protection

ESD is a major concern when you handle electronic components, especially sensitive components such as expansion cards, processors, memory DIMMs, and system boards. Very slight charges can damage circuits in ways that may not be obvious, such as intermittent problems or a shortened product life span. As the industry pushes for lower power requirements and increased density, ESD protection is an increasing concern.

Due to the increased density of semiconductors used in recent Dell products, the sensitivity to static damage is now higher than in previous Dell products. For this reason, some previously approved methods of handling parts are no longer applicable.

Two recognized types of ESD damage are catastrophic and intermittent failures.

- **Catastrophic** – Catastrophic failures represent approximately 20 percent of ESD-related failures. The damage causes an immediate and complete loss of device functionality. An example of catastrophic failure is a memory DIMM that has received a static shock and immediately generates a "No POST/No Video" symptom with a beep code emitted for missing or nonfunctional memory.
- **Intermittent** – Intermittent failures represent approximately 80 percent of ESD-related failures. The high rate of intermittent failures means that most of the time when damage occurs, it is not immediately recognizable. The DIMM receives a static shock, but the tracing is merely weakened and does not immediately produce outward symptoms related to the damage. The weakened trace may take weeks or months to melt, and in the meantime may cause degradation of memory integrity, intermittent memory errors, etc.

The more difficult type of damage to recognize and troubleshoot is the intermittent (also called latent or "walking wounded") failure.

Perform the following steps to prevent ESD damage:

- Use a wired ESD wrist strap that is properly grounded. The use of wireless anti-static straps is no longer allowed; they do not provide adequate protection. Touching the chassis before handling parts does not ensure adequate ESD protection on parts with increased sensitivity to ESD damage.
- Handle all static-sensitive components in a static-safe area. If possible, use anti-static floor pads and workbench pads.
- When unpacking a static-sensitive component from its shipping carton, do not remove the component from the anti-static packing material until you are ready to install the component. Before unwrapping the anti-static packaging, ensure that you discharge static electricity from your body.

- Before transporting a static-sensitive component, place it in an anti-static container or packaging.

## ESD field service kit

The unmonitored Field Service kit is the most commonly used service kit. Each Field Service kit includes three main components: anti-static mat, wrist strap, and bonding wire.

### Components of an ESD field service kit

The components of an ESD field service kit are:

- **Anti-Static Mat** – The anti-static mat is dissipative and parts can be placed on it during service procedures. When using an anti-static mat, your wrist strap should be snug and the bonding wire should be connected to the mat and to any bare metal on the system being worked on. Once deployed properly, service parts can be removed from the ESD bag and placed directly on the mat. ESD-sensitive items are safe in your hand, on the ESD mat, in the system, or inside a bag.
- **Wrist Strap and Bonding Wire** – The wrist strap and bonding wire can be either directly connected between your wrist and bare metal on the hardware if the ESD mat is not required, or connected to the anti-static mat to protect hardware that is temporarily placed on the mat. The physical connection of the wrist strap and bonding wire between your skin, the ESD mat, and the hardware is known as bonding. Use only Field Service kits with a wrist strap, mat, and bonding wire. Never use wireless wrist straps. Always be aware that the internal wires of a wrist strap are prone to damage from normal wear and tear, and must be checked regularly with a wrist strap tester in order to avoid accidental ESD hardware damage. It is recommended to test the wrist strap and bonding wire at least once per week.
- **ESD Wrist Strap Tester** – The wires inside of an ESD strap are prone to damage over time. When using an unmonitored kit, it is a best practice to regularly test the strap prior to each service call, and at a minimum, test once per week. A wrist strap tester is the best method for doing this test. If you do not have your own wrist strap tester, check with your regional office to find out if they have one. To perform the test, plug the wrist-strap's bonding-wire into the tester while it is strapped to your wrist and push the button to test. A green LED is lit if the test is successful; a red LED is lit and an alarm sounds if the test fails.
- **Insulator Elements** – It is critical to keep ESD sensitive devices, such as plastic heat sink casings, away from internal parts that are insulators and often highly charged.
- **Working Environment** – Before deploying the ESD Field Service kit, assess the situation at the customer location. For example, deploying the kit for a server environment is different than for a desktop or portable environment. Servers are typically installed in a rack within a data center; desktops or portables are typically placed on office desks or cubicles. Always look for a large open flat work area that is free of clutter and large enough to deploy the ESD kit with additional space to accommodate the type of system that is being repaired. The workspace should also be free of insulators that can cause an ESD event. On the work area, insulators such as Styrofoam and other plastics should always be moved at least 12 inches or 30 centimeters away from sensitive parts before physically handling any hardware components
- **ESD Packaging** – All ESD-sensitive devices must be shipped and received in static-safe packaging. Metal, static-shielded bags are preferred. However, you should always return the damaged part using the same ESD bag and packaging that the new part arrived in. The ESD bag should be folded over and taped shut and all the same foam packing material should be used in the original box that the new part arrived in. ESD-sensitive devices should be removed from packaging only at an ESD-protected work surface, and parts should never be placed on top of the ESD bag because only the inside of the bag is shielded. Always place parts in your hand, on the ESD mat, in the system, or inside an anti-static bag.
- **Transporting Sensitive Components** – When transporting ESD sensitive components such as replacement parts or parts to be returned to Dell, it is critical to place these parts in anti-static bags for safe transport.

### ESD protection summary

It is recommended that all field service technicians use the traditional wired ESD grounding wrist strap and protective anti-static mat at all times when servicing Dell products. In addition, it is critical that technicians keep sensitive parts separate from all insulator parts while performing service and that they use anti-static bags for transporting sensitive components.



# Transporting sensitive components

When transporting ESD sensitive components such as replacement parts or parts to be returned to Dell, it is critical to place these parts in anti-static bags for safe transport.

## Lifting equipment

Adhere to the following guidelines when lifting heavy weight equipment:

 **CAUTION: Do not lift greater than 50 pounds. Always obtain additional resources or use a mechanical lifting device.**

1. Get a firm balanced footing. Keep your feet apart for a stable base, and point your toes out.
2. Tighten stomach muscles. Abdominal muscles support your spine when you lift, offsetting the force of the load.
3. Lift with your legs, not your back.
4. Keep the load close. The closer it is to your spine, the less force it exerts on your back.
5. Keep your back upright, whether lifting or setting down the load. Do not add the weight of your body to the load. Avoid twisting your body and back.
6. Follow the same techniques in reverse to set the load down.

## After working inside your computer

### About this task

 **CAUTION: Leaving stray or loose screws inside your computer may severely damage your computer.**

### Steps

1. Replace all screws and ensure that no stray screws remain inside your computer.
2. Connect any external devices, peripherals, or cables you removed before working on your computer.
3. Replace any media cards, discs, or any other parts that you removed before working on your computer.
4. Connect your computer and all attached devices to their electrical outlets.
5. Turn on your computer.

# Removing and installing components

**NOTE:** The images in this document may differ from your computer depending on the configuration you ordered.

## Topics:

- Recommended tools
- Screw list
- Major components of Vostro 14 5415
- Base cover
- Battery
- Memory module
- Solid-state drive
- Wireless card
- Fan
- Coin-cell battery
- Heat sink
- Network-port bracket
- I/O board
- Speakers
- Touchpad
- Display assembly
- Power button with optional fingerprint reader
- Power-adaptor port
- System board
- Palm-rest and keyboard assembly

## Recommended tools

The procedures in this document may require the following tools:

- Phillips screwdriver #0
- Phillips screwdriver #1
- Plastic scribe

## Screw list















**NOTE:** When removing screws from a component, it is recommended to note the screw type, the quantity of screws, and then place them in a screw storage box. This is to ensure that the correct number of screws and correct screw type is restored when the component is replaced.

**NOTE:** Some computers have magnetic surfaces. Ensure that the screws are not left attached to such surface when replacing a component.

**NOTE:** Screw color may vary with the configuration ordered.

### Table 1. Screw list

**Table 1. Screw list**

Component	Screw type	Quantity	Screw image
Base cover	<ul style="list-style-type: none"> <li>• Captive screws (M2x7.5)</li> <li>• M2x4</li> </ul>	<ul style="list-style-type: none"> <li>• 2</li> <li>• 5</li> </ul>	
3-cell battery	M2x3	3	
4-cell battery	M2x3	5	
WLAN	M2x3	1	
Solid-state drive	M2x3	1	
Fan	M2x3	2	
Heat sink	Captive screws	4	
System board	M2x2	2	
Type-C bracket	M2x4	2	
Power button with fingerprint reader	M2x3	1	
Network port bracket	M2x5	2	
I/O board	M2x3	1	
Touchpad	M1.6x2 M2x1.8	3 2	
Power adapter	M2.5x5	2	
Display assembly	M2.5x5	4	

## Major components of Vostro 14 5415

The following image shows the major components of Vostro 14 5415.

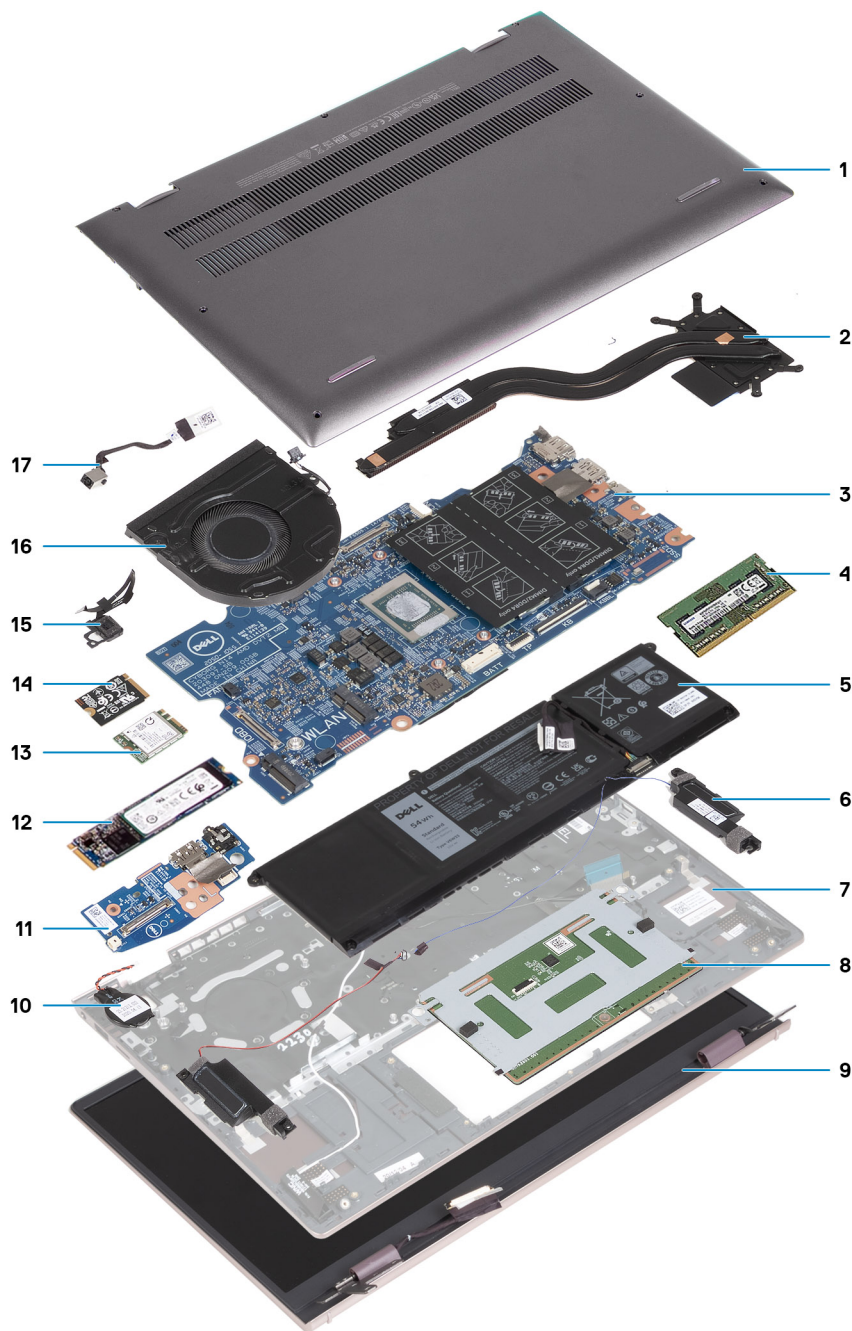

1. Base cover
2. Heat sink
3. System board
4. Memory
5. Battery
6. Right speaker
7. Palm-rest and keyboard assembly
8. Touchpad
9. Display assembly
10. Coin-cell battery
11. I/O board
12. M.2 2280 solid-state drive, if installed
13. Wireless card
14. M.2 2230 solid-state drive, if installed
15. Power-button with optional fingerprint-reader

- 16. Fan
- 17. Power-adaptor port

**i** **NOTE:** Dell provides a list of components and their part numbers for the original system configuration purchased. These parts are available according to warranty coverages purchased by the customer. Contact your Dell sales representative for purchase options.

## Base cover

### Removing the base cover

#### Prerequisites

1. Follow the procedure in [Before working inside your computer.](#)

#### About this task

**i** **NOTE:** Before removing the base cover, ensure that there is no micro-SD card installed in the micro-SD card slot on your computer.

The following image(s) indicate the location of the base cover and provides a visual representation of the removal procedure.

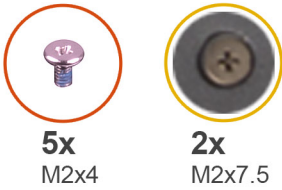

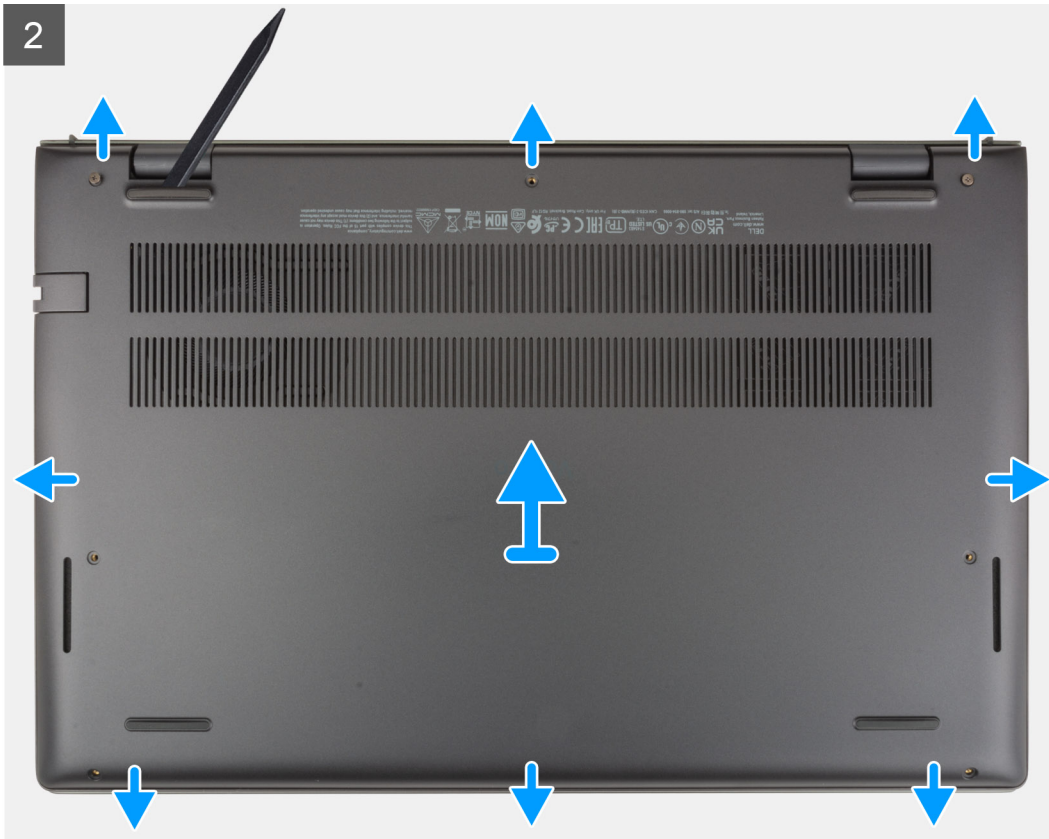

### Steps

1. Remove the five screws (M2x4) that secure the base cover to the palm-rest and keyboard assembly.
2. Loosen the two captive screws (M2x7.5) that secure the base cover to the palm-rest and keyboard assembly.
3. Using a plastic scribe, pry the base cover from the bottom left and continue to work on the sides to open the base cover.
4. Lift the base cover off the palm-rest and keyboard assembly.

## Installing the base cover

### Prerequisites

If you are replacing a component, remove the existing component before performing the installation process.

### About this task

The following image(s) indicate the location of the base cover and provides a visual representation of the installation procedure.



5x  
M2x4



2x  
M2x7.5

1

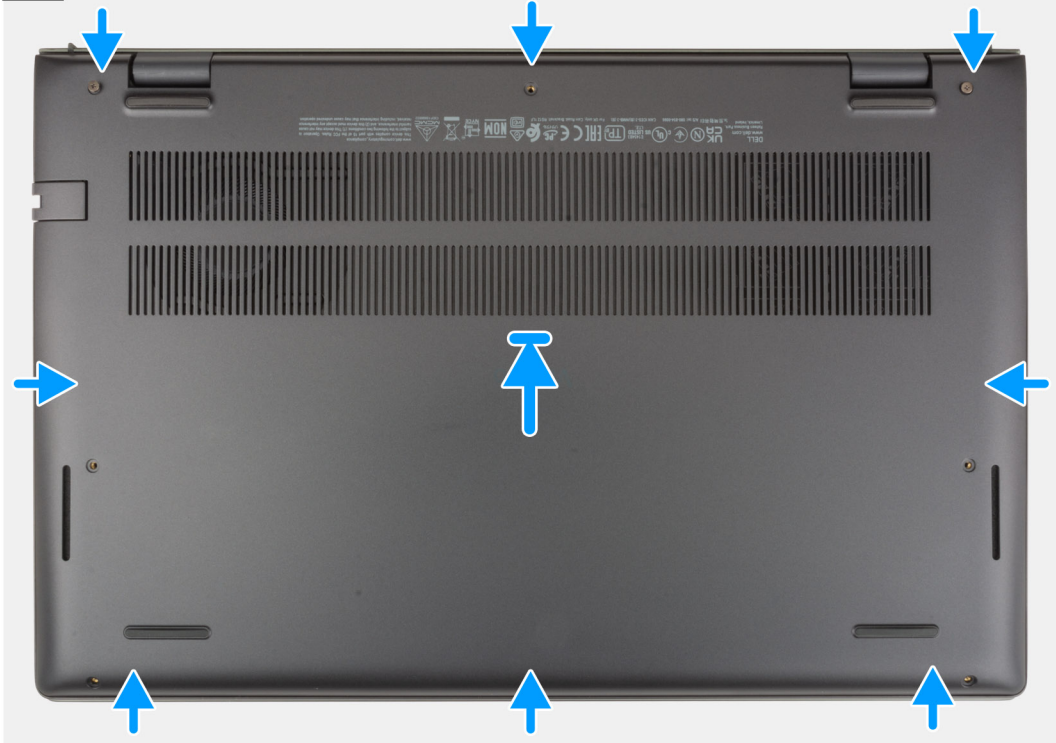

2



### Steps

1. Place and snap the base cover into place on the palm-rest and keyboard assembly.
2. Tighten the two captive screws (M2x7.5) that secure the base cover to the palm-rest and keyboard assembly.
3. Replace the five screws (M2x4) that secure the base cover to the palm-rest and keyboard assembly.

### Next steps

1. Follow the procedure in [After working inside your computer](#).

## Battery

### Lithium-ion battery precautions

#### CAUTION:

- Exercise caution when handling Lithium-ion batteries.
- Discharge the battery completely before removing it. Disconnect the AC power adapter from the system and operate the computer solely on battery power—the battery is fully discharged when the computer no longer turns on when the power button is pressed.
- Do not crush, drop, mutilate, or penetrate the battery with foreign objects.
- Do not expose the battery to high temperatures, or disassemble battery packs and cells.
- Do not apply pressure to the surface of the battery.
- Do not bend the battery.
- Do not use tools of any kind to pry on or against the battery.
- Ensure any screws during the servicing of this product are not lost or misplaced, to prevent accidental puncture or damage to the battery and other system components.
- If the battery gets stuck inside your computer as a result of swelling, do not try to release it as puncturing, bending, or crushing a lithium-ion battery can be dangerous. In such an instance, contact Dell technical support for assistance. See [www.dell.com/contactdell](http://www.dell.com/contactdell).
- Always purchase genuine batteries from [www.dell.com](http://www.dell.com) or authorized Dell partners and resellers.

### Removing the 3-cell battery

#### Prerequisites

1. Follow the procedure in [Before working inside your computer](#).
2. Remove the [base cover](#).

#### About this task

The following image(s) indicate the location of the 3-cell battery and provides a visual representation of the removal procedure.





3x  
M2x3

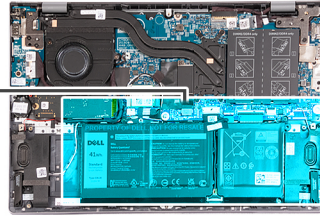
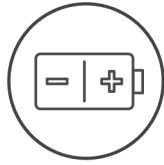

## Steps

1. Peel the tape that secures the battery cable to the 3-cell battery.
2. Disconnect the battery cable from the system board.
3. Remove the three screws (M2x3) that secure the battery to the palm-rest and keyboard assembly.
4. Lift the battery off the palm-rest and keyboard assembly.

## Installing the 3-cell battery

### Prerequisites

If you are replacing a component, remove the existing component before performing the installation process.

### About this task

The following image(s) indicate the location of the 3-cell battery and provides a visual representation of the installation procedure.



3x  
M2x3

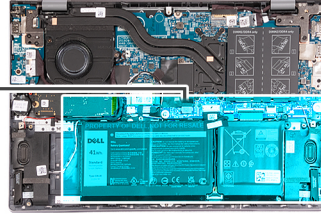
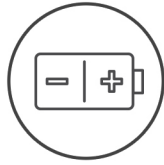

## Steps

1. Align the screw holes on the battery with the screw holes on the palm-rest and keyboard assembly.
2. Replace the three screws (M2x3) that secure the battery to the palm-rest and keyboard assembly.
3. Connect the battery cable to the system board.
4. Adhere the tape that secures the battery cable to the 3-cell battery.

## Next steps

1. Install the [base cover](#).
2. Follow the procedure in [After working inside your computer](#).

# Removing the 4-cell battery

## Prerequisites

1. Follow the procedure in [Before working inside your computer](#).
2. Remove the [base cover](#).

## About this task

The following image(s) indicate the location of the 4-cell battery and provides a visual representation of the removal procedure.



5x  
M2x3

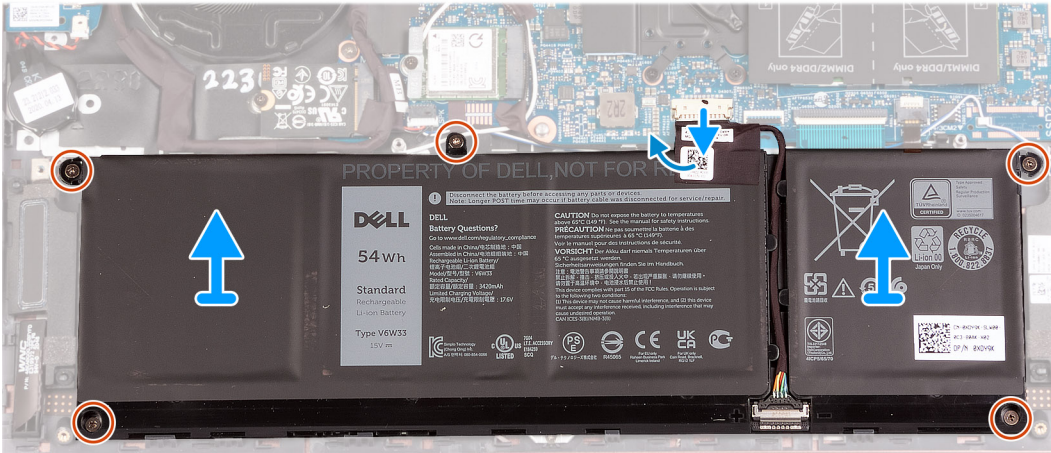
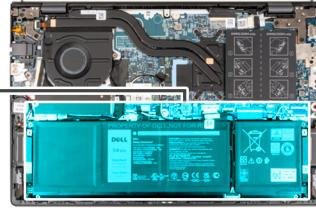
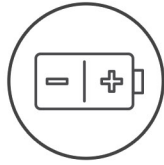

### Steps

1. Peel the tape that secures the battery cable to the 4-cell battery.
2. Disconnect the battery cable from the system board, if applicable.
3. Remove the five screws (M2x3) that secure the battery to the palm-rest and keyboard assembly.
4. Lift the battery off the palm-rest and keyboard assembly.

## Installing the 4-cell battery

### Prerequisites

If you are replacing a component, remove the existing component before performing the installation process.

### About this task

The following image(s) indicate the location of the 4-cell battery and provides a visual representation of the installation procedure.



5x  
M2x3

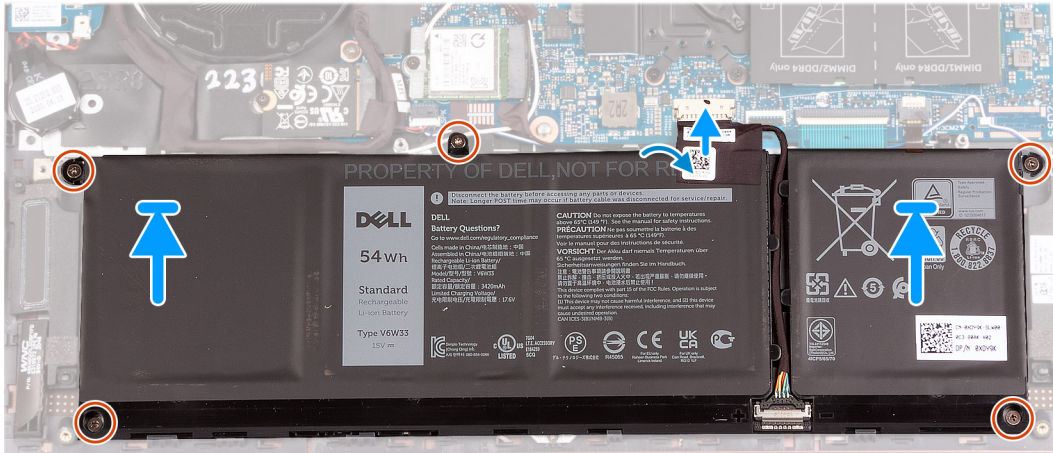
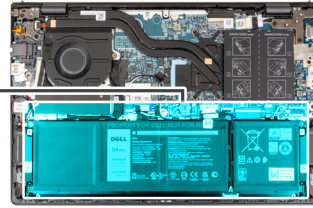
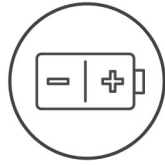

## Steps

1. Align the screw holes on the battery with the screw holes on the palm-rest and keyboard assembly.
2. Replace the five screws (M2x3) that secure the battery to the palm-rest and keyboard assembly.
3. Connect the battery cable to the system board.
4. Adhere the tape that secures the battery cable to the 4-cell battery.

## Next steps

1. Install the [base cover](#).
2. Follow the procedure in [After working inside your computer](#).

# Memory module

## Removing the memory

### Prerequisites

1. Follow the procedure in [Before working inside your computer](#).
2. Remove the [base cover](#).

### About this task

The following image(s) indicate the location of the memory and provides a visual representation of the removal procedure.

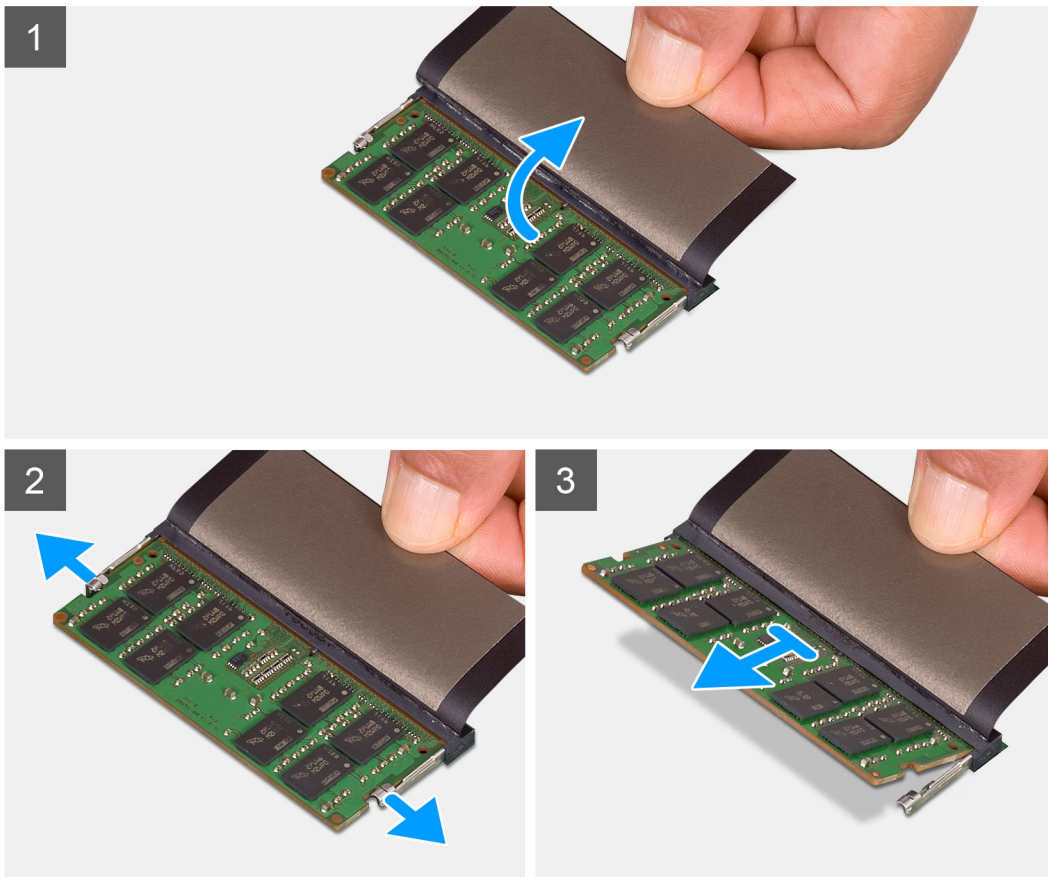
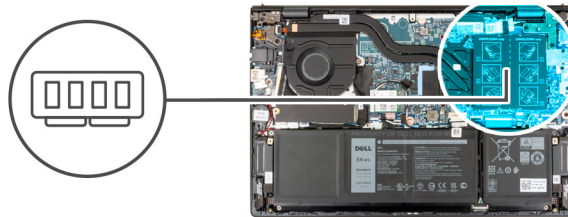

### Steps

1. Lift the Mylar to access the memory module.
2. Using your fingertips, carefully spread apart the securing-clips on each end of the memory-module slot until the memory module pops-up.
3. Remove the memory module from the memory-module slot on the system board.

**i** **NOTE:** Your computer may have up to two memory modules installed. Repeat steps 1 to 3 if there is a second memory module installed.

## Installing the memory

### Prerequisites

If you are replacing a component, remove the existing component before performing the installation process.

### About this task

The following image(s) indicate the location of the memory and provides a visual representation of the installation procedure.

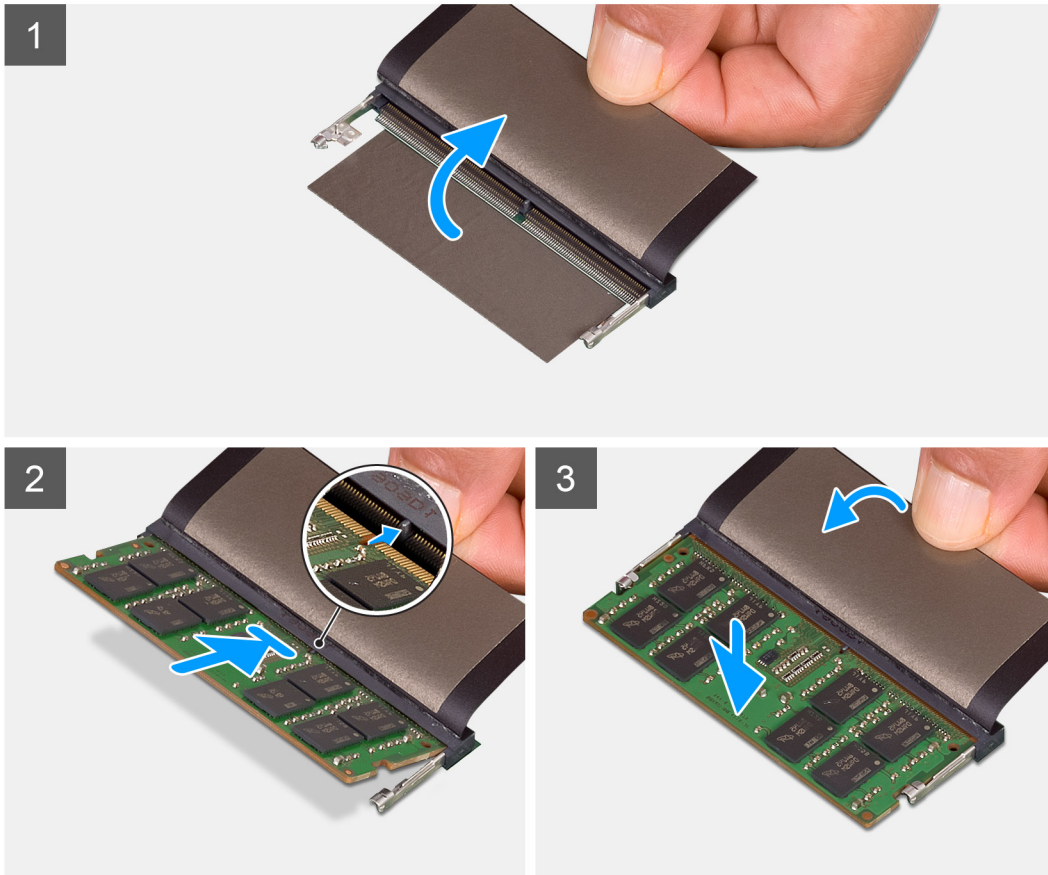
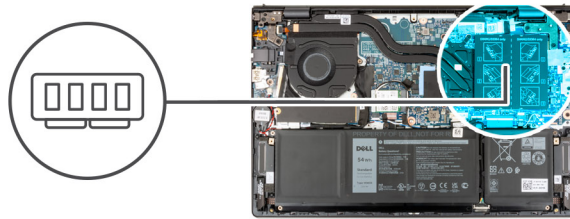

### Steps

1. Lift the Mylar to access the memory-module slot.
2. Align the notch on the memory module with the tab on the memory-module slot on the system board.
3. Slide the memory module into the memory-module slot on the system board.
4. Press down on the memory module till the securing clips click, locking the memory module in place.

**i** **NOTE:** Repeat steps 1 to 4 for each memory module being installed into your computer.

### Next steps

1. Install the [base cover](#).
2. Follow the procedure in [After working inside your computer](#).

# Solid-state drive

## Removing the M.2 2230 solid-state drive

### Prerequisites

1. Follow the procedure in [Before working inside your computer](#).
2. Remove the [base cover](#).

### About this task

- NOTE:** This procedure applies only to computers shipped with an M.2 2230 solid-state drive installed.
- NOTE:** The M.2 card installed on your computer will depend on the configuration ordered. Supported card configurations on the M.2 card slot:
- M.2 2230 solid-state drive
  - M.2 2280 solid-state drive

The following image(s) indicate the location of the M.2 2230 solid-state drive and provides a visual representation of the removal procedure.

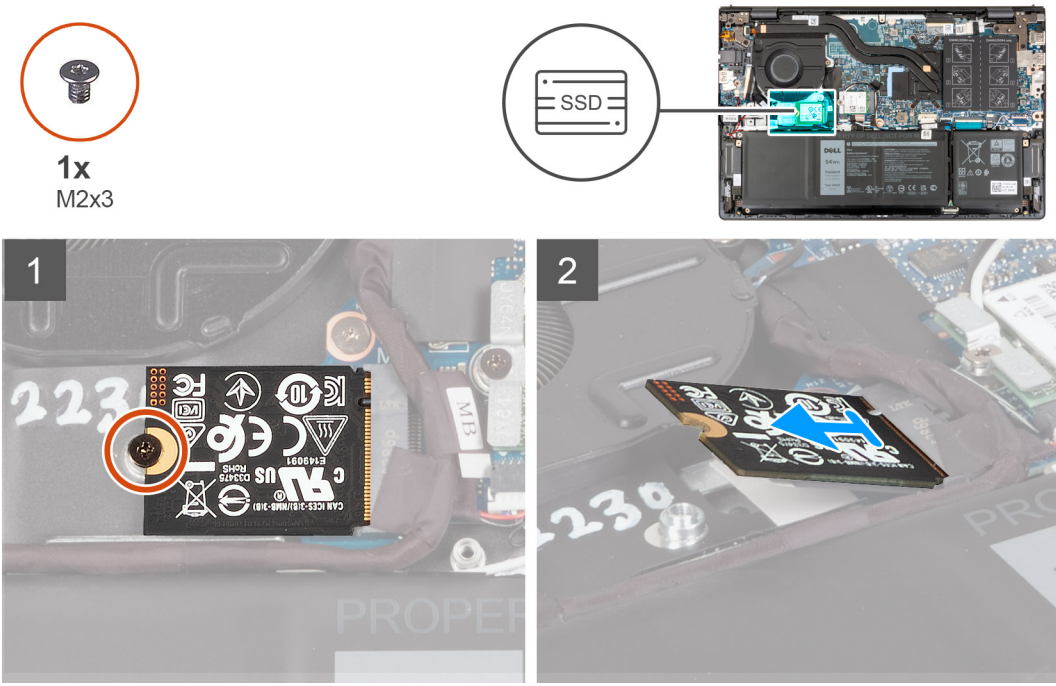

### Steps

1. Remove the screw (M2x3) that secures the M.2 2230 solid-state drive to the system board.
2. Slide and lift the M.2 2230 solid-state drive off the system board.
3. Slide and lift the M.2 2230 solid-state drive off the system board.

## Installing the M.2 2230 solid-state drive

### Prerequisites

If you are replacing a component, remove the existing component before performing the installation process.

### About this task

**NOTE:** This procedure applies if you are installing a M.2 2230 solid-state drive.

**NOTE:** The M.2 card installed on your computer will depend on the configuration ordered. Supported card configurations on the M.2 card slot:

- M.2 2230 solid-state drive + M.2 2230 solid-state drive mounting bracket
- M.2 2280 solid-state drive

The following image(s) indicate the location of the M.2 2230 solid-state drive and provides a visual representation of the installation procedure.



1x  
M2x3

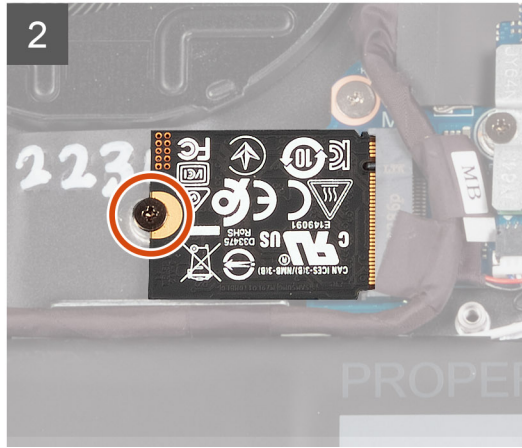
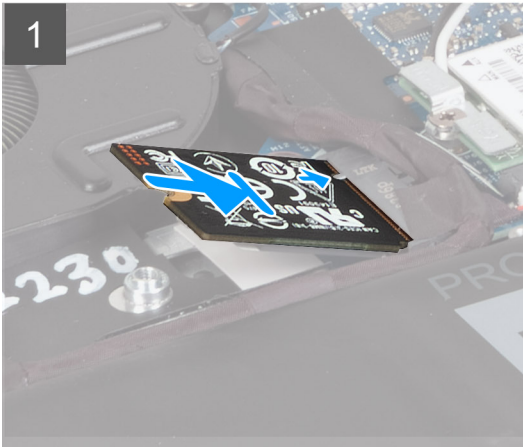
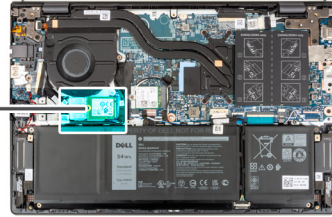

### Steps

1. Align the notch on the M.2 2230 solid-state drive with the tab on the M.2 card slot on the system board.
2. Slide the M.2 2230 solid-state drive into the M.2 card slot on the system board.
3. Replace the screw (M2x3) that secures the M.2 2230 solid-state drive to the system board.

### Next steps

1. Install the [base cover](#).
2. Follow the procedure in [After working inside your computer](#).

## Removing the M.2 2280 solid-state drive

### Prerequisites

1. Follow the procedure in [Before working inside your computer](#).
2. Remove the [base cover](#).

### About this task

**NOTE:** This procedure applies only to computers shipped with a M.2 2280 solid-state drive installed.

**NOTE:** The M.2 card installed on your computer will depend on the configuration ordered. Supported card configurations on the M.2 card slot:



- M.2 2230 solid-state drive
- M.2 2280 solid-state drive

The following image(s) indicate the location of the M.2 2280 solid-state drive and provides a visual representation of the removal procedure.

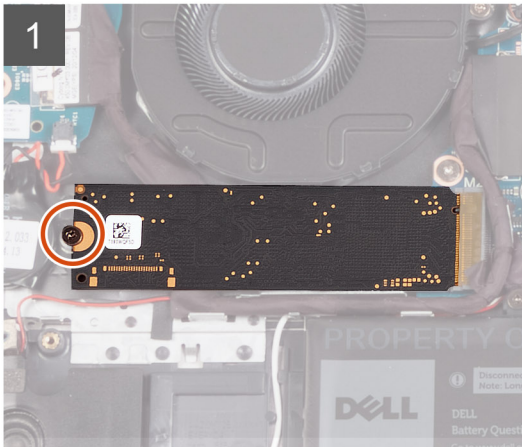
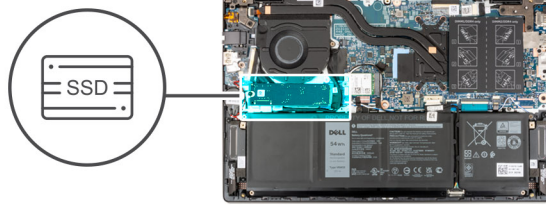

### Steps

1. Remove the screw (M2x3) that secures the M.2 2280 solid-state drive to the palm-rest and keyboard assembly.
2. Slide and remove the M.2 2280 solid-state drive from the M.2 card slot on the system board.

## Installing the M.2 2280 solid-state drive

### Prerequisites

If you are replacing a component, remove the existing component before performing the installation process.

### About this task

- NOTE:** This procedure applies if you are installing a M.2 2280 solid-state drive.
- NOTE:** The M.2 card installed on your computer will depend on the configuration ordered. Supported card configurations on the M.2 card slot:
  - M.2 2230 solid-state drive
  - M.2 2280 solid-state drive

The following image(s) indicate the location of the M.2 2280 solid-state drive and provides a visual representation of the installation procedure.



1x  
M2x3

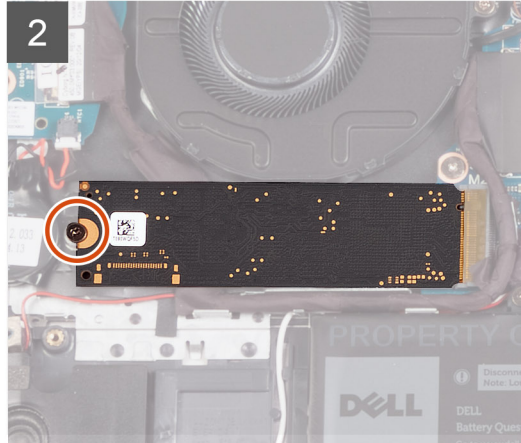
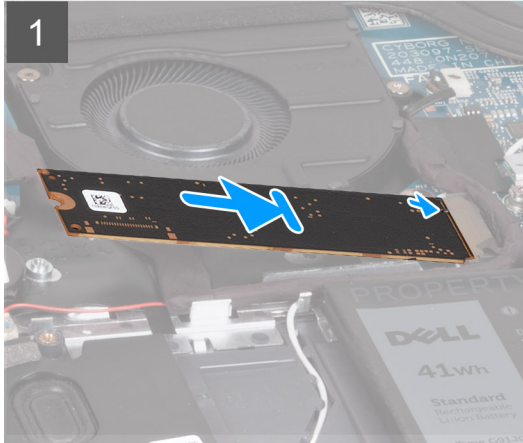
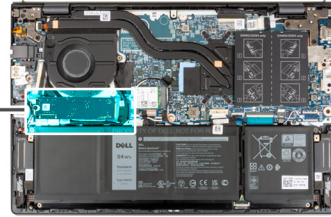

### Steps

1. Align the notch on the M.2 2280 solid-state drive with the tab on the M.2 card slot on the system board.
2. Slide the M.2 2280 solid-state drive into the M.2 card slot on the system board.
3. Replace the screw (M2x3) that secures the M.2 2280 solid-state drive to the palm-rest and keyboard assembly.

### Next steps

1. Install the [base cover](#).
2. Follow the procedure in [After working inside your computer](#).

## Installing the solid-state drive mounting bracket

### About this task

The following image provides a visual representation of the procedure to install the solid-state drive mounting bracket when replacing a M.2 2230 solid-state drive with a M.2 2280 solid-state drive.

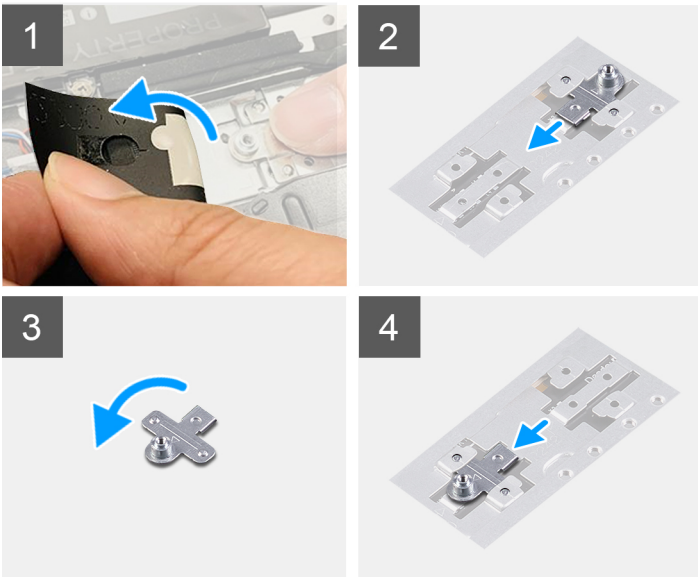

The following image provides a visual representation of the procedure to install the solid-state drive mounting bracket when replacing a M.2 2280 solid-state drive with a M.2 2230 solid-state drive.

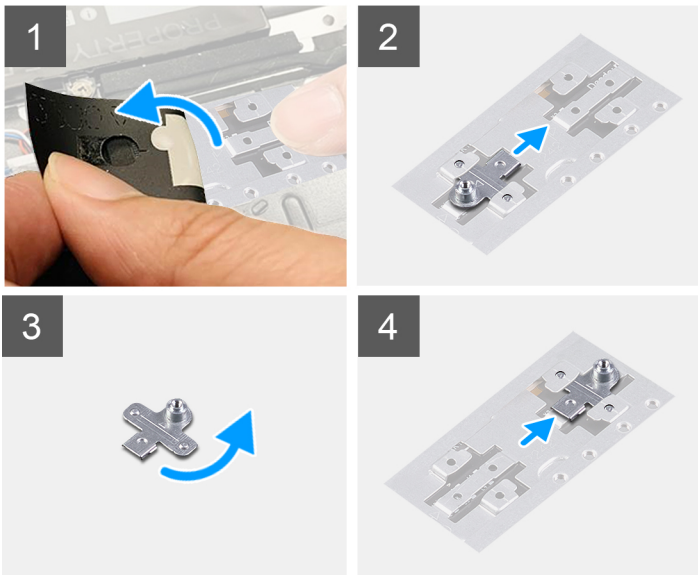

### Steps

1. Remove the [2230 solid-state drive](#) or [2280 solid-state drive](#), whichever applicable.
2. Peel the Mylar that covers the solid-state drive mounting-bracket and mounting-bracket slot.
3. Slide and remove the solid-state drive mounting-bracket from the mounting-bracket slot on the palm-rest and keyboard assembly.
4. Rotate the solid-state drive mounting-bracket.
5. Slide the solid-state mounting-bracket into the mounting-bracket slot on the palm-rest and keyboard assembly.
6. Adhere the Mylar that covers the solid-state drive mounting-bracket and mounting-bracket slot.
7. Install the [2230 solid-state drive](#) or [2280 solid-state drive](#), whichever applicable.

# Wireless card

## Removing the wireless card

### Prerequisites

1. Follow the procedure in [Before working inside your computer](#).
2. Remove the [base cover](#).

### About this task

The following image(s) indicate the location of the wireless card and provides a visual representation of the removal procedure.



1x  
M2x3

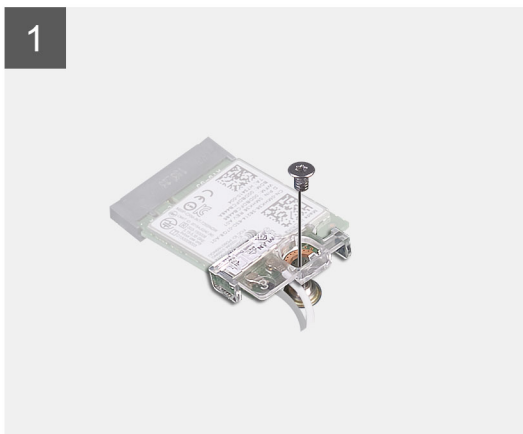

### Steps

1. Remove the screw (M2x3) that secures the wireless-card bracket to the wireless card and system board.
2. Lift the wireless-card bracket off the wireless card.
3. Disconnect the antenna cables from the wireless card.
4. Slide and remove the wireless card from the M.2 card slot on the system board.

# Installing the wireless card

## Prerequisites

If you are replacing a component, remove the existing component before performing the installation process.

## About this task

The following image(s) indicate the location of the wireless card and provides a visual representation of the installation procedure.



1x  
M2x3

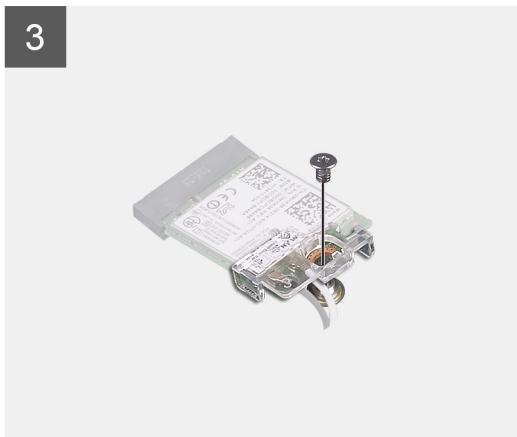

## Steps

1. Connect the antenna cables to the wireless card.

**Table 2. Antenna-cable color scheme**

Connectors on the wireless card	Antenna-cable color	Silkscreen marking	
Main	White	MAIN	△ (white triangle)
Auxiliary	Black	AUX	▲ (black triangle)

2. Place the wireless-card bracket on the wireless card.
3. Align the notch on the wireless card with the tab on the M.2 card slot on the system board.
4. Slide the wireless card into the M.2 card slot on the system board.
5. Replace the screw (M2x3) that secures the wireless card and wireless-card bracket to the system board.

### Next steps

1. Install the [base cover](#).
2. Follow the procedure in [After working inside your computer](#).

## Fan

### Removing the fan

#### Prerequisites

1. Follow the procedure in [Before working inside your computer](#).
2. Remove the [base cover](#).

#### About this task

The following image(s) indicate the location of the fan and provides a visual representation of the removal procedure.



2x  
M2x3

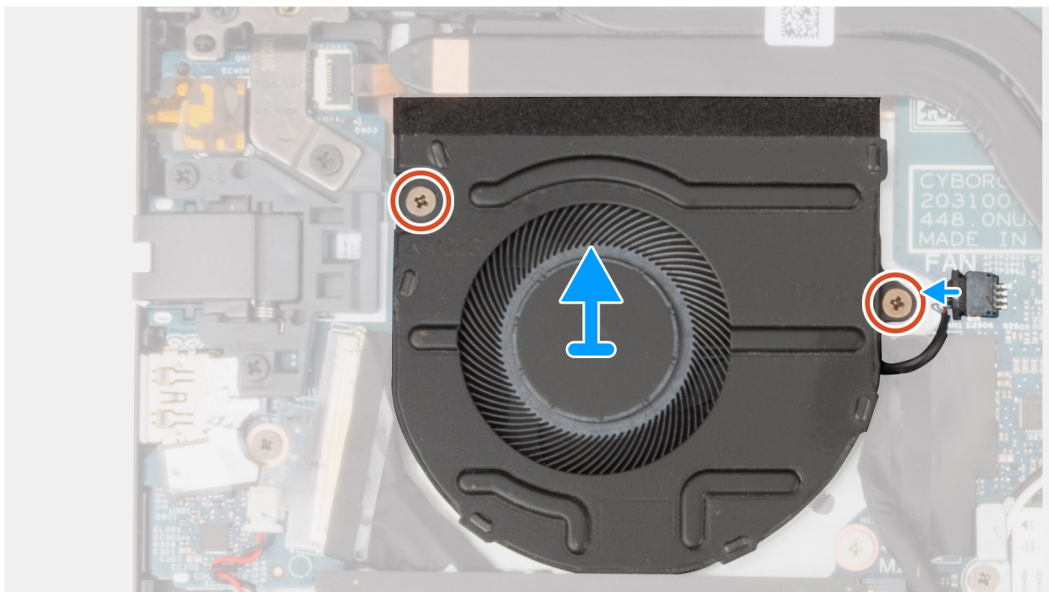
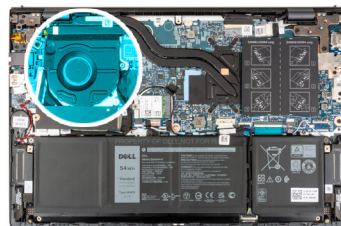

#### Steps

1. Disconnect the fan cable from the system board.
2. Remove the two screws (M2x3) that secure the fan to the palm-rest and keyboard assembly.
3. Lift the fan off the palm-rest and keyboard assembly.

# Installing the fan

## Prerequisites

If you are replacing a component, remove the existing component before performing the installation process.

## About this task

The following image(s) indicate the location of the fan and provides a visual representation of the installation procedure.



2x  
M2x3

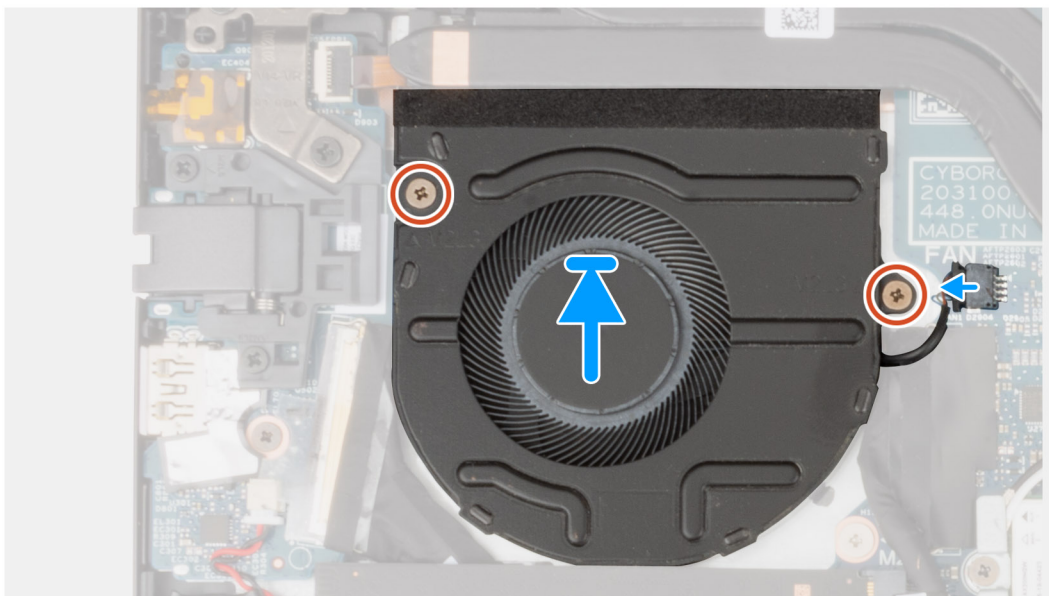
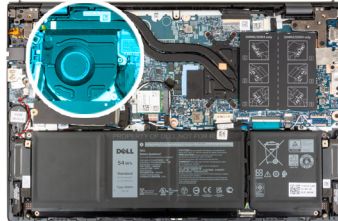

## Steps

1. Place the fan on the palm-rest and keyboard assembly.
2. Align the screw holes on the fan with the screw holes on the palm-rest and keyboard assembly.
3. Replace the two screws (M2x3) that secure the fan to the palm-rest and keyboard assembly.
4. Connect the fan cable to the system board.

## Next steps

1. Install the [base cover](#).
2. Follow the procedure in [After working inside your computer](#).

# Coin-cell battery

## Removing the coin-cell battery

### Prerequisites

1. Follow the procedure in [Before working inside your computer](#).

2. Remove the [base cover](#).

### About this task

The following image(s) indicate the location of the coin-cell battery and provides a visual representation of the removal procedure.

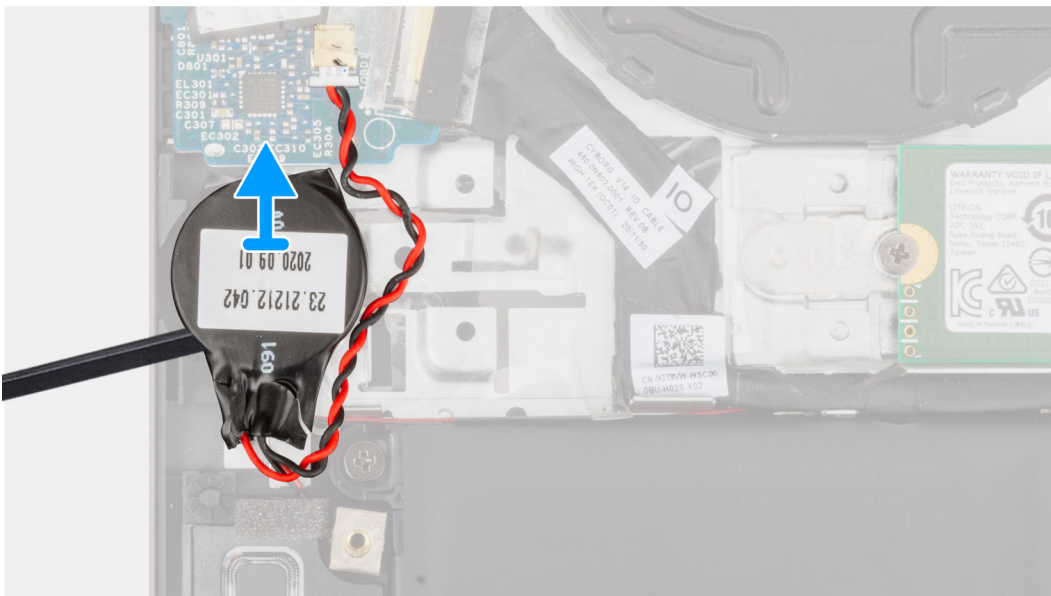
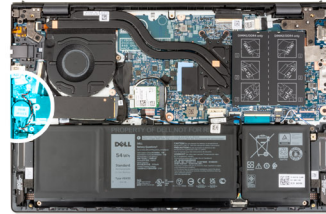

### Steps

1. Disconnect the coin-cell battery from the I/O board.
2. Peel and lift the coin-cell battery from the palm-rest and keyboard assembly.

## Installing the coin-cell battery

### Prerequisites

If you are replacing a component, remove the existing component before performing the installation process.

### About this task

The following image(s) indicate the location of the coin-cell battery and provides a visual representation of the installation procedure.



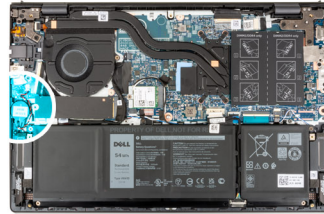

### Steps

1. Connect the coin-cell battery cable to the I/O board.
2. Adhere the coin-cell battery to the palm-rest and keyboard assembly.

### Next steps

1. Install the [base cover](#).
2. Follow the procedure in [After working inside your computer](#).

## Heat sink

### Removing the heat sink

#### Prerequisites

1. Follow the procedure in [Before working inside your computer](#).
2. Remove the [base cover](#).

#### About this task

**CAUTION:** The heat sink may become hot during normal operation. Allow sufficient time for the heat sink to cool before you touch it.

**NOTE:** For maximum cooling of the processor, do not touch the heat transfer areas on the heat sink. The oils in your skin can reduce the heat transfer capability of the thermal grease.

The following image(s) indicate the location of the heat sink and provides a visual representation of the removal procedure.



4x

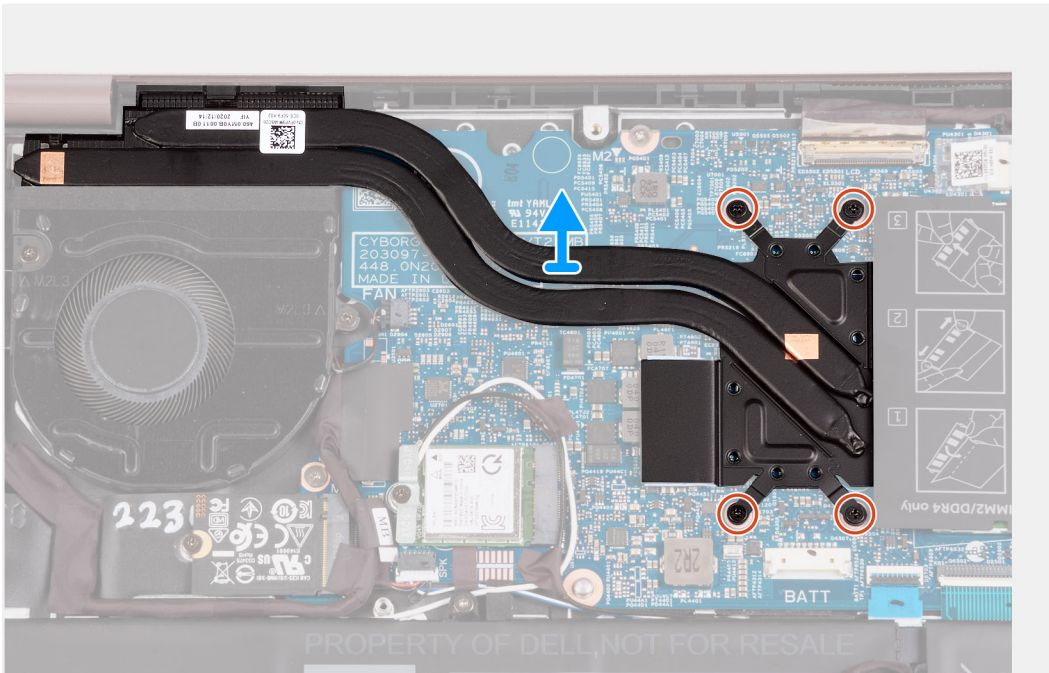
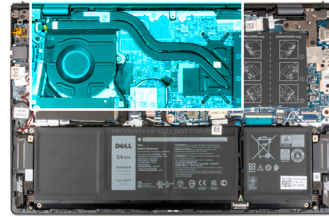

### Steps

1. In reverse sequential order (7>6>5>4>3>2>1) loosen the seven captive screws that secure the heat sink to the system board.

 **NOTE:** The number of screws varies depending on the configuration ordered.

2. Lift the heat sink from the system board.

## Installing the heat sink

### Prerequisites

If you are replacing a component, remove the existing component before performing the installation process.

### About this task

 **NOTE:** If either the system board or the heat sink is replaced, use the thermal grease provided in the kit to ensure that thermal conductivity is achieved.

The following image(s) indicate the location of the heat sink and provides a visual representation of the installation procedure.



4x

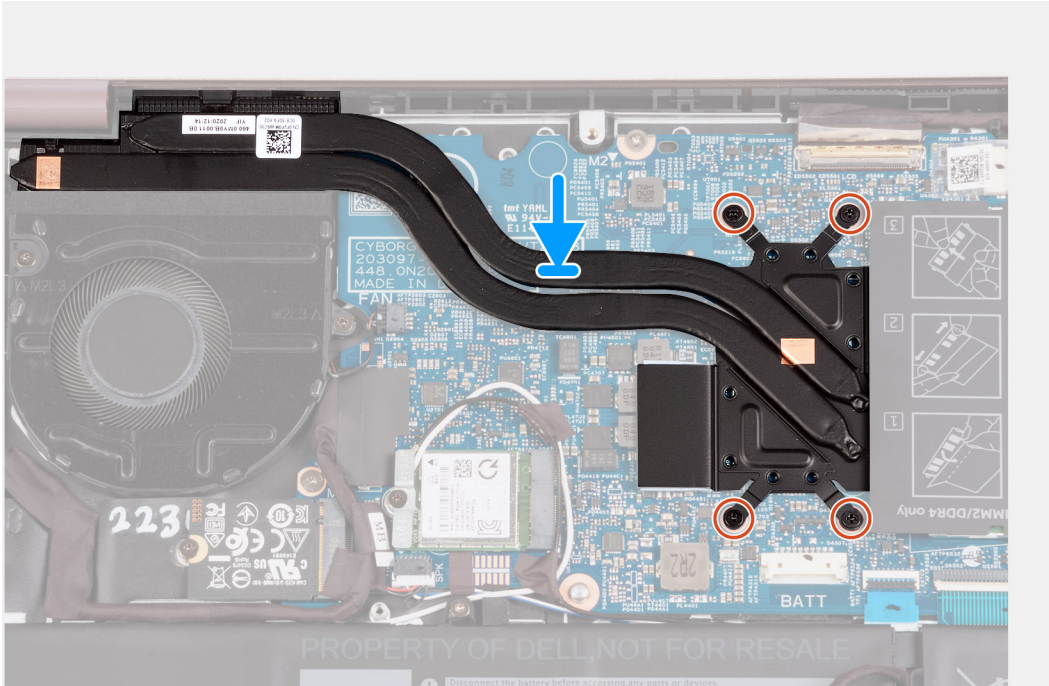
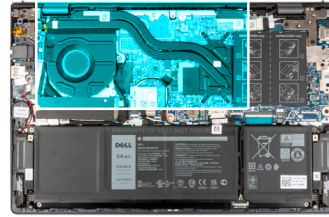

### Steps

1. Place the heat-sink on the system board.
2. Align the screw holes on the heat sink to the screw holes on the system board.
3. In sequential order (1>2>3>4>5>6>7) tighten the seven captive screws that secure the heat sink to the system board.

**NOTE:** The number of screws varies depending on the configuration ordered.

### Next steps

1. Install the [base cover](#).
2. Follow the procedure in [After working inside your computer](#).

## Network-port bracket

### Removing the network-port bracket

#### Prerequisites

1. Follow the procedure in [Before working inside your computer](#).
2. Remove the [base cover](#).

#### About this task

The following image(s) indicate the location of the network-port bracket and provides a visual representation of the removal procedure.

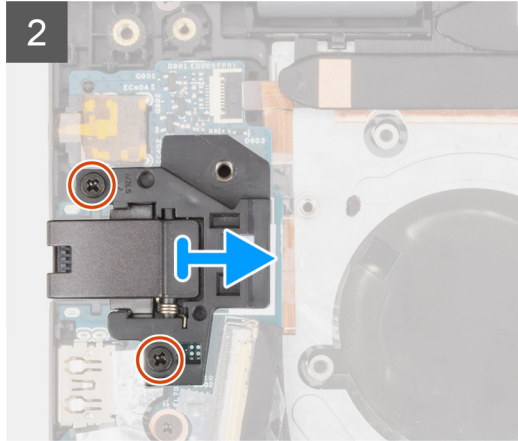
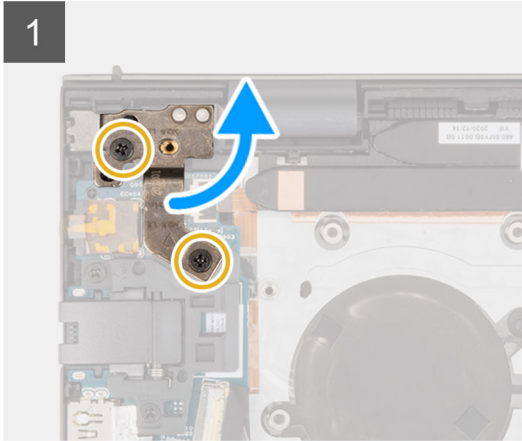
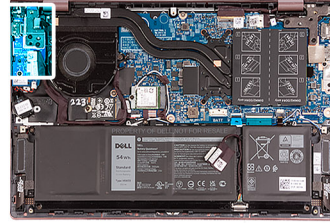

### Steps

1. Remove the two screws (M2.5x5) that secure the left-display hinge to the I/O board.
2. Pry open the left-display hinge at an angle of 90 degrees.
3. Remove the two screws (M2x5) that secure the network-port bracket to the I/O board.
4. Lift the network-port bracket off the I/O board.

## Installing the network-port bracket

### Prerequisites

If you are replacing a component, remove the existing component before performing the installation process.

### About this task

The following image(s) indicate the location of the network-port bracket and provides a visual representation of the installation procedure.

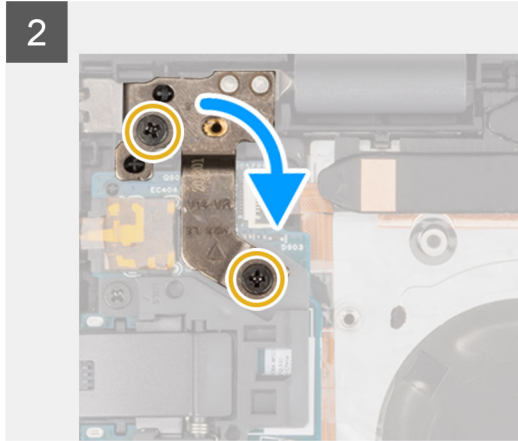
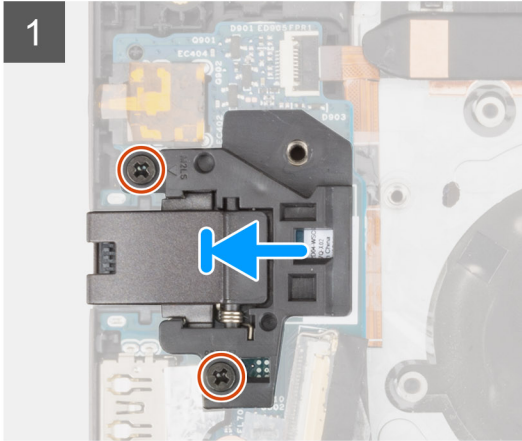
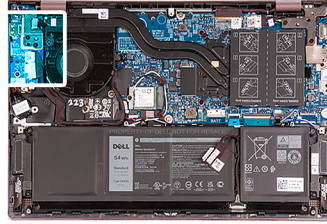

### Steps

1. Place the network-port bracket on the I/O board.
2. Align the screw holes on the network-port bracket to the screw holes on the I/O board.
3. Replace the two screws (M2x5) that secure the network-port bracket to the I/O board.
4. Close the left-display hinge and align the screw holes on the left-display hinge with the screw holes on the I/O board.
5. Replace the two screws (M2.5x5) that secure the left-display hinge to the palm-rest and keyboard assembly.

### Next steps

1. Install the [base cover](#).
2. Follow the procedure in [After working inside your computer](#).

## I/O board

### Removing the I/O board

#### Prerequisites

1. Follow the procedure in [Before working inside your computer](#).
2. Remove the [base cover](#).
3. Remove the [network-port bracket](#).

#### About this task

The following image(s) indicate the location of the I/O board and provides a visual representation of the removal procedure.



1x  
M2x3

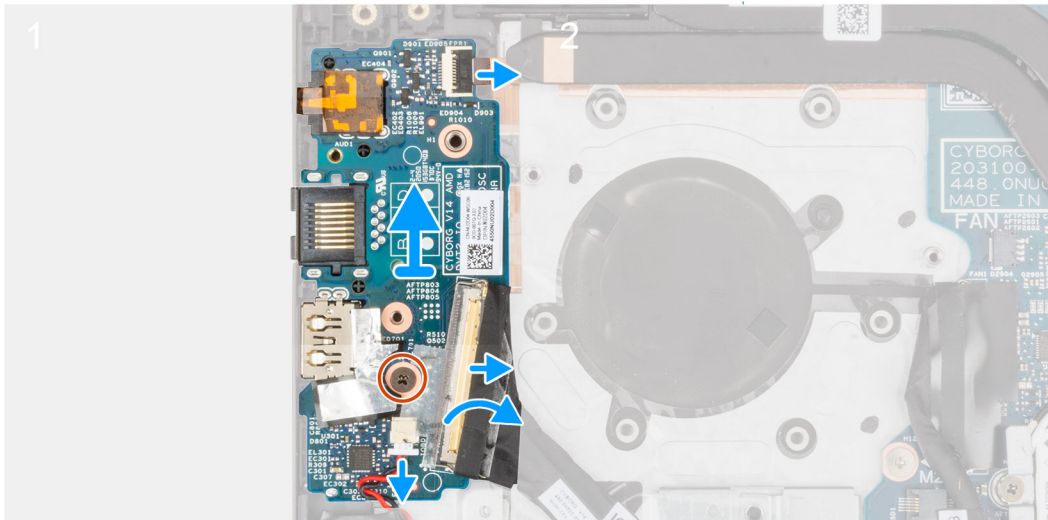
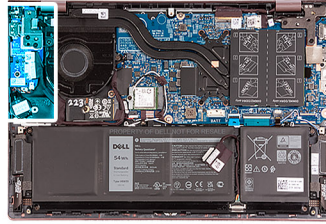

### Steps

1. Lift the I/O-board cable-connector latch and disconnect the I/O-board cable from the I/O board.
2. Lift the power-button with fingerprint-reader cable-connector latch and disconnect the power-button with fingerprint-reader cable from the I/O board.  
**i** **NOTE:** This step is only applicable for computers shipped with the optional fingerprint reader.
3. Remove the screw (M2x3) that secures the I/O board to the palm-rest and keyboard assembly.
4. Disconnect the coin-cell battery cable from the I/O board.
5. Lift the I/O board off the palm-rest and keyboard assembly.

## Installing the I/O board

### Prerequisites

If you are replacing a component, remove the existing component before performing the installation process.

### About this task

The following image(s) indicate the location of the I/O board and provides a visual representation of the installation procedure.



1x  
M2x3

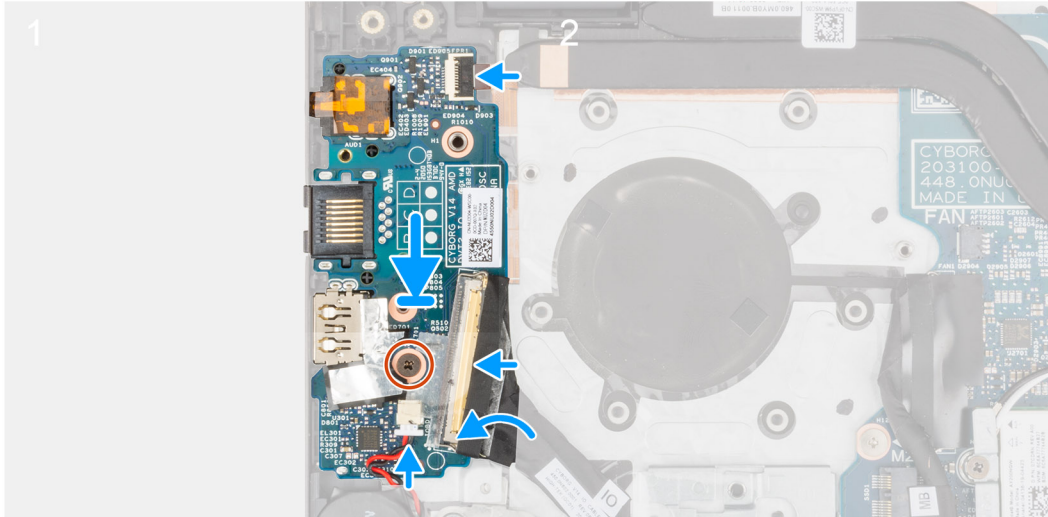
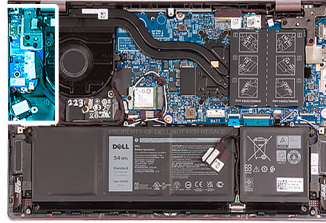

### Steps

1. Align the ports on the I/O board to the slots on the palm-rest and keyboard assembly.
2. Place the I/O board on the palm-rest and keyboard assembly.
3. Align the screw hole on the I/O board to the screw hole on the palm-rest and keyboard assembly.
4. Replace the screw (M2x3) that secures the I/O board to the palm-rest and keyboard assembly.
5. Connect the I/O-board cable to the connector on the I/O board and close the latch.
6. Connect the power-button with fingerprint-reader cable to the connector on the I/O board and close the latch.  
**i** **NOTE:** This step is only applicable for computers shipped with the optional fingerprint reader.
7. Connect the coin-cell battery cable to the I/O board.

### Next steps

1. Install the [network-port bracket](#).
2. Install the [base cover](#).
3. Follow the procedure in [After working inside your computer](#).

## Speakers

### Removing the speakers

#### Prerequisites

1. Follow the procedure in [Before working inside your computer](#).
2. Remove the [base cover](#).
3. Remove the [3-cell battery](#) or the [4-cell battery](#), whichever applicable.

## About this task

The following image(s) indicate the location of the speakers and provides a visual representation of the removal procedure.

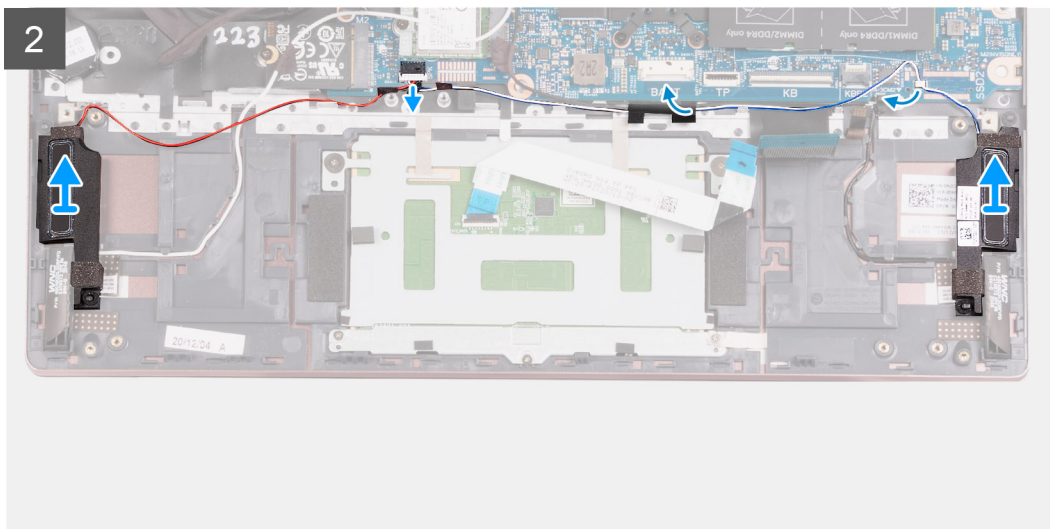
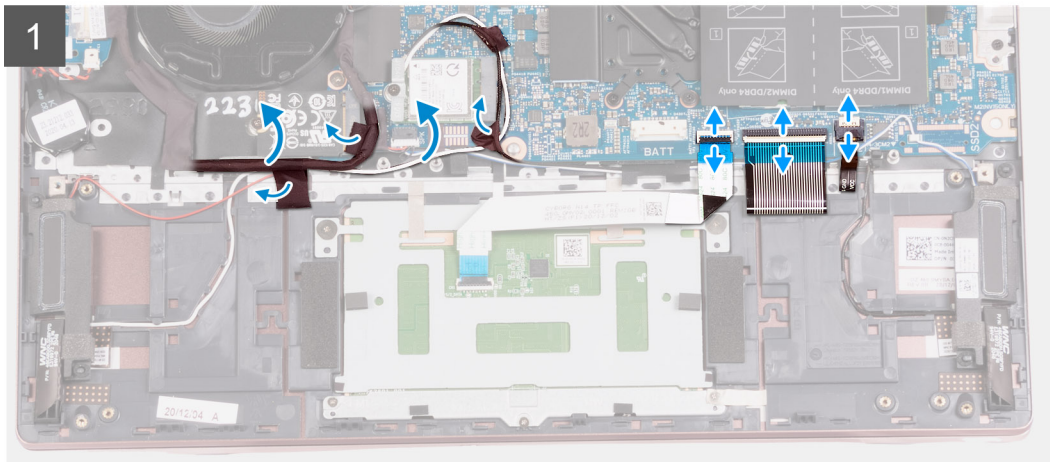
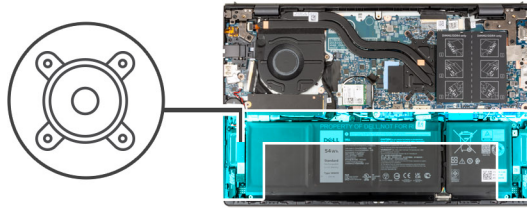

## Steps

1. Peel off the tapes that secure the I/O-board cable and antenna cables to the palm-rest and keyboard assembly.
2. Lift the I/O-board cable and antenna cables and move them out of the way.
3. Lift the latch and disconnect the touchpad cable from the system board.
4. Lift the latch and disconnect the keyboard cable from the system board.
5. Lift the latch and disconnect the keyboard-backlight cable from the system board.
6. Disconnect the speaker cable from the system board.
7. Peel off the tape that secures the speaker cable to the palm-rest and keyboard assembly.
8. Remove the speaker cables from the routing guides on the palm-rest and keyboard assembly.
9. Lift the speakers along with their cables off the palm-rest and keyboard assembly.



# Installing the speakers

## Prerequisites

If you are replacing a component, remove the existing component before performing the installation process.

## About this task

The following image(s) indicate the location of the speakers and provides a visual representation of the installation procedure.

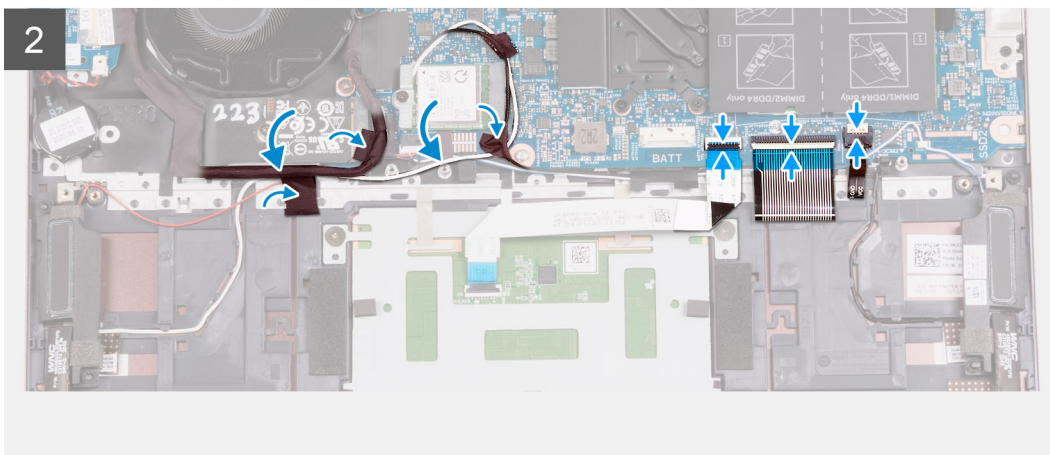
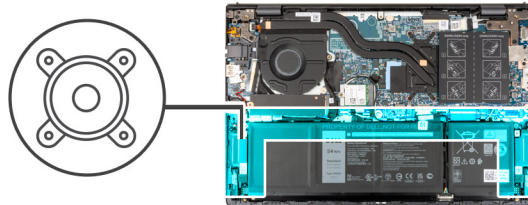

## Steps

1. Using the alignment posts, place the left and right speakers on the palm-rest and keyboard assembly.  
**NOTE:** Ensure that the alignment posts are threaded through the rubber grommets on the speaker.
2. Route the speaker cable through the routing guides on the palm-rest and keyboard assembly.
3. Connect the speaker cable to the connector on the system board.
4. Adhere the tape that secures the speaker cable to the palm-rest and keyboard assembly.
5. Connect the touchpad cable to the system board and close the latch.
6. Connect the keyboard cable to the system board and close the latch.

7. Connect the keyboard-backlight cable to the system board and close the latch.
8. Place the I/O-board and antenna cables back into place and adhere the tapes that secure them to the palm-rest and keyboard assembly.

### Next steps

1. Install the [3-cell battery](#) or the [4-cell battery](#), whichever applicable.
2. Install the [base cover](#).
3. Follow the procedure in [After working inside your computer](#).

## Touchpad

### Removing the touchpad

#### Prerequisites

1. Follow the procedure in [Before working inside your computer](#).
2. Remove the [base cover](#).
3. Remove the [3-cell battery](#) or the [4-cell battery](#), whichever applicable.

#### About this task

The following image(s) indicate the location of the touchpad and provides a visual representation of the removal procedure.

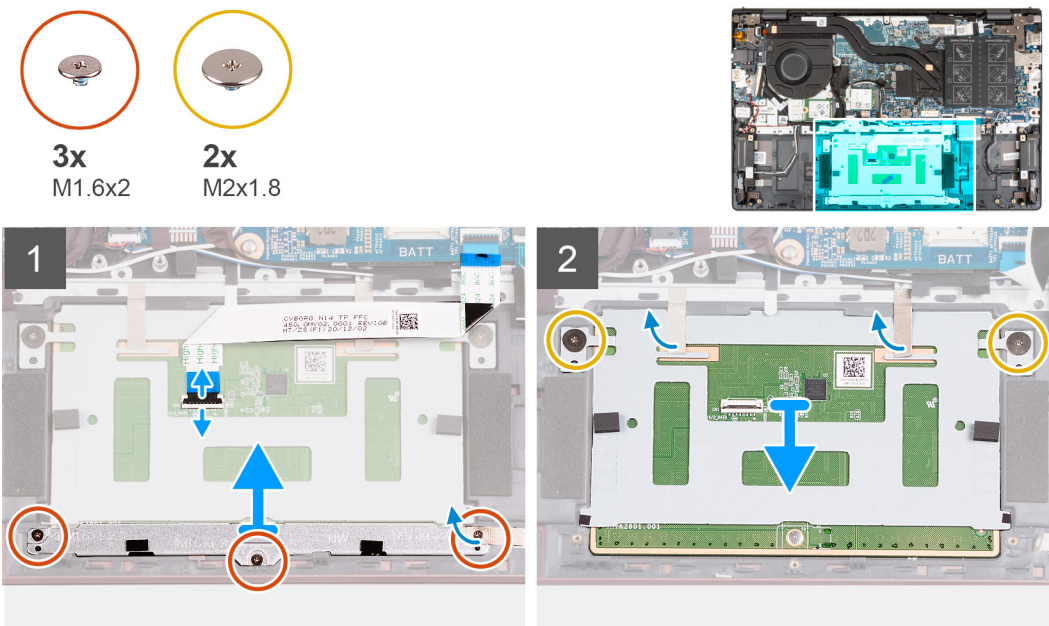

#### Steps

1. Open the latch and disconnect the touchpad cable from the touchpad.
2. Remove the three screws (M1.6x2) that secure the touchpad bracket to the palm-rest and keyboard assembly.
3. Lift the touchpad bracket off the palm-rest and keyboard assembly.
4. Remove the two screws (M2x1.8) that secure the touchpad to the palm-rest and keyboard assembly.
5. Peel the tapes that secure the touchpad to the palm-rest and keyboard assembly.
6. Lift the touchpad off the palm-rest and keyboard assembly.

# Installing the touchpad

## Prerequisites

If you are replacing a component, remove the existing component before performing the installation process.

## About this task

The following image(s) indicate the location of the touchpad and provides a visual representation of the installation procedure.

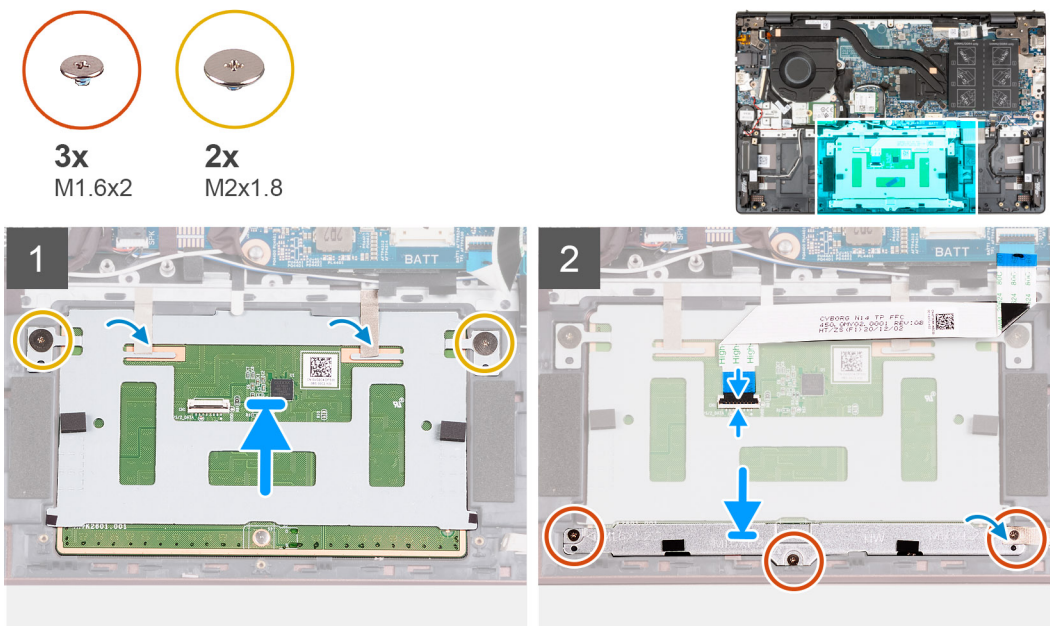

## Steps

1. Place the touchpad on the palm-rest and keyboard assembly.
2. Turn the computer over and open the display to ensure that the touchpad is equally aligned on all sides.

**NOTE:** The image below shows the proper touchpad alignment for your computer.

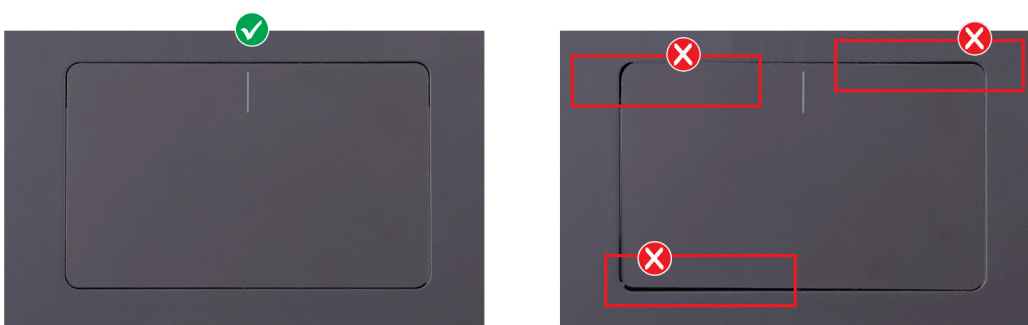

3. Close the display and place the computer in the position shown.
4. Replace the two screws (M2x1.8) that secure the touchpad to the palm-rest and keyboard assembly.
5. Place the touchpad bracket on the touchpad.
6. Align the screw holes on the touchpad bracket to the screw holes on the palm-rest and keyboard assembly.
7. Replace the three screws (M1.6x2) that secure the touchpad bracket to the palm-rest and keyboard assembly.
8. Adhere the tapes that secure the touchpad to the palm-rest and keyboard assembly.
9. Connect the touchpad cable to the touchpad and close the latch.

**Next steps**

1. Install the [3-cell battery](#) or the [4-cell battery](#), whichever applicable.
2. Install the [base cover](#).
3. Follow the procedure in [After working inside your computer](#).

## Display assembly

### Removing the display assembly

**Prerequisites**

1. Follow the procedure in [Before working inside your computer](#).
2. Remove the [base cover](#).

**About this task**

The following image(s) indicate the location of the display assembly and provides a visual representation of the removal procedure.



4x  
M2.5x5

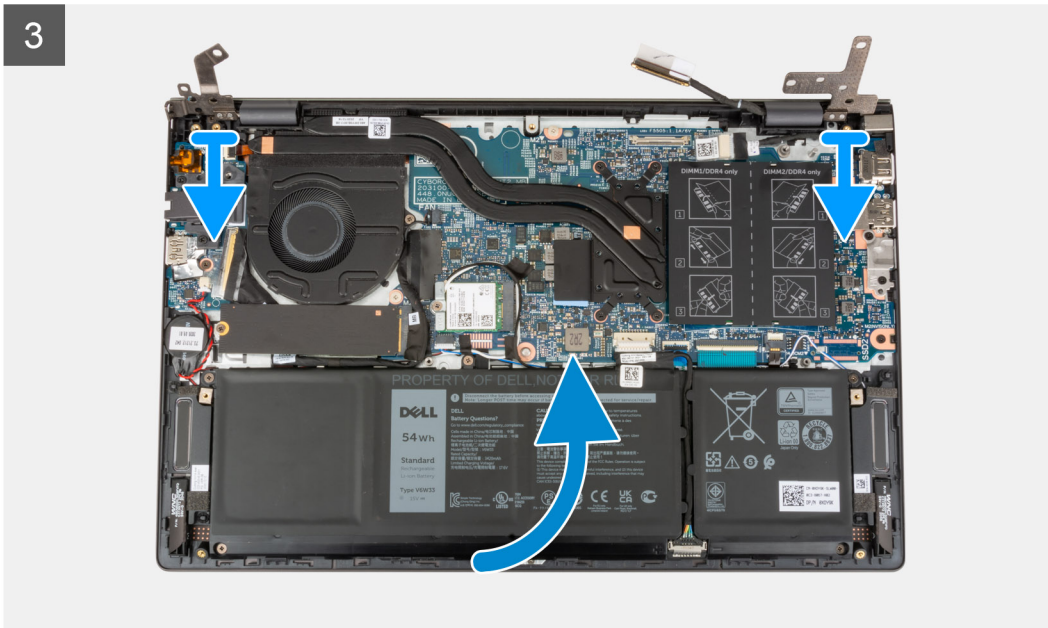
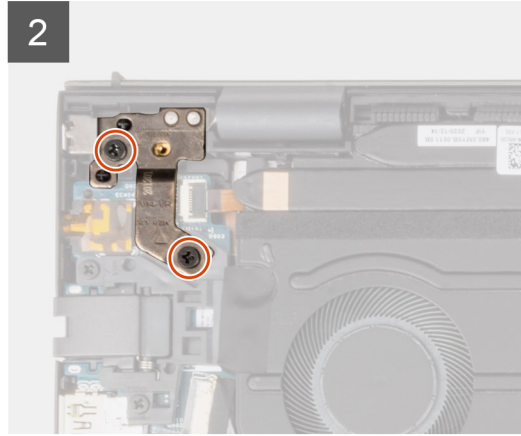
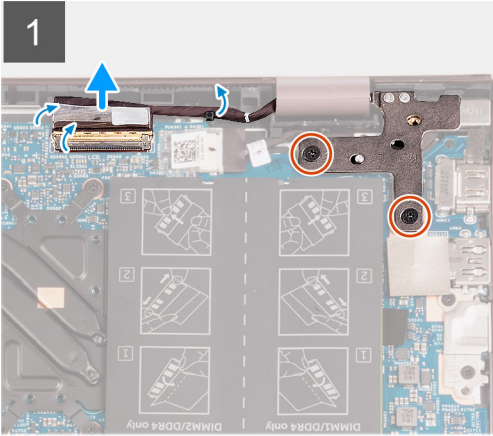



### Steps

1. Peel the tape that secures the display-cable connector latch to the system board.
2. Lift the latch and disconnect the display-cable from the connector on the system board.
3. Remove the two screws (M2.5x5) that secure the right-display hinge to the system board.
4. Pry open the right-display hinge at an angle of 90 degrees.
5. Remove the two screws (M2.5x5) that secure the left-display hinge to the I/O board.
6. Pry open the left-display hinge at an angle of 90 degrees.
7. Gently lift the palm-rest and keyboard assembly off the display assembly

 **CAUTION: To avoid damaging the display, do not slide the palm-rest and keyboard assembly over the display assembly.**

## Installing the display assembly

### Prerequisites

If you are replacing a component, remove the existing component before performing the installation process.

### About this task

The following image(s) indicate the location of the display assembly and provides a visual representation of the installation procedure.



4x  
M2.5x5

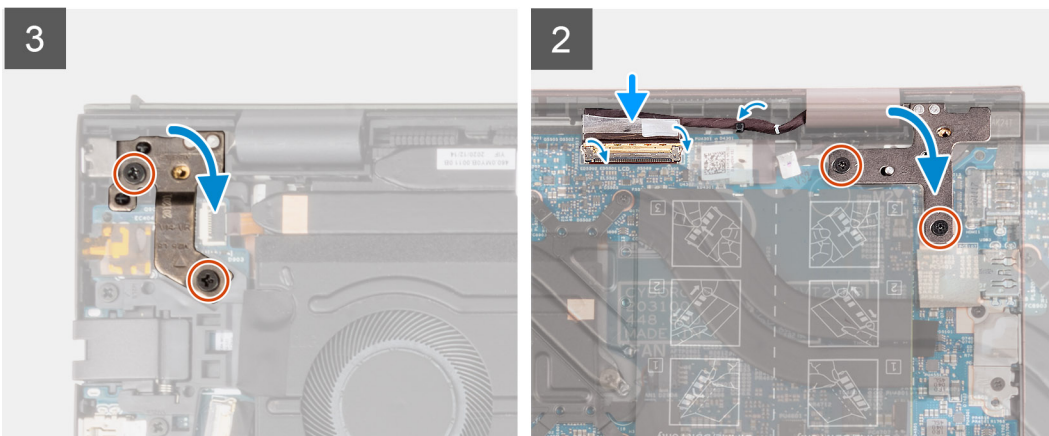
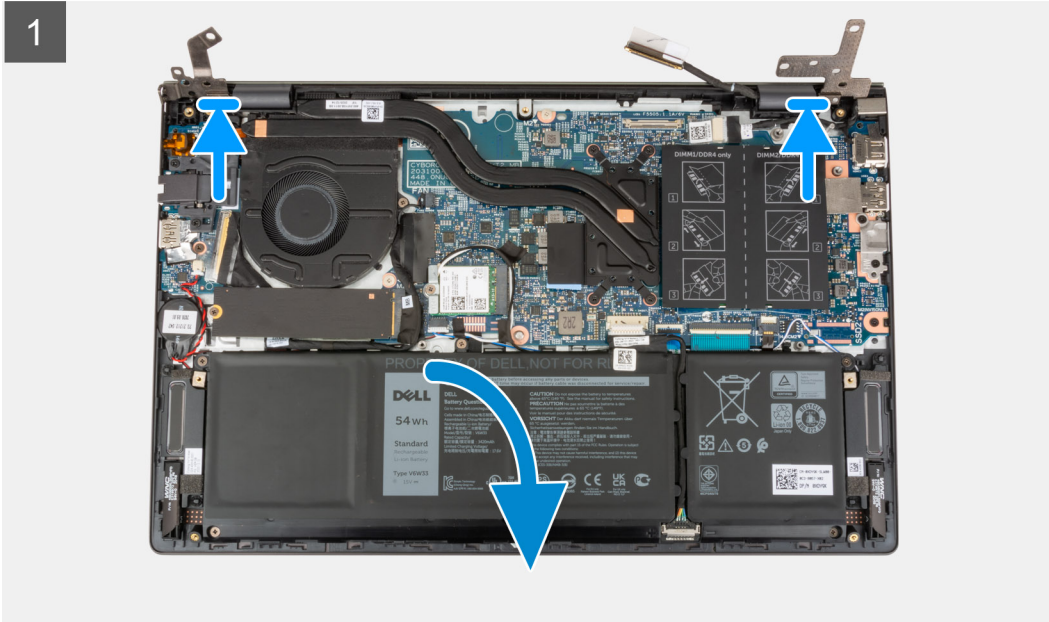
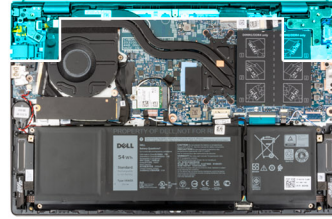

### Steps

1. Place the display assembly on a clean and flat surface with the display panel facing up.
2. Gently place the palm-rest and keyboard assembly under the display hinges.

 **CAUTION:** To avoid damaging the display, do not slide the palm-rest and keyboard assembly over the display assembly.

3. Close the left-display hinge and align the screw holes on the left-display hinge with the screw holes on the I/O board.
4. Replace the two screws (M2.5x5) that secure the left-display hinge to the palm-rest and keyboard assembly.
5. Close the right-display hinge and align the screw holes on the right-display hinge with the screw holes on the system board.
6. Replace the two screws (M2.5x5) that secure the right-display hinge to the palm-rest and keyboard assembly.
7. Connect the display cable to the connector on the system board and close the latch.
8. Adhere the tape that secures the display-cable connector latch to the system board.

### Next steps

1. Install the [base cover](#).
2. Follow the procedure in [After working inside your computer](#).

## Power button with optional fingerprint reader

### Removing the power-button with optional fingerprint reader

#### Prerequisites

1. Follow the procedure in [Before working inside your computer](#).
2. Remove the [base cover](#).
3. Remove the [I/O board](#).

#### About this task

The following image(s) indicate the location of the power-button with optional fingerprint reader and provides a visual representation of the removal procedure.



1x  
M2x3

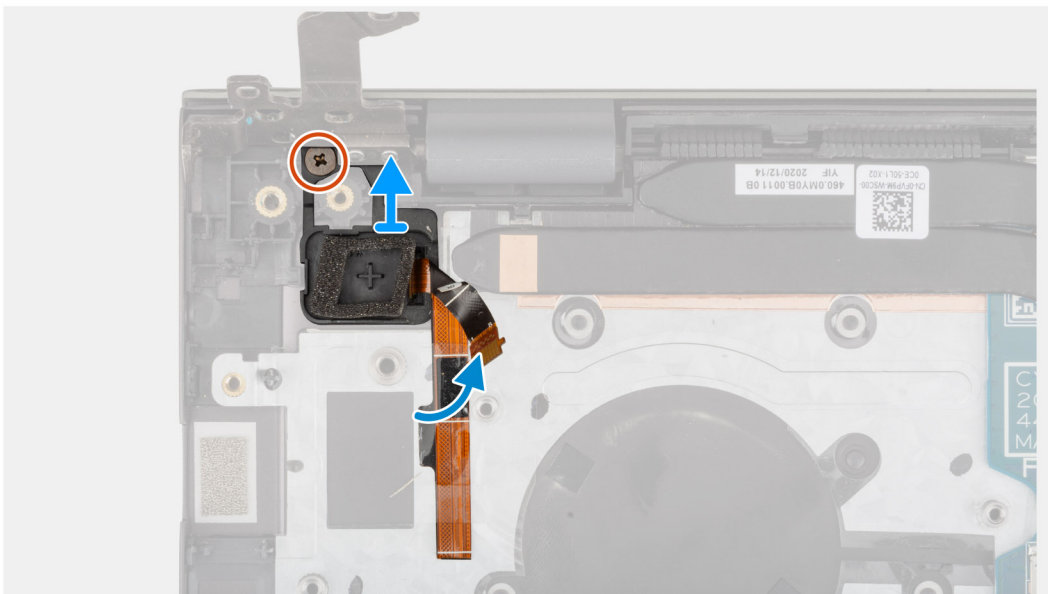

#### Steps

1. Remove the screw (M2x3) that secures the power-button with optional fingerprint reader off the palm-rest and keyboard assembly.
2. Lift the power-button with optional fingerprint reader off the palm-rest and keyboard assembly.



# Installing the power-button with optional fingerprint reader

## Prerequisites

If you are replacing a component, remove the existing component before performing the installation process.

## About this task

The following image(s) indicate the location of the power-button with optional fingerprint reader and provides a visual representation of the installation procedure.



1x  
M2x3

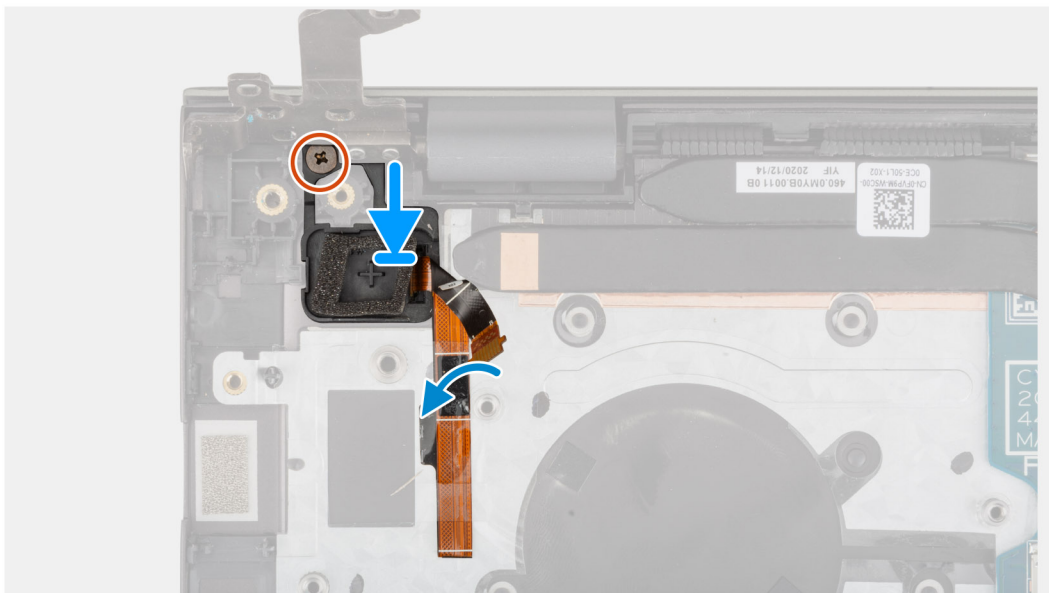

## Steps

1. Using the alignment posts, place the power-button with optional fingerprint reader into its slot on the palm-rest and keyboard assembly.
2. Replace the screw (M2x3) that secures the power-button with optional fingerprint reader to the palm-rest and keyboard assembly.

## Next steps

1. Install the [I/O board](#).
2. Install the [base cover](#).
3. Follow the procedure in [After working inside your computer](#).

# Power-adapter port

## Removing the power-adapter port

### Prerequisites

1. Follow the procedure in [Before working inside your computer](#).
2. Remove the [base cover](#).

### About this task

The following image(s) indicate the location of the power-adapter port and provides a visual representation of the removal procedure.



2x  
M2.5x5

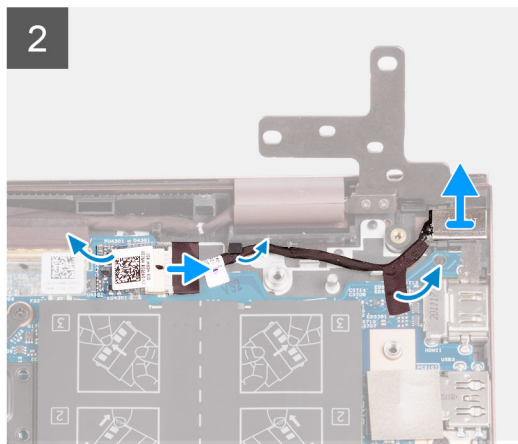
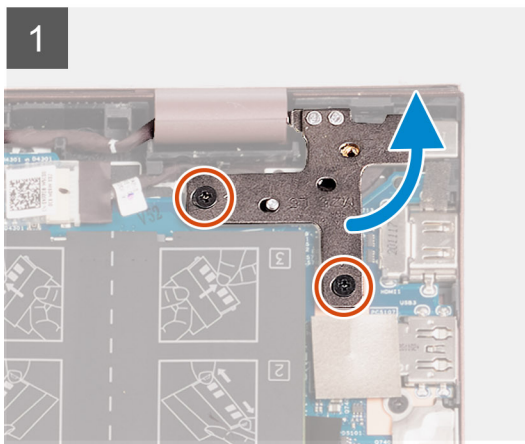
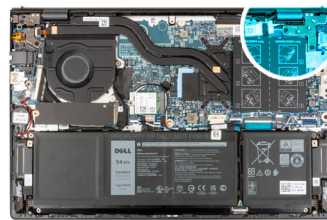

### Steps

1. Remove the two screws (M2.5x5) that secures the right-display hinge to the system board.
2. Pry open the right-display hinge at an angle of 90 degrees.
3. Peel the tape that covers the power-adapter port connector on the system board.
4. Disconnect the power-adapter port from the system board.
5. Remove the power-adapter port cable from the routing guides on the palm-rest and keyboard assembly.
6. Remove the power-adapter port from the palm-rest and keyboard assembly.

## Installing the power-adapter port

### Prerequisites

If you are replacing a component, remove the existing component before performing the installation process.

### About this task

The following image(s) indicate the location of the power-adapter port and provides a visual representation of the installation procedure.



2x  
M2.5x5

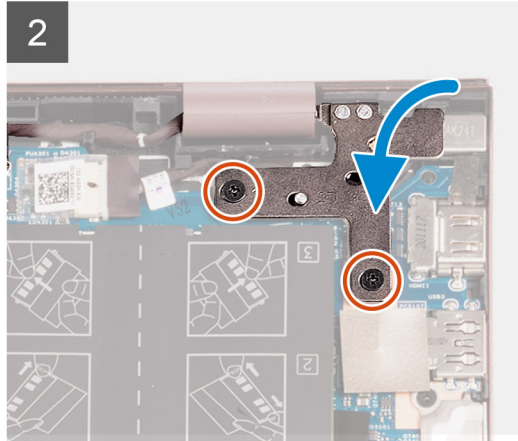
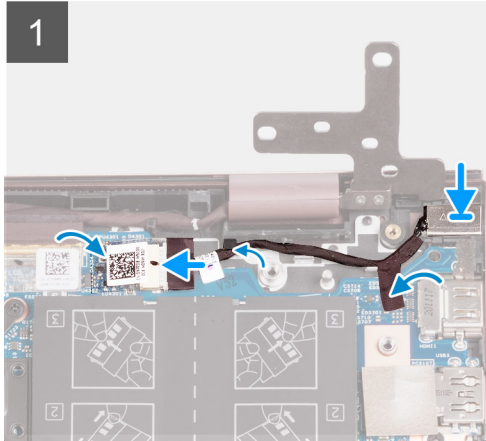
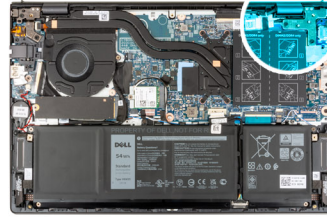

### Steps

1. Connect the power-adaptor port cable to the system board.
2. Adhere the tape that covers the power-adaptor port connector on the system board.
3. Route the power-adaptor port cable through the routing guides on the palm-rest and keyboard assembly.
4. Place the power-adaptor port into the slot on the palm-rest and keyboard assembly.
5. Close the right-display hinge and align the screw holes on the right-display hinge with the screw holes on the system board.
6. Replace the two screws (M2.5x5) that secures the right-display hinge to the system board.

### Next steps

1. Install the [base cover](#).
2. Follow the procedure in [After working inside your computer](#).

## System board

### Removing the system board

#### Prerequisites

1. Follow the procedure in [Before working inside your computer](#).
2. Remove the [base cover](#).
3. Remove the [3-cell battery](#) or the [4-cell battery](#), whichever applicable.
4. Remove the [M.2 2230 solid-state drive](#).
5. Remove the [M.2 2280 solid-state drive](#).
6. Remove the [memory](#).
7. Remove the [wireless card](#).
8. Remove the [heat sink](#).

#### About this task

The following image indicates the connectors on your system board.

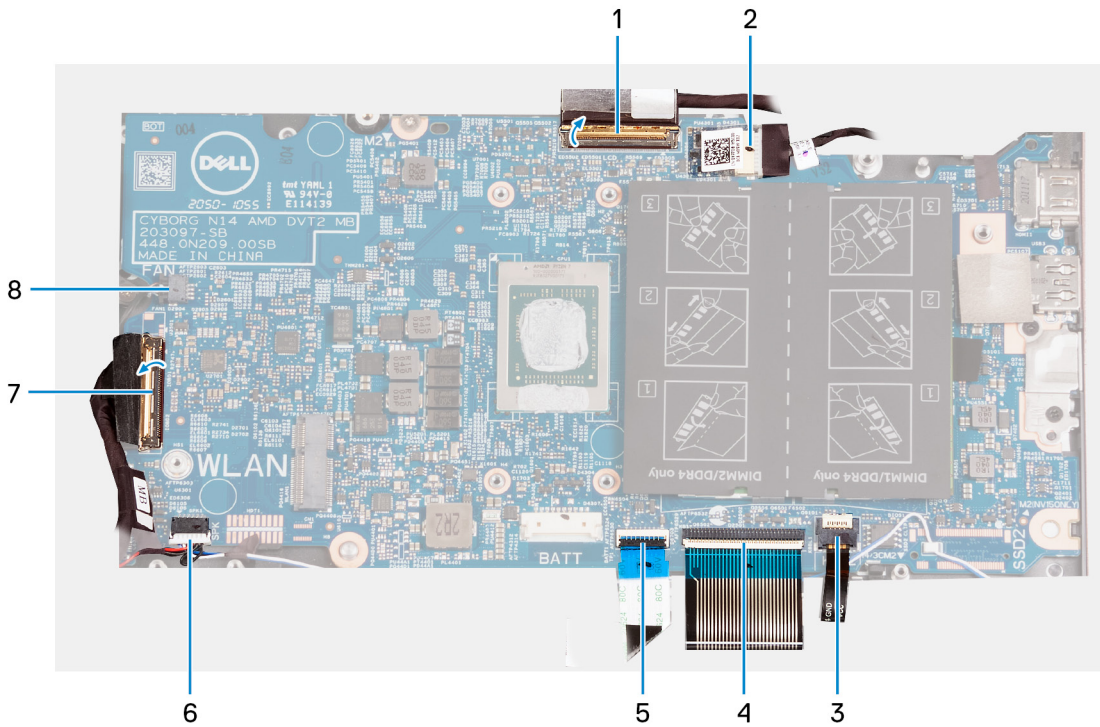

1. display cable
2. power-adaptor port-cable
3. keyboard-backlight cable
4. keyboard cable
5. touchpad cable
6. speaker cable
7. I/O-board cable
8. fan cable

The following image(s) indicate the location of the system board and provides a visual representation of the removal procedure.

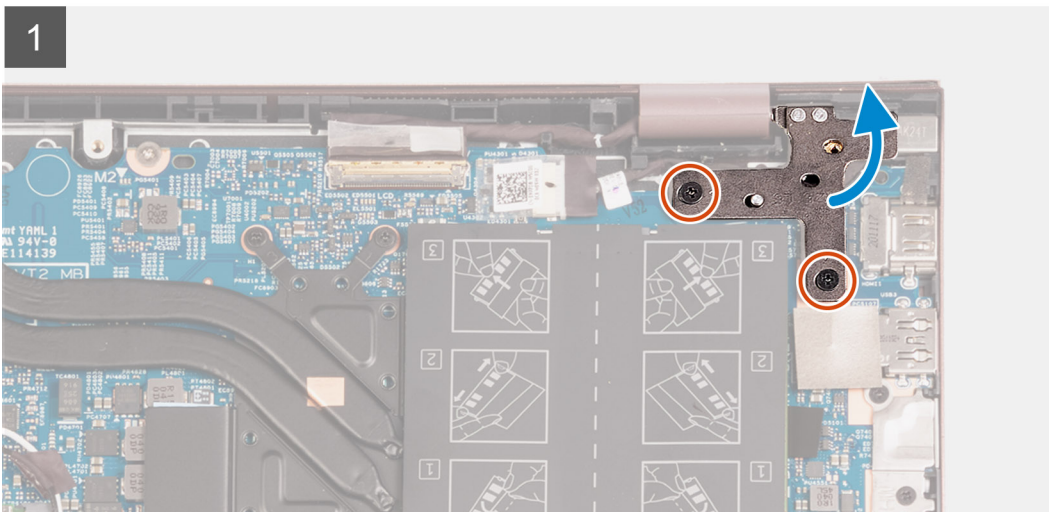

2

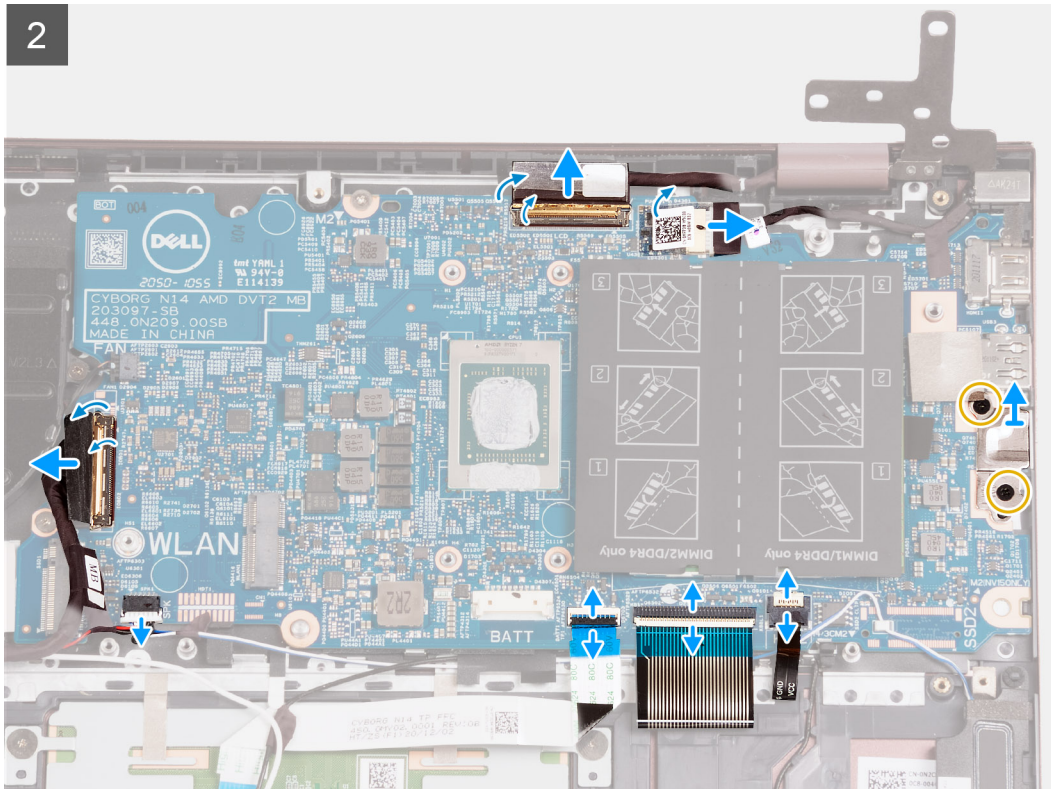

3

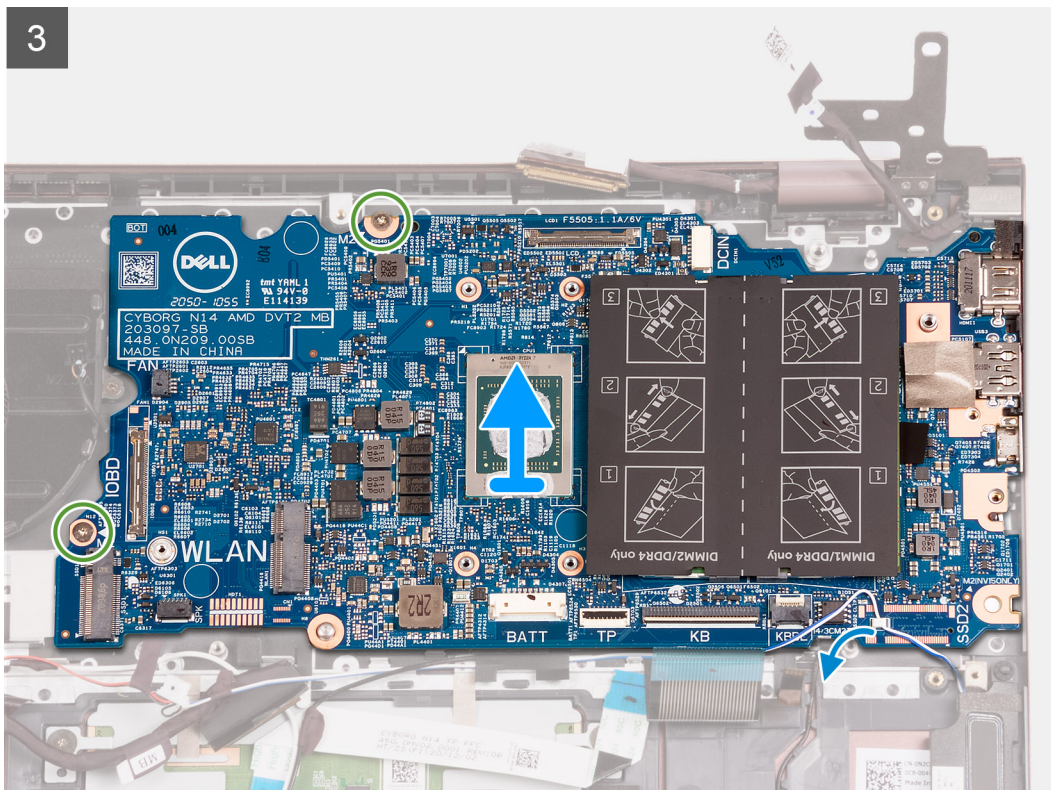

### Steps

1. Remove the two screws (M2.5x5) that secure the right-display hinge to the system board.
2. Pry open the right-display hinge at an angle of 90 degrees.
3. Peel the tape that covers the power-adaptor port cable-connector on the system board.
4. Disconnect the power-adaptor port cable from the system board.
5. Peel the tape that secures the display-cable connector latch to the system board.

6. Lift the latch and disconnect the display-cable from the connector on the system board.
7. Disconnect the fan cable from the system board.
8. Lift the I/O-board cable-connector latch and disconnect the I/O-board cable from the system board.
9. Disconnect the speaker cable from the system board.
10. Lift the latch and disconnect the touchpad cable from the system board.
11. Lift the latch and disconnect the keyboard cable from the system board.
12. Lift the latch and disconnect the keyboard-backlight cable from the system board.

**NOTE:** This step is only applicable for computers installed with a backlit keyboard.

13. Remove the two screws (M2x4) that secure the Type-C port-bracket to the system board.
14. Lift the Type-C port-bracket off the system board.
15. Remove the two screws (M2x2) that secure the system board to the palm-rest and keyboard assembly.
16. Lift the system board from the palm-rest and keyboard assembly.

## Installing the system board

### Prerequisites

If you are replacing a component, remove the existing component before performing the installation process.

### About this task

The following image indicates the connectors on your system board.

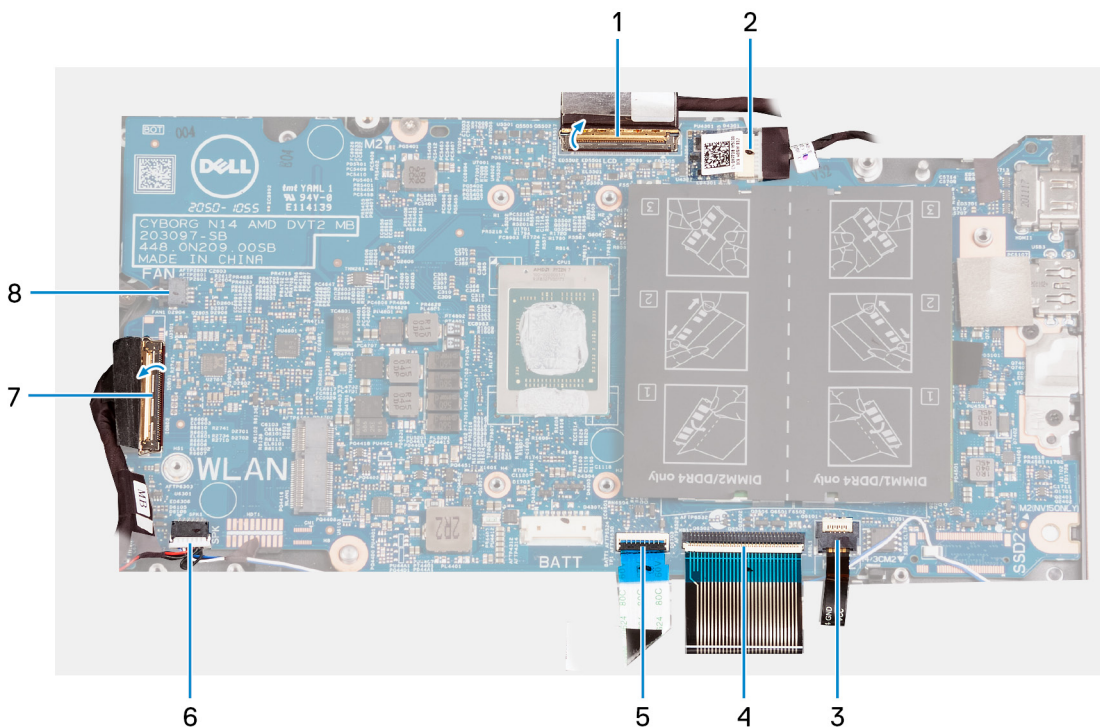

1. display cable
2. power-adaptor port-cable
3. keyboard-backlight cable
4. keyboard cable
5. touchpad cable
6. speaker cable
7. I/O-board cable
8. fan cable

The following image(s) indicate the location of the system board and provides a visual representation of the installation procedure.

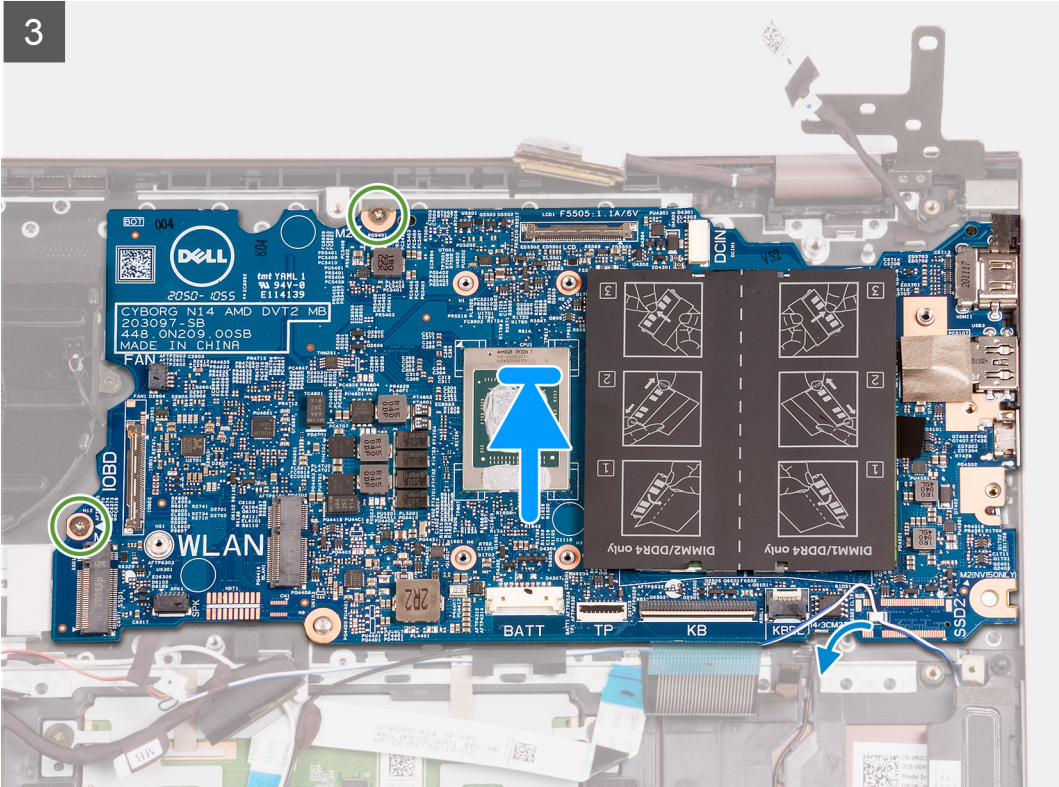

2

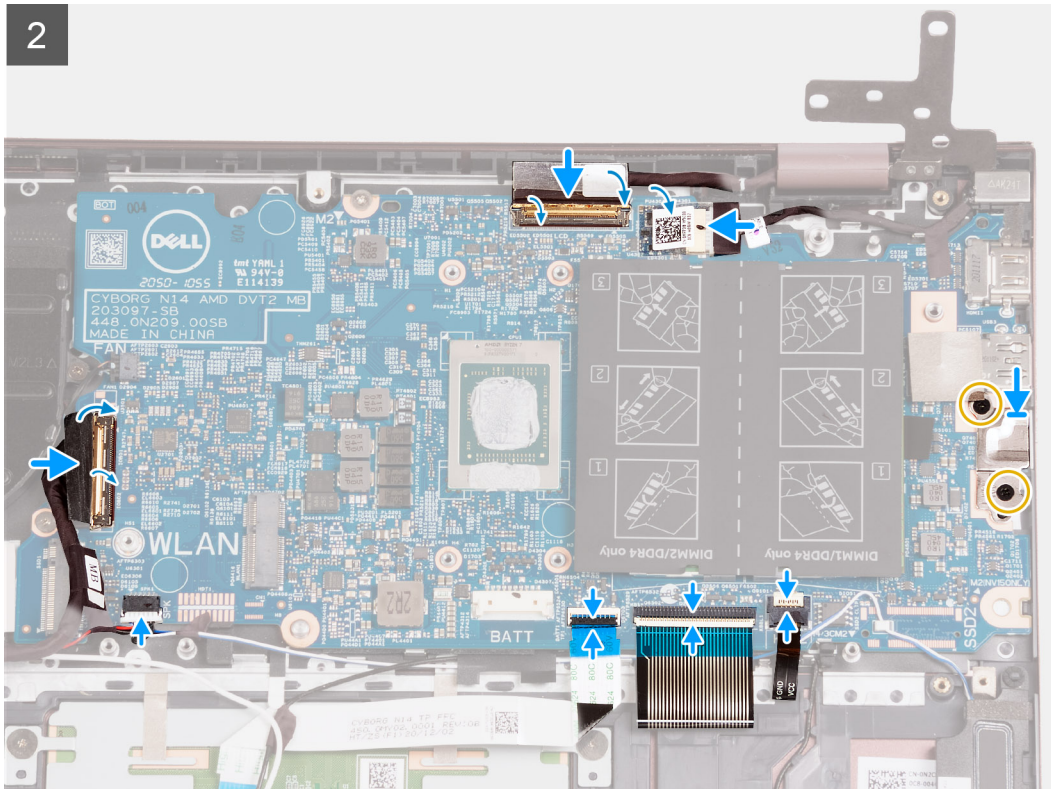

3

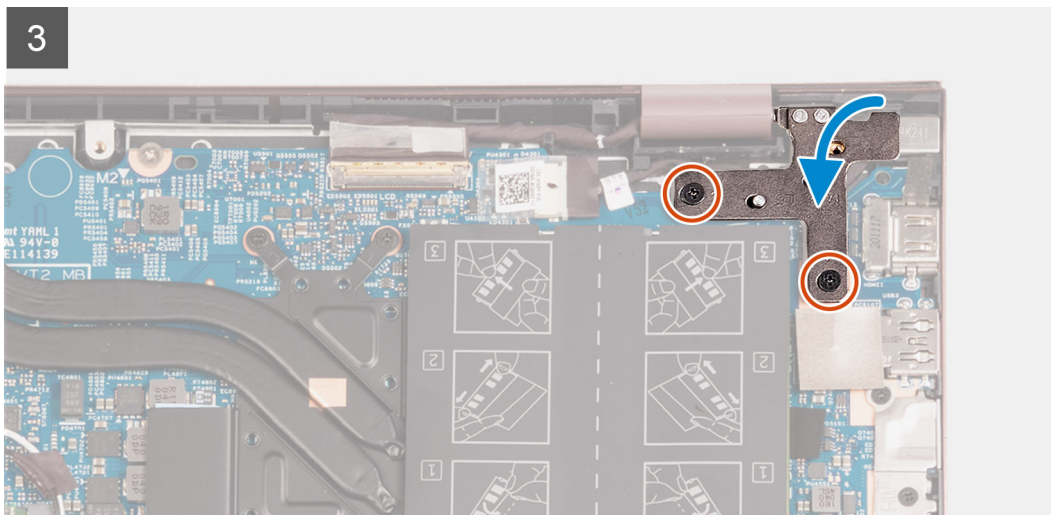

### Steps

1. Place the system board on the palm-rest and keyboard assembly.
2. Align the screw holes on the system board with the screw holes on the palm-rest and keyboard assembly.
3. Replace the two screws (M2x2) that secure the system board to the palm-rest and keyboard assembly.
4. Place the Type-C port-bracket on the system board.
5. Replace the two screws (M2x4) that secure the Type-C port-bracket to the system board.
6. Connect the keyboard-backlight cable to the connector on the system board and close the latch.

**NOTE:** This step is only applicable if you are installing a backlit keyboard on your computer.

7. Connect the keyboard cable to the connector on the system board and close the latch.
8. Connect the touchpad cable to the connector on the system board and close the latch.
9. Connect the speaker cable to the system board.
10. Connect the I/O-board cable to the connector on the system board and close the latch.



11. Connect the fan cable to the system board.
12. Connect the display cable to the connector on the system board and close the latch.
13. Adhere the tape that secures the display-cable connector latch to the system board.
14. Connect the power-adaptor port cable to the system board,
15. Adhere the tape that covers the power-adaptor cable-connector on the system board.
16. Close the right-display hinge and align the screw holes on the right-display hinge with the screw holes on the system board.
17. Replace the two screws (M2.5x5) that secure the right-display hinge to the system board.

### Next steps

1. Install the [heat sink](#).
2. Install the [wireless card](#).
3. Install the [memory](#).
4. Install the [M.2 2280 solid-state drive](#).
5. Install the [M.2 2230 solid-state drive](#).
6. Install the [3-cell battery](#) or the [4-cell battery](#), whichever applicable.
7. Install the [base cover](#).
8. Follow the procedure in [After working inside your computer](#).

## Palm-rest and keyboard assembly

### Removing the palm-rest and keyboard assembly

#### Prerequisites

1. Follow the procedure in [Before working inside your computer](#).
2. Remove the [base cover](#).
3. Remove the [3-cell battery](#) or the [4-cell battery](#), whichever applicable.
4. Remove the [coin-cell battery](#).
5. Remove the [M.2 2230 solid-state drive](#).
6. Remove the [M.2 2280 solid-state drive](#).
7. Remove the [wireless card](#).
8. Remove the [power-adaptor port](#).
9. Remove the [I/O board](#).
10. Remove the [speakers](#).
11. Remove the [touchpad](#).
12. Remove the [fan](#).
13. Remove the [display assembly](#).
14. Remove the [power-button with optional fingerprint reader](#).
15. Remove the [system board](#).

 **NOTE:** The system board can be removed with the heat sink and solid-state drives attached.

#### About this task

The following image(s) indicate the location of the palm-rest and keyboard assembly and provides a visual representation of the removal procedure.

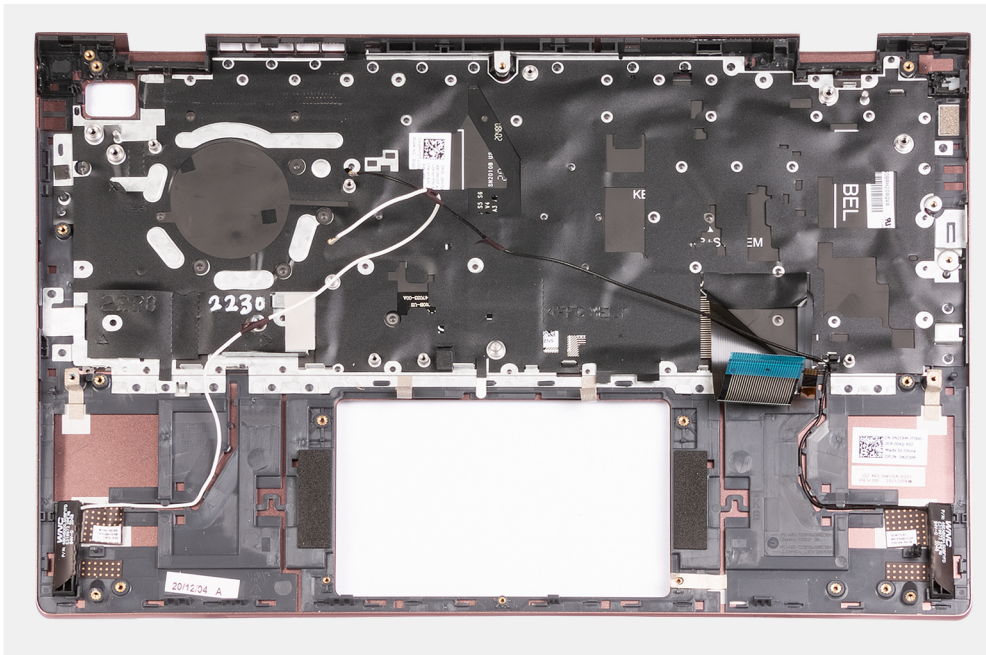

### Steps

After performing the pre-requisites you are left with the palm-rest and keyboard assembly.

## Installing the palm-rest and keyboard assembly

### Prerequisites

If you are replacing a component, remove the existing component before performing the installation process.

### About this task

The following image(s) indicate the location of the palm-rest and keyboard assembly and provides a visual representation of the installation procedure.

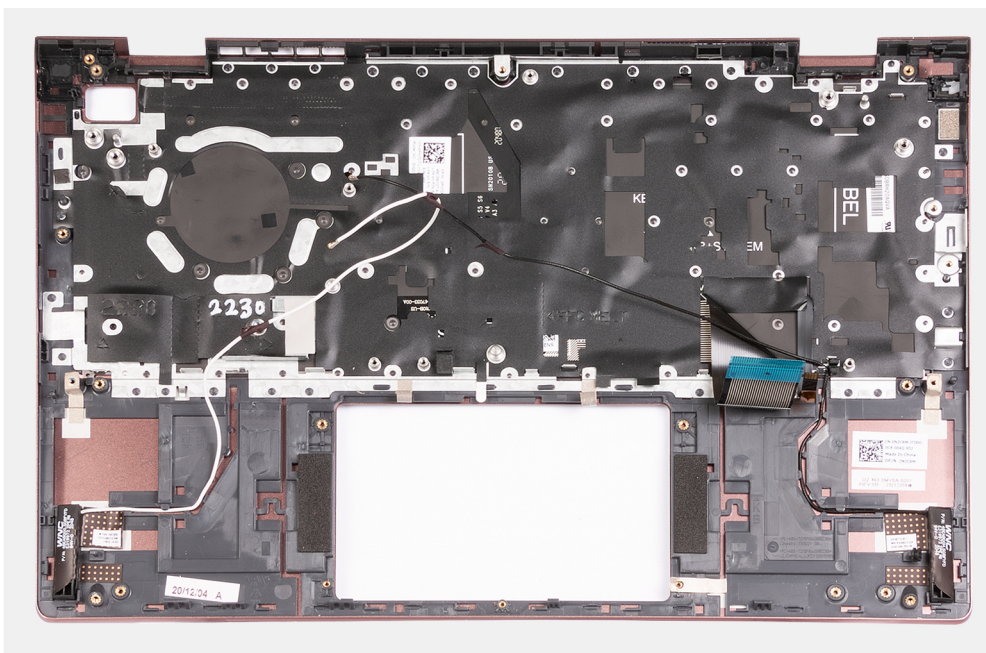

## Steps

Place the palm-rest and keyboard assembly on a flat and clean surface and perform the post-requisites to install the palm-rest and keyboard assembly.

## Next steps

1. Install the [system board](#).
2. Install the [power-button with optional fingerprint reader](#).
3. Install the [display assembly](#).
4. Install the [fan](#).
5. Install the [touchpad](#).
6. Install the [speakers](#).
7. Install the [I/O board](#).
8. Install the [power-adaptor port](#).
9. Install the [wireless card](#).
10. Install the [M.2 2280 solid-state drive](#).
11. Install the [M.2 2230 solid-state drive](#).
12. Install the [coin-cell battery](#).
13. Install the [3-cell battery](#) or the [4-cell battery](#), whichever applicable.
14. Install the [base cover](#).
15. Follow the procedure in [After working inside your computer](#).

## Drivers and downloads

When troubleshooting, downloading or installing drivers it is recommended that you read the Dell Knowledge Based article, Drivers and Downloads FAQ [SLN128938](#).

# System setup

**CAUTION:** Unless you are an expert computer user, do not change the settings in the BIOS Setup program. Certain changes can make your computer work incorrectly.

**NOTE:** Before you change BIOS Setup program, it is recommended that you write down the BIOS Setup program screen information for future reference.

Use the BIOS Setup program for the following purposes:

- Get information about the hardware installed in your computer, such as the amount of RAM and the size of the hard drive.
- Change the system configuration information.
- Set or change a user-selectable option, such as the user password, type of hard drive installed, and enabling or disabling base devices.

## Topics:

- [BIOS overview](#)
- [Entering BIOS setup program](#)
- [Navigation keys](#)
- [Boot Sequence](#)
- [System setup options](#)
- [System and admin password](#)
- [Clearing BIOS \(System Setup\) and System passwords](#)

## BIOS overview

The BIOS manages data flow between the computer's operating system and attached devices such as hard disk, video adapter, keyboard, mouse, and printer.

## Entering BIOS setup program

### About this task

Turn on (or restart) your computer and press F2 immediately.

## Navigation keys

**NOTE:** For most of the System Setup options, changes that you make are recorded but do not take effect until you restart the system.

Keys	Navigation
<b>Up arrow</b>	Moves to the previous field.
<b>Down arrow</b>	Moves to the next field.
<b>Enter</b>	Selects a value in the selected field (if applicable) or follow the link in the field.
<b>Spacebar</b>	Expands or collapses a drop-down list, if applicable.
<b>Tab</b>	Moves to the next focus area.
<b>Esc</b>	Moves to the previous page until you view the main screen. Pressing Esc in the main screen displays a message that prompts you to save any unsaved changes and restarts the system.

# Boot Sequence

Boot sequence enables you to bypass the System Setup–defined boot device order and boot directly to a specific device (for example: optical drive or hard drive). During the Power-on Self-Test (POST), when the Dell logo appears, you can:

- Access System Setup by pressing F2 key
- Bring up the one-time boot menu by pressing F12 key.

The one-time boot menu displays the devices that you can boot from including the diagnostic option. The boot menu options are:

UEFI only:

- Windows Boot Manager
- UEFI RST KXG60ZNV512G NVMe KIOXIA 512 GB 40NA83SKJ81L

The boot sequence screen also displays the option to access the System Setup screen.

# System setup options

**NOTE:** Depending on this computer and its installed devices, the items that are listed in this section may or may not be displayed.

**Table 3. System setup options—Main menu**

Main	
<b>System Time</b>	Displays the current system time of the computer in HH/MM/SS format.
<b>System Date</b>	Displays the ownership date of the computer in MM/DD/YYYY format.
<b>BIOS Version</b>	Displays the BIOS version of the computer.
<b>Product Name</b>	Displays the system model name of the computer.
<b>Service Tag</b>	Displays the service tag of the computer.
<b>Asset Tag</b>	Displays the asset tag of the computer.
<b>CPU Type</b>	Displays the processor type.
<b>CPU Speed</b>	Displays the maximum processor clock speed.
<b>CPU ID</b>	Displays the processor identification code.
<b>CPU Cache</b>	
<b>L1 Cache</b>	Displays the processor L1 Cache size.
<b>L2 Cache</b>	Displays the processor L2 Cache size.
<b>L3 Cache</b>	Displays the processor L3 Cache size.
<b>M.2 PCIe SSD</b>	Displays the PCIe SSD information connected to the M.2 slot.
<b>AC Adapter Type</b>	Displays whether an AC adapter is installed.
<b>System Memory</b>	Displays the total computer memory installed.
<b>Memory Speed</b>	Displays the memory speed.
<b>Keyboard Type</b>	Displays the type of the keyboard (option could be backlit or non-backlit).

**Table 4. System setup options—Advance menu**

Advance	
<b>Virtualization</b>	Specify whether a Virtual Machine Monitor (VMM) can utilize the additional hardware capabilities provided by Onboard Virtualization Technology.  Options are:

**Table 4. System setup options—Advance menu**

Advance	
	<ul style="list-style-type: none"> <li>• Enabled (Default)</li> <li>• Disabled</li> </ul>
<b>Integrated NIC</b>	<p>Allows pre-OS and early OS networking features to use any enabled NICs.</p> <p>Options are:</p> <ul style="list-style-type: none"> <li>• Enabled (Default)</li> <li>• Disabled</li> </ul>
<b>USB Emulation</b>	<p>Allows to enable USB emulation.</p> <p>Options are:</p> <ul style="list-style-type: none"> <li>• Enabled (Default)</li> <li>• Disabled</li> </ul>
<b>SATA Operation</b>	<p>Allows to select the SATA mode of the computer. Option is set to AHCI.</p>
<b>Adapter Warnings</b>	<p>Displays Adapter Warning during the POST when Battery Level is Critically low.</p> <p>Options are:</p> <ul style="list-style-type: none"> <li>• Enabled (Default)</li> <li>• Disabled</li> </ul>
<b>Function Key Behavior</b>	<p>Allows to reverse Function Key Primary behavior with secondary.</p> <p>Options are:</p> <ul style="list-style-type: none"> <li>• Multimedia Key(Default)</li> <li>• Function Key</li> </ul>
<b>Keyboard Illumination</b>	<p>Allows to Switch-on/switch-off the Keyboard backlight.</p> <p>Options are:</p> <ul style="list-style-type: none"> <li>• Disable</li> <li>• Dim</li> <li>• Bright (Default)</li> </ul>
<b>Keyboard Backlight with AC</b>	<p>Allows to permanently turn off/turn-on the Keyboard backlight without the AC adapter.</p> <p>Options are from 5 Seconds to 15 Minutes. Default option is set to 1 Minute.</p>
<b>Keyboard Backlight with Battery</b>	<p>Allows to permanently turn off/turn-on the Keyboard backlight without the AC adapter.</p> <p>Options are from 5 Seconds to 15 Minutes. Default option is set to 1 Minute.</p>
<b>Battery Health</b>	<p>Shows Battery Health and Charge Status.</p>
<b>External USB Ports</b>	<p>Allows to turn off the External USB ports in the Operating System.</p> <p>Options are:</p> <ul style="list-style-type: none"> <li>• Enabled (Default)</li> <li>• Disabled</li> </ul>
<b>Microphone</b>	<p>Allows to Switch-on/switch-off the microphone.</p> <p>Options are:</p> <ul style="list-style-type: none"> <li>• Enabled (Default)</li> <li>• Disabled</li> </ul>
<b>Camera</b>	<p>Allows to Switch-on/switch-off the Camera.</p> <p>Options are:</p> <ul style="list-style-type: none"> <li>• Enabled (Default)</li> <li>• Disabled</li> </ul>

**Table 4. System setup options—Advance menu (continued)**

Advance	
<b>Internal Bluetooth</b>	Allows to Switch-on/switch-off the Bluetooth. Options are: <ul style="list-style-type: none"> <li>• Enabled (Default)</li> <li>• Disabled</li> </ul>
<b>Internal WLAN</b>	Allows to Switch-on/switch-off the Wireless Card. Options are: <ul style="list-style-type: none"> <li>• Enabled (Default)</li> <li>• Disabled</li> </ul>
<b>Media Card Reader</b>	Allows to enable/disable the Media Card reader. Options are: <ul style="list-style-type: none"> <li>• Enabled (Default)</li> <li>• Disabled</li> </ul>
<b>Fingerprint Reader</b>	Allows to enable/disable the Fingerprint reader. Options are: <ul style="list-style-type: none"> <li>• Enabled (Default)</li> <li>• Disabled</li> </ul>
<b>Boot Disable</b>	Disable the automatic Boot. Options are: <ul style="list-style-type: none"> <li>• Enabled</li> <li>• Disabled (Default)</li> </ul>
<b>Battery Charge Configuration</b>	Displays the Battery Charge configuration. Options are: <ul style="list-style-type: none"> <li>• Adaptive (Default)</li> <li>• Standard</li> <li>• ExpressCharge™</li> <li>• Primarily AC Use</li> <li>• Custom</li> </ul>
<b>Advanced Battery Charge Configuration</b>	Displays the Advanced Charge configuration. Options are: <ul style="list-style-type: none"> <li>• Enabled</li> <li>• Disabled (Default)</li> </ul>
<b>Power on LID open</b>	Controls the Power function on LID open action. Options are: <ul style="list-style-type: none"> <li>• Enabled (Default)</li> <li>• Disabled</li> </ul>
<b>Maintenance</b>	Maintenance information.
Data Wipe on next boot	Performs Data wipe on next boot. Options are: <ul style="list-style-type: none"> <li>• Disabled (Default)</li> <li>• Enabled</li> </ul>
BIOS Recovery from Hard Drive	Performs reset of firmware to the factory image saved on the secondary storage. Options are: <ul style="list-style-type: none"> <li>• Enabled (Default)</li> <li>• Disabled</li> </ul>
BIOS Auto Recovery	Performs auto firmware reset when corrupted BIOS is detected. Options are:



**Table 4. System setup options—Advance menu (continued)**

Advance	
	<ul style="list-style-type: none"> <li>• Disabled (Default)</li> <li>• Enabled</li> </ul>
<b>SupportAssist System Resolution</b>	Onboard Diagnostics
Auto OS Recovery Threshold	Performs SupportAssist OS recovery after the set value failed boot attempts. Options are: <ul style="list-style-type: none"> <li>• Off</li> <li>• 1</li> <li>• 2 (Default)</li> <li>• 3</li> </ul>
Support Assist OS Recovery	Enabled Support Assist OS recovery on failed boot attempts. Options are: <ul style="list-style-type: none"> <li>• Disabled</li> <li>• Enabled (Default)</li> </ul>



**Table 5. System setup options—Security menu (continued)**

Security	
Admin Password	Displays the Status of the administrator password.
System Password	Displays the Status of the computer password.
<b>Asset Tag</b>	Displays and allows to edit the Asset Tag of the computer.
<b>Admin Password</b>	Set, change, or delete the administrator password.
<b>System Password</b>	Set, change, or delete the computer password.
<b>Password Change</b>	Set the status to allow User to set the System Password. The options are: <ul style="list-style-type: none"> <li>• Permitted (Default)</li> <li>• Disabled</li> </ul>
<b>Password Bypass</b>	Set the status to allow User to bypass System Password. The options are: <ul style="list-style-type: none"> <li>• Disable (Default)</li> <li>• Reboot Bypass</li> </ul>
<b>Absolute®</b>	Set the Status of the Absolute Module on the computer. The options are: <ul style="list-style-type: none"> <li>• Activate</li> <li>• Deactivate</li> </ul>
<b>Absolute® Status</b>	Displays the Status of the Absolute Module on the computer. The options are: <ul style="list-style-type: none"> <li>• Disabled</li> <li>• Enabled (Default)</li> <li>• Permanently Disabled</li> </ul>
<b>Firmware TPM</b>	Enable or disable TPM 2.0 security options.
<b>TPM Security</b>	TPM 2.0 Security options.
<b>TPM On</b>	Turn On/Off TPM security option. The options are: <ul style="list-style-type: none"> <li>• On</li> <li>• Off</li> </ul>
<b>PPI Bypass for Enable Commands</b>	Controls the TPM Physical Presence Interface(PPI). When enabled, this setting allows the OS to skip BIOS PPI user prompts when issuing TPM PPI enable and activate commands. The Options are: <ul style="list-style-type: none"> <li>• Enabled</li> <li>• Disabled (Default)</li> </ul>
<b>PPI Bypass for Disable Commands</b>	Controls the TPM Physical Presence Interface(PPI). When enabled, this setting will allow the OS to skip BIOS PPI user prompts when issuing TPM PPI disable and deactivate commands(#2, 4, 7, 9, & 11). The options are:

**Table 5. System setup options—Security menu**

Security	
	<ul style="list-style-type: none"> <li>• Disabled (Default)</li> <li>• Enabled</li> </ul>
<b>Attestation Enable</b>	<p>Provides for the user to control whether the TPM Endorsement Hierarchy is available to the OS. The options are:</p> <ul style="list-style-type: none"> <li>• Disabled</li> <li>• Enabled (Default)</li> </ul>
<b>Key Storage Enable</b>	<p>Provides for the user to control whether TPM Storage Hierarchy is available to the operating system. The options are:</p> <ul style="list-style-type: none"> <li>• Disabled</li> <li>• Enabled (Default)</li> </ul>
<b>SHA-256</b>	<p>Provides the BIOS and the TPM to use the SHA-256 hash algorithm to extend measurements into the TPM PCRs during BIOS boot. The options are:</p> <ul style="list-style-type: none"> <li>• Disabled</li> <li>• Enabled (Default)</li> </ul>
<b>Clear</b>	<p>Clears the TPM owner information, and returns the TPM to the default state. The options are:</p> <ul style="list-style-type: none"> <li>• Disabled (Default)</li> <li>• Enabled</li> </ul>
<b>PPI Bypass for Clear Commands</b>	<p>Controls the TPM Physical Presence Interface(PPI). When enabled, this setting will allow the OS to skip BIOS PPI user prompts when issuing the Clear command. The options are:</p> <ul style="list-style-type: none"> <li>• Disabled (Default)</li> <li>• Enabled</li> </ul>
<b>TPM Status</b>	<p>Displays the Status of the TPM Module on the computer. The options are:</p> <ul style="list-style-type: none"> <li>• Disabled</li> <li>• Enabled (Default)</li> </ul>
<b>UEFI Firmware Capsule Updates</b>	<p>Enable or disable BIOS updates through UEFI capsule update packages. By default, the option is enabled.</p>
<b>Secure Boot</b>	<p>Ensures the system boots using only to validated boot software.</p>

**Table 6. System setup options—Boot menu**

Boot	
<b>File Browser Add Boot Option</b>	
<b>Windows Boot Manager:</b>	<p>Displays the Default UEFI Boot Path of the computer Operating System and allows to navigate and select the EFI file.</p> <p> <b>NOTE:</b> Option may differ with the Linux Operating System.</p>
<b>File Browser Del Boot Option</b>	
<b>Windows Boot Manager:</b>	<p>Displays the Dell Boot Path of the Default Boot Option..</p> <p> <b>NOTE:</b> Option may differ with the Linux Operating System.</p>
<b>UEFI BOOT</b>	
<b>HDD1- Windows Boot Manager</b>	<p>Displays the Device ID of the Secondary Storage of the computer.</p>
<b>UEFI Onboard LAN IPv4</b>	<p>Displays the Device ID of the UEFI enabled Onboard IPv4 LAN controller.</p>
<b>UEFI Onboard LAN IPv6</b>	<p>Displays the Device ID of the UEFI enabled Onboard IPv6 LAN controller.</p>

**Table 7. System setup options—Exit menu**

**Table 7. System setup options—Exit menu**

Exit	
<b>Exit Saving Changes</b>	Exit the System Setup saving the changes made to the Setup Options.
<b>Save Change Without Exit</b>	Save the Changes made to the System Setup and continue the Setup.
<b>Exit Discarding Changes</b>	Exit the System Setup without saving the changes made to the Setup Options.
<b>Load Optional Defaults</b>	Load the Factory Defaults in the System Setup Options.
<b>Discard Changes</b>	Discard any changes made to the System Setup and continue the Setup.

## System and admin password

**Table 8. System and admin password**

Password type	Description
System password	Password that you must enter to log on to your system.
Admin password	Password that you must enter to access and make changes to the BIOS settings of your computer.

You can create a system password and a admin password to secure your computer.

 **CAUTION:** The password features provide a basic level of security for the data on your computer.

 **CAUTION:** Anyone can access the data stored on your computer if it is not locked and left unattended.

 **NOTE:** System and admin password feature is disabled as factory default setting.

## Assigning a system setup password

### Prerequisites

You can assign a new **System or Admin Password** only when the status is in **Not Set**.

### About this task

To enter the system setup, press F2 immediately after a power-on or reboot.

### Steps

1. In the **System BIOS** or **System Setup** screen, select **Security** and press **Enter**.  
The **Security** screen is displayed.
2. Select **System/Admin Password** and create a password in the **Enter the new password** field.  
Use the following guidelines to assign the system password:
  - A password can have up to 32 characters.
  - The password can contain the numbers 0 through 9.
  - Only lower case letters are valid, upper case letters are not allowed.
  - Only the following special characters are allowed: space, ("), (+), (.), (-), (.), (/), (:), ([], (\), (]), (`).
3. Type the system password that you entered earlier in the **Confirm new password** field and click **OK**.
4. Press **Esc** and a message prompts you to save the changes.
5. Press **Y** to save the changes.  
The computer reboots.

# Deleting or changing an existing system setup password

## Prerequisites

Ensure that the **Password Status** is Unlocked (in the System Setup) before attempting to delete or change the existing System and Setup password. You cannot delete or change an existing System or Setup password, if the **Password Status** is Locked.

## About this task

To enter the System Setup, press **F2** immediately after a power-on or reboot.

## Steps

1. In the **System BIOS** or **System Setup** screen, select **System Security** and press **Enter**.  
The **System Security** screen is displayed.
2. In the **System Security** screen, verify that **Password Status** is **Unlocked**.
3. Select **System Password**, alter or delete the existing system password and press **Enter** or **Tab**.
4. Select **Setup Password**, alter or delete the existing setup password and press **Enter** or **Tab**.  
 **NOTE:** If you change the System and/or Setup password, re enter the new password when prompted. If you delete the System and Setup password, confirm the deletion when prompted.
5. Press **Esc** and a message prompts you to save the changes.
6. Press **Y** to save the changes and exit from System Setup.  
The computer restarts.

# Clearing BIOS (System Setup) and System passwords

## About this task

 **NOTE:** To conduct a BIOS and System password reset, you must call the Dell Tech Support number in your region.

## Steps

1. Key in your computer's service tag number into the locked BIOS/system setup screen.
2. Convey the code generated to the Dell Tech Support agent.
3. The Dell Tech Support agent will provide a 32 character Master System Password that can be used to access the locked BIO/system setup.

# Troubleshooting

## Topics:

- [Dell SupportAssist Pre-boot System Performance Check diagnostics](#)
- [System diagnostic lights](#)
- [Recovering the operating system](#)
- [Flashing BIOS \(USB key\)](#)
- [Flashing the BIOS](#)
- [M-BIST](#)
- [LCD Built-in Self Test \(BIST\)](#)
- [WiFi power cycle](#)
- [Flea power release](#)

## Dell SupportAssist Pre-boot System Performance Check diagnostics

### About this task

SupportAssist diagnostics (also known as system diagnostics) performs a complete check of your hardware. The Dell SupportAssist Pre-boot System Performance Check diagnostics is embedded with the BIOS and is launched by the BIOS internally. The embedded system diagnostics provides a set of options for particular devices or device groups allowing you to:

- Run tests automatically or in an interactive mode
- Repeat tests
- Display or save test results
- Run thorough tests to introduce additional test options to provide extra information about the failed device(s)
- View status messages that inform you if tests are completed successfully
- View error messages that inform you of problems encountered during testing

 **NOTE:** Some tests for specific devices require user interaction. Always ensure that you are present at the computer terminal when the diagnostic tests are performed.

For more information, see [Resolve Hardware Issues With Built-in and Online Diagnostics \(SupportAssist ePSA, ePSA or PSA Error Codes\)](#).

## Running the SupportAssist Pre-Boot System Performance Check

### Steps

1. Turn on your computer.
2. As the computer boots, press the F12 key as the Dell logo appears.
3. On the boot menu screen, select the **Diagnostics** option.
4. Click the arrow at the bottom left corner.  
Diagnostics front page is displayed.
5. Click the arrow in the lower-right corner to go to the page listing.  
The items detected are listed.
6. To run a diagnostic test on a specific device, press Esc and click **Yes** to stop the diagnostic test.
7. Select the device from the left pane and click **Run Tests**.
8. If there are any issues, error codes are displayed.  
Note the error code and validation number and contact Dell.

# System diagnostic lights

## Battery-status light

Indicates the power and battery-charge status.

**Solid white** — Power adapter is connected and the battery has more than 5 percent charge.

**Amber** — Computer is running on battery and the battery has less than 5 percent charge.

**Off** — Discharging or other power states

- Power adapter is connected and the battery is fully charged.
- Computer is running on battery and the battery has more than 5 percent charge.
- Computer is in sleep state, hibernation, discharging, or turned off.

The power and battery-status light blinks amber along with beep codes indicating failures.

For example, the power and battery-status light blinks amber two times followed by a pause, and then blinks white three times followed by a pause. This 2,3 pattern continues until the computer is turned off indicating no memory or RAM is detected.

The following table shows different power and battery-status light patterns and associated problems.

Blinking Pattern		Problem description	Suggested resolution
2	1	CPU failure	Run the Intel CPU diagnostics tools. If problem persists, replace the system board.
2	2	System Board failure (included BIOS corruption or ROM error)	Flash latest BIOS version. If problem persists, replace the system board.
2	3	No Memory / RAM detected	Confirm that the memory module is installed properly. If problem persists, replace the memory module.
2	4	Memory / RAM failure	Reset and swap memory modules amongst the slots. If problem persists, replace the memory module.
2	5	Invalid memory installed	Reset and swap memory modules amongst the slots. If problem persists, replace the memory module.
2	6	System board / Chipset Error	Replace the system board.
2	7	LCD failure (SBIOS message)	Replace the LCD module.
2	8	LCD failure (EC detection of power rail failure)	Replace the system board.
3	1	CMOS battery failure	Reset the CMOS battery connection. If problem persists, replace the RTC battery.
3	2	PCI or Video card/chip failure	Replace the system board.
3	3	BIOS recovery image not found	Flash latest BIOS version. If problem persists, replace the system board.
3	4	BIOS recovery image found but invalid	Flash latest BIOS version. If problem persists, replace the system board.
3	5	Power rail failure	Replace the system board.

Blinking Pattern		Problem description	Suggested resolution
3	6	Flash corruption detected by SBIOS.	Replace the system board.

**Camera status light:** Indicates whether the camera is in use.

- Solid white — Camera is in use.
- Off — Camera is not in use.

**Caps Lock status light:** Indicates whether Caps Lock is enabled or disabled.

- Solid white — Caps Lock enabled.
- Off — Caps Lock disabled.

## Recovering the operating system

When your computer is unable to boot to the operating system even after repeated attempts, it automatically starts Dell SupportAssist OS Recovery.

Dell SupportAssist OS Recovery is a standalone tool that is preinstalled in all Dell computers installed with Windows 10 operating system. It consists of tools to diagnose and troubleshoot issues that may occur before your computer boots to the operating system. It enables you to diagnose hardware issues, repair your computer, back up your files, or restore your computer to its factory state.

You can also download it from the Dell Support website to troubleshoot and fix your computer when it fails to boot into their primary operating system due to software or hardware failures.

For more information about the Dell SupportAssist OS Recovery, see *Dell SupportAssist OS Recovery User's Guide* at [www.dell.com/support](http://www.dell.com/support).

## Flashing BIOS (USB key)

### Steps

1. Follow the procedure from step 1 to step 7 in "[Flashing the BIOS](#)" to download the latest BIOS setup program file.
2. Create a bootable USB drive. For more information see the knowledge base article [SLN143196](#) at [www.dell.com/support](http://www.dell.com/support).
3. Copy the BIOS setup program file to the bootable USB drive.
4. Connect the bootable USB drive to the computer that needs the BIOS update.
5. Restart the computer and press **F12** when the Dell logo is displayed on the screen.
6. Boot to the USB drive from the **One Time Boot Menu**.
7. Type the BIOS setup program filename and press **Enter**.
8. The **BIOS Update Utility** appears. Follow the instructions on the screen to complete the BIOS update.

## Flashing the BIOS

### About this task

You may need to flash (update) the BIOS when an update is available or when you replace the system board.

Follow these steps to flash the BIOS:

### Steps

1. Turn on your computer.
2. Go to [www.dell.com/support](http://www.dell.com/support).
3. Click **Product support**, enter the Service Tag of your computer, and then click **Submit**.

 **NOTE:** If you do not have the Service Tag, use the auto-detect feature or manually browse for your computer model.

4. Click **Drivers & downloads > Find it myself**.
5. Select the operating system installed on your computer.
6. Scroll down the page and expand **BIOS**.
7. Click **Download** to download the latest version of the BIOS for your computer.
8. After the download is complete, navigate to the folder where you saved the BIOS update file.
9. Double-click the BIOS update file icon and follow the instructions on the screen.

## M-BIST

M-BIST (Built In Self-Test) diagnostics tool, featuring improved accuracy in system board failures.

 **NOTE:** M-BIST can be manually initiated before POST (Power On Self Test).

### How to run M-BIST

 **NOTE:** M-BIST must be initiated on the system from a power-off state either connected to AC power or with battery only.

1. Press and hold both the **M** key on the keyboard and the **power button** to initiate M-BIST.
2. With both the **M** key and the **power button** held down, the battery indicator LED may exhibit two states:
  - a. OFF: No fault detected with the system board
  - b. AMBER: Indicates a problem with the system board

## LCD Built-in Self Test (BIST)

Dell laptops have a built-in diagnostic tool that helps you determine if the screen abnormality you are experiencing is an inherent problem with the LCD (screen) of the Dell laptop or with the video card (GPU) and PC settings.

When you notice screen abnormalities like flickering, distortion, clarity issues, fuzzy or blurry image, horizontal or vertical lines, color fade etc., it is always a good practice to isolate the LCD (screen) by running the Built-In Self Test (BIST).

### How to invoke LCD BIST Test

1. Power off the Dell laptop.
2. Disconnect any peripherals that are connected to the laptop. Connect only the AC adapter (charger) to the laptop.
3. Ensure that the LCD (screen) is clean (no dust particles on the surface of the screen).
4. Press and hold **D** key and **Power on** the laptop to enter LCD built-in self test (BIST) mode. Continue to hold the D key, until you see color bars on the LCD (screen).
5. The screen will display multiple color bars and change colors on the entire screen to red, green, and blue.
6. Carefully inspect the screen for abnormalities.
7. Press **Esc** key to exit.

 **NOTE:** Dell SupportAssist Pre-boot diagnostics upon launch, initiates an LCD BIST first, expecting a user intervention confirm functionality of the LCD.

## WiFi power cycle

### About this task

If your computer is unable to access the internet due to WiFi connectivity issues a WiFi power cycle procedure may be performed. The following procedure provides the instructions on how to conduct a WiFi power cycle:

 **NOTE:** Some ISPs (Internet Service Providers) provide a modem/router combo device.



**Steps**

1. Turn off your computer.
2. Turn off the modem.
3. Turn off the wireless router.
4. Wait for 30 seconds.
5. Turn on the wireless router.
6. Turn on the modem.
7. Turn on your computer.

## Flea power release

**About this task**

Flea power is the residual static electricity that remains on the computer even after it has been powered off and the battery has been removed. The following procedure provides the instructions on how to conduct flea power release:

**Steps**



1. Turn off your computer.
2. Disconnect the power adapter from your computer.
3. Press and hold the power button for 15 seconds to drain the flea power.
4. Connect the power adapter to your computer.
5. Turn on your computer.

# Getting help and contacting Dell

## Self-help resources

You can get information and help on Dell products and services using these self-help resources:

**Table 9. Self-help resources**

Self-help resources	Resource location
Information about Dell products and services	<a href="http://www.dell.com">www.dell.com</a>
My Dell	
Tips	
Contact Support	In Windows search, type <code>Contact Support</code> , and press Enter.
Online help for operating system	<a href="http://www.dell.com/support/windows">www.dell.com/support/windows</a> <a href="http://www.dell.com/support/linux">www.dell.com/support/linux</a>
Access top solutions, diagnostics, drivers and downloads, and learn more about your computer through videos, manuals and documents.	Your Dell computer is uniquely identified by a Service Tag or Express Service Code. To view relevant support resources for your Dell computer, enter the Service Tag or Express Service Code at <a href="http://www.dell.com/support">www.dell.com/support</a> .  For more information on how to find the Service Tag for your computer, see <a href="#">Locate the Service Tag on your computer</a> .
Dell knowledge base articles for a variety of computer concerns	<ol style="list-style-type: none"> <li>1. Go to <a href="http://www.dell.com/support">www.dell.com/support</a>.</li> <li>2. On the menu bar at the top of the Support page, select <b>Support &gt; Knowledge Base</b>.</li> <li>3. In the Search field on the Knowledge Base page, type the keyword, topic, or model number, and then click or tap the search icon to view the related articles.</li> </ol>

## Contacting Dell

To contact Dell for sales, technical support, or customer service issues, see [www.dell.com/contactdell](http://www.dell.com/contactdell).

 **NOTE:** Availability varies by country/region and product, and some services may not be available in your country/region.

 **NOTE:** If you do not have an active Internet connection, you can find contact information about your purchase invoice, packing slip, bill, or Dell product catalog.

### Topics:

- [Contacting Dell](#)

# Contacting Dell

## Prerequisites

 **NOTE:** If you do not have an active Internet connection, you can find contact information on your purchase invoice, packing slip, bill, or Dell product catalog.

## About this task

Dell provides several online and telephone-based support and service options. Availability varies by country and product, and some services may not be available in your area. To contact Dell for sales, technical support, or customer service issues:

## Steps

1. Go to **Dell.com/support**.
2. Select your support category.
3. Verify your country or region in the **Choose a Country/Region** drop-down list at the bottom of the page.
4. Select the appropriate service or support link based on your need.