



# **PowerLite 700U User's Guide**



---

# Contents

<b>PowerLite 700U User's Guide</b> .....	<b>11</b>
<b>Introduction to Your Projector</b> .....	<b>12</b>
Projector Features .....	12
Product Box Contents .....	13
Additional Components .....	14
Optional Equipment and Replacement Parts .....	15
Warranty and Registration Information .....	16
Notations Used in the Documentation .....	16
Where to Go for Additional Information .....	16
Additional Projector Software and Manuals .....	17
Projector Part Locations .....	18
Projector Parts - Front/Side .....	19
Projector Parts - Top/Side .....	20
Projector Parts - Back Panel .....	22
Projector Parts - Base .....	24
Projector Parts - Control Panel .....	25
Projector Parts - Remote Control .....	26
<b>Setting Up the Projector</b> .....	<b>29</b>
Projector Placement .....	29
Projector Setup and Installation Options .....	29
Projection Distance .....	31
Removing and Attaching the Cable Cover .....	34
Projector Connections .....	35
Connecting to Computer Sources .....	36
Connecting to a Computer for USB Video and Audio .....	36
Connecting to a Computer for VGA Video and Audio .....	37
Connecting to a Computer for HDMI Video and Audio .....	38
Connecting to a Computer for Sound .....	39
Connecting to Video Sources .....	40
Connecting to an HDMI Video Source .....	40

Connecting to an MHL-Compatible Device .....	41
Connecting to a Component Video Source .....	42
Connecting to a Composite Video Source .....	43
Connecting to a Video Source for Sound .....	44
Connecting External Output Devices .....	45
Connecting to an External Computer Monitor .....	45
Connecting to External Speakers.....	46
Connecting to External USB Devices .....	47
USB Device Projection.....	47
Connecting a USB Device or Camera to the Projector .....	48
Selecting the Connected USB Source .....	49
Disconnecting a USB Device or Camera From the Projector .....	50
Connecting to a Document Camera .....	50
Installing Batteries in the Remote Control .....	51
<b>Using the Projector on a Network .....</b>	<b>53</b>
Wired Network Projection.....	53
Connecting to a Wired Network .....	53
Selecting Wired Network Settings .....	54
Wireless Network Projection .....	57
Installing the Wireless LAN Module .....	58
Connecting Directly to a Smartphone or Tablet .....	60
Using Quick Wireless Connection (Windows).....	63
Selecting Wireless Network Settings Manually.....	64
Wireless LAN Menu Settings .....	68
Selecting Wireless Network Settings in Windows .....	70
Selecting Wireless Network Settings on Mac .....	70
Setting Up Wireless Network Security .....	71
Setting Up Projector Network E-Mail Alerts .....	72
Network Projector E-mail Alert Messages .....	73
Setting Up Monitoring Using SNMP .....	74
Controlling a Networked Projector Using a Web Browser .....	76
Crestron RoomView Support.....	79
Setting Up Crestron RoomView Support .....	80

Controlling a Networked Projector Using Crestron RoomView .....	81
Registering a Digital Certificate on the Projector .....	82
Importing a Web Server Certificate Using the Projector Menus .....	82
Registering Digital Certificates from a Web Browser .....	84
Digital Certificate Types .....	85
<b>Using Basic Projector Features .....</b>	<b>87</b>
Turning On the Projector .....	87
Using the Home Screen .....	89
Turning Off the Projector .....	91
Selecting the Language for the Projector Menus .....	92
Setting the Date and Time .....	93
Image Shape .....	94
Correcting Image Shape with the Keystone Buttons .....	94
Correcting Image Shape with Quick Corner .....	97
Correcting Image Shape with Arc Correction .....	99
Adjusting the Image Height .....	100
Resizing the Image with the Wide and Tele Buttons .....	102
Adjusting the Image Position .....	103
Focusing the Image .....	104
Remote Control Operation .....	105
Using the Remote Control as a Wireless Mouse .....	107
Using the Remote Control as a Pointer .....	108
Selecting an Image Source .....	109
Projection Modes .....	110
Changing the Projection Mode Using the Remote Control .....	111
Changing the Projection Mode Using the Menus .....	111
Image Aspect Ratio .....	112
Changing the Image Aspect Ratio .....	112
Available Image Aspect Ratios .....	113
Color Mode .....	114
Changing the Color Mode .....	114
Available Color Modes .....	115
Turning On Automatic Luminance Adjustment .....	116

Controlling the Volume with the Volume Buttons.....	116
Projecting a PC Free Presentation .....	117
Supported PC Free File Types .....	117
Starting a PC Free Slide Show .....	118
Starting a PC Free Movie Presentation .....	120
PC Free Display Options .....	122
<b>Adjusting Projector Features .....</b>	<b>124</b>
Projecting Two Images Simultaneously.....	125
Input Sources for Split Screen Projection .....	127
Using Multiple Projectors .....	127
Projector Identification System for Multiple Projector Control .....	128
Setting the Projector ID .....	128
Setting the Remote Control ID .....	129
Adjusting Color Uniformity .....	130
Adjusting the Projector's Brightness Level.....	132
Matching the Image Colors .....	134
Adjusting RGBCMY .....	136
Shutting Off the Picture and Sound Temporarily .....	139
Stopping Video Action Temporarily .....	139
Zooming Into and Out of Images .....	140
Scheduling Projector Events .....	141
Saving a Scheduled Event.....	141
Viewing Scheduled Events .....	142
Editing a Scheduled Event.....	143
Projector Security Features.....	144
Password Security Types .....	145
Setting a Password .....	145
Selecting Password Security Types.....	147
Entering a Password to Use the Projector.....	148
Saving a User's Logo Image to Display.....	149
Locking the Projector's Buttons .....	151
Unlocking the Projector's Buttons .....	153
Installing a Security Cable .....	153

Creating a User Pattern to Display .....	154
Copying Menu Settings Between Projectors .....	155
Saving Settings to a USB Flash Drive.....	156
Transferring Settings from a USB Flash Drive .....	157
Saving Settings to a Computer .....	158
Transferring Settings from a Computer .....	159
<b>Adjusting the Menu Settings .....</b>	<b>162</b>
Using the Projector's Menus.....	162
Image Quality Settings - Image Menu .....	164
Input Signal Settings - Signal Menu.....	167
Projector Feature Settings - Settings Menu.....	169
Projector Setup Settings - Extended Menu.....	173
Projector Network Settings - Network Menu.....	178
Projector Setup Settings - ECO Menu .....	180
Projector Information Display - Info Menu .....	183
Event ID Code List.....	184
Projector Reset Options - Reset Menu .....	186
<b>Maintaining and Transporting the Projector .....</b>	<b>187</b>
Projector Maintenance .....	187
Cleaning the Projection Window.....	187
Cleaning the Obstacle Sensor .....	188
Cleaning the Projector Case.....	189
Air Filter and Vent Maintenance .....	189
Cleaning the Air Filter and Vents .....	190
Replacing the Air Filter .....	193
Replacing the Remote Control Batteries .....	196
Transporting the Projector .....	198
<b>Solving Problems .....</b>	<b>199</b>
Projection Problem Tips .....	199
Projector Light Status .....	200
Using the Projector Help Displays .....	203
Solving Image or Sound Problems .....	203
Solutions When No Image Appears.....	204

Solutions When Image is Incorrect Using the USB Display Function .....	205
Solutions When "No Signal" Message Appears.....	205
Displaying From a PC Laptop .....	206
Displaying From a Mac Laptop .....	207
Solutions When "Not Supported" Message Appears .....	207
Solutions When Only a Partial Image Appears .....	207
Solutions When the Image is Not Rectangular .....	208
Solutions When the Image Contains Noise or Static .....	209
Solutions When the Image is Fuzzy or Blurry .....	209
Solutions When the Image Brightness or Colors are Incorrect .....	210
Solutions to Sound Problems .....	211
Solving Projector or Remote Control Operation Problems .....	212
Solutions to Projector Power or Shut-Off Problems .....	212
Solutions to Problems with the Remote Control.....	213
Solutions to Password Problems .....	214
Solving Network Problems .....	215
Solutions When Wireless Authentication Fails .....	215
Solutions When You Cannot Access the Projector Through the Web .....	215
Solutions When Network Alert E-Mails are Not Received.....	216
Solutions When the Image Contains Static During Network Projection .....	216
Where to Get Help.....	217
<b>Technical Specifications .....</b>	<b>218</b>
General Projector Specifications .....	218
Projector Light Source Specifications.....	220
Remote Control Specifications .....	220
Projector Dimension Specifications.....	221
Projector Electrical Specifications .....	221
Projector Environmental Specifications.....	222
Projector Safety and Approvals Specifications.....	222
Supported Video Display Formats.....	222
USB Display System Requirements.....	225
<b>Notices .....</b>	<b>226</b>
Recycling.....	226



Important Safety Information .....	226
Laser Safety Information .....	227
Important Safety Instructions.....	229
Restriction of Use .....	231
List of Safety Symbols (corresponding to IEC60950-1 A2).....	232
FCC Compliance Statement.....	235
Binding Arbitration and Class Waiver .....	236
Trademarks .....	239
Copyright Notice.....	240
A Note Concerning Responsible Use of Copyrighted Materials.....	240
Copyright Attribution .....	240



---

# PowerLite 700U User's Guide

Welcome to the PowerLite 700U *User's Guide*.

For a printable PDF copy of this guide, [click here](#).

---

# Introduction to Your Projector

Refer to these sections to learn more about your projector and this manual.

[Projector Features](#)

[Notations Used in the Documentation](#)

[Where to Go for Additional Information](#)

[Additional Projector Software and Manuals](#)

[Projector Part Locations](#)

## Projector Features

The PowerLite 700U projector includes these special features:

### **Bright, high-resolution projection system**

- Up to 4000 lumens of color brightness (color light output) and white brightness (white light output)

**Note:** Color brightness (color light output) and white brightness (white light output) will vary depending on usage conditions. Color light output measured in accordance with IDMS 15.4; white light output measured in accordance with ISO 21118.

- Native resolution of 1920 × 1200 pixels (WUXGA)

### **Flexible connectivity**

- Three HDMI ports (including one MHL-compatible port) for computer or video device connection
- Plug-and-play 3-in-1 USB projection, audio, and mouse control for instant setup
- Wired and wireless network support for projection
- Projector monitoring and control via remote network computer
- PC Free photo slide shows via connected USB memory devices or Epson document camera
- Use Epson iProjection (Windows/Mac) to simultaneously project up to four images from network computers or mobile devices using the Epson iProjection app
- Projection from iOS or Android devices with the optional wireless LAN module and free Epson iProjection app; visit [epson.com/iprojection](http://epson.com/iprojection) (U.S.) or [epson.ca/iprojection](http://epson.ca/iprojection) (Canada) for more information

### **Innovative display and operation features**

- Long-life laser light source

- Support for side-by-side projector mounting
- High digital zoom ratio for larger images in shorter projection distances
- 2500000:1 contrast ratio and Dynamic Contrast control for sharp, detailed images
- Built-in closed captioning decoder
- Powerful 16 W speaker system with audio out port for connecting external speakers
- Epson's Direct Power On and Auto Power On features for quick and easy setup
- Support for Crestron RoomView network monitoring systems
- Network message broadcast system to project timely messages to all networked projectors

[Product Box Contents](#)

[Additional Components](#)

[Optional Equipment and Replacement Parts](#)

[Warranty and Registration Information](#)

**Parent topic:** [Introduction to Your Projector](#)

## Product Box Contents

Save all the packaging in case you need to ship the projector. Always use the original packaging (or equivalent) when shipping.

Make sure your projector box included all of these parts:

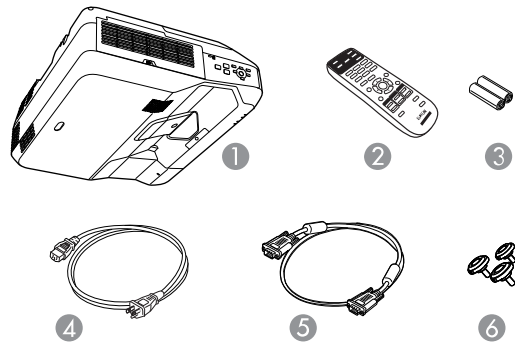

- 1 Projector
- 2 Remote control

- 3 Remote control batteries (2 AA alkaline)
- 4 Power cord
- 5 VGA computer cable
- 6 Projector feet

Parent topic: [Projector Features](#)

## Additional Components

Depending on how you plan to use the projector, you may need to obtain additional components.

**Note:** To connect a Mac that does not include a compatible video output port, you need to obtain an adapter that allows you to connect to an input port on the projector. Contact Apple for compatible adapter options. To connect a smartphone or tablet, you may need to obtain an adapter that allows you to connect to the projector. This allows you to mirror your smartphone or tablet screens, watch movies, and more. Contact your device manufacturer for compatible adapter options.

Unless listed as available from Epson in this table, see your local computer or electronics dealer for purchase information.

Signal or connection type	Additional component necessary
Composite video	RCA-style video or A/V cable
Component video	D-sub, 15-pin, component-to-VGA video cable or adapter Available for purchase from Epson or an authorized Epson reseller.
HDMI	Compatible HDMI cable Available for purchase from Epson or an authorized Epson reseller. <b>Note:</b> Older Mac computers (2009 and earlier) may not support HDMI audio.
MHL	MHL-compatible device or device with an integrated MHL connector or HDMI cable and MHL adapter compatible with your device Available for purchase from Epson or an authorized Epson reseller.
Audio from certain ports	Commercially available audio cable compatible with your device

Signal or connection type	Additional component necessary
USB	Compatible USB cable

Parent topic: [Projector Features](#)

## Optional Equipment and Replacement Parts

You can purchase screens, other optional accessories, and replacement parts from an Epson authorized reseller. To find the nearest reseller, call 800-GO-EPSON (800-463-7766) in the U.S. or 800-807-7766 in Canada. Or you can purchase online at [epsonstore.com](http://epsonstore.com) (U.S. sales) or [epsonstore.ca](http://epsonstore.ca) (Canadian sales).

Epson offers the following optional accessories and replacement parts for your projector:

Option or part	Part number
Replacement air filter (ELPAF43)	V13H134A43
Ultra-short throw wall mount (ELPMB53)	V12H902020
Wireless LAN module (ELPAP10)	V12H731P02
Epson DC-06 document camera (ELPDC06)	V12H321005
Epson DC-07 document camera (ELPDC07)	V12H759020
Epson DC-11 document camera (ELPDC11)	V12H377020
Epson DC-12 document camera (ELPDC12)	V12H594020
Epson DC-13 document camera (ELPDC13)	V12H757020
Epson DC-20 document camera (ELPDC20)	V12H500020
Epson DC-21 document camera (ELPDC21)	V12H758020
Active speakers (ELPSP02)	V12H467020
10 ft. (3.0 m) Component-to-VGA video cable	ELPKC19
10 ft. (3.0 m) HD-TV cable	ELPKC22

In addition to the accessories listed above, 1-year and 2-year extended service plans are available.

Parent topic: [Projector Features](#)

## Warranty and Registration Information

Your projector comes with a basic warranty that lets you project with confidence. For details, see the warranty that came with your projector.

In addition, Epson offers free Extra Care Road Service. In the unlikely event of an equipment failure, you won't have to wait for your unit to be repaired. Instead, Epson will ship you a replacement unit anywhere in the United States, Canada, or Puerto Rico. See the Extra Care Road Service brochure for details.

Register your product online at this site: [epson.com/webreg](http://epson.com/webreg).

Registering also lets you receive special updates on new accessories, products, and services.

**Parent topic:** [Projector Features](#)

## Notations Used in the Documentation

Follow the guidelines in these notations as you read your documentation:

- **Warnings** must be followed carefully to avoid bodily injury.
- **Cautions** must be observed to avoid damage to your equipment.
- **Notes** contain important information about your projector.
- **Tips** contain additional projection information.

**Parent topic:** [Introduction to Your Projector](#)

## Where to Go for Additional Information

Need quick help on using your projector? Here's where to look for help:

- Built-in help system

Press the **Home** button on the remote control or projector, press the arrow buttons to select the help icon, and press **Enter** to get quick solutions to common problems. 

- [epson.com/support](http://epson.com/support) (U.S.) or [epson.ca/support](http://epson.ca/support) (Canada)

View FAQs (frequently asked questions) and e-mail your questions to Epson technical support 24 hours a day.

- If you still need help after checking this manual and any other sources listed here, you can use the Epson PrivateLine Support service to get help fast. For details, see "Where to Get Help".

**Parent topic:** [Introduction to Your Projector](#)



## Related references

[Where to Get Help](#)

## Additional Projector Software and Manuals

After connecting and setting up the projector, download the projector software and manuals as necessary.

You can install the projector software programs listed here and view their manuals for instructions on using them.

**Note:** If you still need help after checking this manual and the sources listed here, you can use the Epson PrivateLine Support service to get help fast. For details, see "Where to Get Help".

Projector software	Manual	Description
Epson Projector Management (Windows only)	<i>Epson Projector Management Guide</i>	Lets you monitor and control your projector through the network.  You can download the latest software and documentation from the Epson web site. Go to <a href="http://epson.com/support">epson.com/support</a> (U.S.) or <a href="http://epson.ca/support">epson.ca/support</a> (Canada) and select your projector.
Epson iProjection (Windows/Mac)	<i>Epson iProjection Operation Guide</i>	Lets you project the computer screens of users over a network.  You can download the latest software and documentation from the Epson web site. Go to <a href="http://epson.com/support">epson.com/support</a> (U.S.) or <a href="http://epson.ca/support">epson.ca/support</a> (Canada) and select your projector.
EasyMP Network Updater (Windows only)	<i>EasyMP Network Updater Operation Guide</i>	Lets you update firmware for a projector over a wired LAN.  You can download the latest software and documentation from the Epson web site. Go to <a href="http://epson.com/support">epson.com/support</a> (U.S.) or <a href="http://epson.ca/support">epson.ca/support</a> (Canada) and select your projector.

Projector software	Manual	Description
Epson iProjection app	Instructions are included with the app	Lets you project from an iOS device, Android device, or Chromebook if your projector is connected to a network that includes a wireless access point.  Visit <a href="http://epson.com/iprojection">epson.com/iprojection</a> (U.S.) or <a href="http://epson.ca/iprojection">epson.ca/iprojection</a> (Canada) for more information.
—	<i>Open Source Software License</i>	You can download this document from the Epson web site. Go to <a href="http://epson.com/support">epson.com/support</a> (U.S.) or <a href="http://epson.ca/support">epson.ca/support</a> (Canada) and select your projector. (Document available only in English.)

**Parent topic:** [Introduction to Your Projector](#)

## Projector Part Locations

Check the projector part illustrations to learn about the parts on your projector.

[Projector Parts - Front/Side](#)

[Projector Parts - Top/Side](#)

[Projector Parts - Back Panel](#)

[Projector Parts - Base](#)

[Projector Parts - Control Panel](#)

[Projector Parts - Remote Control](#)

**Parent topic:** [Introduction to Your Projector](#)

## Projector Parts - Front/Side

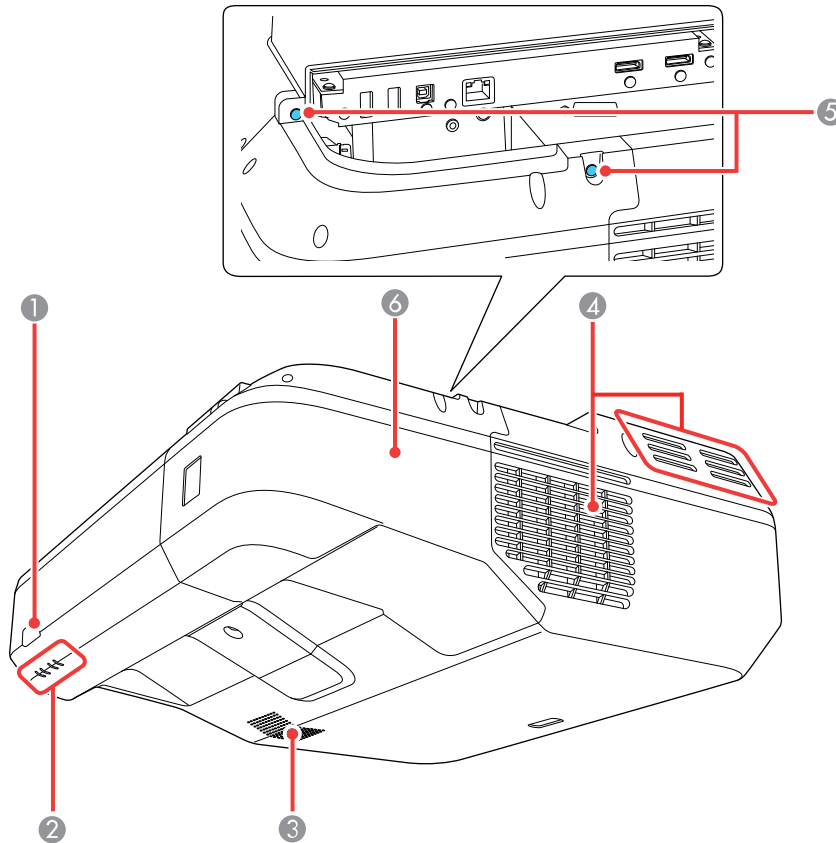

- 1 Remote control receiver
- 2 Status lights
- 3 Speaker
- 4 Exhaust vent
- 5 Cable cover screws
- 6 Cable cover

Parent topic: [Projector Part Locations](#)

## Projector Parts - Top/Side

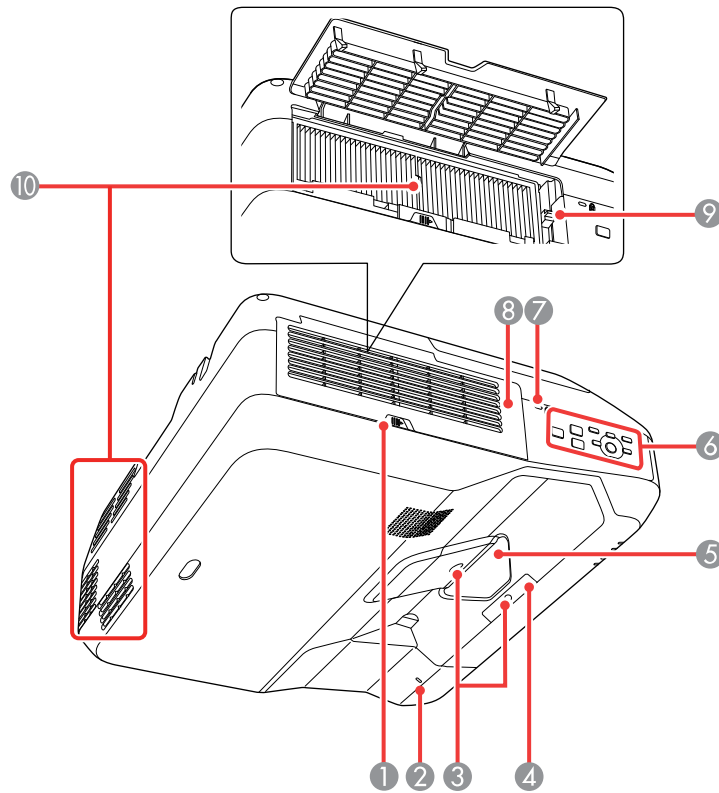

- 1 Air filter cover latch
- 2 Wireless LAN light
- 3 Obstacle sensors
- 4 Remote receiver
- 5 Projection window
- 6 Control panel

- 7 Security cable installation slot
- 8 Air filter cover
- 9 Focus lever
- 10 Air intake vent (air filter)

**Parent topic:** [Projector Part Locations](#)

**Related references**

[Projector Light Status](#)

## Projector Parts - Back Panel

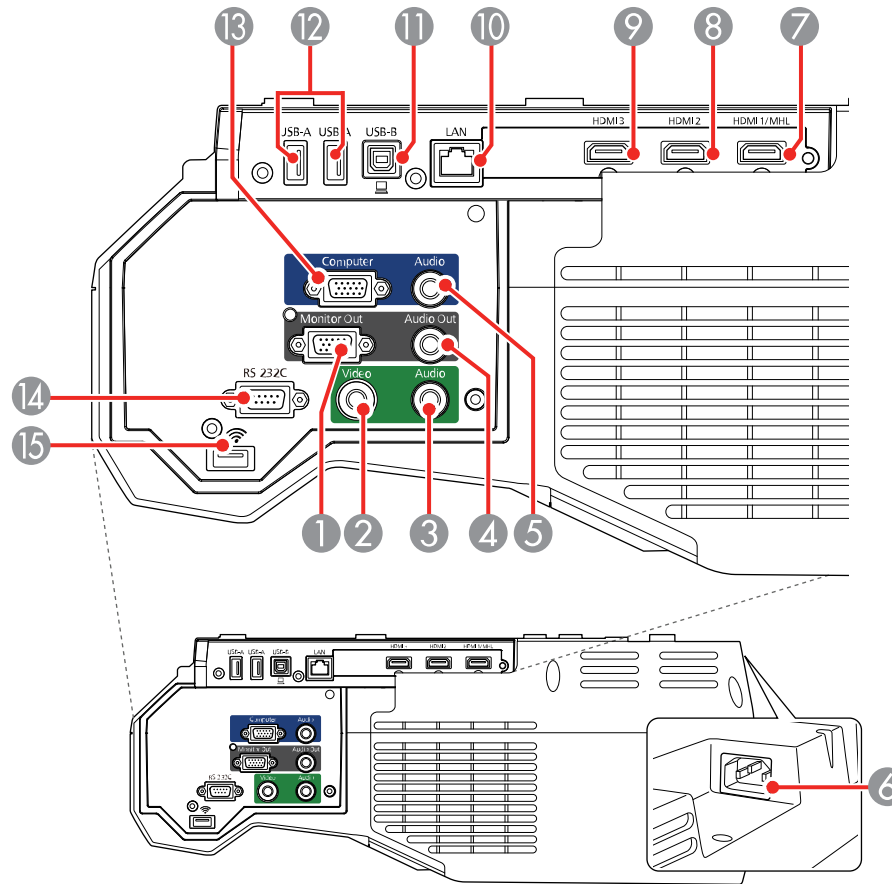

- 1 **Monitor Out** port
- 2 **Video** port
- 3 **Audio** port for use with the **Video** port
- 4 **Audio Out** port
- 5 **Audio** port for use with the **Computer** port

- 6 Power inlet
- 7 **HDMI 1/MHL** port
- 8 **HDMI 2** port
- 9 **HDMI 3** port
- 10 Network (**LAN**) port
- 11 **USB-B** port for computer connection
- 12 **USB-A** ports for USB memory device or document camera
- 13 **Computer** port
- 14 **RS-232C** port
- 15 Wireless LAN module port

**Parent topic:** [Projector Part Locations](#)

**Related concepts**

[Projector Connections](#)

## Projector Parts - Base

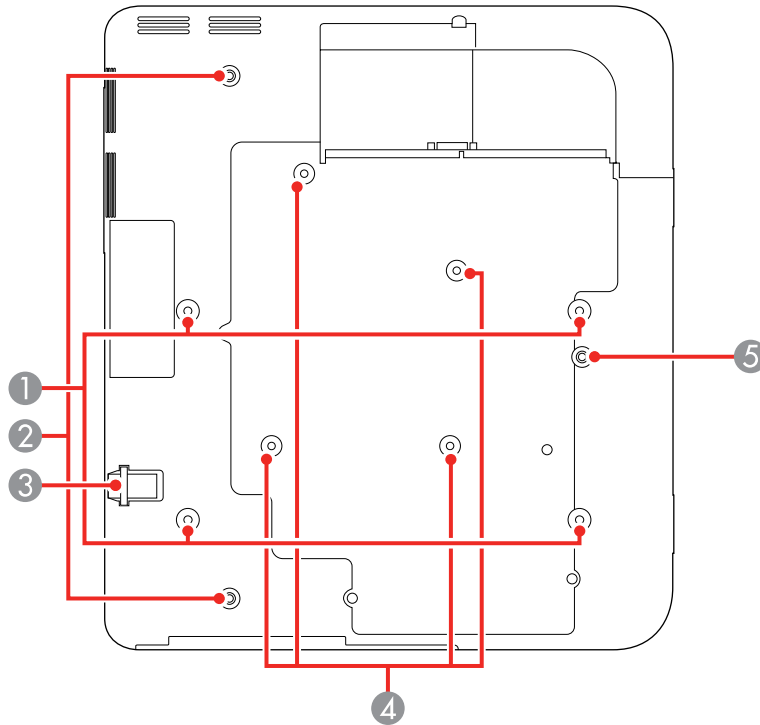

- 1 Ceiling mount holes (4)
- 2 Rear foot holes (2)
- 3 Security cable attachment point
- 4 Wall mounting plate holes (4)
- 5 Front foot hole

Parent topic: [Projector Part Locations](#)



## Projector Parts - Control Panel

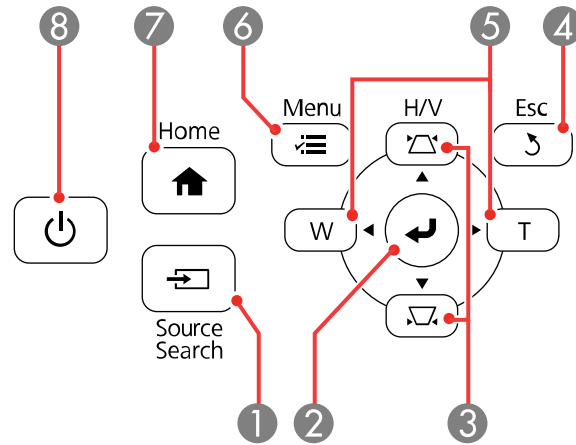

- 1 **Source Search** button (searches for connected video sources)
- 2 **↩** (Enter) button (selects options)
- 3 Vertical keystone adjustment buttons (display the adjustment screen and adjust screen shape) and arrow buttons
- 4 **Esc** button (cancels/exits functions)
- 5 **W/T** (Wide/Tele) buttons (adjust projected image size) and arrow buttons
- 6 **Menu** button (accesses projector menu system)
- 7 **Home** button (accesses projector Home screen)
- 8 Power button

Parent topic: [Projector Part Locations](#)

# Projector Parts - Remote Control

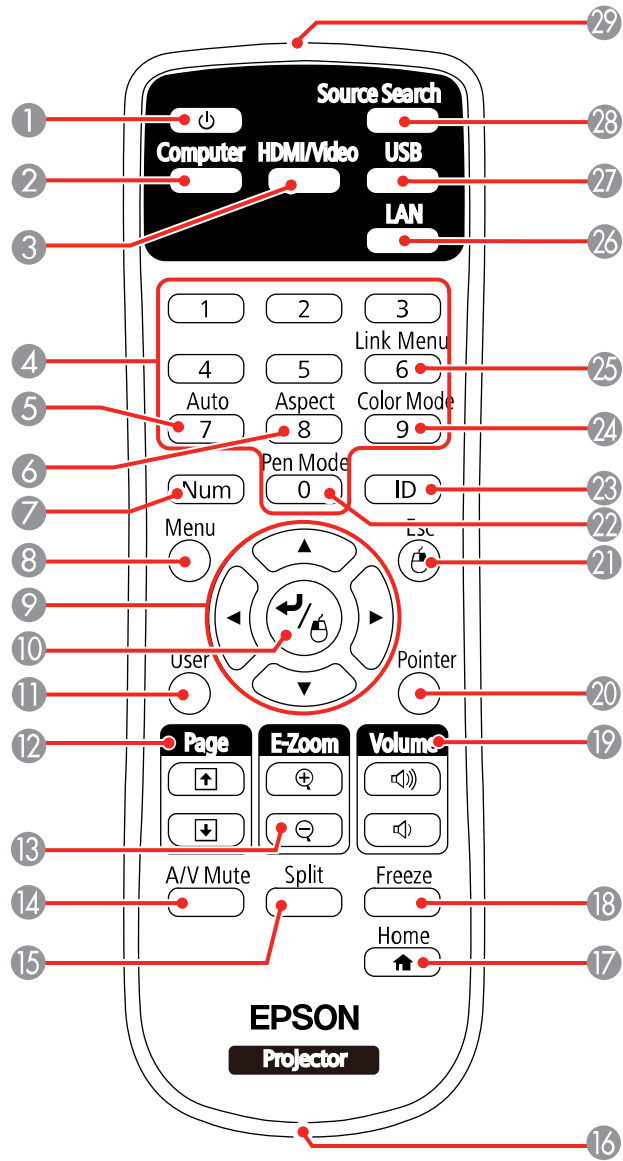

- 1 Power button
- 2 **Computer** button
- 3 **HDMI/Video** button (cycles through connected HDMI and video sources)
- 4 Numeric buttons
- 5 **Auto** button (automatically adjusts position, tracking, and sync settings)
- 6 **Aspect** button (selects the image aspect ratio)
- 7 **Num** button (when held down, switches numeric buttons to number function)
- 8 **Menu** button (accesses projector menu system)
- 9 Arrow buttons (move through on-screen options and control wireless mouse functions)
- 10  Enter button (selects options and controls wireless mouse functions)
- 11 **User** button (customizable for different functions)
- 12 **Page** up/down buttons (control presentation slides)
- 13 **E-Zoom +/-** buttons (zoom into and out of the image)
- 14 **A/V Mute** button (turns off picture and sound)
- 15 **Split** button (splits the screen between two image sources)
- 16 Strap attachment point
- 17 **Home** button (accesses projector Home screen)
- 18 **Freeze** button (stops video action)
- 19 **Volume** up/down buttons (adjust speaker volume)
- 20 **Pointer** button (activates on-screen pointer)
- 21 **Esc** button (cancels/exits functions and controls wireless mouse functions)
- 22 **Pen Mode** button (not supported on this model)
- 23 **ID** button (selects a projector to use with the remote control)
- 24 **Color Mode** button (selects display modes)
- 25 **Link Menu** button (displays settings or performs functions for the device connected to the HDMI port)
- 26 **LAN** button (connects to a network source)
- 27 **USB** button (cycles between USB Display and USB-A ports)

28 **Source Search** button (searches for connected sources)

29 Remote control emitter

**Parent topic:** [Projector Part Locations](#)

---

# Setting Up the Projector

Follow the instructions in these sections to set up your projector for use.

[Projector Placement](#)

[Removing and Attaching the Cable Cover](#)

[Projector Connections](#)

[Installing Batteries in the Remote Control](#)

## Projector Placement

Your ultra-short throw projector is designed to be installed on a wall (with a wall mount).

You can also place the projector on a flat surface such as a desk or table to project in a portable setup.

Keep these considerations in mind as you select a projector location:

- Follow the instructions in the *Installation Guide* provided with your mounting hardware to install the projector using the included mounting equipment.
- Leave plenty of space around and under the projector for ventilation, and do not place it on top of or next to anything that could block the vents.
- Position the projector within reach of a grounded electrical outlet or extension cord.
- If installing on a wall, the wall mount (V12H902020) is required.
- If the projector is not mounted, place it on a sturdy, level surface.

[Projector Setup and Installation Options](#)

[Projection Distance](#)

**Parent topic:** [Setting Up the Projector](#)

## Projector Setup and Installation Options

You can set up or install your projector in the following ways:

Mounted on the wall or ceiling

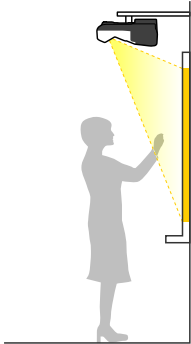

Mounted on the wall or ceiling and projecting from behind a translucent screen

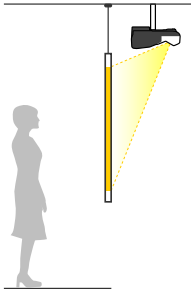

Front projection from a table or portable cart

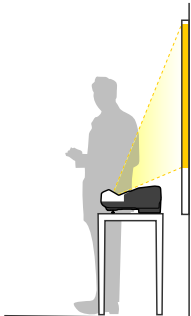

Rear projection from a table or portable cart behind a translucent screen

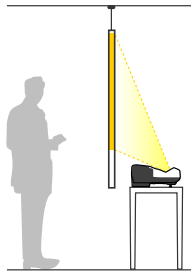

Wherever you set up the projector, make sure to position it squarely in front of the screen, not at an angle.

If you project from a table or portable cart, or from the rear, be sure to select the correct **Projection** option in the projector's menu system.

**Parent topic:** [Projector Placement](#)

## Projection Distance

The distance at which you place the projector from the screen determines the approximate size of the image. The image size increases the farther the projector is from the screen, but can vary depending on the zoom factor, aspect ratio, and other settings.

Use the tables here to determine approximately how far to place the projector from the screen based on the size of the projected image. (Conversion figures may have been rounded up or down.)

You can also use the Projection Distance Calculator [here](#) (U.S.), [here](#) (Canada), or [here](#) (Caribbean) .

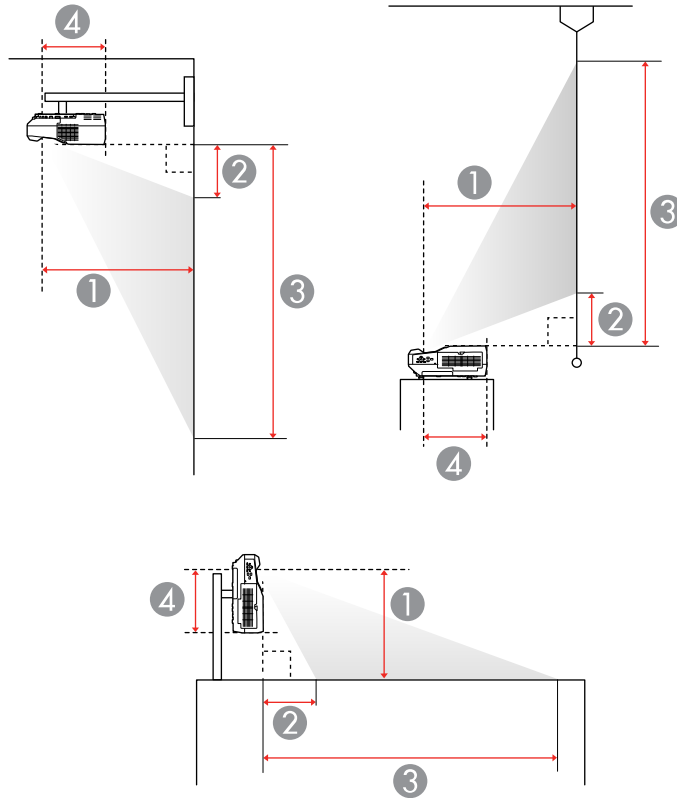

- 1 Projection distance
- 2 Distance from the top of the projector to the top of the image (when projecting from a wall or table mount) or base of the image (when projecting from a flat surface)
- 3 Distance from the top of the projector to the base of the image (when projecting from a wall or table mount) or top of the image (when projecting from a flat surface)
- 4 Distance from the center of the lens to the rear of the projector: 13.7 inches (34.9 cm)



<b>16:10 Aspect Ratio Image or Screen</b>			
<b>Screen or image size</b>	<b>Projection distance (1) Wide to Tele</b>	<b>Offset from lens center (2)</b>	<b>Offset from lens center (3)</b>
70 inches (177.8 cm)	15.9 to 22 inches (40.5 to 55.8 cm)	5.1 inches (12.9 cm)	42.2 inches (107.2 cm)
75 inches (190.5 cm)	17.1 to 23.6 inches (43.6 to 60.1 cm)	5.6 inches (14.3 cm)	45.4 inches (115.3 cm)
80 inches (203.2 cm)	18.4 to 25.3 inches (46.7 to 64.3 cm)	6.2 inches (15.7 cm)	48.6 inches (123.4 cm)
90 inches (228.6 cm)	20.8 to 28.6 inches (53.0 to 72.8 cm)	7.3 inches (18.6 cm)	55 inches (139.7 cm)
100 inches (254 cm)	23.3 inches (59.3 cm)*	8.4 inches (21.4 cm)	61.4 inches (156.0 cm)
110 inches (279.4 cm)	25.8 inches (65.6 cm)*	9.5 inches (24.2 cm)	67.8 inches (172.2 cm)
120 inches (304.8 cm)	28.3 inches (71.9 cm)*	10.6 inches (27.0 cm)	74.2 inches (188.5 cm)
130 inches (330.2 cm)	30.7 inches (78.1 cm)*	11.7 inches (29.8 cm)	80.6 inches (204.8 cm)

\*Wide resolution only

<b>4:3 Aspect Ratio Image or Screen</b>			
<b>Screen or image size</b>	<b>Projection distance (1) Wide to Tele</b>	<b>Offset from lens center (2)</b>	<b>Offset from lens center (3)</b>
70 inches (177.8 cm)	18.2 to 25 inches (46.3 to 63.7 cm)	6.1 inches (15.5 cm)	48.1 inches (122.2 cm)
80 inches (203.2 cm)	21 to 28.8 inches (53.4 to 73.3 cm)	7.3 inches (18.7 cm)	55.3 inches (140.6 cm)
90 inches (228.6 cm)	23.8 inches (60.5 cm)*	8.6 inches (21.9 cm)	62.6 inches (159.0 cm)
100 inches (254 cm)	26.6 inches (67.6 cm)*	9.8 inches (25.1 cm)	69.8 inches (177.5 cm)
110 inches (279.4 cm)	29.4 inches (74.7 cm)*	11.1 inches (28.2 cm)	77.1 inches (195.9 cm)

\*Wide resolution only

<b>16:9 Aspect Ratio Image or Screen</b>			
<b>Screen or image size</b>	<b>Projection distance (1) Wide to Tele</b>	<b>Offset from lens center (2)</b>	<b>Offset from lens center (3)</b>
70 inches (177.8 cm)	16.4 to 22.6 inches (41.7 to 57.5 cm)	7.2 inches (18.3 cm)	41.5 inches (105.5 cm)
80 inches (203.2 cm)	18.9 to 26 inches (48.1 to 66.2 cm)	8.6 inches (21.9 cm)	47.8 inches (121.5 cm)
90 inches (228.6 cm)	21.5 to 29.5 inches (54.6 to 74.9 cm)	10 inches (25.5 cm)	54.1 inches (137.6 cm)
100 inches (254 cm)	24 inches (61.0 cm)*	11.4 inches (29.1 cm)	60.4 inches (153.6 cm)
110 inches (279.4 cm)	26.5 inches (67.5 cm)*	12.8 inches (32.6 cm)	66.7 inches (169.6 cm)
125 inches (317.5 cm)	30.4 inches (77.2 cm)*	14.9 inches (38 cm)	76.2 inches (193.6 cm)

\*Wide resolution only

Parent topic: [Projector Placement](#)

## Removing and Attaching the Cable Cover

Before you can connect equipment to your projector, you need to remove the cable cover.

1. Use a screwdriver to remove both of the cable cover screws.
2. Slide off the cable cover.

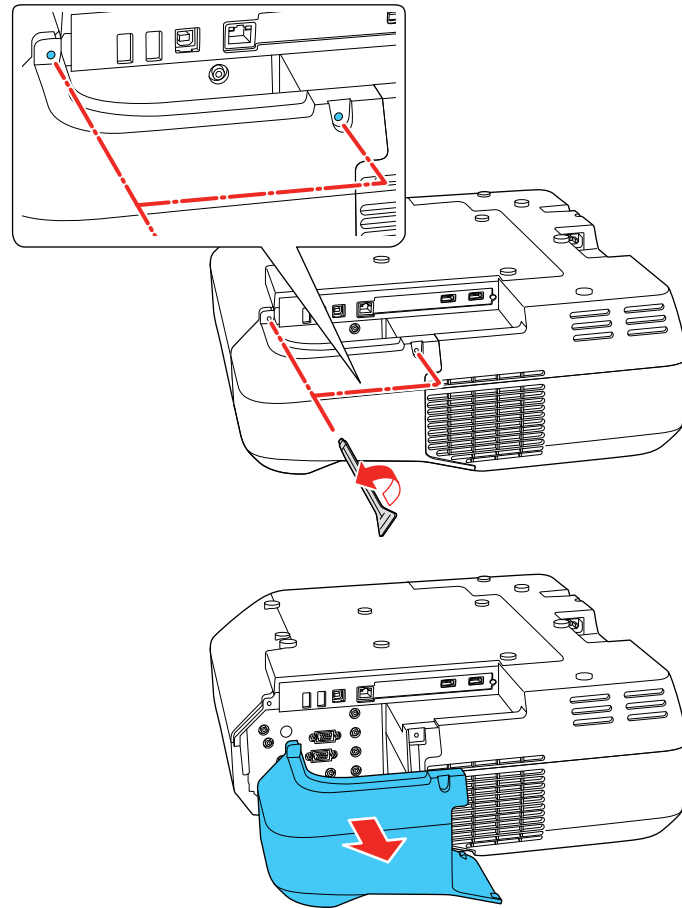

To attach the cable cover, slide it into position and tighten the screws with a screwdriver.

Parent topic: [Setting Up the Projector](#)

## Projector Connections

See these sections to connect the projector to a variety of projection sources.

**Caution:** If you will use the projector at altitudes above 4921 feet (1500 m), turn on **High Altitude Mode** to ensure the projector's internal temperature is regulated properly.

[Connecting to Computer Sources](#)

[Connecting to Video Sources](#)

[Connecting External Output Devices](#)

[Connecting to External USB Devices](#)

[Connecting to a Document Camera](#)

**Parent topic:** [Setting Up the Projector](#)

**Related references**

[Projector Setup Settings - Extended Menu](#)

[Additional Components](#)

## Connecting to Computer Sources

Follow the instructions in these sections to connect a computer to the projector.

[Connecting to a Computer for USB Video and Audio](#)

[Connecting to a Computer for VGA Video and Audio](#)

[Connecting to a Computer for HDMI Video and Audio](#)

[Connecting to a Computer for Sound](#)

**Parent topic:** [Projector Connections](#)

### Connecting to a Computer for USB Video and Audio

If your computer meets the system requirements, you can send video and audio output to the projector through the computer's USB port (preferably USB 2.0). Connect the projector to your computer using a USB cable.

**Note:** A USB connection may cause a delay for content requiring high bandwidth, such as movies. An HDMI connection is recommended for projecting movies, video games, and other home entertainment content.

1. Turn on your computer.

2. Connect the cable to your projector's **USB-B** port.

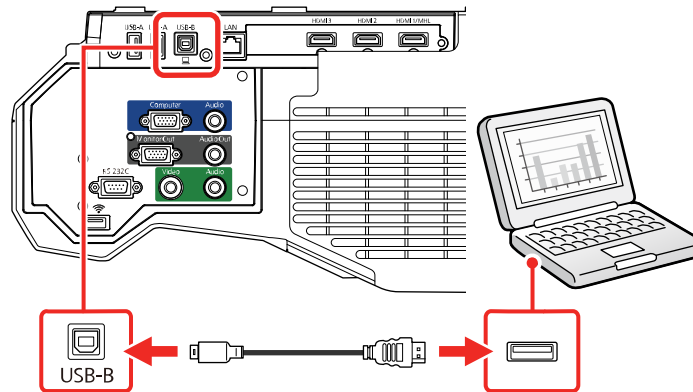

3. Connect the other end to any available USB port on your computer.
4. To use USB Display, do one of the following:
  - **Windows 10/Windows 8.x:** Click **EPSON\_PJ\_UD** in the upper right-corner, then select **Run EMP\_UDSE.exe** in the dialog box that appears to install the Epson USB Display software.
  - **Windows 7/Windows Vista:** Select **Run EMP\_UDSE.exe** in the dialog box that appears to install the Epson USB Display software.
  - **Mac:** The USB Display setup folder appears on your screen. Select **USB Display Installer** and follow the on-screen instructions to install the Epson USB Display software.

Follow any on-screen instructions. You need to install this software only the first time you connect the projector to the computer.

The projector displays the image from your computer's desktop and outputs sound, if your presentation contains audio.

**Parent topic:** [Connecting to Computer Sources](#)

#### **Related references**

[Projector Setup Settings - Extended Menu](#)

### **Connecting to a Computer for VGA Video and Audio**

You can connect the projector to your computer using a VGA computer cable.

**Note:** To connect a Mac that includes only a Mini DisplayPort, Thunderbolt port, or Mini-DVI port for video output, you need to obtain an adapter that allows you to connect to the projector's VGA video port. Contact Apple for compatible adapter options.

1. If necessary, disconnect your computer's monitor cable.
2. Connect the VGA computer cable to your computer's monitor port.
3. Connect the other end to a **Computer** port on the projector.

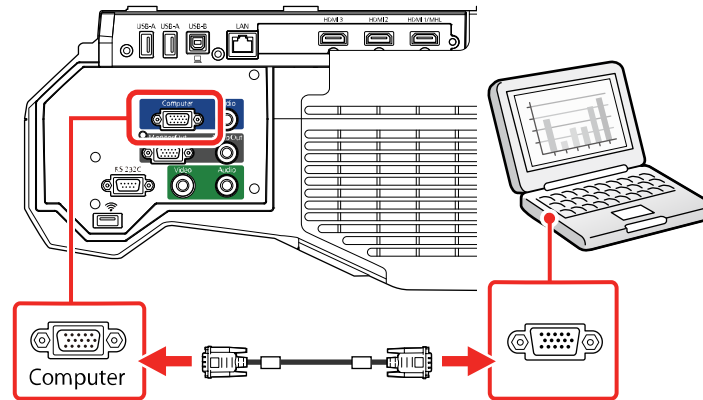

4. Tighten the screws on the VGA connector.

**Parent topic:** [Connecting to Computer Sources](#)

### Connecting to a Computer for HDMI Video and Audio

If your computer has an HDMI port, you can connect it to the projector using an optional HDMI cable.

**Note:** To connect a Mac that includes only a Mini DisplayPort, Thunderbolt port, or Mini-DVI port for video output, you need to obtain an adapter that allows you to connect to the projector's **HDMI** port. Contact Apple for compatible adapter options. Older Mac computers (2009 and earlier) may not support audio through the **HDMI** port.

1. Connect the HDMI cable to your computer's HDMI output port.

2. Connect the other end to one of the projector's HDMI ports.

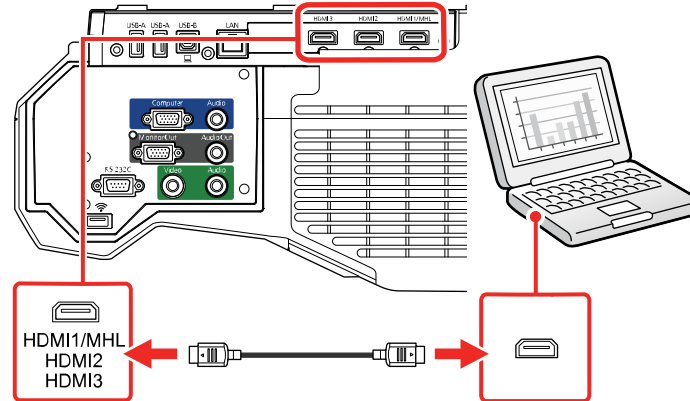

**Note:** The projector converts the digital audio signal sent from your computer into a mono analog signal for the internal speaker or a stereo analog signal if you are connecting to external speakers. (Make sure the HDMI audio playback device on your computer's audio settings is set to **EPSON PJ**.)

**Note:** If you have problems hearing audio through the HDMI connection, you can use one of the projector's audio ports instead to play sound. Connect one end of an optional 3.5 mm stereo mini-jack audio cable to one of the projector's audio ports and the other end to your computer's audio out port. Then select the audio port you connected to as the **HDMI1 Audio Output**, **HDMI2 Audio Output** or **HDMI3 Audio Output** setting in the Extended menu.

**Parent topic:** [Connecting to Computer Sources](#)

### Connecting to a Computer for Sound

If your computer presentation includes sound and you did not connect it to the projector's **USB-B** or an **HDMI** port, you can still play sound through the projector's speaker system. Just connect an optional 3.5 mm stereo mini-jack audio cable as described here.

1. Connect the audio cable to your laptop's headphone or audio-out jack, or your desktop's speaker or audio-out port.

2. Connect the other end to the **Audio** port that corresponds to the **Computer** port you are using.

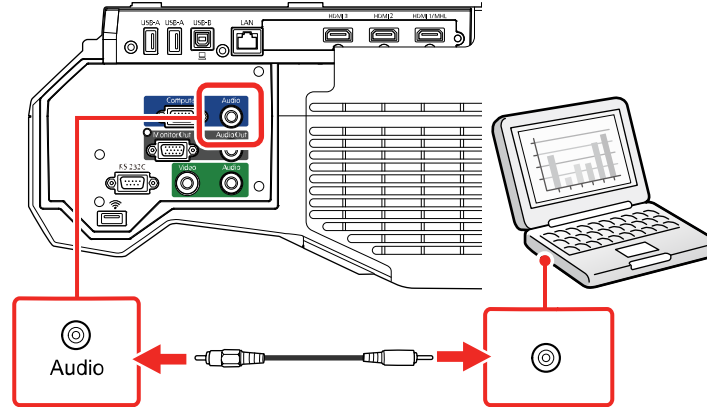

**Parent topic:** [Connecting to Computer Sources](#)

## Connecting to Video Sources

Follow the instructions in these sections to connect video devices to the projector.

[Connecting to an HDMI Video Source](#)

[Connecting to an MHL-Compatible Device](#)

[Connecting to a Component Video Source](#)

[Connecting to a Composite Video Source](#)

[Connecting to a Video Source for Sound](#)

**Parent topic:** [Projector Connections](#)

### Connecting to an HDMI Video Source

If your video source has an HDMI port, you can connect it to the projector using an optional HDMI cable. The HDMI connection provides the best image quality.

1. Connect the HDMI cable to your video source's HDMI output port.



2. Connect the other end to one of the projector's HDMI ports.

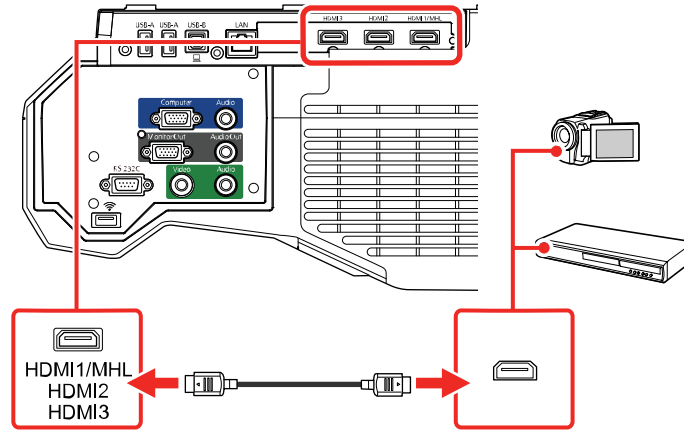

**Note:** The projector converts the digital audio signal sent from your video source into a mono analog signal for the internal speaker or a stereo analog signal if you are connecting to external speakers.

**Note:** If you have problems hearing audio through the HDMI connection, you can use one of the projector's audio ports instead to play sound. Connect one end of an optional 3.5 mm stereo mini-jack audio cable to one of the projector's audio ports and the other end to your video source's audio out port. Then select the audio port you connected to as the **HDMI1 Audio Output**, **HDMI2 Audio Output** or **HDMI3 Audio Output** setting in the Extended menu.

**Parent topic:** [Connecting to Video Sources](#)

#### **Related references**

[Projector Setup Settings - Extended Menu](#)

#### **Connecting to an MHL-Compatible Device**

If you have an MHL-compatible smartphone or tablet, you can connect it to the projector using an HDMI cable with a device-compatible MHL adapter. If you have a device with a built-in MHL connector, plug it directly into the **HDMI 1/MHL** port.

**Note:** Some connected devices may not charge when using an MHL adapter.

1. Connect the MHL cable or adapter to your device's Micro-USB port.

2. If you are using an MHL adapter, connect it to an MHL-compatible HDMI cable.
3. Connect the other end of the cable to the projector's **HDMI 1/MHL** port.

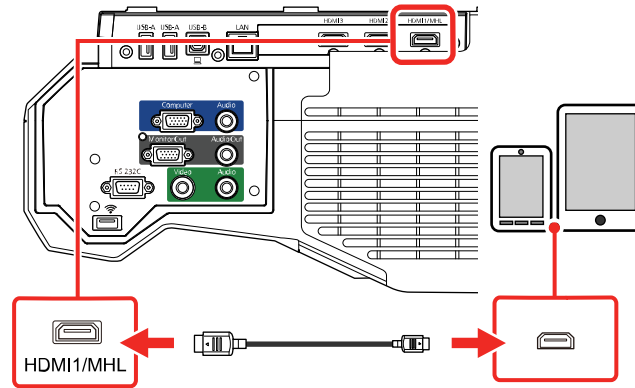

**Note:** The projector converts the digital audio signal sent from your video source into a mono analog signal for the internal speaker or a stereo analog signal if you are connecting to external speakers.

**Parent topic:** [Connecting to Video Sources](#)

### Connecting to a Component Video Source

If your video source has component video ports, you can connect it to the projector using an optional component-to-VGA video cable. Depending on your component ports, you may need to use an adapter cable along with a component video cable.

1. Connect the component connectors to your video source's color-coded component video output ports, usually labeled **Y**, **Pb**, **Pr** or **Y**, **Cb**, **Cr**. If you are using an adapter, connect these connectors to your component video cable.

2. Connect the VGA connector to the **Computer** port on the projector.

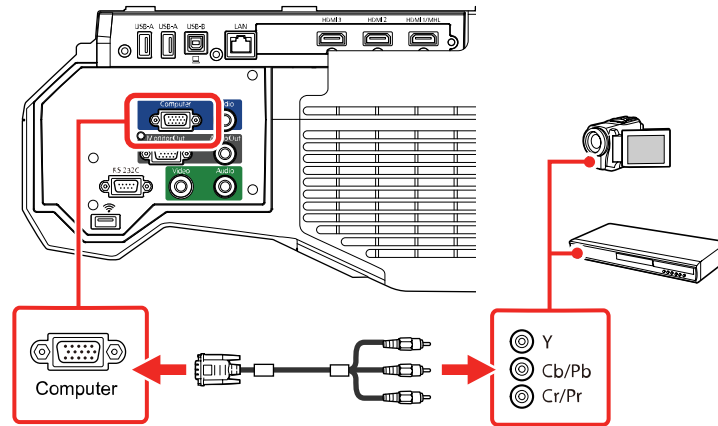

3. Tighten the screws on the VGA connector.

If your image colors appear incorrect, you may need to change the **Input Signal** setting in the projector's Signal menu.

**Parent topic:** [Connecting to Video Sources](#)

#### **Related references**

[Input Signal Settings - Signal Menu](#)

### **Connecting to a Composite Video Source**

If your video source has a composite video port, you can connect it to the projector using an optional RCA-style video or A/V cable.

1. Connect the cable with the yellow connector to your video source's yellow video output port.

2. Connect the other end to the projector's **Video** port.

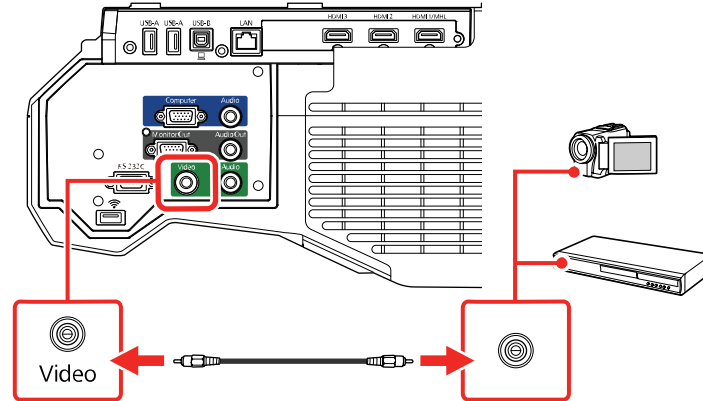

**Parent topic:** [Connecting to Video Sources](#)

### Connecting to a Video Source for Sound

You can play sound through the projector's speaker system if your video source has audio output ports. If you are projecting video using the **Video** or **Computer** port, connect the projector to the video source using an optional stereo mini-jack audio cable.

**Note:** If you connected your video source to the projector using an HDMI cable, the audio signal is transferred with the video signal; you do not need an additional cable for sound.

1. Connect the audio cable to your video source's audio-out ports.

2. Connect the other end of the cable to the projector's **Audio** port that corresponds to the port you are using for video.

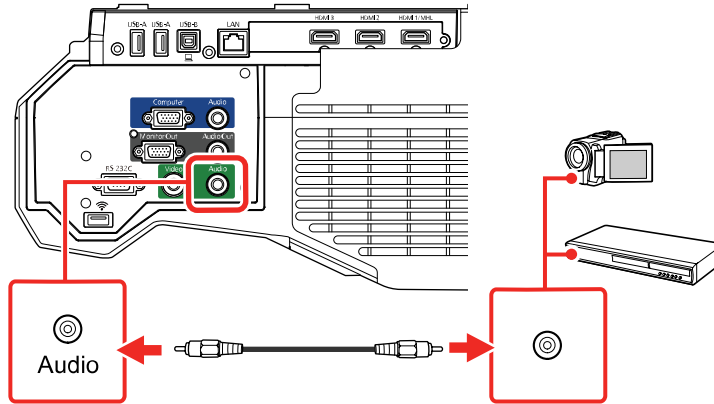

Parent topic: [Connecting to Video Sources](#)

## Connecting External Output Devices

See these sections to connect the projector to external output devices.

[Connecting to an External Computer Monitor](#)

[Connecting to External Speakers](#)

Parent topic: [Projector Connections](#)

### Connecting to an External Computer Monitor

If you connected a computer to the projector's **Computer** port, you can also connect an external monitor to the projector. This lets you see your presentation on the external monitor even when the projected image is not visible.

If you want to output images to an external monitor when the projector is turned off, you need to select **Always On** as the **A/V Output** setting in the projector's Extended menu.

**Note:** Monitors that use a refresh rate less than 60 Hz may not be able to display images correctly.

1. Make sure your computer is connected to the projector's **Computer** port.

2. Connect the external monitor's cable to your projector's **Monitor Out** port.

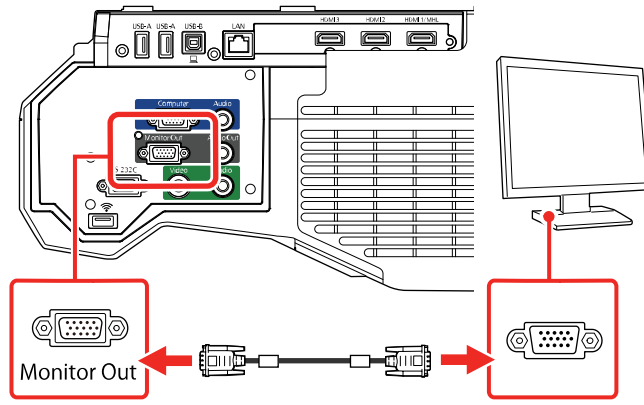

**Parent topic:** [Connecting External Output Devices](#)

### Connecting to External Speakers

To enhance the sound from your presentation, you can connect the projector to external self-powered speakers. You can control the volume using the projector's remote control.

You can also connect the projector to an amplifier with speakers.

If you want to output audio from the external speakers when the projector is turned off, you need to select **Always On** as the **A/V Output** setting in the projector's Extended menu.

**Note:** The projector's built-in speaker system is disabled when you connect external speakers.

1. Make sure your computer or video source is connected to the projector with both audio and video cables as necessary.
2. Locate the appropriate cable to connect your external speakers, such as a stereo mini-jack-to-pin-jack cable, or another type of cable or adapter.
3. Connect one end of the cable to your external speakers as necessary.

4. Connect the stereo mini-jack end of the cable to your projector's **Audio Out** port.

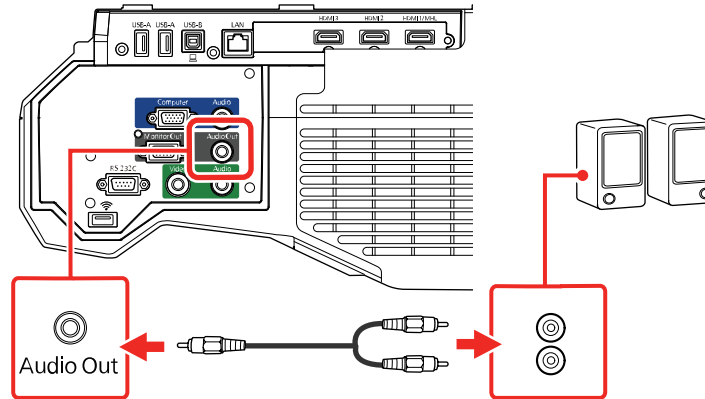

**Parent topic:** [Connecting External Output Devices](#)

**Related references**

[Projector Setup Settings - Extended Menu](#)

## Connecting to External USB Devices

Follow the instructions in these sections to connect external USB devices to the projector.

[USB Device Projection](#)

[Connecting a USB Device or Camera to the Projector](#)

[Selecting the Connected USB Source](#)

[Disconnecting a USB Device or Camera From the Projector](#)

**Parent topic:** [Projector Connections](#)

**Related tasks**

[Starting a PC Free Slide Show](#)

### USB Device Projection

You can project images and other content without using a computer or video device by connecting any of these devices to your projector:

- USB flash drive
- Digital camera or smartphone

- USB hard drive
- Multimedia storage viewer

**Note:** Digital cameras or smartphones must be USB-mounted devices, not TWAIN-compliant devices, and must be USB Mass Storage Class-compliant.

**Note:** USB hard drives must meet these requirements:

- USB Mass Storage Class-compliant (not all USB Mass Storage Class devices are supported)
- Formatted in FAT or FAT32
- Self-powered by their own AC power supplies (bus-powered hard drives are not recommended)
- Does not have multiple partitions

You can project slide shows from image files on a connected USB device.

**Parent topic:** [Connecting to External USB Devices](#)

**Related tasks**

[Starting a PC Free Slide Show](#)

### **Connecting a USB Device or Camera to the Projector**

You can connect your USB device or camera to the projector's **USB-A** port and use it to project images and other content.

1. If your USB device came with a power adapter, plug the device into an electrical outlet.



2. Connect the USB cable (or USB flash drive) to the projector's **USB-A** port.

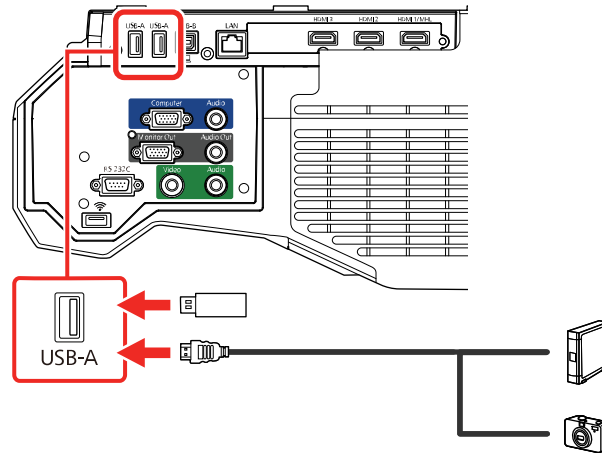

**Note:** Do not connect a USB hub or a USB cable longer than 10 feet (3 m), or the device may not operate correctly.

3. Connect the other end of the cable (if applicable) to your device.

**Parent topic:** [Connecting to External USB Devices](#)

**Related tasks**

[Starting a PC Free Slide Show](#)

**Selecting the Connected USB Source**

You can switch the projector's display to the source you connected to one of the **USB-A** ports. To display the connected USB device, select the **USB1** source.

**Note:** If you have connected a document camera, select the **USB2** source.

1. Make sure the connected USB source is turned on, if necessary.
2. Press the **Source Search** button on the remote control and select the **USB1** or **USB2** source.

**Parent topic:** [Connecting to External USB Devices](#)

**Related tasks**

[Starting a PC Free Slide Show](#)

## Disconnecting a USB Device or Camera From the Projector

When you finish presenting with a connected USB device or camera, you must prepare to disconnect the device from the projector.

1. If the device has a power button, turn off and unplug the device.
2. Disconnect the USB device or camera from the projector.

**Parent topic:** [Connecting to External USB Devices](#)

### Related tasks

[Starting a PC Free Slide Show](#)

## Connecting to a Document Camera

You can connect a document camera to your projector to project images viewed by the camera.

**Note:** If you connect a document camera to one of the **USB-A** ports on the projector, select the **USB2** source to display the image. You cannot simultaneously connect two document cameras to the **USB-A** ports.

Depending on your Epson document camera model, do one of the following to connect the document camera to your projector:

- For the Epson DC-06 document camera, locate the USB cable that came with the camera and connect it to the projector's **USB-A** port and to the document camera's USB Type B port.
- For the Epson DC-07 document camera, locate the USB cable that came with the camera and connect it to the projector's **USB-A** port and to the document camera's USB Type B port.
- For the Epson DC-11 document camera, connect it to the projector's **Computer** or **Video** port and to the corresponding port on the document camera. See the document camera manual for details.
- For the Epson DC-12 document camera, connect it to the projector's **HDMI**, **Computer**, or **Video** port and to the corresponding port on the document camera. See the document camera manual for details.
- For the Epson DC-13 document camera, connect it to the projector's **HDMI**, **Computer**, or **Video** port and to the corresponding port on the document camera. See the document camera manual for details.
- For the Epson DC-20 document camera, connect it to the projector's **HDMI**, **Computer**, or **Video** port and to the corresponding port on the document camera. See the document camera manual for details.

- For the Epson DC-21 document camera, connect it to the projector's **HDMI**, **Computer**, or **Video** port and to the corresponding port on the document camera. See the document camera manual for details.

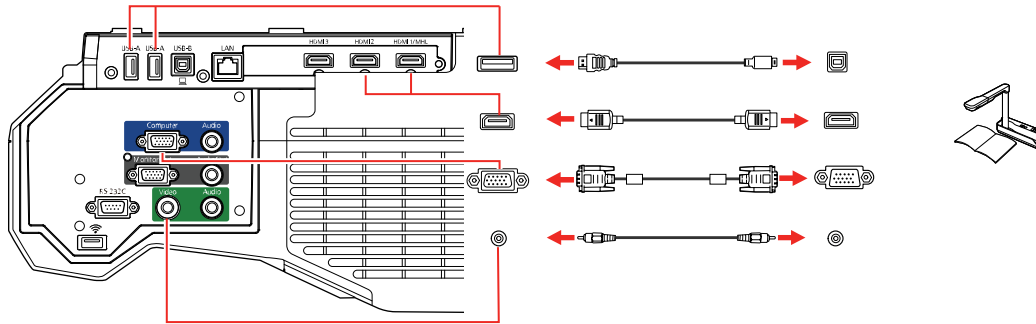

**Note:** For additional features supported by software, connect your document camera to your computer instead of the projector. See the document camera manual for details.

Parent topic: [Projector Connections](#)

## Installing Batteries in the Remote Control

The remote control uses the two AA batteries that came with the projector.

**Caution:** Use only the type of batteries specified in this manual. Do not install batteries of different types, or mix new and old batteries.

1. Remove the battery cover.

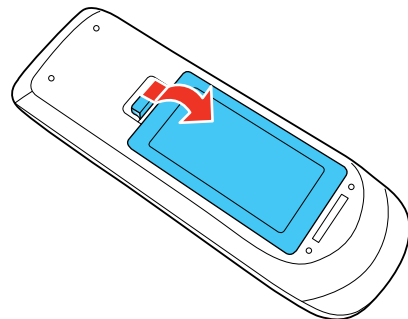

2. Insert the batteries with the + and – ends facing as shown.

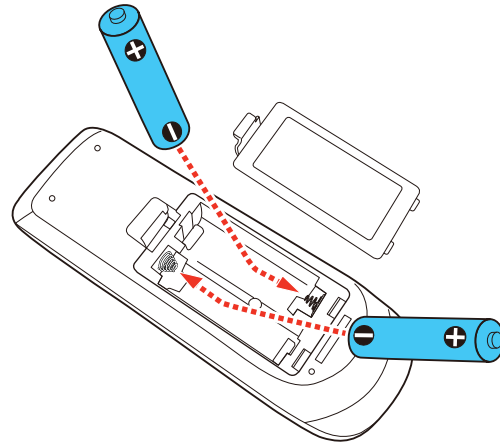

3. Replace the battery cover and press it down until it clicks into place.

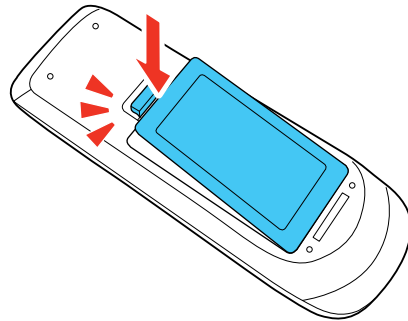

**Warning:** Dispose of used batteries according to local regulations. Do not expose batteries to heat or flame. Keep batteries out of the reach of children; they are choking hazards and are very dangerous if swallowed.

**Parent topic:** [Setting Up the Projector](#)

---

# Using the Projector on a Network

Follow the instructions in these sections to set up your projector for use on a network.

[Wired Network Projection](#)

[Wireless Network Projection](#)

[Setting Up Projector Network E-Mail Alerts](#)

[Setting Up Monitoring Using SNMP](#)

[Controlling a Networked Projector Using a Web Browser](#)

[Crestron RoomView Support](#)

[Registering a Digital Certificate on the Projector](#)

## Wired Network Projection

You can project through a wired network. To do this, you connect the projector to your network with an Ethernet cable, and then set up your projector and computer for network projection.

After connecting and setting up the projector as described here, download and install the network software and manuals as necessary.

**Note:** If your projector is connected via a LAN (Ethernet) cable to a network that includes a wireless access point, you can connect to the projector wirelessly through the access point using the Epson network software.

[Connecting to a Wired Network](#)

[Selecting Wired Network Settings](#)

**Parent topic:** [Using the Projector on a Network](#)

**Related references**

[Additional Projector Software and Manuals](#)

## Connecting to a Wired Network

To connect the projector to a wired local area network (LAN), use a 100Base-TX or 10Base-T network cable. To ensure proper data transmission, use a Category 5 shielded cable or better.

1. Connect one end of the network cable to your network hub, switch, or router.

2. Connect the other end of the cable to the projector's **LAN** port.

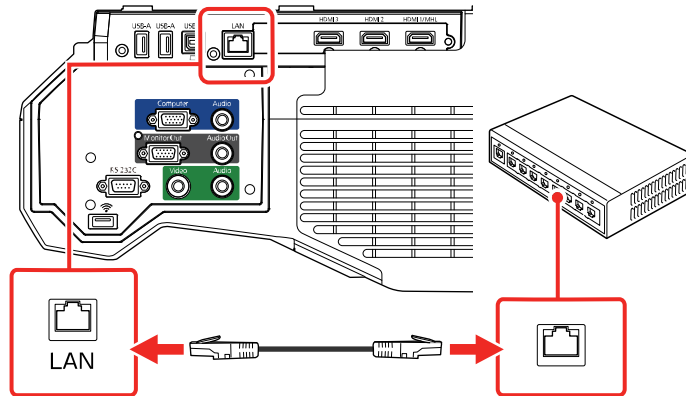

Parent topic: [Wired Network Projection](#)

## Selecting Wired Network Settings

Before you can project from computers on your network, you must select the network settings for the projector using its menu system.

**Note:** Make sure you already connected the projector to your wired network using the **LAN** port.

1. Turn on the projector.
2. Press the **Menu** button.

3. Select the **Network** menu and press **Enter**.

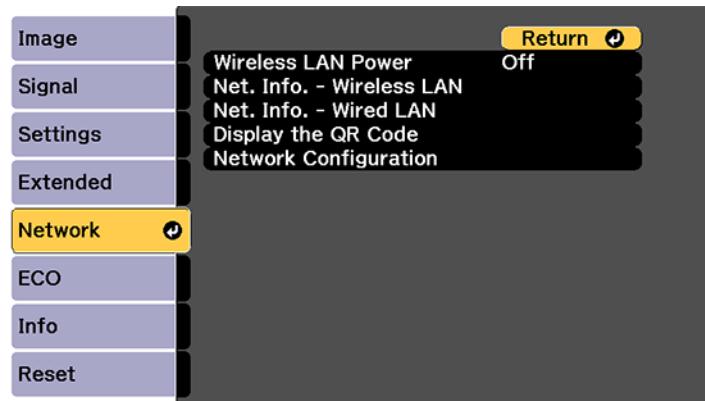

4. Select **Network Configuration** and press **Enter**.
5. Select the **Basic** menu and press **Enter**.

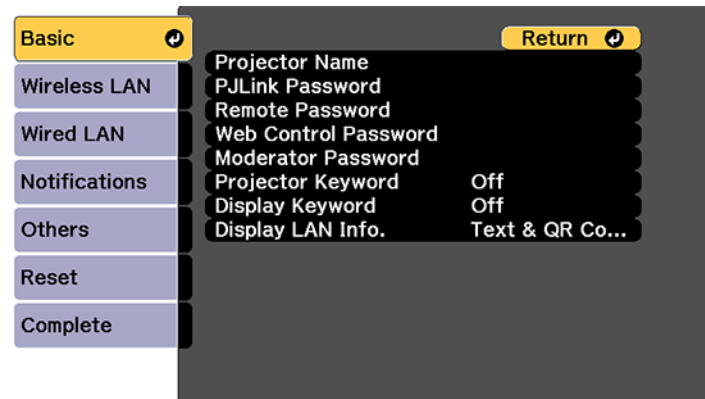

6. Select the following basic options as necessary:
  - **Projector Name** lets you enter a name up to 16 alphanumeric characters long to identify the projector over the network.
  - **PJLink Password** lets you enter a password up to 32 alphanumeric characters long for using the PJLink protocol for projector control.

- **Remote Password** lets you enter a password up to 8 alphanumeric characters long for accessing the Remote or Basic Control screen in Epson Web Control. (Default user name is **EPSONREMOTE**; default password is **guest**.)
- **Web Control Password** lets you enter a password up to 8 alphanumeric characters long for accessing the projector over the web. (Default user name is **EPSONWEB**; default password is **admin**.)
- **Moderator Password** lets you enter a password up to 4 numbers long for accessing the projector as a moderator with Epson iProjection (Windows/Mac) software or the Epson iProjection app. (No default password.)
- **Projector Keyword** lets you turn on a security password to prevent access to the projector by anyone not in the room with it. You must enter a displayed, randomized keyword from a computer using the Epson iProjection software to access the projector.
- **Display Keyword** lets you select whether or not to display a projector keyword on the projected image when using the Epson iProjection software to access the projector.
- **Display LAN Info** lets you select how the projector displays network information. You can select an option to display a QR code that lets you quickly connect your iOS or Android devices using the Epson iProjection app.

**Note:** Use the displayed keyboard to enter the name, passwords, and keyword. Press the arrow buttons on the remote control to highlight characters and press **Enter** to select them.

7. Select the **Wired LAN** menu and press **Enter**.

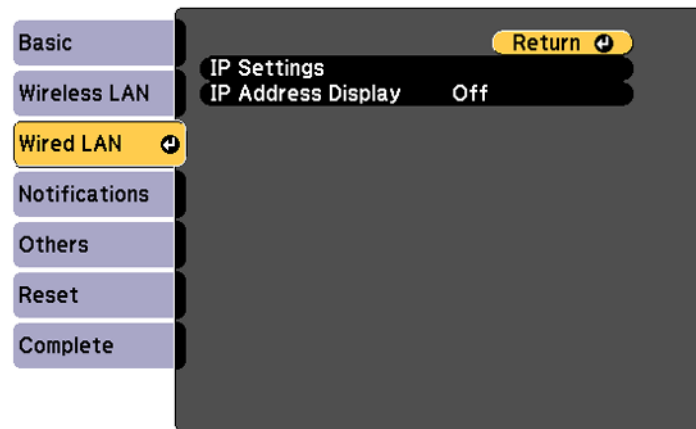



8. If necessary, select **IP Settings** and press **Enter**.
9. Select your IP Settings as necessary:
  - If your network assigns addresses automatically, turn on the **DHCP** setting.
  - If you must set addresses manually, turn off **DHCP** and enter the projector's **IP Address**, **Subnet Mask**, and **Gateway Address** as needed.

**Note:** To highlight the numbers you want from the displayed keyboard, press the arrow buttons on the remote control. To select a highlighted number, press **Enter**.

10. To prevent display of the IP address on the standby screen, turn off **IP Address Display**.
11. When you finish selecting settings, select **Complete** and follow the on-screen instructions to save your settings and exit the menus.

**Parent topic:** [Wired Network Projection](#)

## Wireless Network Projection

You can project over a wireless network. To do this, you must set up your projector and computer for wireless projection.

**Note:** The Epson 802.11b/g/n wireless LAN module is not included with your projector and is optional.

To connect wirelessly to your projector, configure the connection using the projector's Network menus. After setting up the projector as described here, download the network software and manuals as necessary.

**Note:** If your projector is connected via a LAN cable to a network that includes a wireless access point, you can connect to the projector wirelessly through the access point using the Epson network software.

[Installing the Wireless LAN Module](#)

[Connecting Directly to a Smartphone or Tablet](#)

[Using Quick Wireless Connection \(Windows\)](#)

[Selecting Wireless Network Settings Manually](#)

[Selecting Wireless Network Settings in Windows](#)

[Selecting Wireless Network Settings on Mac](#)

[Setting Up Wireless Network Security](#)

**Parent topic:** [Using the Projector on a Network](#)

**Related references**

[Additional Projector Software and Manuals](#)

[Optional Equipment and Replacement Parts](#)

## **Installing the Wireless LAN Module**

To use the projector over a wireless network, install the Epson 802.11b/g/n wireless module in the projector. Do not install any other type of wireless module.

**Caution:** Never remove the module while its indicator light is blue or flashing, or while you are projecting wirelessly. You may damage the module or lose data.

**Note:** The wireless LAN module is not included with your projector.

1. Turn off the projector and unplug the power cord.

2. Unscrew and remove the cable cover if it is attached (screwdriver not included).

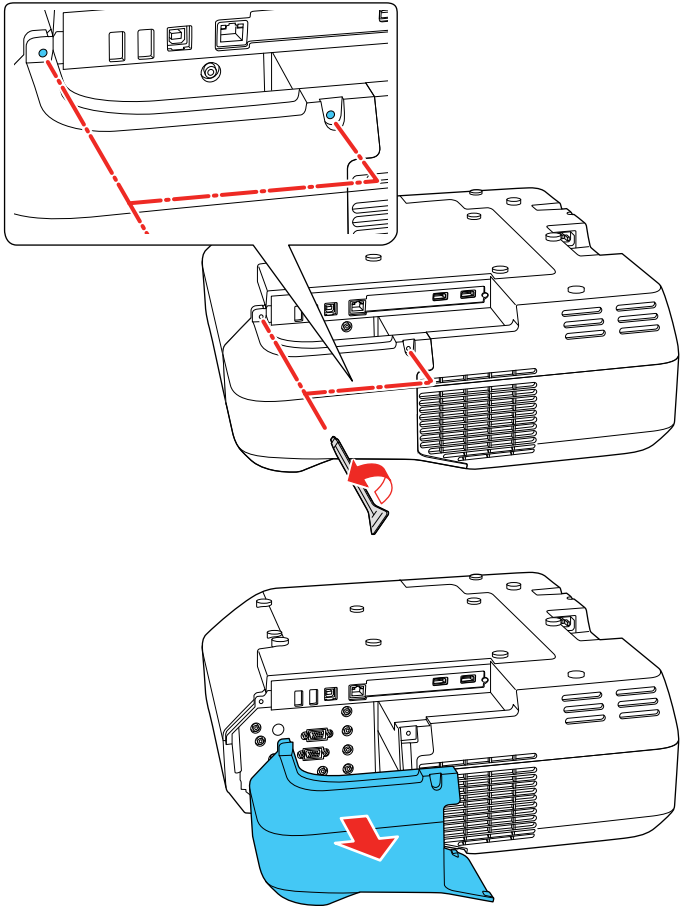

3. Insert the wireless LAN module into the port shown here.

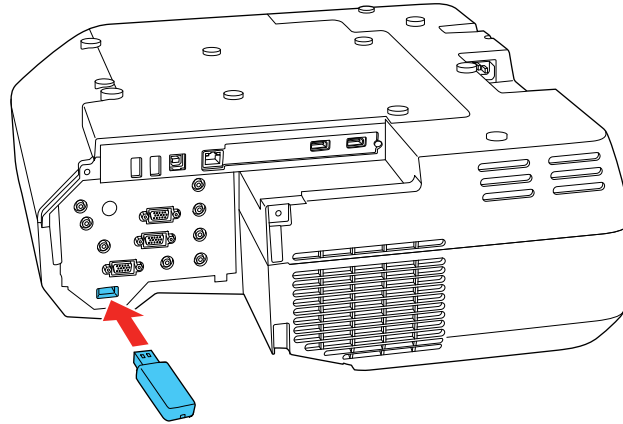

4. Replace the cable cover and tighten the screws.
5. Plug in and turn on the projector.

Parent topic: [Wireless Network Projection](#)

## Connecting Directly to a Smartphone or Tablet

You can display a QR code on the screen and use it to connect a single smartphone or tablet to your projector with the Epson iProjection app.

1. Download the latest version of Epson iProjection from the App Store or Google Play and install it on your smartphone or tablet.
2. Press the **Menu** button on the projector or the remote control.

3. Select the **Network** menu and press **Enter**.

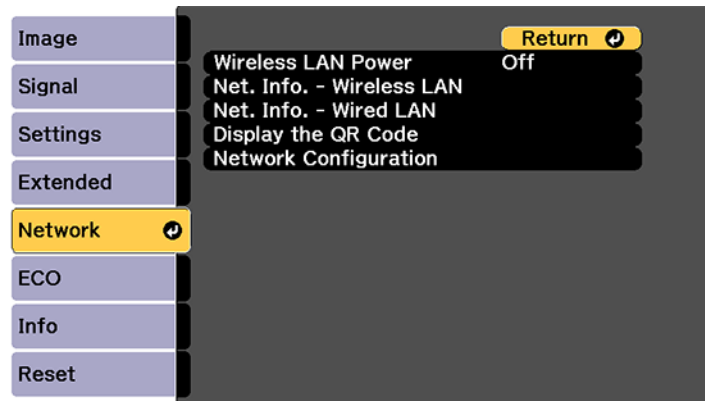

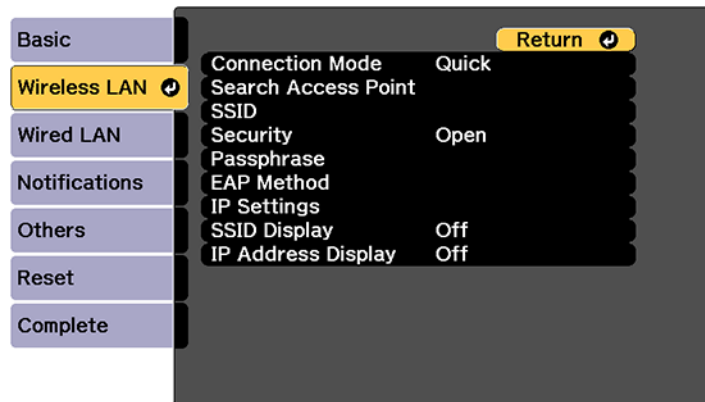

4. Select **On** as the **Wireless LAN Power** setting, if necessary.
5. Select **Network Configuration** and press **Enter**.
6. Select the **Wireless LAN** menu and press **Enter**.

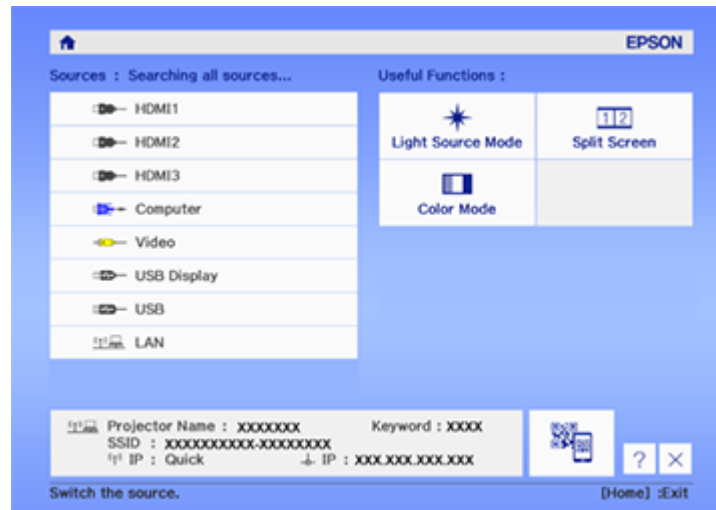

7. Select **Connection Mode** and press **Enter**.
8. Select **Quick** and press **Enter**, then press **Enter** again.

- When you finish selecting settings, select **Complete** and follow the on-screen instructions to save your settings and exit the menus.
- Press the **Home** button on the projector or the remote control.



- Select the QR code icon  and press **Enter**.
- Your projector displays a QR code on the projection surface.
- Open the Epson iProjection app on your smartphone or tablet.
- Use the QR code reader feature to read the QR code and connect your device to the projector.

**Note:** The projector and the smartphone must be on the same wireless network in order to establish a connection.

Your smartphone or tablet is now connected to your projector. Visit [epson.com/iprojection](https://www.epson.com/iprojection) (U.S.) or [epson.ca/iprojection](https://www.epson.ca/iprojection) (Canada) for information on controlling your projector with the Epson iProjection app.

**Parent topic:** [Wireless Network Projection](#)

## Using Quick Wireless Connection (Windows)

You can create a Quick Wireless Connection USB Key to quickly connect the projector to a Windows computer wirelessly. Then you can project your presentation and remove the key when you are done.

**Note:** A USB flash drive is not included with your projector.

1. Create a Quick Wireless Connection USB Key with a USB flash drive and the Epson iProjection (Windows/Mac) software.

**Note:** See the online *Epson iProjection Operation Guide* for instructions.

2. Make sure the wireless LAN module is installed in your projector.
3. Turn on the projector.
4. Press the **LAN** button on the remote control.  
The LAN standby screen is displayed.
5. Verify the SSID and IP address.
6. Insert the USB key into the projector's **USB-A** port.

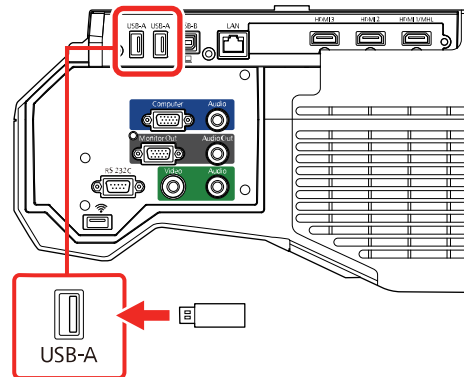

You see a projected message that the network information update is complete.

7. Remove the USB key.

8. Insert the USB key into a USB port on your computer.

**Note:** In Windows Vista, if you see the AutoPlay window, select **Run MPPLaunch.exe**, then select **Allow** on the next screen.

9. Follow the on-screen instructions to install the Epson iProjection (Windows/Mac) software.

**Note:** If you see a Windows Firewall message, click **Yes** to disable the firewall. You need administrator authority to install the software. If it is not installed automatically, double-click **MPPLaunch.exe** in the USB key.

After a few minutes, your computer image is displayed by the projector. If it does not appear, press the **LAN** or **Source Search** button on your remote control or restart your computer.

10. Run your presentation as necessary.
11. When you finish projecting wirelessly, select the **Safely Remove Hardware** option in the Windows taskbar, then remove the USB key from your computer.

**Note:** You can share the USB key with other computers without disconnecting your computer. You may need to restart your computer to reactivate your wireless LAN connection.

**Parent topic:** [Wireless Network Projection](#)

**Related references**

[Additional Projector Software and Manuals](#)

## Selecting Wireless Network Settings Manually

Before you can project from your wireless network, you must select the network settings for the projector using its menu system.

1. Turn on the projector.
2. Press the **Menu** button.



3. Select the **Network** menu and press **Enter**.

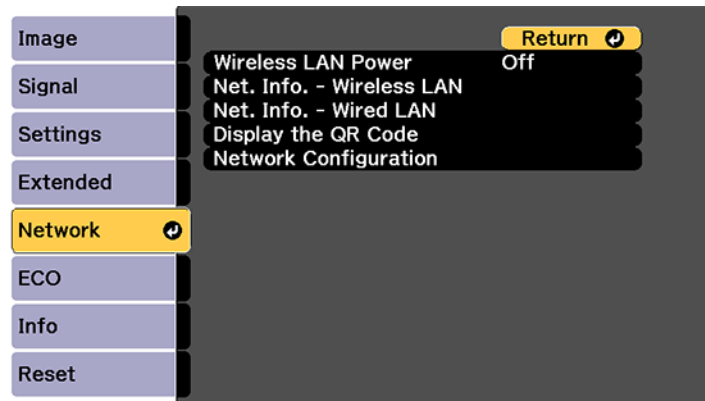

4. Make sure the **Wireless LAN Power** setting is set to **On**.
5. Select **Network Configuration** and press **Enter**.
6. Select the **Basic** menu and press **Enter**.

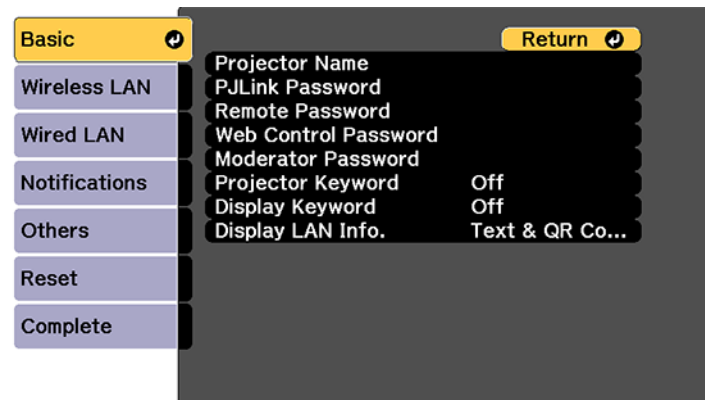

7. Select the following basic options as necessary:
  - **Projector Name** lets you enter a name up to 16 alphanumeric characters long to identify the projector over the network.

- **PJLink Password** lets you enter a password up to 32 alphanumeric characters long for using the PJLink protocol for projector control.
- **Remote Password** lets you enter a password up to 8 alphanumeric characters long for accessing the Remote or Basic Control screen in the Epson Web Control. (Default user name is **EPSONREMOTE**; default password is **guest**.)
- **Web Control Password** lets you enter a password up to 8 alphanumeric characters long for accessing the projector over the web. (Default user name is **EPSONWEB**; default password is **admin**.)
- **Moderator Password** lets you enter a password up to 4 numbers long for accessing the projector as a moderator with Epson iProjection software or the Epson iProjection app.
- **Projector Keyword** lets you turn on a security password to prevent access to the projector by anyone not in the room with it. The projector displays a random keyword that you must enter from a computer using the Epson iProjection software or an iOS or Android device using the Epson iProjection app.
- **Display Keyword** lets you display a keyword on the projected image when accessing the projector from a computer using the Epson iProjection software or an iOS or Android device using the Epson iProjection app.
- **Display LAN Info** lets you select how the projector displays network information. You can select an option to display a QR code that lets you quickly connect your iOS or Android devices with Epson iProjection (Windows/Mac) software or the Epson iProjection app.

**Note:** Use the displayed keyboard to enter the name, passwords and keyword. Press the arrow buttons on the remote control to highlight characters and press **Enter** to select them.

8. Select the **Wireless LAN** menu and press **Enter**.

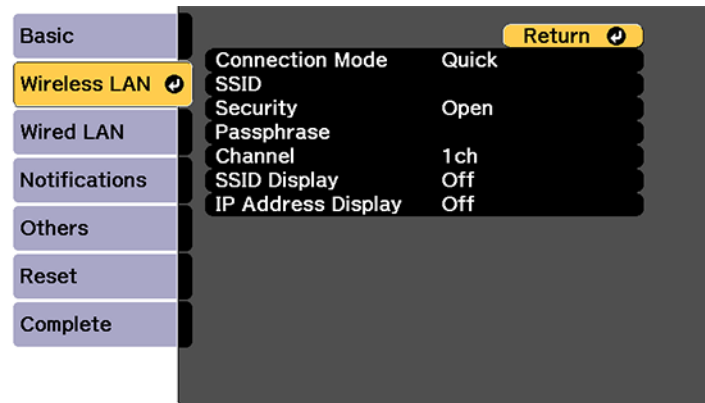

9. Select the settings on the **Wireless LAN** menu as necessary for your network.
10. When you finish selecting settings, select **Complete** and follow the on-screen instructions to save your settings and exit the menus.

**Note:** Check your network security settings after completing the wireless settings.

After you complete the wireless settings for your projector, you need to select the wireless network on your computer, or iOS or Android device.

[Wireless LAN Menu Settings](#)

**Parent topic:** [Wireless Network Projection](#)

## Wireless LAN Menu Settings

Setting	Options	Description
<b>Connection Mode</b>	<b>Quick</b> <b>Advanced</b>	Selects the type of wireless connection: <b>Quick:</b> lets you directly connect to multiple devices and computers using the projector's wireless network (requires the optional wireless LAN module). <b>Advanced:</b> lets you connect to multiple devices and computers via a wireless network access point
<b>Search Access Point</b>	<b>To Search View</b>	Search for available wireless network access points in <b>Advanced</b> connection mode
<b>SSID</b>	Up 32 alphanumeric characters	Sets the SSID (network name) of the wireless LAN system the projector is connecting to

Setting	Options	Description
<b>Security</b>	<b>Open</b> <b>WPA2-PSK</b> <b>WPA/WPA2-PSK</b> <b>WPA2-EAP</b> <b>WPA/WPA2-EAP</b>	Selects the type of security used on the wireless network <b>WPA2-PSK</b> : uses WPA2 security with AES for encryption. Use the <b>Passphrase</b> value to establish a connection from a computer <b>WPA/WPA2-PSK</b> : uses WPA personal mode; encryption is dependent on the access point settings; <b>Passphrase</b> must be the same as the access point <b>WPA2-EAP</b> : uses WPA2 security with AES for encryption <b>WPA/WPA2-EAP</b> : uses WPA enterprise mode; encryption is dependent on the access point settings
<b>Passphrase</b>	Various passphrases from 8 to 32 characters (from a web browser, the maximum is 63 characters)	Selects the pre-shared key used on the network; passphrases are case-sensitive. If the network settings are reset after the passphrase has been changed more than once, the first passphrase is restored.
<b>EAP Method</b>	<b>EAP Type</b> <b>User name</b> <b>Password</b> <b>Client Certificate</b> <b>Verify Server Cert.</b> <b>CA Certificate</b> <b>RADIUS Server Name</b>	Sets the EAP settings for WPA2-EAP and WPA/WPA2-EAP security

Setting	Options	Description
<b>Channel</b>	1ch 6ch 11ch	In <b>Quick</b> connection mode, selects the frequency band (channel) used by the wireless LAN
<b>IP Settings</b>	<b>DHCP (On or Off)</b> <b>IP Address</b> <b>Subnet Mask</b> <b>Gateway Address</b>	Selects DHCP if your network assigns IP addresses automatically, or turns off DHCP so you can enter the network's IP address, subnet mask, and gateway address as needed
<b>SSID Display</b>	<b>On</b> <b>Off</b>	Selects whether to display the SSID on the network standby screen and Home screen
<b>IP Address Display</b>	<b>On</b> <b>Off</b>	Selects whether to display the IP address on the network standby screen and Home screen

Parent topic: [Selecting Wireless Network Settings Manually](#)

## Selecting Wireless Network Settings in Windows

Before connecting to the projector, select the correct wireless network on your computer.

1. To access your wireless utility software, access the Desktop and double-click the network icon on the Windows taskbar.
2. Do one of the following:
  - If your projector is set up on an existing network (Advanced mode), select the network name (SSID).
  - If your projector is configured for Quick mode, select the projector's SSID.
3. Click **Connect**.

Parent topic: [Wireless Network Projection](#)

## Selecting Wireless Network Settings on Mac

Before connecting to the projector, select the correct wireless network on your Mac.

1. Click the AirPort icon on the menu bar at the top of the screen.

2. Make sure AirPort is turned on, then do one of the following:
  - If your projector is set up on an existing network (Advanced mode), select the network name (SSID).
  - If your projector is configured for Quick mode, select the projector's SSID.

Parent topic: [Wireless Network Projection](#)

## Setting Up Wireless Network Security

You can set up security for your projector to use on a wireless network. Set up one of the following security options to match the settings used on your network:

- WPA2-PSK
- WPA2-EAP\*
- WPA/WPA2-PSK\*
- WPA/WPA2-EAP\*

\* Only available for **Advanced** connection mode.

**Note:** Contact your network administrator for guidance on entering the correct information.

1. If you want to set up WPA2-EAP or WAP/WAP2-EAP security, make sure your digital certificate file is compatible with projector registration and placed directly on the USB storage device.
2. Press the **Menu** button.
3. Select the **Network** menu and press **Enter**.

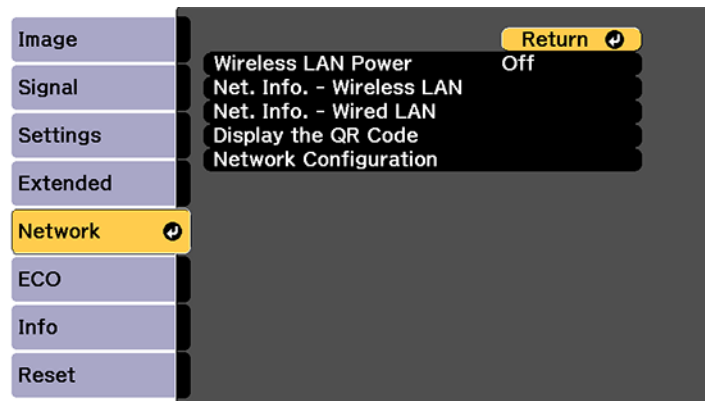

4. Select **Network Configuration** and press **Enter**.
5. Select the **Wireless LAN** menu and press **Enter**.
6. Select the **Security** setting and press **Enter**.
7. Select the security settings for your network.
8. When you finished, select **Complete** and follow the on-screen instructions to save your settings and exit the menus.

Parent topic: [Wireless Network Projection](#)

## Setting Up Projector Network E-Mail Alerts

You can set up the projector to send you an e-mail alert over the network if there is a problem with the projector.

1. Press the **Menu** button.
2. Select the **Network** menu and press **Enter**.
3. Select **Network Configuration** and press **Enter**.
4. Select the **Notifications** menu and press **Enter**.

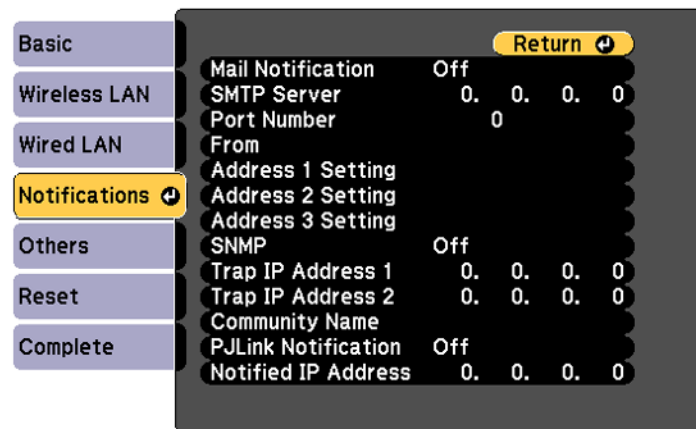

5. Turn on **Mail Notification**.



6. Enter the IP address for the **SMTP Server** setting.

**Note:** To enter the IP address using the numeric keys on the remote control, press and hold the **Num** button. Do not use these addresses: 127.x.x.x or 224.0.0.0 through 255.255.255.255 (where x is a number from 0 to 255).

7. Select a number for the SMTP server **Port Number** setting, from 1 to 65535 (default is 25).
8. Enter the sender's email address as the **From** setting.
9. Choose an **Address** field, enter the e-mail address, and select the alerts you want to receive there. Repeat for up to three addresses. Your e-mail address can be up to 32 alphanumeric characters long.
10. If you are using the PJLink protocol for projector control, turn on the **PJLink Notification** setting and enter the IP address where you want to receive PJLink notifications as the **Notified IP Address** setting.
11. When you finish selecting settings, select **Complete** and follow the on-screen instructions to save your settings and exit the menus.

**Note:** If a critical problem causes a projector to shut down, you may not receive an e-mail alert.

[Network Projector E-mail Alert Messages](#)

**Parent topic:** [Using the Projector on a Network](#)

## Network Projector E-mail Alert Messages

When a problem occurs with a networked projector, and you selected to receive e-mail alerts, you receive an e-mail containing the following information:

- The email address entered as the **From** setting
- **Epson Projector** on the subject line
- The name of the projector experiencing a problem
- The IP address of the affected projector
- Detailed information about the problem

**Note:** If a critical problem causes a projector to shut down, you may not receive an e-mail alert.

**Parent topic:** [Setting Up Projector Network E-Mail Alerts](#)

## Setting Up Monitoring Using SNMP

Network administrators can install SNMP (Simple Network Management Protocol) software on network computers so they can monitor projectors. If your network uses this software, you can set up the projector for SNMP monitoring.

1. Press the **Menu** button.
2. Select the **Network** menu and press **Enter**.
3. Select **Network Configuration** and press **Enter**.
4. Select the **Notifications** menu and press **Enter**.

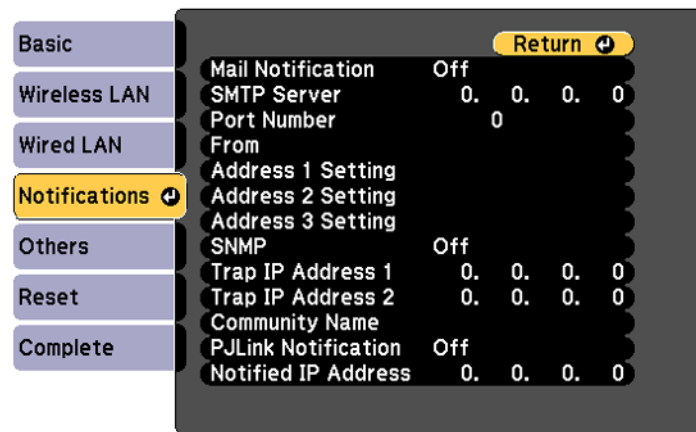

5. Turn on the **SNMP** setting.
6. Enter up to two IP addresses to receive SNMP notifications as the **Trap IP Address** setting, using 0 to 255 for each address field.

**Note:** To enter the IP address using the numeric keys on the remote control, press and hold the **Num** button. Do not use these addresses: 127.x.x.x or 224.0.0.0 through 255.255.255.255 (where x is a number from 0 to 255).

7. Select the **Others** menu and press **Enter**.

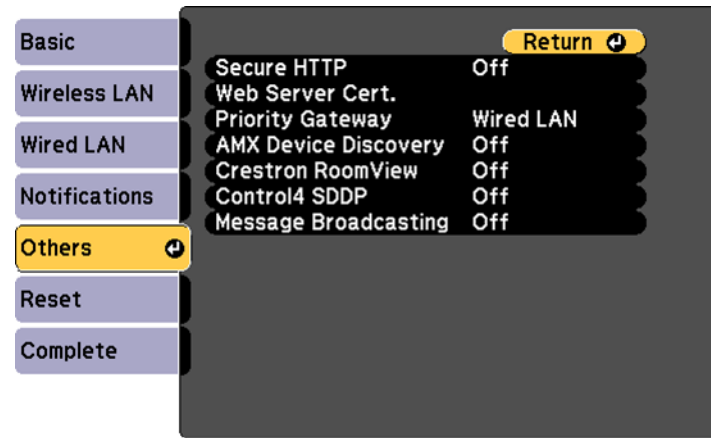

8. If you want to use the Secure HTTP protocol to encrypt communication when using Web Control, turn on the **Secure HTTP** setting and import the web server certificate using the **Web Server Cert.** setting.
9. If available, select the **Priority Gateway** setting for your network.
10. If your network environment uses an AMX controller, turn on the **AMX Device Discovery** setting to allow the projector to be detected.
11. If your network environment uses a Crestron RoomView controller, turn on the **Crestron RoomView** setting to allow the projector to be detected.
12. If you are using the projector with a Control 4 Simple Device Discovery Protocol (SDDP) automation system, turn on the **Control4 SDDP** setting.
13. If you want this projector to receive broadcast messages over the network, turn on the **Message Broadcasting** setting. Administrators can broadcast messages over the network using the Epson Projector Management software.
14. When you finish selecting settings, select **Complete** and follow the on-screen instructions to save your settings and exit the menus.

**Parent topic:** [Using the Projector on a Network](#)

## Controlling a Networked Projector Using a Web Browser

Once you have connected your projector to your network, you can select projector settings and control projection using a compatible web browser. This lets you access the projector remotely.

**Note:** The web setup and control features support Microsoft Internet Explorer 11.0 or later, Microsoft Edge, Google Chrome, and Safari on networks that do not use a proxy server for connection. You cannot select all of the projector menu settings or control all projector functions using a web browser.

**Note:** If you set Standby Mode to **Communication On** in the ECO menu, you can use a web browser to select settings and control projection even if the projector is in standby mode.

1. Make sure the projector is turned on.
2. Start your web browser on a computer or device connected to the network.
3. Type the projector's IP address into the browser's address box and press the computer's **Enter** key.

**Note:** If you attempt to connect to the Web Control screen via a proxy server, the screen will not be displayed. Make a direct connection to the Web Control screen.

You see the Web Control screen.

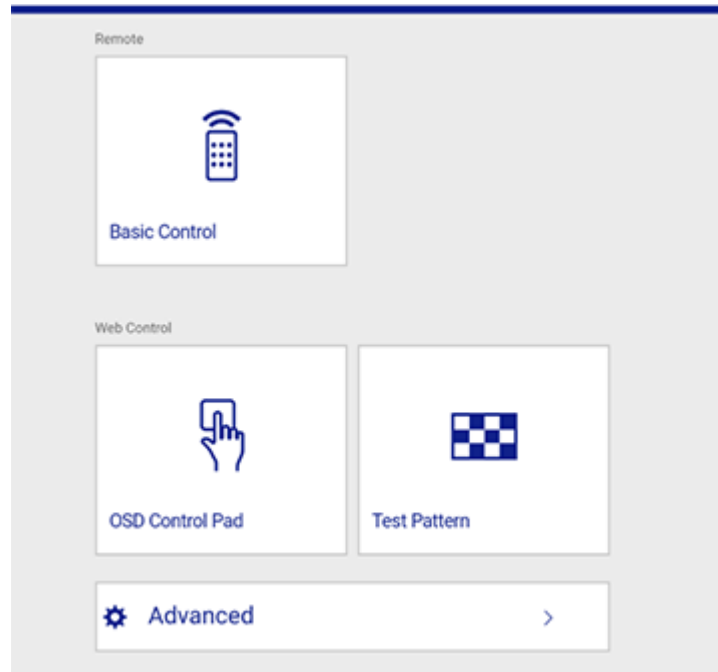

4. To control projection remotely, select the **Basic Control** option from the Web Control screen.

**Note:** If you see a log in window, enter your user name and password. (The default user name is **EPSONREMOTE** and the default password is **guest**.)

You see a screen like this:

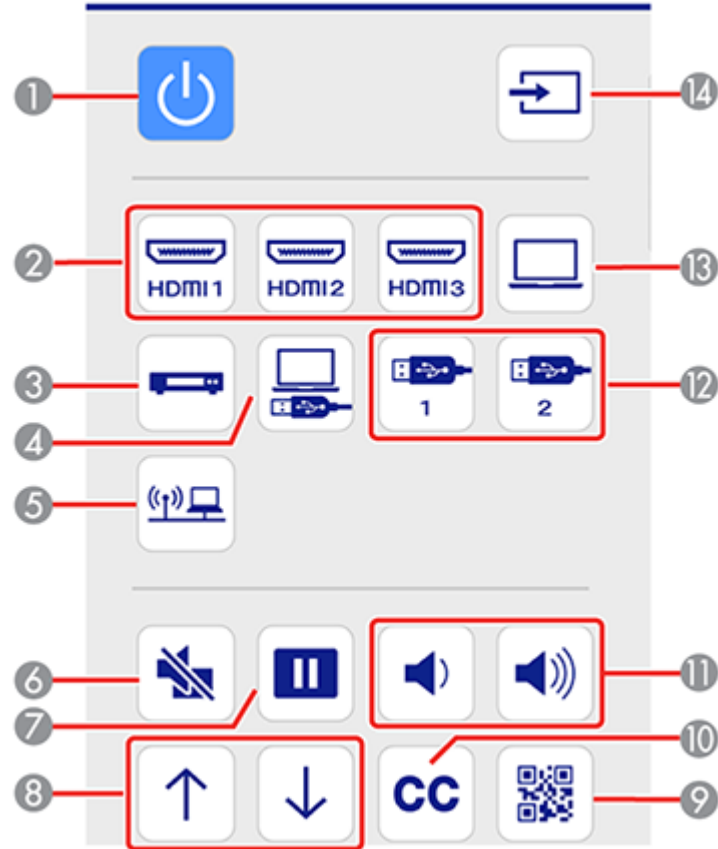

- 1 Power button control
- 2 Selects an **HDMI** port source
- 3 Selects a **Video** port source
- 4 Selects the USB Display source
- 5 Selects the network source
- 6 **A/V Mute** button control

- 7 **Freeze** button control
  - 8 **Page Up** and **Page Down** button controls
  - 9 Displays a QR code for connecting with iOS or Android devices using the Epson iProjection app
  - 10 Displays closed captions
  - 11 **Volume** button controls
  - 12 Selects the USB device source
  - 13 Selects the **Computer** port source
  - 14 Searches for connected sources
5. Select the icon corresponding to the projector function you want to control.
  6. To select projector menu settings, select **Advanced** on the Web Control screen.

**Note:** If you see a log in window, enter your user name and password. (The default user name is **EPSONWEB** and the default password is **admin**.)

7. Select the name of the menu and follow the on-screen instructions.

**Parent topic:** [Using the Projector on a Network](#)

## Crestron RoomView Support

If you are using the Crestron RoomView network monitoring and control system, you can set up your projector for use on the system. Crestron RoomView lets you control and monitor your projector using a web browser.

**Note:** You cannot use the Epson Web Control feature or the Message Broadcasting tool for Epson Projector Management when you use Crestron RoomView.

For additional information on Crestron RoomView, contact Crestron.

[Setting Up Crestron RoomView Support](#)

[Controlling a Networked Projector Using Crestron RoomView](#)

**Parent topic:** [Using the Projector on a Network](#)

## Setting Up Crestron RoomView Support

To set up your projector for monitoring and control using a Crestron RoomView system, make sure your computer and projector are connected to the network. If you are connecting wirelessly, set up the projector using the Advanced network connection mode.

**Note:** If you want to use the Crestron RoomView system when the projector is turned off, you need to adjust the **Standby Mode** setting in the ECO menu.

1. Press the **Menu** button.
2. Select the **Network** menu and press **Enter**.
3. Select **Network Configuration** and press **Enter**.
4. Select the **Others** menu and press **Enter**.

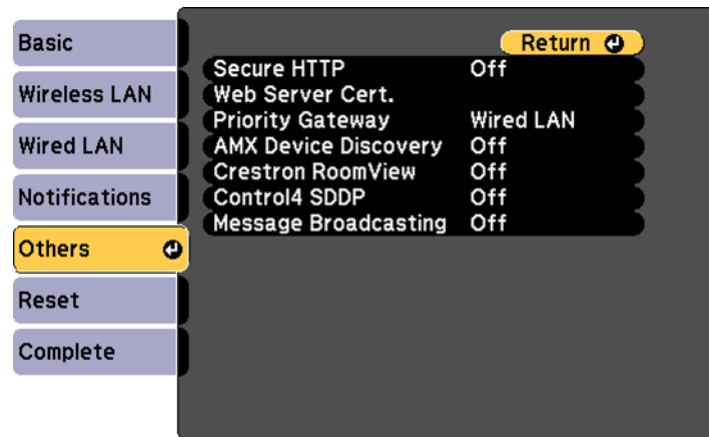

5. Set the **Crestron RoomView** setting to **On** to allow the projector to be detected.

**Note:** Enabling Crestron RoomView disables the Epson Message Broadcasting feature in the Epson Projector Management software.

6. When you finish selecting settings, select **Complete** and follow the on-screen instructions to save your settings and exit the menus.
7. Turn off the projector, then turn it on again to enable the setting.



Parent topic: [Crestron RoomView Support](#)

### Related references

[Projector Setup Settings - ECO Menu](#)

## Controlling a Networked Projector Using Crestron RoomView

Once you have set up your projector to use Crestron RoomView, you can control and monitor projection using a compatible web browser.

1. Start your web browser on a computer connected to the network.
2. Type the projector's IP address into the browser's address box and press the computer's **Enter** key.

You see this screen:



3. Select the input source that you want to control in the Sources List box. You can scroll through available sources using the up and down arrows in the box.
4. To control projection remotely, click the on-screen buttons that correspond to the projector's remote control buttons. You can scroll through button options at the bottom of the screen.

**Note:** These on-screen buttons do not directly correspond to the projector's remote control buttons:

- **OK** acts as the **Enter** button
- **Menu** displays the projector's menu

5. To view information about the projector, click the **Info** tab.

6. To change projector, Crestron, and password settings, click the **Tools** tab, select settings on the displayed screen, and click **Send**.
7. When you finish selecting settings, click **Exit** to exit the program.

**Parent topic:** [Crestron RoomView Support](#)

## Registering a Digital Certificate on the Projector

Follow the instructions here if you need to install a digital certificate on the projector to provide security for your presentation files.

**Note:** You can register a digital certificate over a network. However, be sure to register just once or the certificate may not install correctly.

[Importing a Web Server Certificate Using the Projector Menus](#)

[Registering Digital Certificates from a Web Browser](#)

[Digital Certificate Types](#)

**Parent topic:** [Using the Projector on a Network](#)

## Importing a Web Server Certificate Using the Projector Menus

You can create your web server certificate and import it using the projector menus and a USB flash drive.

**Note:** You can also register digital certificates from your web browser. Make sure to only register once, or the certificate may not install correctly.

1. Make sure your digital certificate file is compatible with projector registration and saved in the root directory of the USB flash drive.
2. Press the **Menu** button on the projector or remote control.

3. Select the **Network** menu and press **Enter**.

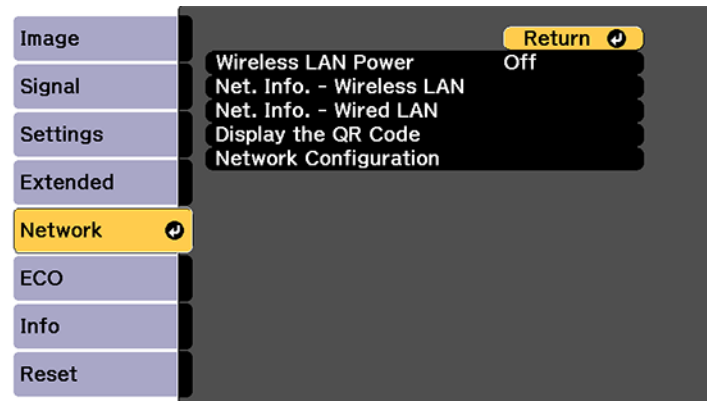

4. Select the **Network Configuration** setting and press **Enter**.
5. Select the **Others** menu and press **Enter**.

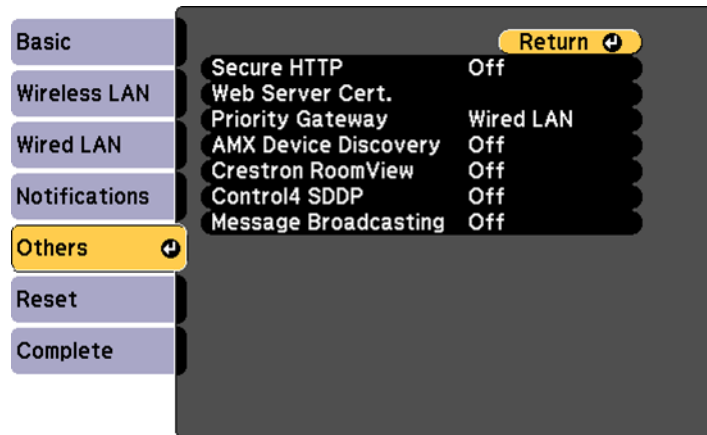

6. Select **On** as the **Secure HTTP** setting.
7. Select the **Web Server Cert.** setting and press **Enter**.
8. Select **Register** and press **Enter**.
9. Follow the on-screen instructions to connect a USB flash drive to the projector's **USB-A** port.

10. Press **Enter** to display the certificate list.
11. Select the certificate you want to import from the displayed list.  
A message is displayed prompting you to enter the password for the certificate.
12. Enter the password and press **Enter**.

The certificate is imported and a completion message appears.

**Parent topic:** [Registering a Digital Certificate on the Projector](#)

## Registering Digital Certificates from a Web Browser

You can register the digital certificates on the projector for wireless LAN authentication.

1. Make sure your digital certificate file is compatible with projector registration.
2. Make sure the projector is turned on.
3. Start your web browser on a computer connected to the network.
4. Type the projector's IP address into the browser's address box and press the computer's **Enter** key.  
You see the Web Control screen.
5. Select **Advanced**.
6. Enter the following information in uppercase or lowercase letters, exactly as shown:
  - For the user ID, enter **EPSONWEB**. (You cannot change the user ID.)
  - For the password, enter the default password **admin**. (You can change the Web Control password using the projector's Network menu.)
7. Under **Network**, select the **Certificate** option.

You see a screen like this:

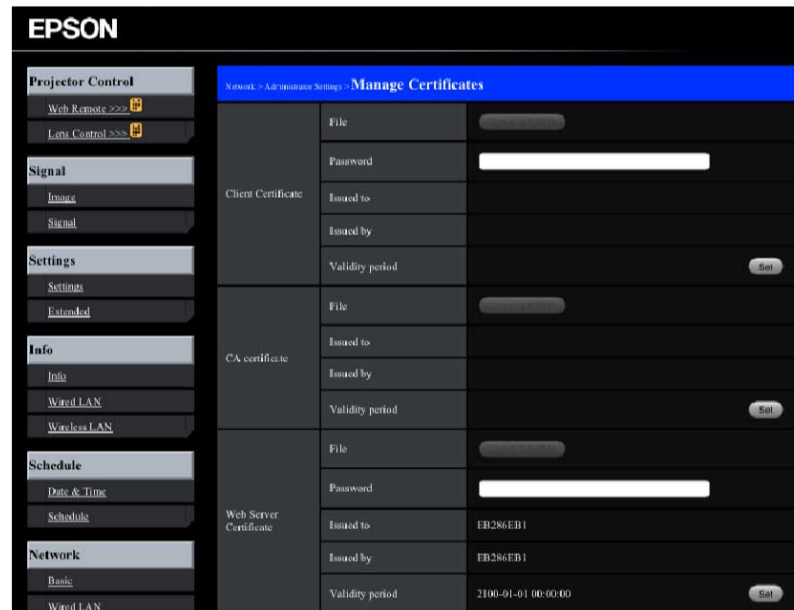

8. Select the certificate file you want to register.
9. Enter a password in the **Password** box, then click **Send**.
10. When you finish registering the certificate, click **Apply** to finalize your changes and complete the registration.

**Parent topic:** [Registering a Digital Certificate on the Projector](#)

## Digital Certificate Types

You can register these types of digital certificates.

### Client Certificate (PEAP-TLS/EAP-TLS)

Specification	Description
Format	PKCS#12
Extension	PFX/P12

Specification	Description
Encryption	RSA
Hashes	MD5/SHA-1/SHA-256/SHA-384/SHA-512
Key length	512/1024/2048/4096 bit
Password	Up to 32 alphanumeric characters; required

#### CA Certificate (PEAP/PEAP-TLS/EAP-TLS/EAP-Fast)

Specification	Description
Format	X509v3
Extension	DER/CER/PEM
Encryption	RSA
Hashes	MD5/SHA-1/SHA-256/SHA-384/SHA-512
Key length	512/1024/2048/4096 bit
Encoding	BASE64/Binary

#### Web Server Certificate (Secure HTTP)

Specification	Description
Format	PKCS#12
Extension	PFX/P12
Encryption	RSA
Hashes	MD5/SHA-1/SHA-256/SHA-384/SHA-512
Key length	512/1024/2048/4096 bit
Common name	Network host name
Organization	Optional
Password	Up to 32 alphanumeric characters; required

Parent topic: [Registering a Digital Certificate on the Projector](#)

---

# Using Basic Projector Features

Follow the instructions in these sections to use your projector's basic features.

[Turning On the Projector](#)

[Turning Off the Projector](#)

[Selecting the Language for the Projector Menus](#)

[Setting the Date and Time](#)

[Image Shape](#)

[Adjusting the Image Height](#)

[Resizing the Image with the Wide and Tele Buttons](#)

[Adjusting the Image Position](#)

[Focusing the Image](#)

[Remote Control Operation](#)

[Selecting an Image Source](#)

[Projection Modes](#)

[Image Aspect Ratio](#)

[Color Mode](#)

[Controlling the Volume with the Volume Buttons](#)

[Projecting a PC Free Presentation](#)

## Turning On the Projector

Turn on the computer or video equipment you want to use before you turn on the projector so it can display the image source.

1. Connect the power cord to the projector's power inlet.

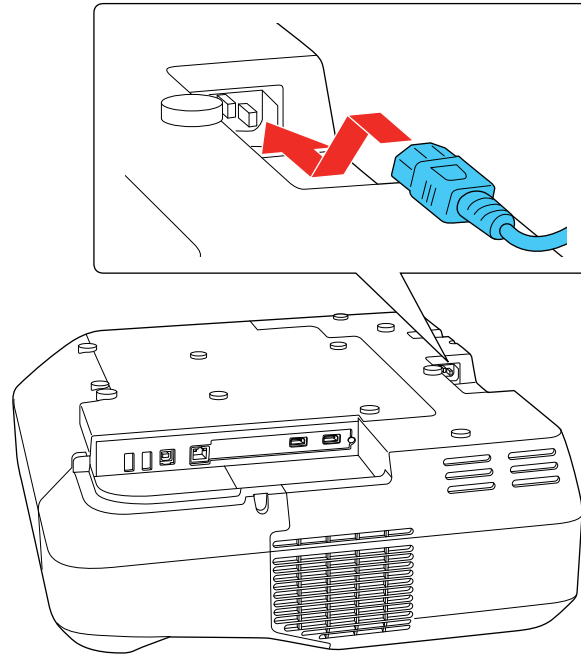

2. Plug the power cord into an electrical outlet.  
The projector's On/Standby light turns blue. This indicates that the projector is receiving power.

**Note:** With **Direct Power On** turned on, the projector turns on as soon as you plug it in.

3. Press the power button on the projector, or remote control to turn on the projector.  
The projector beeps and the Status light flashes blue as the projector warms up. After about 30 seconds, the Status light stops flashing and turns blue.

**Warning:** Never look into the projector lens when the laser is on. This can damage your eyes and is especially dangerous for children and pets.



**Caution:** Make sure no objects are blocking the light from the projector lens. Objects blocking the lens for an extended time can melt and light that is reflected back into the lens can cause the projector to malfunction.

**Note:** If the **Auto Source Search** setting in the Extended menu is enabled, the projector automatically detects the input signal when you turn it on.

If you do not see a projected image right away, try the following:

- Turn on the connected computer or video device.
- Insert a DVD or other video media and press the play button, if necessary.
- Press the **Source Search** button on the projector, or remote control to detect the video source.
- Change the screen output from the computer when using a laptop.
- Press the button for the video source on the remote control.
- If the Home screen is displayed, select the source you want to project.

[Using the Home Screen](#)

**Parent topic:** [Using Basic Projector Features](#)

**Related references**

[Projector Setup Settings - Extended Menu](#)

## Using the Home Screen

You can select input sources and other frequently used options from the Home screen.

1. To display the Home screen, do one of the following:
  - Press the **Home** button on the control panel or remote control.
  - Turn on the projector with the **Home Screen Auto Disp** setting enabled.
  - Turn on the projector when no signal is received from the selected input source.

2. Press the arrow buttons on the remote control or control panel to navigate the screen, and press **Enter** to select an option.

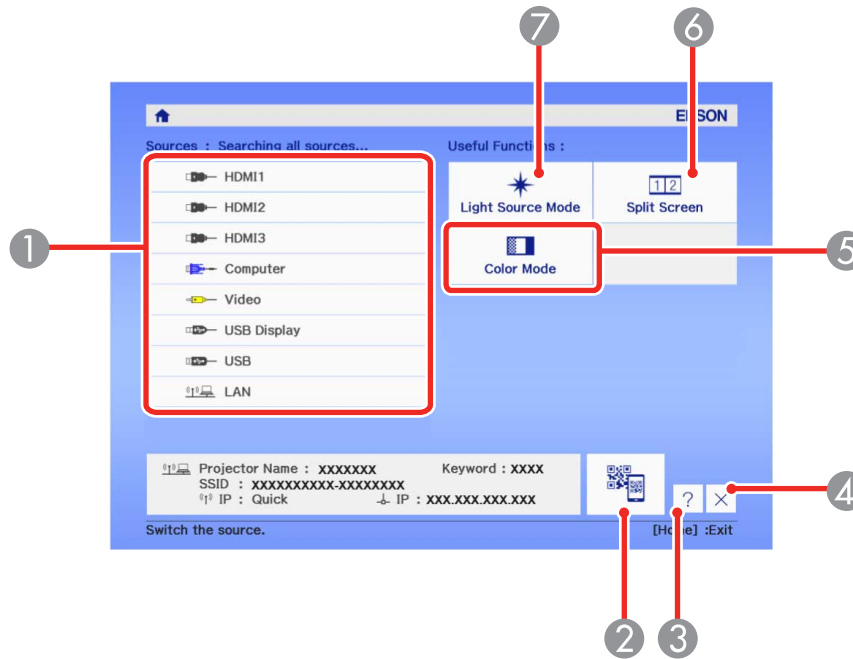

- 1 Selects the source you want to project
- 2 Displays a QR code for device connection
- 3 Displays the on-screen help
- 4 Hides the Home screen
- 5 Displays the settings assigned to Home screen in the projector's Extended menu
- 6 Projects two images from different image sources simultaneously by splitting the projected screen
- 7 Displays the brightness for the light source

**Note:** You can modify the customizable menu options using the **Custom Setting L1** through **Custom Setting R3** settings in the Extended menu.

3. Press the **Home** button or press the  icon to hide the Home screen.

**Parent topic:** [Turning On the Projector](#)

## Turning Off the Projector

Before turning off the projector, shut down any computer connected to it so you can see the computer display during shutdown.

**Note:** Turn off this product when not in use to prolong the life of the projector. Laser life will vary depending upon mode selected, environmental conditions, and usage. Brightness decreases over time.

1. Press the power button on the projector or remote control.

The projector displays a shutdown confirmation screen.



2. Press the power button again. (To leave it on, press any other button.)

The projector beeps twice, the laser turns off, and the Status light turns off.

**Note:** With Epson's Instant Off technology, there is no cool-down period so you can pack up the projector for transport right away (if necessary).

**Caution:** Do not turn the projector on immediately after turning it off. Turning the projector on and off frequently may shorten the life of the laser.

3. To transport or store the projector, make sure the Status light is off, then unplug the power cord.

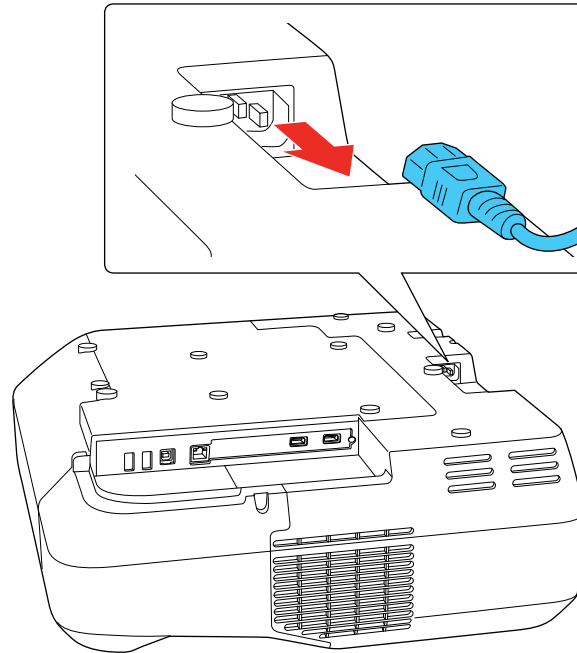

**Caution:** To avoid damaging the projector or laser, never unplug the power cord when the Status light is on or flashing.

**Parent topic:** [Using Basic Projector Features](#)

**Related references**

[Projector Setup Settings - Extended Menu](#)

## Selecting the Language for the Projector Menus

If you want to view the projector's menus and messages in another language, you can change the Language setting.

1. Turn on the projector.
2. Press the **Menu** button.

3. Select the **Extended** menu and press **Enter**.

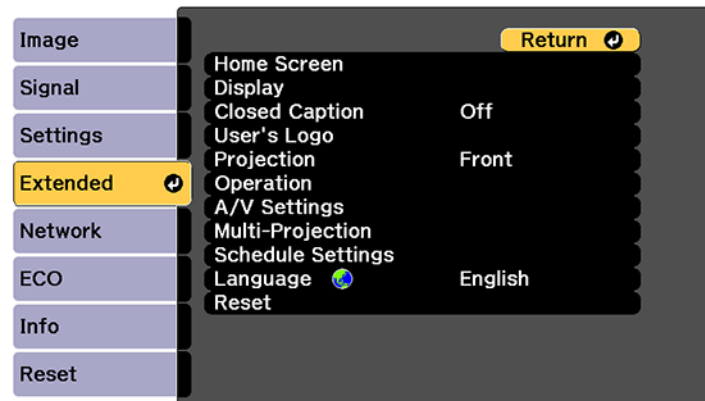

4. Select the **Language** setting and press **Enter**.
5. Select the language you want to use and press **Enter**.
6. Press **Menu** or **Esc** to exit the menus.

Parent topic: [Using Basic Projector Features](#)

## Setting the Date and Time

You can set the date and time for the projector.

1. Press the **Menu** button.
2. Select the **Extended** menu and press **Enter**.
3. Select the **Operation** setting and press **Enter**.
4. Select the **Date & Time** setting and press **Enter**.

You see a screen like this:

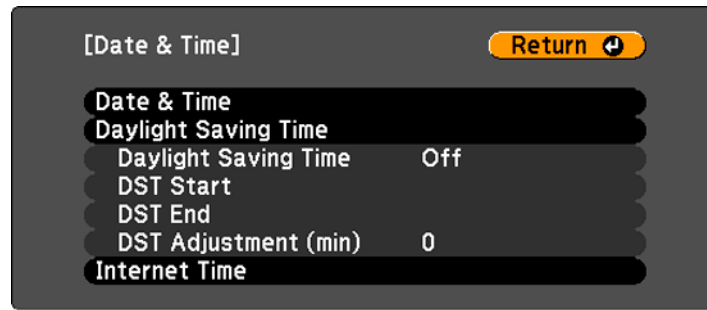

5. Select the **Date & Time** setting and press **Enter**.
6. Select your date and time settings. Then select **Set** and press **Enter** to confirm your changes.
7. When you are finished, press the **Menu** button to exit.

**Parent topic:** [Using Basic Projector Features](#)

## Image Shape

You can project an evenly rectangular image by placing the projector directly in front of the center of the screen and keeping it level. If you place the projector at an angle to the screen, or tilted up or down, or off to the side, you may need to correct the image shape for the best display quality.

[Correcting Image Shape with the Keystone Buttons](#)

[Correcting Image Shape with Quick Corner](#)

[Correcting Image Shape with Arc Correction](#)

**Parent topic:** [Using Basic Projector Features](#)

## Correcting Image Shape with the Keystone Buttons

You can use the projector's keystone correction buttons to correct the shape of an image that is unevenly rectangular on the sides.

**Note:** You can use the keystone buttons to correct the image up to  $\pm 3^\circ$  horizontally or vertically. If the projector is mounted on the wall, use the adjustment dials on the wall mount to correct the screen image before using any other digital correction methods.

1. Turn on the projector and display an image.

**Note:** You can display a pattern to aid in adjusting the projected image using the Settings menu.

2. Press one of these keystone buttons on the control panel to display the Keystone adjustment screen.

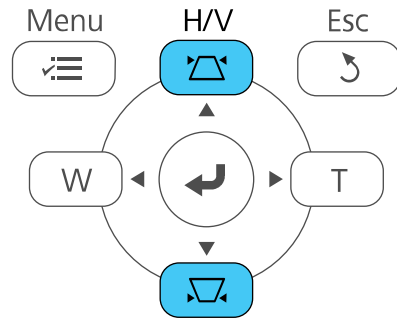

3. Press a keystone button on the projector's control panel to adjust the image shape.

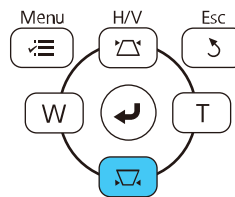
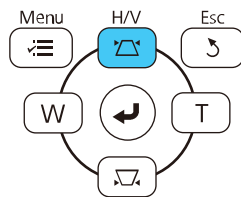
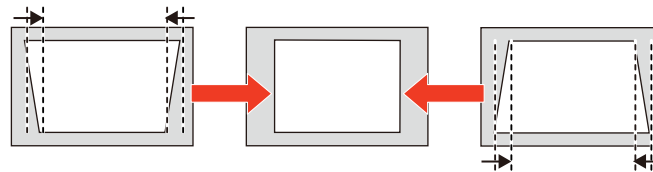
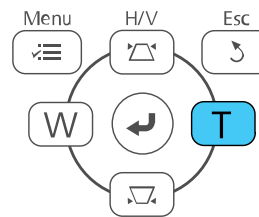
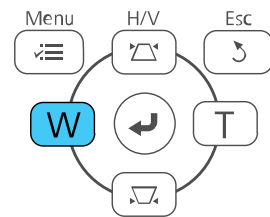
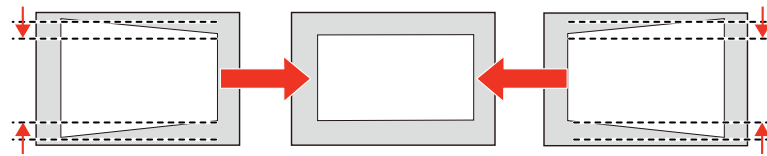

**Note:** The horizontal keystone adjustment buttons are labeled **W** and **T**.

After correction, your image is slightly smaller.

**Note:** If the projector is installed out of reach, you can also correct the image shape with the remote control using the **H/V-Keystone** settings in the projector menus.

**Parent topic:** [Image Shape](#)



## Related references

[Projector Feature Settings - Settings Menu](#)

## Correcting Image Shape with Quick Corner

You can use the projector's Quick Corner setting to correct the shape and size of an image that is unevenly rectangular on all sides.

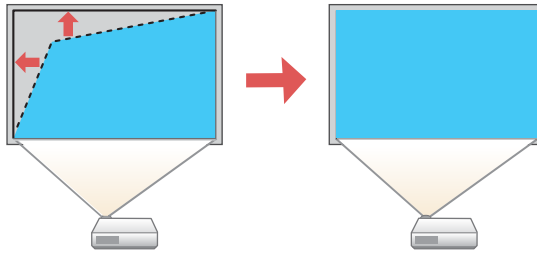

**Note:** If the projector is mounted on the wall, use the adjustment dials on the wall mount to correct the screen image before using any other digital correction methods.

1. Turn on the projector and display an image.

**Note:** You can display a pattern to aid in adjusting the projected image using the Settings menu.

2. Press the **Menu** button.

3. Select the **Settings** menu and press **Enter**.

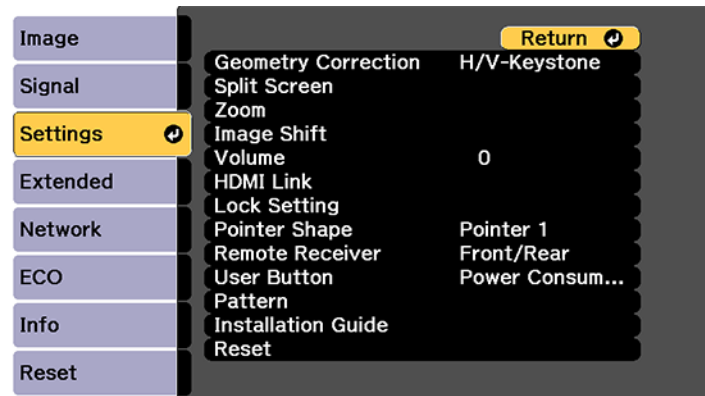

4. Select the **Geometry Correction** setting and press **Enter**.
5. Select the **Quick Corner** setting and press **Enter**. Then press **Enter** again.

You see the Quick Corner adjustment screen:

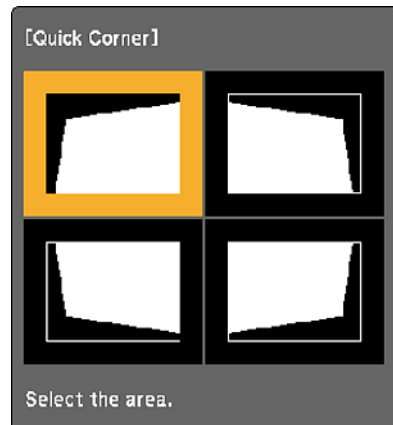

**Note:** To reset your adjustments, press and hold the **Esc** button for at least 2 seconds to display a reset screen. Then select **Yes**.

6. Use the arrow buttons on the projector or the remote control to select the corner of the image you want to adjust. Then press **Enter**.
7. Press the arrow buttons to adjust the image shape as necessary. Press **Enter** to return to the area selection screen.
8. When you are finished, press **Esc**.

**Parent topic:** [Image Shape](#)

**Related references**

[Projector Feature Settings - Settings Menu](#)

## Correcting Image Shape with Arc Correction

You can use the projector's Arc Correction setting to adjust the curve or arc of the sides of your image.

**Note:** If the projector is mounted on the wall, use the adjustment dials on the wall mount to correct the screen image before using any other digital correction methods.

1. Turn on the projector and display an image.

**Note:** You can display a pattern to aid in adjusting the projected image using the Settings menu.

2. Press the **Menu** button.
3. Select the **Settings** menu and press **Enter**.

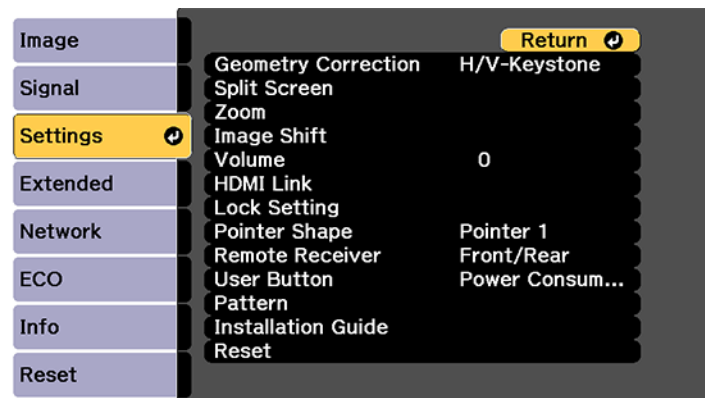

4. Select the **Geometry Correction** setting and press **Enter**.
5. Select the **Arc Correction** setting and press **Enter**. Then press **Enter** again.

You see the Arc Correction adjustment screen:

**Note:** To reset your adjustments, press the **Esc** button for at least 2 seconds to display a reset screen, and select **Yes**.

6. Use the arrow buttons on the projector or the remote control to select the corner or side of the image you want to adjust. Then press **Enter**.
7. Press the arrow buttons to adjust the image shape as necessary.
8. When you are finished, press **Esc**.
9. To save your adjusted image position, select **Save Memory** and select an entry. You can save up to three image positions.

**Parent topic:** [Image Shape](#)

**Related references**

[Projector Feature Settings - Settings Menu](#)

## Adjusting the Image Height

If you are projecting from a table or other flat surface, and the image is too high or low, you can adjust the image height using the projector's adjustable feet.

1. Attach the projector feet.
2. Turn on the projector and display an image.

3. To adjust the image height, rotate the front and rear feet to extend or retract them.

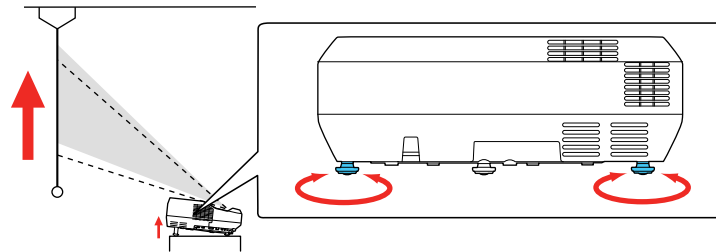
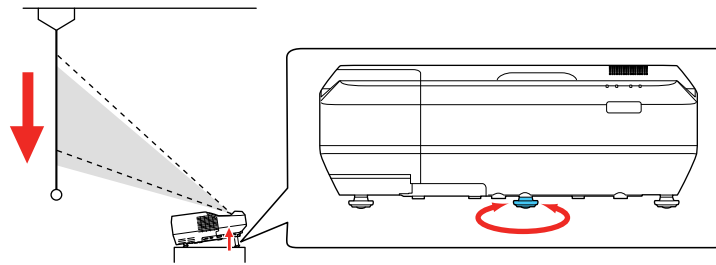

4. If the image is tilted, rotate the rear feet to adjust their height.

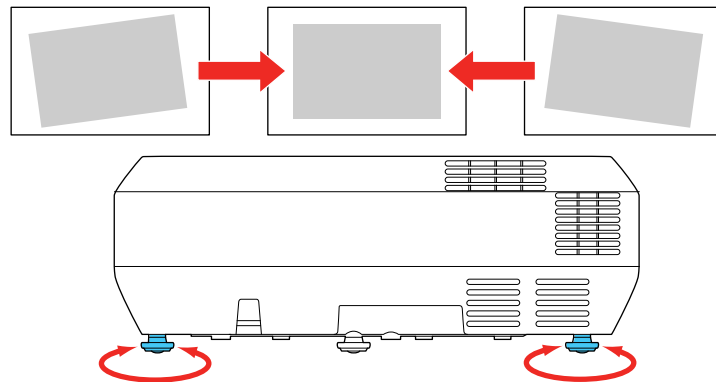

If the projected image is unevenly rectangular, you need to adjust the image shape.

**Parent topic:** [Using Basic Projector Features](#)

**Related references**

[Product Box Contents](#)

## Resizing the Image with the Wide and Tele Buttons

You can resize the image using the Wide and Tele buttons.

1. Turn on the projector and display an image.
2. To enlarge the image size, press the **W** (Wide) button on the projector's control panel.
3. To reduce the image size, press the **T** (Tele) button.

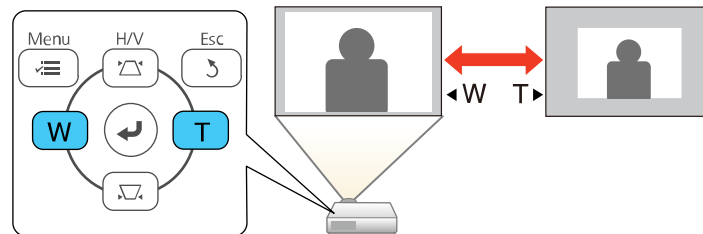

After you adjust the image size, the Image Shift screen is displayed automatically for adjusting the image position.

**Note:** If the projector is installed out of reach, you can also adjust the image size with the remote control using the **Zoom** setting in the projector menus.

**Parent topic:** [Using Basic Projector Features](#)

**Related references**

[Projector Feature Settings - Settings Menu](#)

## Adjusting the Image Position

You can use the Image Shift feature to adjust the image position without moving the projector.

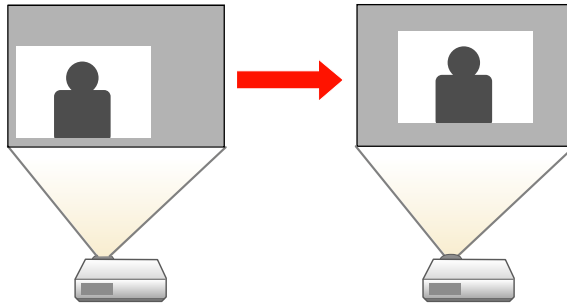

**Note:** This feature is not available if the **Zoom** option is set to the widest setting.

1. Turn on the projector and display an image.
2. Adjust the image size using the **W** (Wide) and **T** (Tele) buttons.  
After you adjust the image size, the Image Shift screen is displayed automatically.

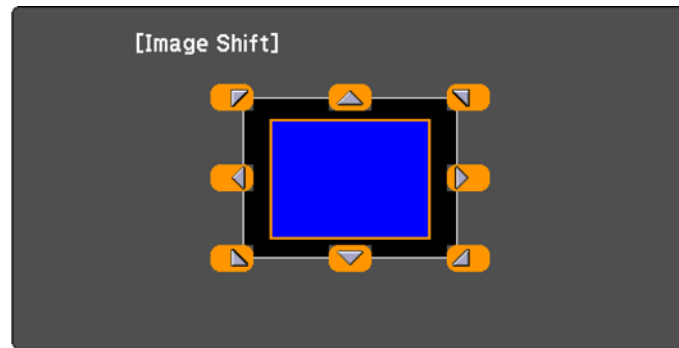

3. Use the arrow buttons on the projector or remote control to adjust the image position.

**Note:** You can also use the Settings menu to adjust the **Image Shift** setting.

**Parent topic:** [Using Basic Projector Features](#)

## Related references

[Projector Feature Settings - Settings Menu](#)

## Focusing the Image

1. Turn on the projector and display an image.

**Note:** You can display a pattern to aid in adjusting the projected image using the Settings menu.

2. Slide the air filter cover latch and open the air filter cover.

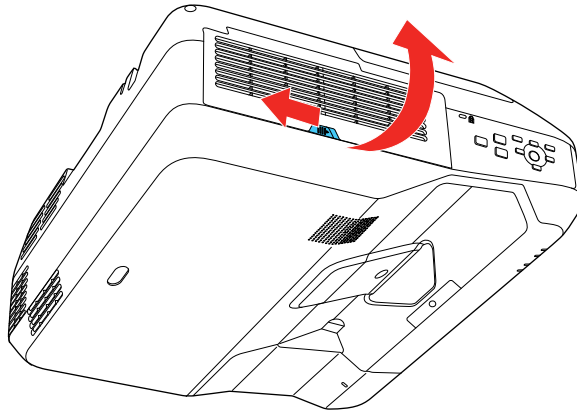



3. Raise or lower the focus lever to sharpen the image.

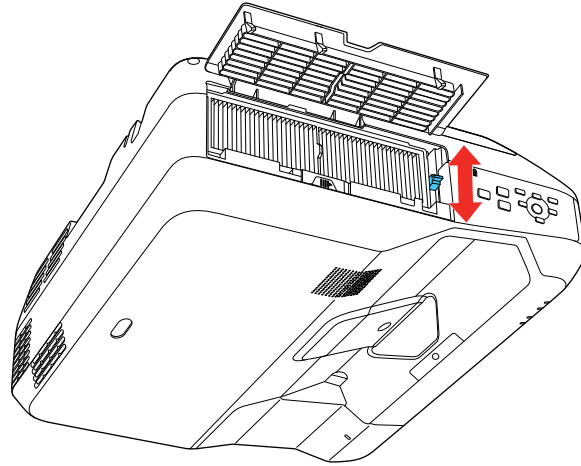

**Parent topic:** [Using Basic Projector Features](#)

**Related references**

[Projector Feature Settings - Settings Menu](#)

## Remote Control Operation

The remote control lets you control the projector from almost anywhere in the room, up to 19.7 feet (6 m) away. You can point it at the screen or board, or the front or back of the projector.

Make sure that you aim the remote control at the projector's receivers within the angles listed here.

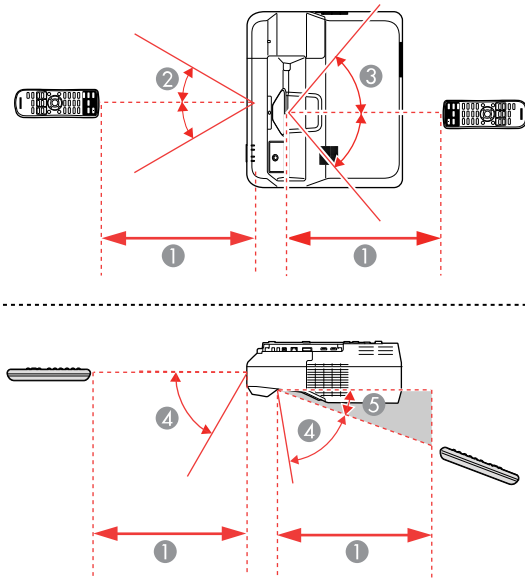

- 1 19.7 feet (6 m)
- 2  $\pm 30^\circ$
- 3  $\pm 55^\circ$
- 4  $60^\circ$
- 5  $15^\circ$

**Note:** Avoid using the remote control in conditions with bright fluorescent lights or in direct sunlight, or the projector may not respond to commands. If you will not use the remote control for a long time, remove the batteries.

[Using the Remote Control as a Wireless Mouse](#)

[Using the Remote Control as a Pointer](#)

**Parent topic:** [Using Basic Projector Features](#)

## Using the Remote Control as a Wireless Mouse

You can use the projector's remote control as a wireless mouse so you can control projection at a distance from the computer. The computer must be running Windows Vista or later, OS X 10.7 or later, macOS 10.12.x, or macOS 10.13.x.



1. Connect the projector to a computer using the projector's **USB-B**, **Computer**, or **HDMI** port to display video.

**Note:** You cannot use the wireless mouse feature with an MHL connection.

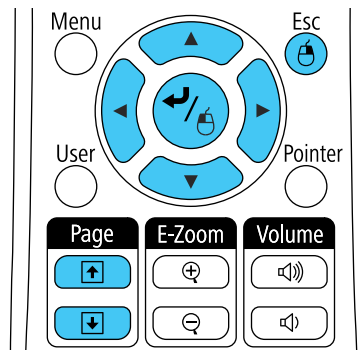
2. If you connected your computer to a port other than the projector's **USB-B** port, also connect a USB cable to the projector's **USB-B** port and to a USB port on your computer (for wireless mouse support).
3. Start your presentation.
4. Use the following buttons on the remote control to control your presentation:
  - To move through slides or pages, press the up or down **Page** buttons.



- To move the cursor on the screen, use the arrow buttons.
- To left-click, press the  button once (press it twice to double-click).
- To right-click, press the **Esc** button.

- To drag-and-drop, hold the  button as you move the cursor with the arrow buttons, then release the  button at the destination.

**Note:** If the mouse button settings are set to reverse on the computer, the remote control buttons will also be reversed.

**Parent topic:** [Remote Control Operation](#)

**Related references**

[Projector Setup Settings - Extended Menu](#)

## Using the Remote Control as a Pointer

You can use the projector's remote control as a pointer to help you call out important information on the screen. The default pointer shape is an arrow, but you can select an alternative shape using the Settings menu.

1. Press the **Pointer** button on the remote control.

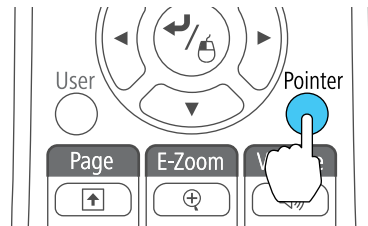

2. Use the arrow buttons on the remote control to move the pointer on the screen.

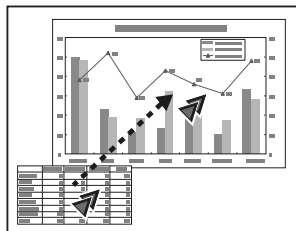

3. Press **Esc** to clear the pointer from the screen.

Parent topic: [Remote Control Operation](#)

### Related references

[Projector Feature Settings - Settings Menu](#)

## Selecting an Image Source

If you connected multiple image sources to the projector, such as a computer and DVD player, you may want to switch from one image source to the other.

1. Make sure the connected image source you want to use is turned on.
2. For video image sources, insert a DVD or other video media and press its play button, if necessary.
3. Do one of the following:
  - Press the **Source Search** button on the projector or remote control until you see the image from the source you want.

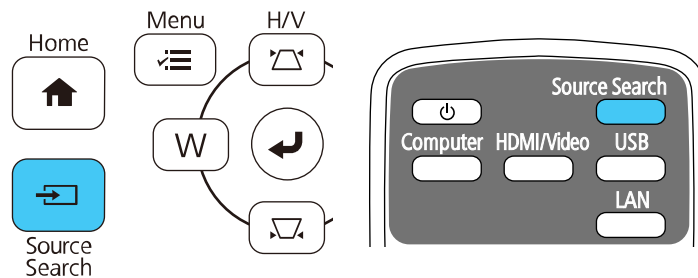

- Press the button for the source you want on the remote control. If there is more than one port for that source, press the button again to cycle through the sources.

- Press the **Home** button on the remote control and select your image source.

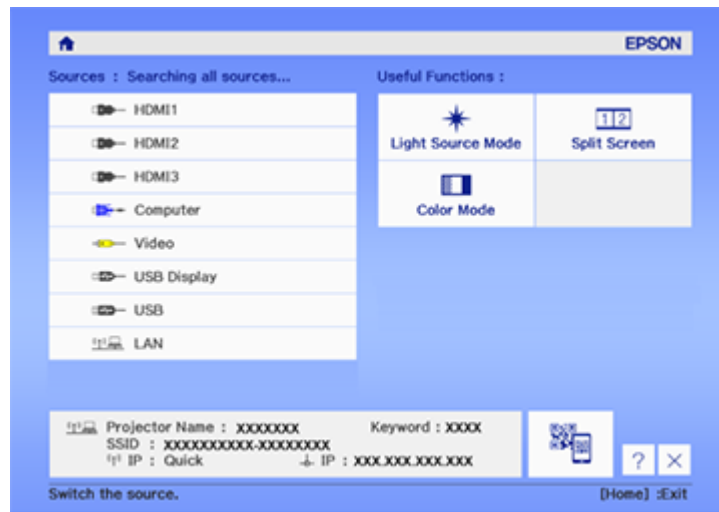

**Parent topic:** [Using Basic Projector Features](#)

**Related references**

[Projector Setup Settings - Extended Menu](#)

**Related tasks**

[Using the Home Screen](#)

## Projection Modes

Depending on how you positioned the projector, you may need to change the projection mode so your images project correctly.

- **Front** lets you project from a table in front of the screen.
- **Front/Upside Down** flips the image over top-to-bottom to project upside-down from a wall or ceiling mount.
- **Rear** flips the image horizontally to project from behind a translucent screen.
- **Rear/Upside Down** flips the image over top-to-bottom and horizontally to project from the wall or ceiling and behind a translucent screen.

You can change the projection mode using the remote control or by changing the **Projection** setting in the **Extended** menu.

[Changing the Projection Mode Using the Remote Control](#)

[Changing the Projection Mode Using the Menus](#)

**Parent topic:** [Using Basic Projector Features](#)

## Changing the Projection Mode Using the Remote Control

You can change the projection mode to flip the image over top-to-bottom.

1. Turn on the projector and display an image.
2. Hold down the **A/V Mute** button on the remote control for 5 to 10 seconds.

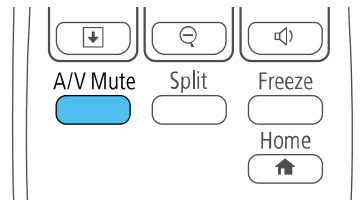

The image disappears briefly and reappears flipped top-to-bottom.

3. To change projection back to the original mode, hold down the **A/V Mute** button for 5 to 10 seconds again.

**Parent topic:** [Projection Modes](#)

## Changing the Projection Mode Using the Menus

You can change the projection mode to flip the image over top-to-bottom and/or left-to-right using the projector menus.

1. Turn on the projector and display an image.
2. Press the **Menu** button.

3. Select the **Extended** menu and press **Enter**.

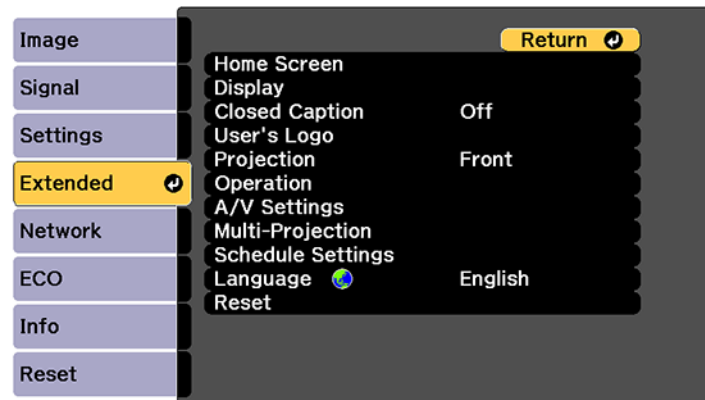

4. Select the **Projection** setting and press **Enter**.
5. Select a projection mode and press **Enter**.
6. Press **Menu** or **Esc** to exit the menus.

Parent topic: [Projection Modes](#)

## Image Aspect Ratio

The projector can display images in different width-to-height ratios called aspect ratios. Normally the input signal from your video source determines the image's aspect ratio. However, for certain images you can change the aspect ratio to fit your screen by pressing a button on the remote control.

If you always want to use a particular aspect ratio for a certain video input source, you can select it using the projector's menus.

[Changing the Image Aspect Ratio](#)

[Available Image Aspect Ratios](#)

Parent topic: [Using Basic Projector Features](#)

## Changing the Image Aspect Ratio

You can change the aspect ratio of the displayed image to resize it.

1. Turn on the projector and switch to the image source you want to use.



2. Press the **Aspect** button on the remote control.

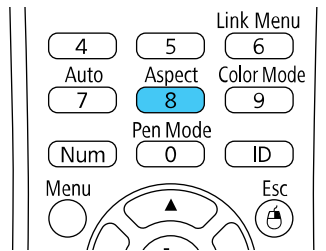

The shape and size of the displayed image changes, and the name of the aspect ratio appears briefly on the screen.

3. To cycle through the available aspect ratios for your input signal, press the **Aspect** button repeatedly.

**Note:** To remove black bars when projecting from a computer, set the **Resolution** setting to **Wide** or **Normal** in the Signal menu, depending on your computer's resolution.

**Parent topic:** [Image Aspect Ratio](#)

**Related references**

[Input Signal Settings - Signal Menu](#)

## Available Image Aspect Ratios

You can select the following image aspect ratios, depending on the input signal from your image source.

**Note:** Black bands and cropped images may project in certain aspect ratios, depending on the aspect ratio and resolution of your input signal.

Aspect ratio setting	Description
<b>Auto</b>	Automatically sets the aspect ratio according to the input signal and the <b>Resolution</b> setting.
<b>Normal</b>	Displays images using the full projection area and maintains the aspect ratio of the image.
<b>16:9</b>	Converts the aspect ratio of the image to 16:9.

Aspect ratio setting	Description
<b>Full</b>	Displays images using the full width of the projection area, but does not maintain the aspect ratio.
<b>Zoom</b>	Displays images using the full width of the projection area and maintains the aspect ratio of the image.
<b>Native</b>	Displays images as is (aspect ratio and resolution are maintained).

**Note:** The **Auto** aspect ratio setting is available only for HDMI image sources.

**Parent topic:** [Image Aspect Ratio](#)

## Color Mode

The projector offers different Color Modes to provide optimum brightness, contrast, and color for a variety of viewing environments and image types. You can select a mode designed to match your image and environment, or experiment with the available modes.

If you always want to use a particular color mode for a certain video input source, you can select it using the projector menus.

[Changing the Color Mode](#)

[Available Color Modes](#)

[Turning On Automatic Luminance Adjustment](#)

**Parent topic:** [Using Basic Projector Features](#)

## Changing the Color Mode

You can change the projector's Color Mode using the remote control to optimize the image for your viewing environment.

1. Turn on the projector and switch to the image source you want to use.
2. If you are projecting from a DVD player or other video source, insert a disc or other video media and press the play button, if necessary.

3. Press the **Color Mode** button on the remote control to change the Color Mode.

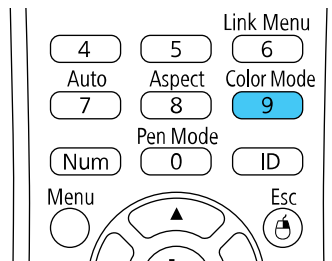

The image appearance changes and the name of the Color Mode appears briefly on the screen.

4. To cycle through all the available Color Modes for your input signal, press the **Color Mode** button repeatedly.

Parent topic: [Color Mode](#)

## Available Color Modes

You can set the projector to use these Color Modes, depending on the input source you are using:

Color Mode	Description
<b>Dynamic</b>	Best for video games in a bright room
<b>Presentation</b>	Best for color presentations in a bright room
<b>Cinema</b>	Best for movies projected in a dark room with natural tone images
<b>sRGB</b>	Best for standard sRGB computer displays
<b>DICOM SIM</b>	Best for projecting X-rays and other medical images (shows clear shadows)

**Note:** The **DICOM SIM** color mode is for reference purposes only and should not be used to make medical diagnoses.

Parent topic: [Color Mode](#)

## Turning On Automatic Luminance Adjustment

In the **Dynamic** and **Cinema** color modes, you can turn on the **Dynamic Contrast** setting to automatically optimize the image luminance. This improves the image contrast based on the brightness of the content you project.

1. Turn on the projector and switch to the image source you want to use.
2. Press the **Menu** button.
3. Select the **Image** menu and press **Enter**.

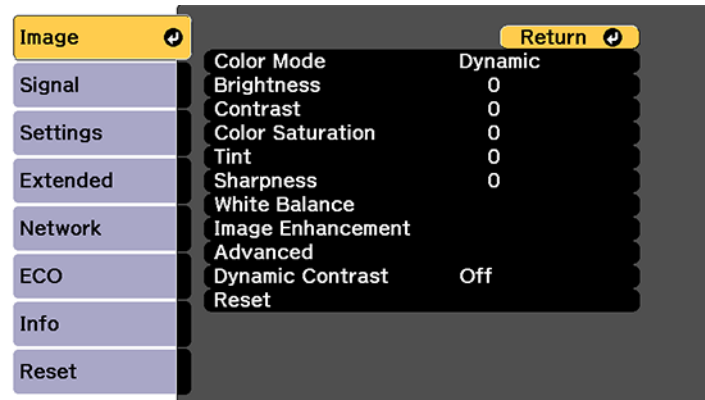

4. Select the **Dynamic Contrast** setting, choose one of the following options, and press **Enter**:
  - **High Speed** to adjust brightness as soon as the scene changes.
  - **Normal** to adjust brightness at the standard speed.
5. Press **Menu** or **Esc** to exit the menus.

**Parent topic:** [Color Mode](#)

### Related references

[Projector Setup Settings - Extended Menu](#)

## Controlling the Volume with the Volume Buttons

You can use the **Volume** buttons on the remote control or projector to adjust the volume as you project a presentation with audio. The volume buttons control the projector's internal speaker system or any external speakers you connected to the projector.

You must adjust the volume separately for each connected input source.

1. Turn on the projector and start a presentation that includes audio.
2. To lower or raise the volume, press the **Volume** buttons on the remote control.

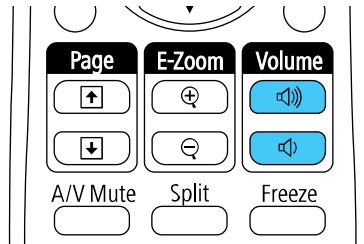

A volume gauge appears on the screen.

3. To set the volume to a specific level for an input source, use the projector menus.

**Parent topic:** [Using Basic Projector Features](#)

## Projecting a PC Free Presentation

You can use your projector's PC Free feature whenever you connect a USB device that contains compatible files. This lets you quickly and easily display the contents of the files and control their display using the projector's remote control.

[Supported PC Free File Types](#)

[Starting a PC Free Slide Show](#)

[Starting a PC Free Movie Presentation](#)

[PC Free Display Options](#)

**Parent topic:** [Using Basic Projector Features](#)

## Supported PC Free File Types

You can project these types of files using the projector's PC Free feature.

**Note:** For best results, place your files on media that is formatted in FAT16/32. If you have trouble projecting from media formatted for non-Windows file systems, try formatting the media for Windows instead. You may not be able to use the security features on certain USB storage devices with PC Free features. When connecting a USB-compatible hard drive, connect the AC adapter supplied with the drive. PC Free may not work with USB device security features.

File type and extension	Details
Image (.jpg)	Make sure the file is not: <ul style="list-style-type: none"> <li>• CMYK format</li> <li>• Progressive format</li> <li>• Highly compressed</li> <li>• Above 8192 × 8192 resolution</li> </ul>
Image (.bmp)	Make sure the file resolution is not above 1280 × 800
Image (.gif )	Make sure the file is not: <ul style="list-style-type: none"> <li>• Above 1280 × 800 resolution</li> <li>• Animated</li> </ul>
Image (.png)	Make sure the file resolution is not above 1920 × 1200
Motion JPEG movie (.avi)	Supports only AVI 1.0 Make sure the file is not: <ul style="list-style-type: none"> <li>• Saved with an audio codec other than PCM or ADPCM</li> <li>• Above 1280 × 720 resolution</li> <li>• Larger than 2GB</li> </ul>

Parent topic: [Projecting a PC Free Presentation](#)

## Starting a PC Free Slide Show

After connecting a USB device or digital camera to the projector, you can switch to the USB input source and start your slide show.

**Note:** You can change the PC Free operation options or add special effects by highlighting **Option** at the bottom of the screen and pressing **Enter**.

1. Press the **Source Search** button on the projector or remote control.
2. Select the **USB1** source.

The PC Free screen appears.



**Note:** If the Select Drive screen appears, press the arrow buttons to select the drive and press **Enter**.

3. Do the following as necessary to locate your files:
  - If you need to display files inside a subfolder on your device, press the arrow buttons to highlight the folder and press the **Enter** button.
  - To move back up a folder level on your device, highlight **Back to Top** and press **Enter**.
  - To view additional files in a folder, highlight **Next page** or **Previous page** and press **Enter**. (You can also press the **Page** up or down buttons on the remote control.)
  - To display images from a different USB drive, select **Select Drive** at the top of the PC Free screen and press **Enter**.
4. Do one of the following:
  - To display an individual image, press the arrow buttons to highlight the image and press **Enter**. (Press the **Esc** button to return to the file list screen.)

- To display a slide show of all the images in a folder, press the arrow buttons to highlight the **Slideshow** option at the bottom of the screen and press **Enter**.

**Note:** If any file names are longer than 8 characters or include unsupported symbols, the file names may be shortened or changed only in the screen display.

5. While projecting, use the following commands to control the display as necessary:
  - To rotate a displayed image, press the up or down arrow button.
  - To move to the next or previous image, press the left or right arrow button.
6. To stop the display, follow the on-screen instructions or press the **Esc** button.
7. Turn off the USB device, if necessary, and then disconnect the device from the projector.

**Parent topic:** [Projecting a PC Free Presentation](#)

## Starting a PC Free Movie Presentation

After connecting a USB device or digital camera to the projector, you can switch to the USB input source and start your movie.

**Note:** You can change the PC Free operation options by highlighting **Option** at the bottom of the screen and pressing **Enter**.

1. Press the **Source Search** button on the projector or remote control.
2. Select the **USB1** source.



The PC Free screen appears.



**Note:** If the Select Drive screen appears, press the arrow buttons to select the drive and press **Enter**.

3. Do the following as necessary to locate your files:
  - If you need to display files inside a subfolder on your device, press the arrow buttons to highlight the folder and press the **Enter** button.
  - To move back up a folder level on your device, highlight **Back to Top** and press **Enter**.
  - To view additional files in a folder, highlight **Next page** or **Previous page** and press **Enter**. (You can also press the **Page** up or down buttons on the remote control.)
  - To display movie files from a different USB drive, select **Select Drive** at the top of the PC Free screen and press **Enter**.
4. To play back a movie, press the arrow buttons to highlight the file and press **Enter**.

**Note:** If any file names are longer than 8 characters or include unsupported symbols, the file names may be shortened or changed only in the screen display. If you want to play back all the movies in a folder in sequence, select the **Slideshow** option at the bottom of the screen.

5. To stop movie playback, press the **Esc** button, highlight **Exit**, and press **Enter**.
6. Turn off the USB device, if necessary, and then disconnect the device from the projector.

**Parent topic:** [Projecting a PC Free Presentation](#)

## PC Free Display Options

You can select these display options when using the projector's PC Free feature.

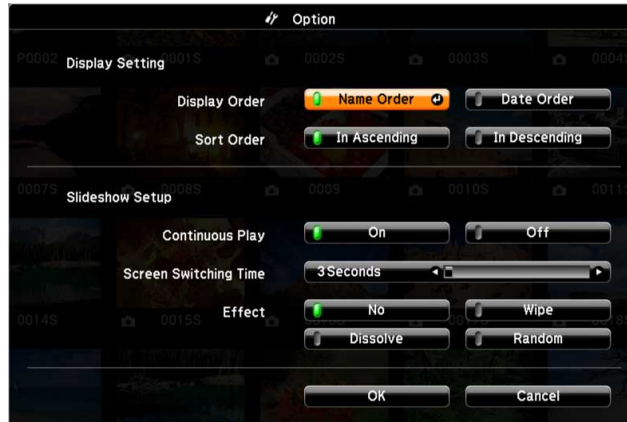

Setting	Options	Description
<b>Display Order</b>	<b>Name Order</b>	Displays files in name order
	<b>Date Order</b>	Displays files in date order
<b>Sort Order</b>	<b>In Ascending</b>	Sorts files in first-to-last order
	<b>In Descending</b>	Sorts files in last-to-first order
<b>Continuous Play</b>	<b>On</b>	Displays a slide show continuously
	<b>Off</b>	Displays a slide show one time through
<b>Screen Switching Time</b>	<b>No</b>	Does not display the next file automatically
	1 Second to 60 Seconds	Displays files for the selected time and switches to the next file automatically; high resolution images may switch at a slightly slower rate

<b>Setting</b>	<b>Options</b>	<b>Description</b>
<b>Effect</b>	<b>Wipe</b>	Transitions between images with a wipe effect
	<b>Dissolve</b>	Transitions between images with a dissolve effect
	<b>Random</b>	Transitions between images using a random variety of effects

**Parent topic:** [Projecting a PC Free Presentation](#)

---

# Adjusting Projector Features

Follow the instructions in these sections to use your projector's feature adjustments.

[Projecting Two Images Simultaneously](#)

[Using Multiple Projectors](#)

[Shutting Off the Picture and Sound Temporarily](#)

[Stopping Video Action Temporarily](#)

[Zooming Into and Out of Images](#)

[Scheduling Projector Events](#)

[Projector Security Features](#)

[Creating a User Pattern to Display](#)

[Copying Menu Settings Between Projectors](#)

## Projecting Two Images Simultaneously

You can use the split screen feature to simultaneously project two images from different image sources next to each other. You can control the split screen feature using the remote control or the projector menus.

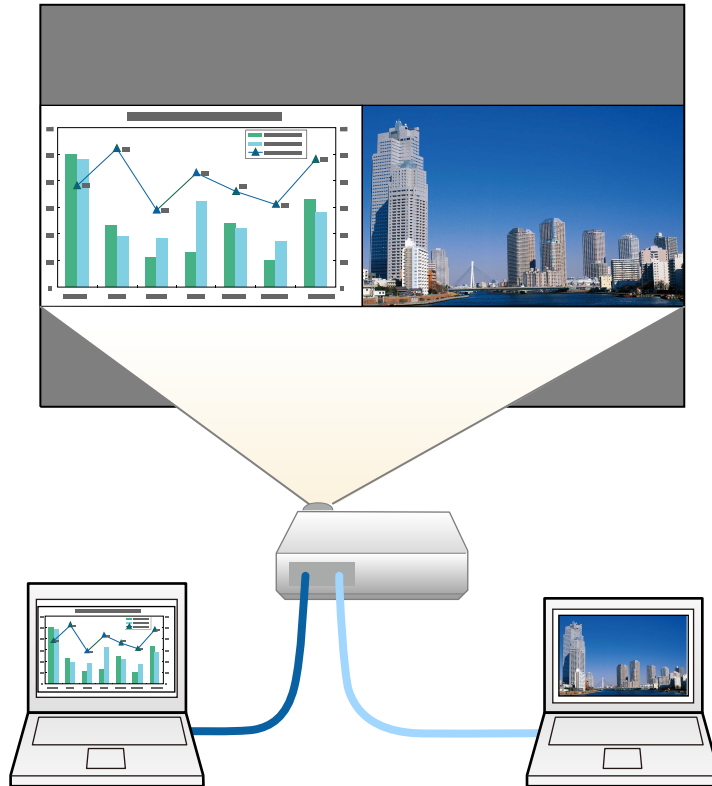

**Note:** While you use the split screen feature, other projector features may not be available and some settings may be automatically applied to both images.

**Note:** You cannot use split screen with certain input source combinations.

1. Press the **Split** button on the remote control.

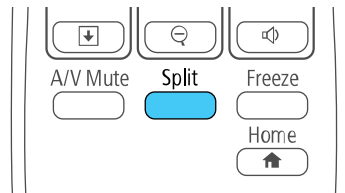

The currently selected input source moves to the left side of the screen.

2. Press the **Menu** button.

You see this screen:

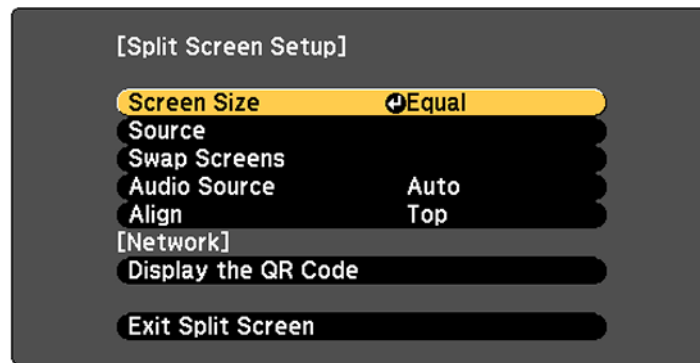

3. To select an input source for the other image, select the **Source** setting, press **Enter**, select the input source, select **Execute**, and press **Enter**. (You can also change image sources, if necessary.)
4. To switch the images, select the **Swap Screens** setting and press **Enter**.
5. To change the image sizes, select the **Screen Size** setting, press **Enter**, select a sizing option, press **Enter**, and press **Menu** to exit.

**Note:** Depending on the video input signals, the images may not appear at the same size even if you choose the **Equal** setting.

6. To choose the audio you want to hear, select the **Audio Source** setting, press **Enter**, select an audio option, press **Enter**, and press **Menu** to exit.
7. To align the projected images, select the **Align** setting, press **Enter**, select the setting, press **Enter**, and press **Menu** to exit.
8. To exit the split screen feature, press the **Split** or **Esc** button.

[Input Sources for Split Screen Projection](#)

Parent topic: [Adjusting Projector Features](#)

## Input Sources for Split Screen Projection

You can choose from the input source combinations listed here for split screen projection.

Left Screen	Right Screen								
	HDMI1/ MHL	HDMI2	HDMI3	Computer	Video	USB Display	USB1	USB2	LAN
HDMI1/MHL	—	✓	✓	✓	✓	✓	✓	✓	✓
HDMI2	✓	—	✓	✓	✓	✓	✓	✓	✓
HDMI3	✓	✓	—	✓	✓	✓	✓	✓	✓
Computer	✓	✓	✓	—	—	✓	✓	✓	✓
Video	✓	✓	✓	—	—	✓	✓	✓	✓
USB Display	✓	✓	✓	✓	✓	—	—	—	—
USB1	✓	✓	✓	✓	✓	—	—	—	—
USB2	✓	✓	✓	✓	✓	—	—	—	—
LAN	✓	✓	✓	✓	✓	—	—	—	—

Parent topic: [Projecting Two Images Simultaneously](#)

Related concepts

[Projector Connections](#)

## Using Multiple Projectors

You can combine the projected images from two or more projectors to create one large image. Follow the instructions in these sections to set up and project from multiple projectors.

[Projector Identification System for Multiple Projector Control](#)  
[Adjusting Color Uniformity](#)  
[Adjusting the Projector's Brightness Level](#)  
[Matching the Image Colors](#)  
[Adjusting RGBCMY](#)

**Parent topic:** [Adjusting Projector Features](#)

## Projector Identification System for Multiple Projector Control

You can operate multiple projectors using one remote control for more elaborate presentations. To do this, you assign an identification number to each projector and to the remote control. Then you can operate all the projectors at once or individually.

[Setting the Projector ID](#)

[Setting the Remote Control ID](#)

**Parent topic:** [Using Multiple Projectors](#)

### Setting the Projector ID

If you want to control multiple projectors from a remote control, give each projector a unique ID.

1. Press the **Menu** button.
2. Select the **Extended** menu and press **Enter**.
3. Select the **Multi-Projection** setting and press **Enter**.
4. Select **Projector ID** and press **Enter**.

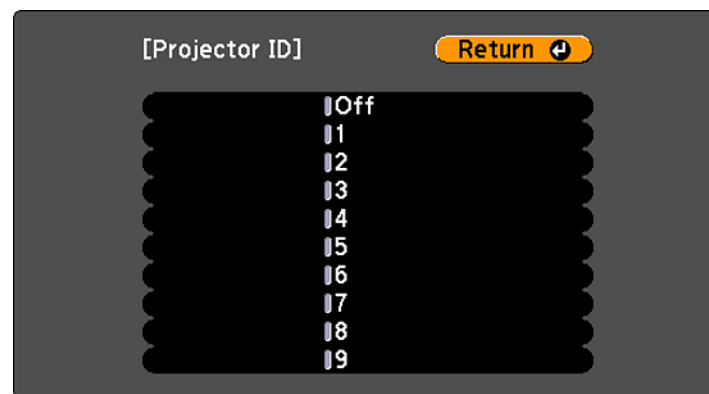



5. Press the arrow buttons on the remote control to select the identification number you want to use for the projector. Then press **Enter**.

Repeat these steps for all the other projectors you want to operate from one remote control.

**Note:** If you don't know the projector's ID, aim the remote control at the projector and press the **ID** button to temporarily display the projector's ID on the screen.

**Parent topic:** [Projector Identification System for Multiple Projector Control](#)

### Setting the Remote Control ID

The remote control's ID is set to zero by default so it can operate any compatible projector. If you want to set the remote control to operate only a particular projector, you need to set the remote control's ID to match the projector's ID.

**Note:** You must set the remote control ID to match the projector ID each time you turn on the projector you have set it to control.

1. Turn on the projector you want the remote control to operate with exclusively.
2. Make sure you know the projector's ID number as set in the Extended menu **Projector ID** setting.

**Note:** If you have forgotten the projector's ID, aim the remote control at the projector and press the **ID** button to temporarily display the projector's ID on the screen. If you turn off the **Projector ID** setting, the remote control will operate the projector regardless of the ID selected on the remote.

3. Aim the remote control at that projector.
4. Hold down the **ID** button on the remote control while you press the numeric button that matches the projector's ID. Then release the buttons.

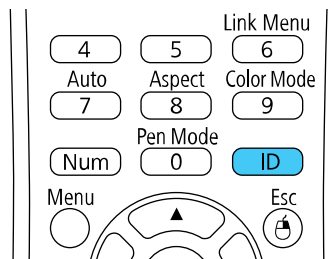

5. Press the **ID** button on the remote control to check if the ID-setting process worked.

You see a message displayed by the projector.

- If the remote control is listed as **On**, the remote control ID is set to operate only the listed projector.
- If the remote control is listed as **Off**, the remote control ID is not set properly. Repeat the steps above to set the ID to match the projector you want to control.

**Parent topic:** [Projector Identification System for Multiple Projector Control](#)

## Adjusting Color Uniformity

If the color tone is uneven on each screen, adjust the color tone balance in the Extended menu of each projector. (The color tone may not be uniform even after performing color uniformity.)

**Note:** If you cannot adjust color uniformity, make sure the **Color Mode** setting is not set to **Dynamic**. (The **Color Mode** for both projectors should be set to **Presentation**.)

1. Press the **Menu** button on the remote or control panel, select the **Extended** menu, and press **Enter**.

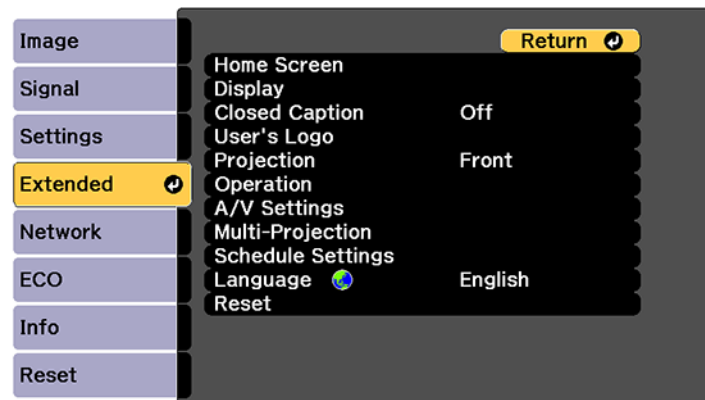

2. Select the **Multi-Projection** setting and press **Enter**.

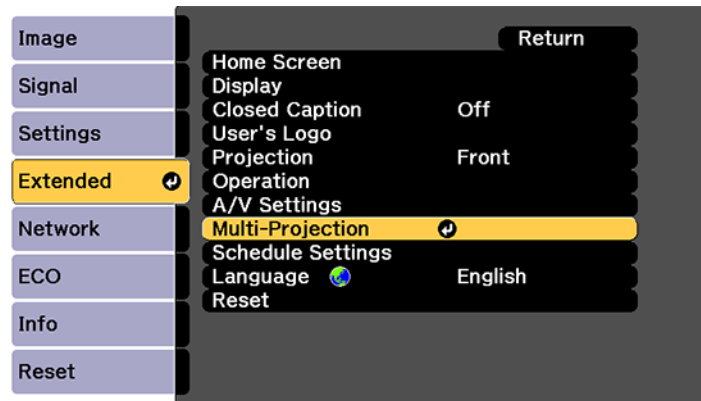

3. Select the **Color Uniformity** setting and press **Enter**.

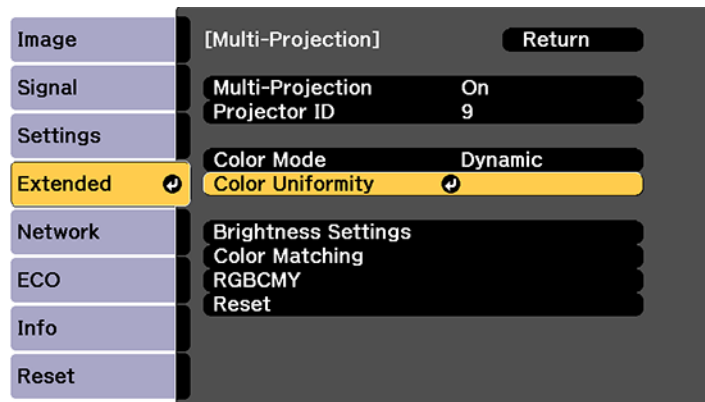

4. Select **On** as the **Color Uniformity** setting and press **Enter**, then press **Esc**.
5. Select **Adjustment Level** and press **Enter**.
6. Select an adjustment level and press **Esc**.
7. Select **Start Adjustments** and press **Enter**.

8. Select the area you want to adjust and press **Enter**.



9. Select **Red**, **Green**, or **Blue** and press the left arrow button to weaken the color tone or the right arrow button to strengthen the color tone.

**Note:** The adjustment screen changes each time you press **Enter**.

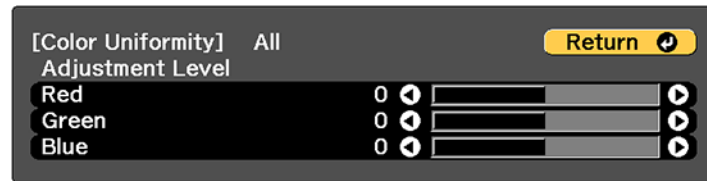

10. Press **Esc** to return to the area selection screen.
11. Repeat steps 8 through 10 for each area, then select **All** to adjust the entire screen.
12. Press **Esc** to exit the menus.

**Parent topic:** [Using Multiple Projectors](#)

## Adjusting the Projector's Brightness Level

When projecting with multiple projectors, you must adjust the brightness setting so that all projectors are equally bright. (Even after adjusting the brightness levels, the brightness of each projector may not match exactly.)

1. Turn on all the projectors and display the same image.

2. Press the **Menu** button.
3. Select the **ECO** menu and press **Enter**.
4. Select **Brightness Settings** and press **Enter**.
5. Select **Normal** for the **Light Source Mode** setting and press **Esc**.

**Note:** If you have set **Multi-Projection** to **On**, you cannot change the **Light Source Mode** setting.

6. Select the **Extended** menu and press **Enter**.

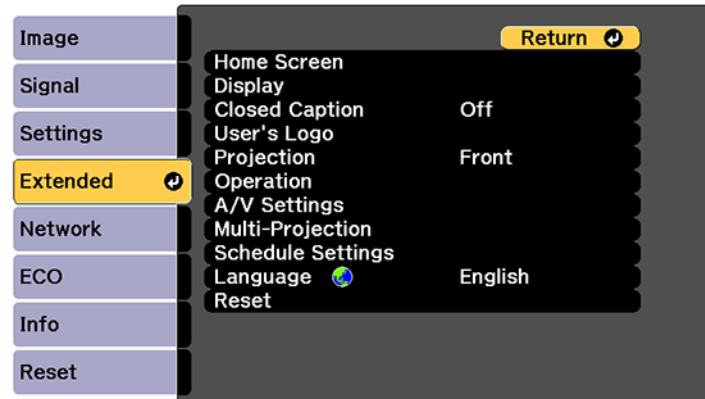

7. Select the **Multi-Projection** setting and press **Enter**.

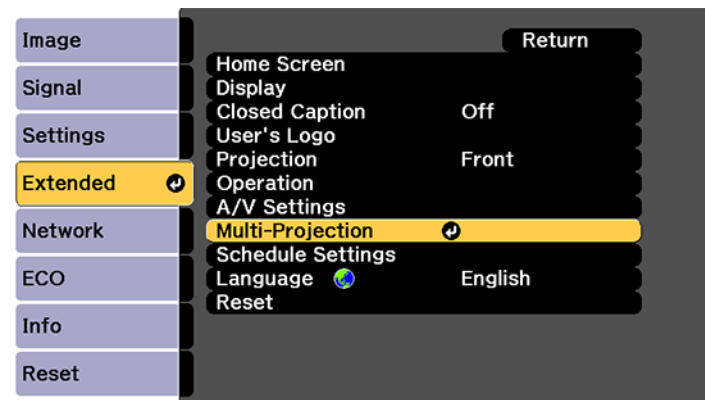

8. Select **On** and press **Esc**.
9. Select **Brightness Settings** and press **Enter**.

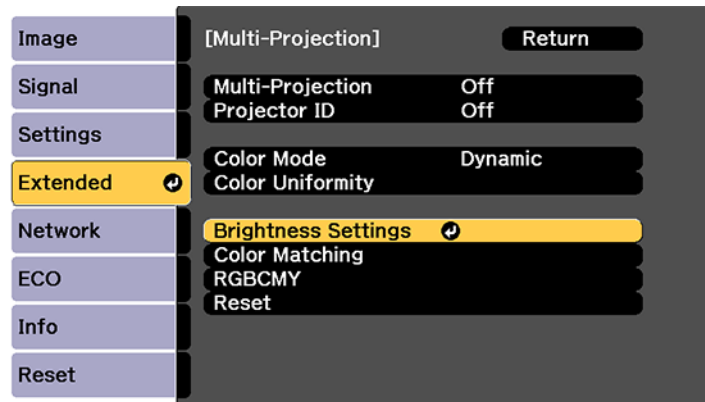

10. Select the **Brightness Level** setting and press **Enter**.
11. Use the left and right arrow buttons on the remote control to adjust the brightness level.
12. Press **Esc** to return to the previous screen.

**Parent topic:** [Using Multiple Projectors](#)

## Matching the Image Colors

You can match the display color of multiple projectors that will project next to one another.

1. Press the **Menu** button.

2. Select the **Extended** menu and press **Enter**.

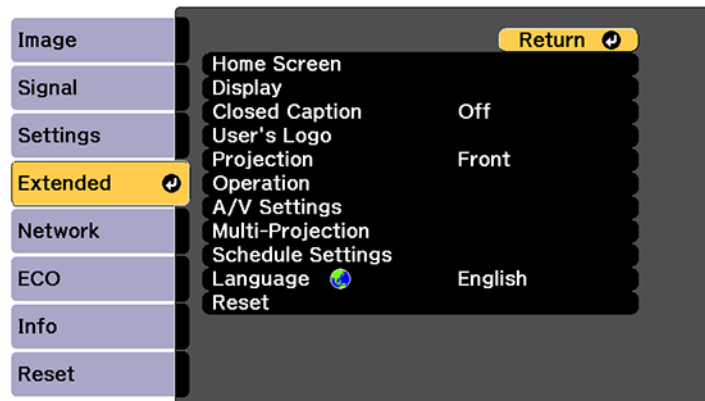

3. Select the **Multi-Projection** setting and press **Enter**.

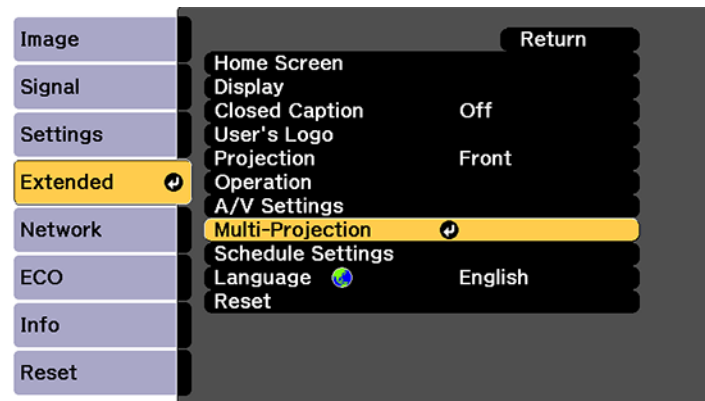

4. Select the **Color Matching** setting and press **Enter**.

You see this screen:



5. Press the left or right arrow buttons to select a value for the **Adjustment Level** setting.

**Note:** There are several adjustment levels and you can adjust each level individually.

6. Press the left or right arrow buttons to adjust the color tone for the **Red**, **Green**, and **Blue** settings.
7. Press the left or right arrow buttons to adjust the **Brightness** setting.
8. Repeat the previous three steps as necessary to adjust each adjustment level.

**Parent topic:** [Using Multiple Projectors](#)

## Adjusting RGBCMY

You can adjust the **Hue**, **Saturation**, and **Brightness** settings for R (red), G (green), B (blue), C (cyan), M (magenta), and Y (yellow) color components.

Turn on all the projectors and select the **RGBCMY** setting in each projector's Extended menu so that the color tone on the combined screen becomes entirely even.

1. Press the **Menu** button.



2. Select the **Extended** menu and press **Enter**.

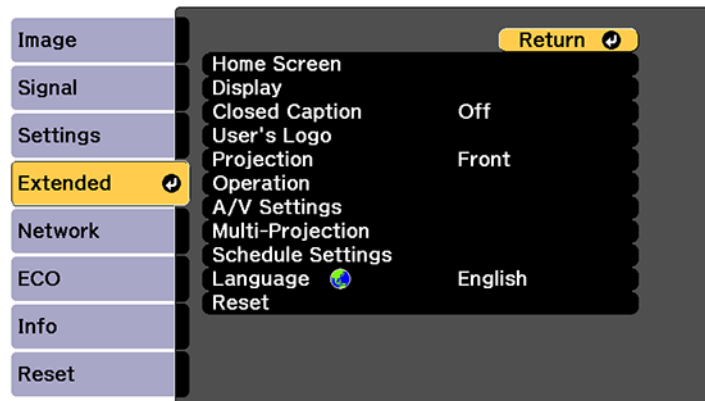

3. Select the **Multi-Projection** setting and press **Enter**.

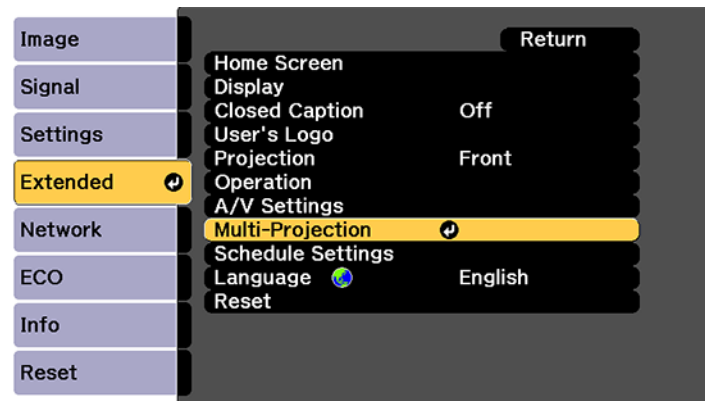

4. Select the **RGBCMY** setting and press **Enter**.

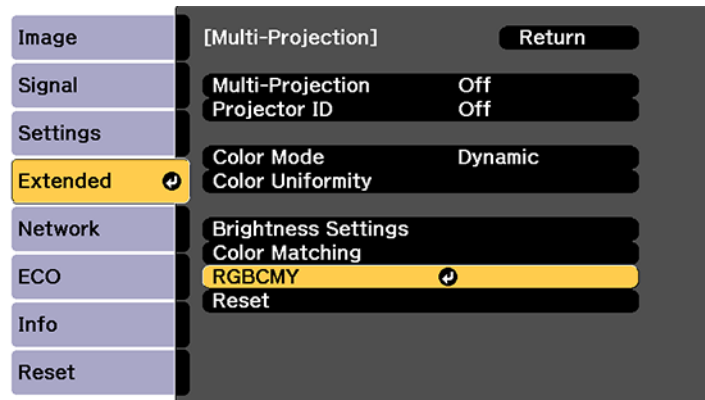

5. Select the color you want to adjust and press **Enter**.

You see this screen:

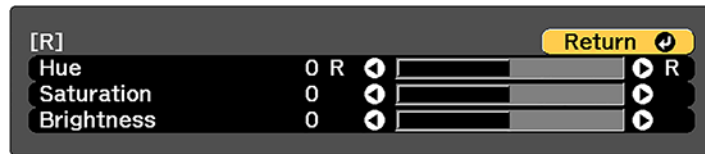

- To adjust the overall hue of the color, adjust the **Hue** setting.
  - To adjust the overall vividness of the color, adjust the **Saturation** setting.
  - To adjust the overall brightness of the color, adjust the **Brightness** setting.
6. Press the left or right arrow buttons to adjust the **Hue**, **Saturation**, and **Brightness** settings.
  7. Repeat the previous three steps as necessary to adjust each color.
  8. Press **Menu** or **Esc** to exit the menus.

**Parent topic:** [Using Multiple Projectors](#)

## Shutting Off the Picture and Sound Temporarily

You can temporarily turn off the projected picture and sound if you want to redirect your audience's attention during a presentation. Any sound or video action continues to run, however, so you cannot resume projection at the point that you stopped it.

If you want to display an image such as a company logo or picture when the presentation is stopped, you can set up this feature using the projector's menus.

1. Press the **A/V Mute** button on the remote control to temporarily stop projection and mute any sound.

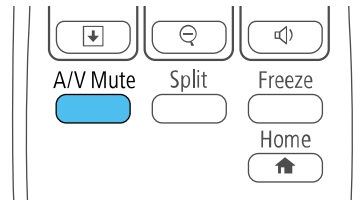

2. To turn the picture and sound back on, press **A/V Mute** again.

**Note:** The projector's power automatically turns off thirty minutes after A/V Mute is enabled. You can disable this feature in the projector's **Eco** menu.

**Parent topic:** [Adjusting Projector Features](#)

### Related tasks

[Saving a User's Logo Image to Display](#)

## Stopping Video Action Temporarily

You can temporarily stop the action in a video or computer presentation and keep the current image on the screen. Any sound or video action continues to run, however, so you cannot resume projection at the point that you stopped it.

1. Press the **Freeze** button on the remote control to stop the video action.

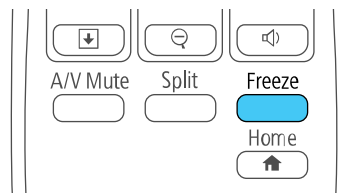

2. To restart the video action in progress, press **Freeze** again.

Parent topic: [Adjusting Projector Features](#)

## Zooming Into and Out of Images

You can draw attention to parts of a presentation by zooming into a portion of the image and enlarging it on the screen.

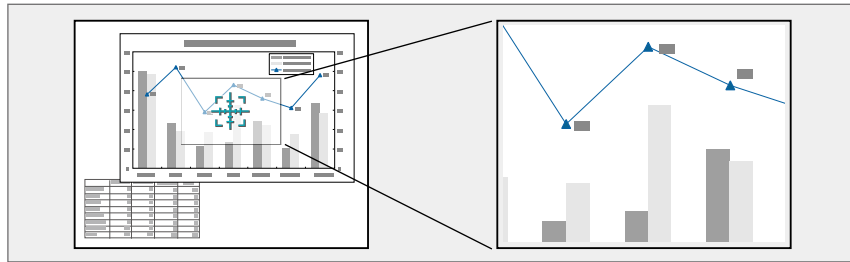

1. Press the **E-Zoom +** button on the remote control.

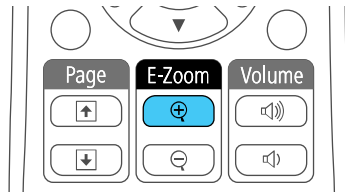

You see a crosshair on the screen indicating the center of the zoom area.

2. Use the following buttons on the remote control to adjust the zoomed image:
  - Use the arrow buttons to position the crosshair in the image area you want to zoom into.
  - Press the **E-Zoom +** button repeatedly to zoom into the image area, enlarging it as necessary. Press and hold the **E-Zoom +** button to zoom in more quickly.
  - To pan around the zoomed image area, use the arrow buttons.
  - To zoom out of the image, press the **E-Zoom –** button as necessary.
  - To return to the original image size, press **Esc**.

Parent topic: [Adjusting Projector Features](#)

## Scheduling Projector Events

You can save a projector command, such as turning the projector on or off or switching input sources, as an "event". You can schedule when you want the projector to automatically execute the command.

**Note:** The **Schedule Protection** setting in the Password Protection menu must be turned off to schedule an event.

[Saving a Scheduled Event](#)

[Viewing Scheduled Events](#)

[Editing a Scheduled Event](#)

**Parent topic:** [Adjusting Projector Features](#)

### Saving a Scheduled Event

You can select projector commands you want to perform and schedule them as an event.

1. Set the date and time in the **Date & Time** menu.
2. Press the **Menu** button.
3. Select the **Extended** menu and press **Enter**.
4. Select the **Schedule Settings** setting and press **Enter**.
5. Select the **Schedule** menu and press **Enter**.
6. Select **Add New** and press **Enter**.

You see a screen like this:

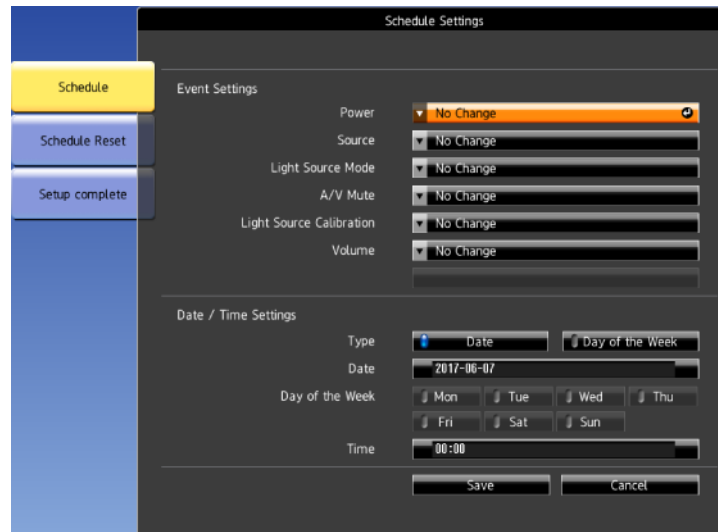

7. In the Event Settings section, select the events you want to have occur. (Select **No Change** for events that you do not want to occur.)
8. In the Date/Time Settings section, set the date and time for the scheduled events to occur.
9. When you are finished, select **Save** and press **Enter**.
10. To schedule more events, repeat the previous steps as necessary.
11. Select **Setup complete** and select **Yes** to save your changes.

**Parent topic:** [Scheduling Projector Events](#)

## Viewing Scheduled Events

You can view your scheduled events on the calendar displayed on the Schedule Settings screen.

1. Press the **Menu** button on the remote control or control panel.
2. Select the **Extended** menu and press **Enter**.
3. Select **Schedule Settings** and press **Enter**.

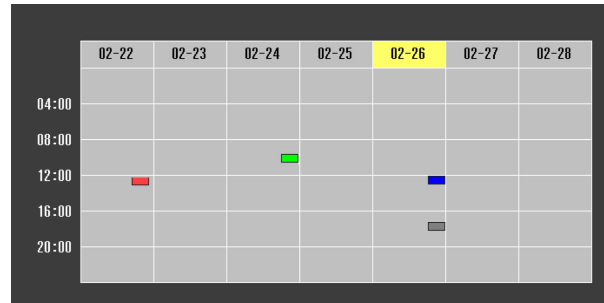

4. Select **Schedule** and press **Enter**.  
You see a screen like this:



Colored boxes on the calendar indicate the following:

- Blue box: One-time event
- Red box: Repeating event
- Green box: Communication is on or off
- Gray box: Event is invalid

5. To view an event, press the left and right arrow buttons on the remote to select a day.

The screen displays the details of the events scheduled for that day. A  blue icon indicates an enabled event; a  gray icon indicates a disabled event, and the  icon indicates a repeating event.

**Parent topic:** [Scheduling Projector Events](#)

## Editing a Scheduled Event

You can edit any currently scheduled event.

1. Press the **Menu** button.
2. Select the **Extended** menu and press **Enter**.
3. Select the **Schedule Settings** setting and press **Enter**.

You see a screen like this:

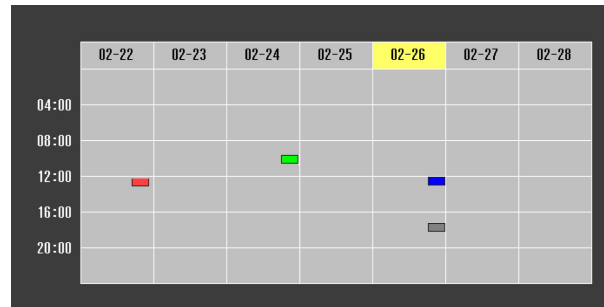

4. Press the left or right arrow buttons to highlight the date on the calendar containing the scheduled event you want to edit.
5. Press the up or down arrow buttons to highlight the event you want to edit, and press **Esc**.
6. Select one of the following:
  - **On/Off** to enable or disable the selected event.
  - **Edit** to edit the settings for the selected event.
  - **Clear** to delete the selected event.
  - **Add New** to add a new scheduled event.
7. When you are finished, select **Return** and press **Enter**.
8. Select **Setup complete** and select **Yes** to save your changes.

**Note:** To delete all scheduled events, select **Schedule Reset** and select **Yes**.

Parent topic: [Scheduling Projector Events](#)

## Projector Security Features

You can secure your projector to deter theft or prevent unintended use by setting up the following security features:

- Password security to prevent the projector from being turned on, and prevent changes to the startup screen and other settings.
- Button lock security to block operation of the projector using the buttons on the control panel.



- Security cabling to physically cable the projector in place.

[Password Security Types](#)

[Locking the Projector's Buttons](#)

[Installing a Security Cable](#)

**Parent topic:** [Adjusting Projector Features](#)

## Password Security Types

You can set up these types of password security using one shared password:

- **Power On Protection** password prevents anyone from using the projector without first entering a password.
- **User's Logo Protection** password prevents anyone from changing the custom screen the projector can display when it turns on. The presence of the custom screen discourages theft by identifying the projector's owner.
- **Network Protection** password prevents anyone from changing the network settings in the projector menus.
- **Schedule Protection** password prevents anyone from changing the projector's time or schedule settings.

[Setting a Password](#)

[Selecting Password Security Types](#)

[Entering a Password to Use the Projector](#)

[Saving a User's Logo Image to Display](#)

**Parent topic:** [Projector Security Features](#)

### Setting a Password

To use password security, you must set a password.

**Note:** The default password is set to **0000**.

1. Hold down the **Freeze** button on the remote control for about five seconds or until you see this menu.

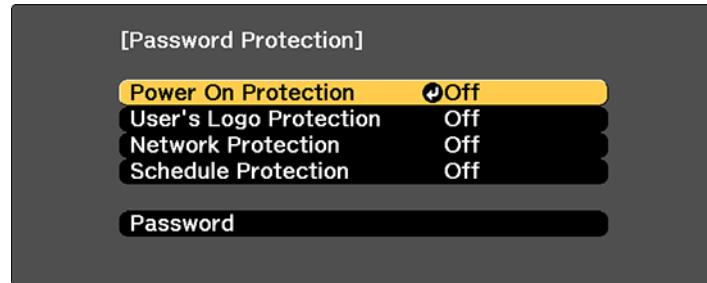

2. Press the down arrow to select **Password** and press **Enter**.  
You see the prompt "Change the password?".
3. Select **Yes** and press **Enter**.
4. Press and hold down the **Num** button on the remote control and use the numeric buttons to set a four-digit password.

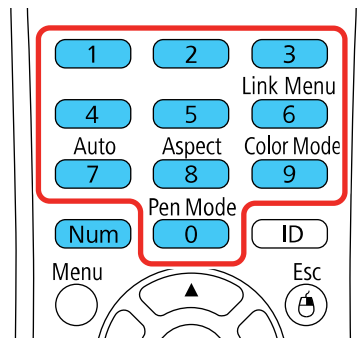

The password displays as \*\*\*\* as you enter it. Then you see the confirmation prompt.

5. Enter the password again.  
You see the message "Password accepted."
6. Press **Esc** to return to the menu.

7. Make a note of the password and keep it in a safe place in case you forget it.

Parent topic: [Password Security Types](#)

### Selecting Password Security Types

After setting a password, you see this menu, allowing you to select the password security types you want to use.

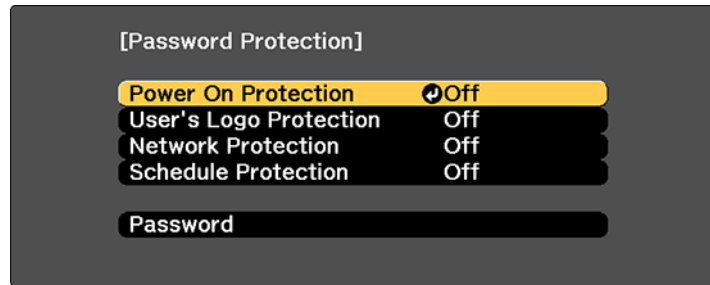

If you do not see this menu, hold down the **Freeze** button on the remote control for about five seconds or until the menu appears.

- To prevent unauthorized use of the projector, select **Power On Protection**, press **Enter**, select **On**, press **Enter** again, and press **Esc**.
- To prevent changes to the User's Logo screen or related display settings, select **User's Logo Protection**, press **Enter**, select **On**, press **Enter** again, and press **Esc**.
- To prevent changes to network settings, select **Network Protection**, press **Enter**, select **On**, press **Enter** again, and press **Esc**.
- To prevent changes to the projector's time or schedule settings, select **Schedule Protection**, press **Enter**, select **On**, press **Enter** again, and press **Esc**.

You can attach the Password Protect sticker to the projector as an additional theft deterrent.

**Note:** Be sure to keep the remote control in a safe place; if you lose it, you will not be able to enter the password required to use the projector.

Parent topic: [Password Security Types](#)

## Entering a Password to Use the Projector

If a password is set up and a **Power On Protection** password is enabled, you see a prompt to enter a password whenever you turn on the projector.

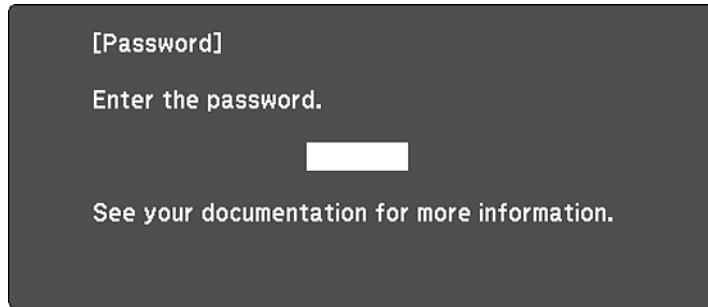

[0-9] :Enter

You must enter the correct password to use the projector.

1. Press and hold down the **Num** button on the remote control while you enter the password using the numeric buttons.

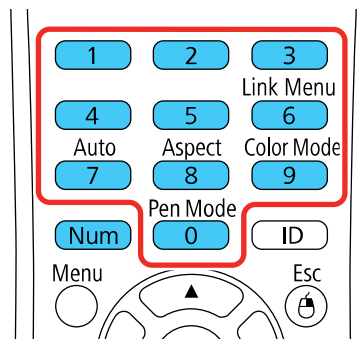

**Note:** The default password is **0000**.

The password screen closes.

2. If the password is incorrect, the following may happen:
  - You see a "wrong password" message and a prompt to try again. Enter the correct password to proceed.
  - If you have forgotten the password, make note of the **Request Code: xxxxx** number that appears on the screen and contact Epson Support.
  - If you enter an incorrect password three times in succession, you see a message telling you that the projector is locked. After the message is displayed for 5 minutes, the projector enters standby mode. Unplug the projector, plug in the power cord, and turn on the projector. You see a prompt to enter the password.
  - If you continue to enter an incorrect password many times in succession, the projector displays a request code and a message to contact Epson Support. Do not attempt to enter the password again. When you contact Epson Support, provide the displayed request code and proof of ownership for assistance in unlocking the projector.

**Parent topic:** [Password Security Types](#)

#### **Related references**

[Where to Get Help](#)

### **Saving a User's Logo Image to Display**

You can transfer an image to the projector and then display it whenever the projector turns on. You can also display the image when the projector is not receiving an input signal or when you temporarily stop projection. This transferred image is called the User's Logo screen.

The image you select as the User's Logo can be a photo, graphic, or company logo, which is useful in identifying the projector's owner to help deter theft. You can prevent changes to the User's Logo by setting up password protection for it.

**Note:** When you copy the menu settings from one projector to another using the batch setup feature, the user logo is also copied. Do not include any information in the user logo that you do not want to share between multiple projectors.

1. Display the image you want to project as the User's Logo.

2. Press the **Menu** button, select the **Extended** menu, and press **Enter**.

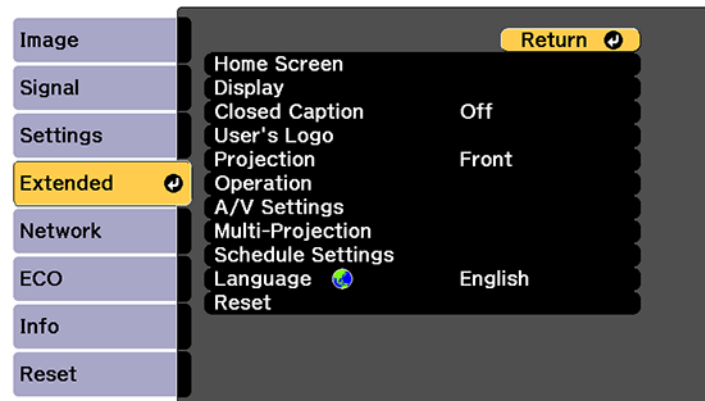

3. Select the **User's Logo** setting and press **Enter**.  
You see a prompt asking if you want to use the displayed image as a user's logo.
  4. Select **Yes** and press **Enter**.  
You see a selection box overlaying your image.
- Note:** When you select **User's Logo**, adjustments such as **Keystone**, **E-Zoom**, or **Aspect** are temporarily canceled.
5. Use the arrow buttons on the remote control to surround the image area you want to use as the User's Logo and press **Enter**.  
You see a prompt asking if you want to select this image area.
  6. Select **Yes** and press **Enter**. (If you want to change the selected area, select **No**, press **Enter**, and repeat the last step.)

You see the User's Logo zoom factor menu.

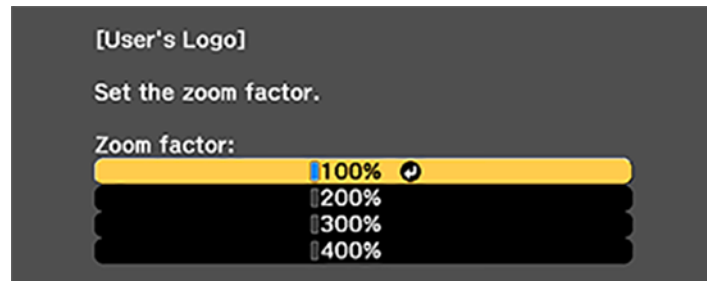

7. Select a zoom percentage and press **Enter**.  
You see a prompt asking if you want to save the image as the User's Logo.
8. Select **Yes** and press **Enter**.  
You see a completion message.
9. Press **Esc** to exit the message screen.
10. Select the **Extended** menu and press **Enter**.
11. Select **Display** and press **Enter**.
12. Select when you want to display the User's Logo screen:
  - To display it whenever there is no input signal, select **Display Background** and set it to **Logo**.
  - To display it whenever you turn the projector on, select **Startup Screen** and set it to **On**.

To prevent anyone from changing the User's Logo settings without first entering a password, set a password and enable User's Logo security.

**Parent topic:** [Password Security Types](#)

#### **Related tasks**

[Setting a Password](#)

[Selecting Password Security Types](#)

## **Locking the Projector's Buttons**

You can lock the buttons on the projector's control panel to prevent anyone from using the projector. You can lock all the buttons or all the buttons except the power button.

**Note:** The projector can still be operated using the remote control.

1. Press the **Menu** button.
2. Select the **Settings** menu and press **Enter**.

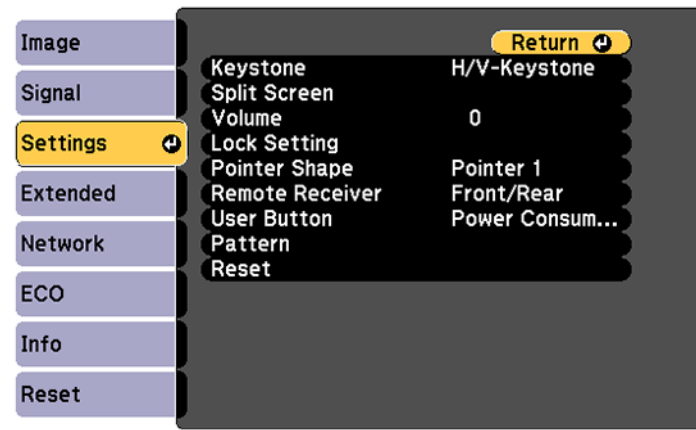
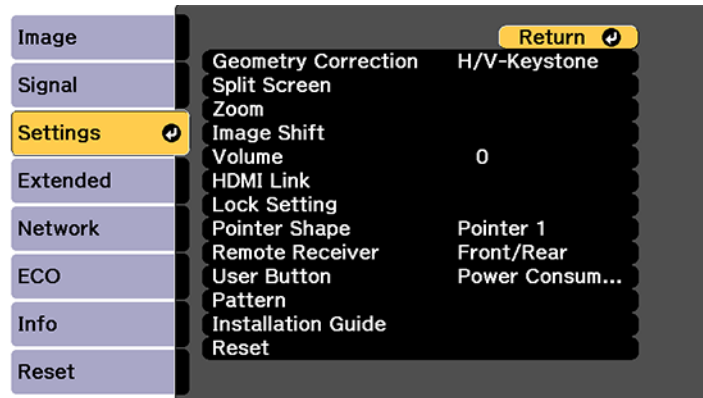

3. Select **Lock Setting** and press **Enter**.
4. Select the **Control Panel Lock** setting and press **Enter**.



5. Select one of these lock types and press **Enter**:
  - To lock all of the projector's buttons, select **Full Lock**.
  - To lock all buttons except the power button, select **Partial Lock**.

You see a confirmation prompt.

6. Select **Yes** and press **Enter**.

#### [Unlocking the Projector's Buttons](#)

**Parent topic:** [Projector Security Features](#)

### Unlocking the Projector's Buttons

If the projector's buttons have been locked, hold the **Enter** button on the projector's control panel for seven seconds to unlock them. You can also set the **Control Panel Lock** setting to **Off** in the Settings menu.

**Parent topic:** [Locking the Projector's Buttons](#)

### Installing a Security Cable

You can install two types of security cables on the projector to deter theft.

- Use the security slot on the projector to attach a Kensington lock. See your local computer or electronics dealer for purchase information.
- Use the security cable attachment point on the projector to attach a wire cable and secure it to a room fixture or heavy furniture.

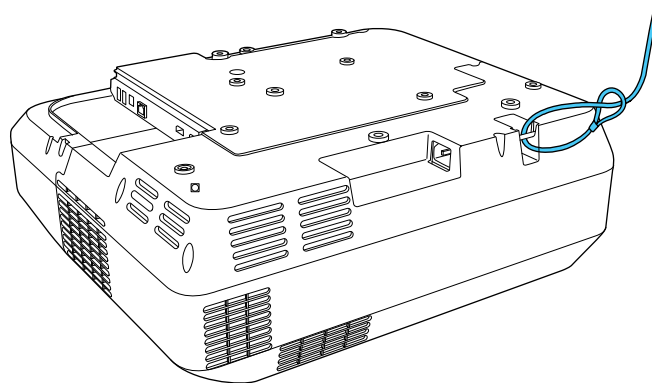

**Note:** Do not pass drop-prevention cables through the security cable attachment point when mounting the projector on a wall or ceiling.

Parent topic: [Projector Security Features](#)

## Creating a User Pattern to Display

You can transfer an image to the projector and then display it as a pattern to aid in presentations when you use the Pattern Display feature. This transferred image is called the User Pattern.

**Note:** Once you save a user pattern, you cannot restore the default pattern.

1. Display the image you want to project as the User Pattern from a connected computer or video source.
2. Press the **Menu** button, select the **Settings** menu, and press **Enter**.

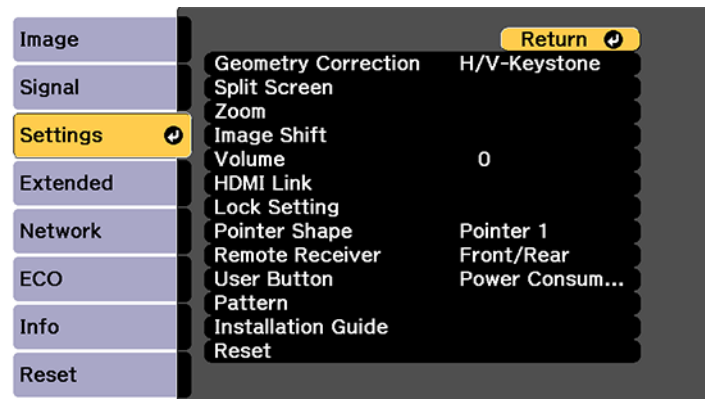

3. Select the **Pattern** setting and press **Enter**.
4. Select the **User Pattern** setting and press **Enter**.

You see a prompt asking if you want to use the displayed image as a User Pattern.

**Note:** When you select **User Pattern**, adjustments such as **Keystone**, **E-Zoom**, **Aspect**, **Adjust Zoom**, or **Image Shift** are temporarily canceled.

5. Select **Yes** and press **Enter**.

**Note:** It takes a few moments for the projector to save the image; do not use the projector, its remote control, or any connected equipment until it is finished.

You see a completion message.

6. Press **Esc** to exit the message screen.

**Parent topic:** [Adjusting Projector Features](#)

## Copying Menu Settings Between Projectors

After you select menu settings for your projector, you can transfer them to another projector of the same model.

**Note:** Copy the projector's settings before you adjust the projected image using the projector's Geometry Correction settings. Any saved User's Logo setting on the projector will transfer to the other projector.

**Caution:** If the copy process fails due to a power failure, communication error, or for any other reason, Epson will not be responsible for any repair costs incurred.

The following settings will not transfer between projectors:

- Info menu items
- Network menu settings other than those in the Notifications and Others menus

**Note:** In addition to the methods covered in this section, you can also copy and transfer settings to multiple projectors over a network using the EasyMP Network Updater software. See the online *EasyMP Network Updater Operation Guide* for instructions. You can download the latest software and documentation from the Epson website.

[Saving Settings to a USB Flash Drive](#)

[Transferring Settings from a USB Flash Drive](#)

[Saving Settings to a Computer](#)

[Transferring Settings from a Computer](#)

**Parent topic:** [Adjusting Projector Features](#)

## Saving Settings to a USB Flash Drive

You can save the projector settings you want to transfer to a USB flash drive.

**Note:** Use an empty flash drive. If the drive contains other files, the transfer may not complete correctly. The flash drive must use the FAT format and cannot have any security features.

1. Turn off the projector and unplug the power cord from the projector's power inlet.
2. Insert the flash drive into the **USB-A** port.

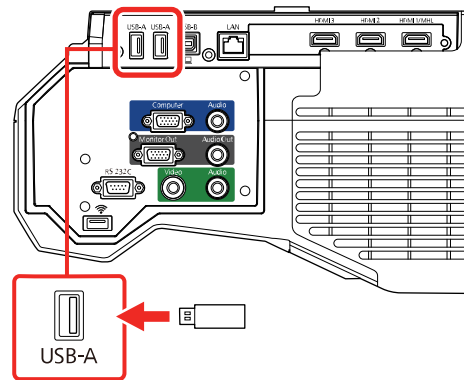

**Note:** Connect the flash drive directly to the projector. Do not use a hub or your settings may not be saved correctly.

3. Press and hold the **Esc** button on the control panel or remote control as you connect the power cord to the projector's power inlet.
4. When the On/Standby and Status lights are blue, and the Laser and Temp lights are orange, release the **Esc** button.

The lights flash to indicate that settings are transferring to the flash drive. When the lights stop flashing, the On/Standby light turns blue and the projector enters standby mode.

**Caution:** Do not unplug the power cord or remove the flash drive while the lights are flashing. This could damage the projector.

5. Once the projector enters standby mode, remove the flash drive.

Parent topic: [Copying Menu Settings Between Projectors](#)

## Transferring Settings from a USB Flash Drive

After saving projector settings to a USB flash drive, you can transfer them to another projector of the same model.

**Note:** Make sure the USB flash drive contains only a single settings transfer from another projector of the same model. The settings are contained in a file called **pjconfdata.bin**. If the drive contains other files, the transfer may not complete correctly.

Do not adjust image settings on a projector until after you transfer settings to it. Otherwise, you may have to repeat your adjustments.

1. Turn off the projector and unplug the power cord from the projector's power inlet.
2. Insert the flash drive into one of the USB-A ports.

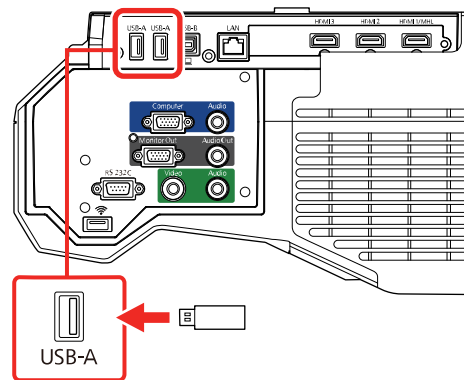

**Note:** Connect the flash drive directly to the projector. Do not use a hub or your settings may not be saved correctly.

3. Press and hold the **Menu** button on the control panel or remote control as you connect the power cord to the projector's power inlet.
4. When the On/Standby and Status lights are blue, and the Laser and Temp lights are orange, release the **Menu** button.

The lights flash to indicate that settings are transferring to the projector. When the lights stop flashing, the On/Standby light turns blue and the projector enters standby mode.

**Caution:** Do not unplug the power cord or remove the flash drive while the lights are flashing. This could damage the projector.

5. Once the projector enters standby mode, remove the flash drive.

**Parent topic:** [Copying Menu Settings Between Projectors](#)

## **Saving Settings to a Computer**

You can save the projector settings you want to transfer to a computer.

Your computer must be running one of the following operating systems:

- Windows Vista
- Windows 7
- Windows 8.x
- Windows 10
- OS X 10.7.x
- OS X 10.8.x
- OS X 10.9.x
- OS X 10.10.x
- OS X 10.11.x
- macOS 10.12.x
- macOS 10.13.x

1. Turn off the projector and unplug the power cord from the projector's power inlet.

2. Connect a USB cable to your projector's **USB-B** port.

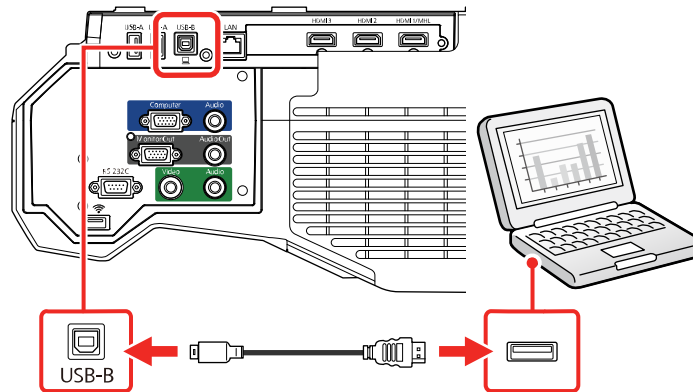

3. Connect the other end to any available USB port on your computer.
4. Press and hold the **Esc** button on the control panel or remote control as you connect the power cord to the projector's power inlet.
5. When the On/Standby and Status lights are blue, and the Laser and Temp lights are orange, release the **Esc** button.

The projector shows up as a removable disk on your computer.

6. Open the removable disk and copy the **pjconfdata.bin** file to your computer.
7. Once the file has copied, do one of the following:
  - **Windows:** Open the **My Computer**, **Computer**, or **Windows Explorer** utility. Right-click the name of your projector (listed as a removable disk) and select **Eject**.
  - **Mac:** Drag the removable disk icon for your projector from the desktop into the trash.

The projector enters standby mode when you disconnect the USB cable.

**Parent topic:** [Copying Menu Settings Between Projectors](#)

## Transferring Settings from a Computer

After saving projector settings to a computer, you can transfer them to another projector of the same model.

Your computer must be running one of the following operating systems:

- Windows Vista

- Windows 7
- Windows 8.x
- Windows 10
- OS X 10.7.x
- OS X 10.8.x
- OS X 10.9.x
- OS X 10.10.x
- OS X 10.11.x
- macOS 10.12.x
- macOS 10.13.x

Do not adjust image settings on a projector until after you transfer settings to it. Otherwise, you may have to repeat your adjustments.

1. Turn off the projector and unplug the power cord from the projector's power inlet.
2. Connect a USB cable to your projector's **USB-B** port.

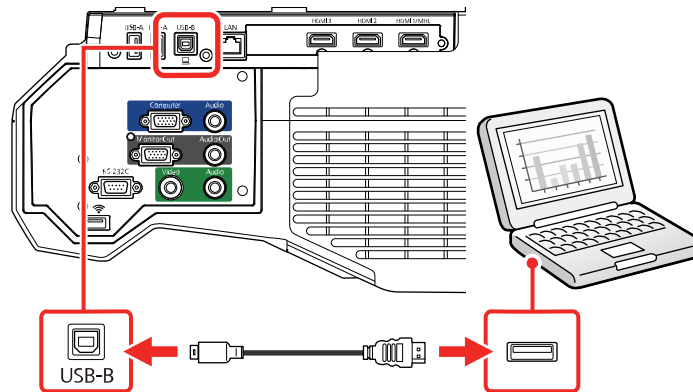

3. Connect the other end to any available USB port on your computer.
4. Press and hold the **Menu** button on the control panel or remote control as you connect the power cord to the projector's power inlet.
5. When the On/Standby and Status lights are blue, and the Laser and Temp lights are orange, release the **Menu** button.



The projector shows up as a removable disk on your computer.

6. Copy the **pjconfdata.bin** file from your computer to the removable disk.

**Note:** Do not copy any other files to the removable disk.

7. Once the file has copied, do one of the following:
  - **Windows:** Open the **My Computer**, **Computer**, or **Windows Explorer** utility. Right-click the name of your projector (listed as a removable disk) and select **Eject**.
  - **Mac:** Drag the removable disk icon for your projector from the desktop into the trash.

All the lights start flashing to indicate that the projector's settings are being updated. When the lights stop flashing, the On/Standby light turns blue and the projector enters standby mode.

**Caution:** Do not unplug the power cord while the lights are flashing. This could damage the projector.

**Parent topic:** [Copying Menu Settings Between Projectors](#)

---

# Adjusting the Menu Settings

Follow the instructions in these sections to access the projector menu system and change projector settings.

[Using the Projector's Menus](#)

[Image Quality Settings - Image Menu](#)

[Input Signal Settings - Signal Menu](#)

[Projector Feature Settings - Settings Menu](#)

[Projector Setup Settings - Extended Menu](#)

[Projector Network Settings - Network Menu](#)

[Projector Setup Settings - ECO Menu](#)

[Projector Information Display - Info Menu](#)

[Projector Reset Options - Reset Menu](#)

## Using the Projector's Menus

You can use the projector's menus to adjust the settings that control how your projector works. The projector displays the menus on the screen.

1. Press the **Menu** button on the control panel or remote control.

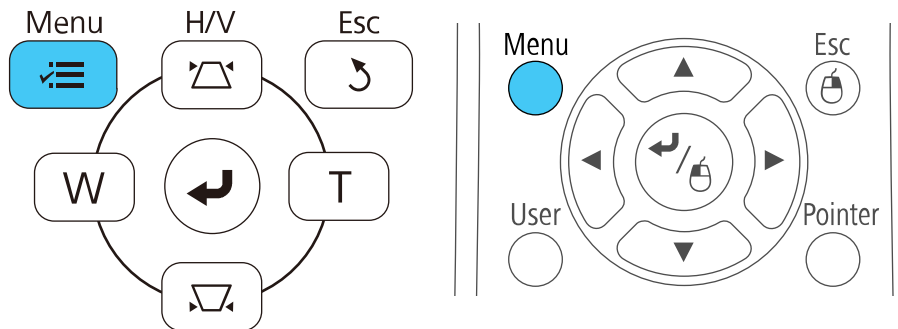

You see the menu screen displaying the Image menu settings.

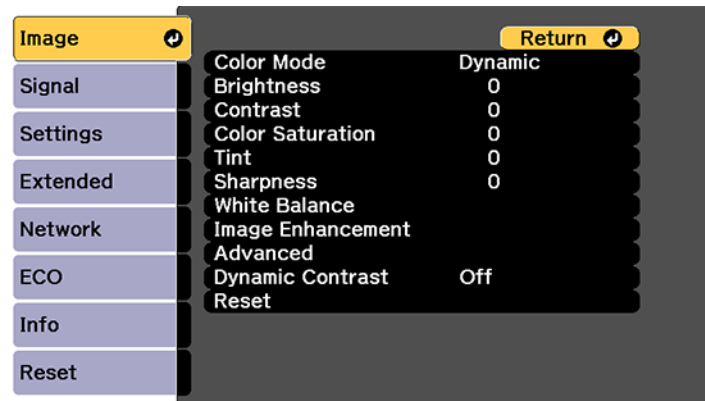

2. Press the up or down arrow button to move through the menus listed on the left. The settings for each menu are displayed on the right.

**Note:** The available settings depend on the current input source.

3. To change settings in the displayed menu, press **Enter**.
4. Press the up or down arrow button to move through the settings.
5. Change the settings using the buttons listed on the bottom of the menu screens.
6. To return all the menu settings to their default values, select **Reset**.
7. When you finish changing settings on a menu, press **Esc**.
8. Press **Menu** or **Esc** to exit the menus.

**Parent topic:** [Adjusting the Menu Settings](#)

## Image Quality Settings - Image Menu

Settings on the Image menu let you adjust the quality of your image for the input source you are currently using. The available settings depend on the currently selected input source.

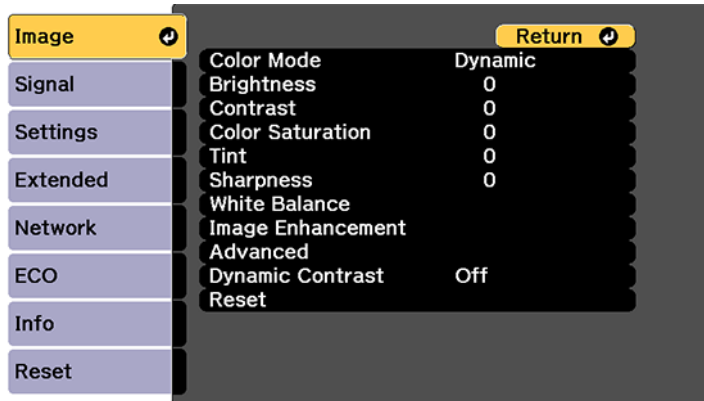

To change settings for an input source, make sure the source is connected and select that source.

Setting	Options	Description
<b>Color Mode</b>	See the list of available Color Modes	Adjusts the vividness of image colors for various image types and environments
<b>Brightness</b>	Varying levels available	Lightens or darkens the overall image
<b>Contrast</b>	Varying levels available	Adjusts the difference between light and dark areas of the image
<b>Color Saturation</b>	Varying levels available	Adjusts the intensity of the image colors
<b>Tint</b>	Varying levels available	Adjusts the balance of green to magenta tones in the image
<b>Sharpness</b>	Varying levels available	Adjusts the sharpness or softness of image details

Setting	Options	Description
<b>White Balance</b>	<b>Color Temp.</b> <b>G-M Correction</b> <b>Customized</b>	Sets the overall color tone of the image  <b>Color Temp.:</b> sets the color temperature according to the selected color mode; lower values tint the image red, and higher values tint the image blue  <b>G-M Correction:</b> makes fine adjustments to the color tone; higher values tint the image green and lower values tint the image red  <b>Customized:</b> adjusts the individual RGB components of the offset and gain
<b>Image Enhancement</b>	<b>Noise Reduction</b>	Reduces flickering in analog images

Setting	Options	Description
<b>Advanced</b>	<b>Gamma</b> <b>RGBCMY</b> <b>Deinterlacing</b>	<p><b>Gamma:</b> adjusts the colors by selecting one of the gamma correction values, referring to the projected image, or a gamma graph</p> <p><b>RGBCMY:</b> adjusts the hue, saturation, and brightness for each color</p> <p><b>Deinterlacing:</b> sets whether to convert interlaced-to-progressive signals for certain video image types</p> <ul style="list-style-type: none"> <li>• <b>Off:</b> for fast-moving video images</li> <li>• <b>Video:</b> for most video images</li> <li>• <b>Film/Auto:</b> for movies, computer graphics, and animation</li> </ul>
<b>Dynamic Contrast</b>	<b>Off</b> <b>Normal</b> <b>High Speed</b>	Adjusts the projected luminance based on the image brightness when certain Color Modes are selected

**Note:** The **Brightness** setting does not affect laser brightness. To change the laser brightness mode, use the **Brightness Settings** setting in the Eco menu.

**Parent topic:** [Adjusting the Menu Settings](#)

## Input Signal Settings - Signal Menu

Normally the projector detects and optimizes the input signal settings automatically. If you need to customize the settings, you can use the Signal menu. The available settings depend on the currently selected input source.

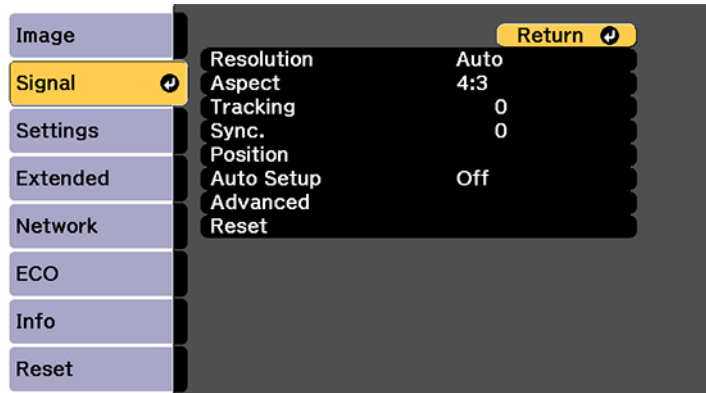

**Note:** You can restore the default settings of the **Position**, **Tracking**, and **Sync** settings by pressing the **Auto** button on the remote control.

To change settings for an input source, make sure the source is connected and select that source.

Setting	Options	Description
<b>Resolution</b>	<b>Auto</b> <b>Wide</b> <b>Normal</b>	Sets the input signal resolution if not detected automatically using the <b>Auto</b> option
<b>Aspect</b>	See the list of available aspect ratios	Sets the aspect ratio (width-to-height ratio) for the selected input source
<b>Tracking</b>	Varying levels available	Adjusts signal to eliminate vertical stripes in computer images
<b>Sync.</b>	Varying levels available	Adjusts signal to eliminate fuzziness or flickering in computer images
<b>Position</b>	Up, down, left, right	Adjusts the image location on the screen

Setting	Options	Description
<b>Auto Setup</b>	<b>On</b> <b>Off</b>	Automatically optimizes computer image quality
<b>Overscan</b>	<b>Auto</b> <b>Off</b> 4% 8%	Changes the projected image ratio to make the edges visible by a selectable percentage or automatically
<b>Advanced</b>	<b>HDMI Video Range</b> <b>Input Signal</b> <b>Video Signal</b>	<p><b>HDMI Video Range:</b> sets the video range to match the setting of the device connected to the HDMI input port</p> <ul style="list-style-type: none"> <li>• <b>Auto:</b> detects the video range automatically</li> <li>• <b>Normal:</b> normally for images from a device other than a computer; select if the black areas of the image are too bright</li> <li>• <b>Expanded:</b> normally for images from a computer; select if the image is too dark</li> </ul> <p><b>Input Signal:</b> specifies the signal type from input sources connected to computer ports</p> <ul style="list-style-type: none"> <li>• <b>Auto:</b> detects signals automatically</li> <li>• <b>RGB:</b> corrects color for computer/RGB video inputs</li> <li>• <b>Component:</b> corrects color for component video inputs</li> </ul> <p><b>Video Signal:</b> specifies the signal type from input sources connected to video ports; select <b>Auto</b> to automatically detect the signal</p>

Parent topic: [Adjusting the Menu Settings](#)



## Projector Feature Settings - Settings Menu

Options on the Settings menu let you customize various projector features.

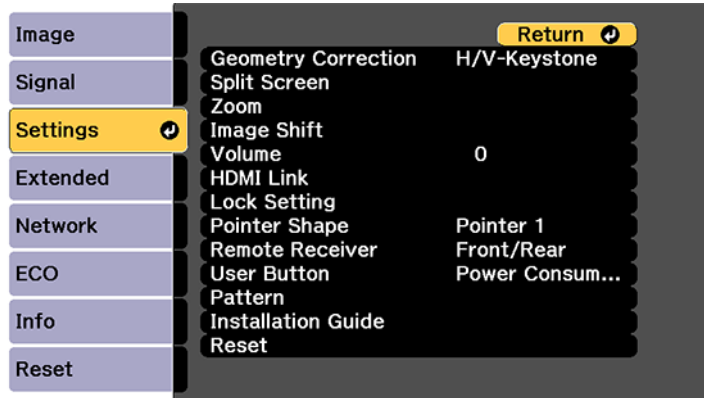

Setting	Options	Description
<b>Geometry Correction</b>	<b>H/V Keystone</b> <b>Quick Corner</b> <b>Arc Correction</b>	Adjusts image shape to rectangular (horizontally and vertically)  <b>H/V Keystone:</b> lets you manually correct horizontal and vertical sides  <b>Quick Corner:</b> select to correct image shape and alignment using an on-screen display  <b>Arc Correction:</b> select to adjust the curve or arc of the horizontal and vertical sides and load and save settings

Setting	Options	Description
<b>Split Screen</b>	—	Divides the viewing area horizontally and displays two images side-by-side; while in Split Screen mode, press <b>Menu</b> to display the Split Screen options or <b>Esc</b> to cancel split screen display
<b>Zoom</b>	Varying levels available	Adjusts the size of the projected image
<b>Image Shift</b>	Varying positions available	Adjusts the position of the projected image
<b>Volume</b>	Varying levels available	Adjusts the volume of projector's speaker system or external speakers

Setting	Options	Description
<b>HDMI Link</b>	<b>Device Connections</b> <b>HDMI Link</b> <b>Audio Out Device</b> <b>Power On Link</b> <b>Power Off Link</b> <b>Link Buffer</b>	Adjusts the HDMI Link options that allow the projector remote to control HDMI-connected devices that support the CEC standard  <b>Device Connections:</b> lists the devices connected to the <b>HDMI 1/MHL</b> , <b>HDMI 2</b> , and <b>HDMI 3</b> ports  <b>HDMI Link:</b> enables or disables the HDMI Link feature  <b>Audio Out Device:</b> selects whether to output audio from the internal speakers or a connected audio/video system  <b>Power On Link:</b> controls what happens when you turn on the projector or a linked device  <b>Power Off Link:</b> controls whether linked devices are turned off when the projector is turned off  <b>Link Buffer:</b> improves the performance of operations when the HDMI Link feature is not working correctly
<b>Lock Setting</b>	<b>Control Panel Lock</b>	Controls projector button locking to secure the projector  <b>Full Lock:</b> locks all buttons <b>Partial Lock:</b> locks all buttons except the power button <b>Off:</b> no buttons locked
<b>Pointer Shape</b>	Three shapes available	Changes the shape of the remote control pointer feature

Setting	Options	Description
Remote Receiver	Front/Rear Front Rear Off	Limits reception of remote control signals by the selected receiver; <b>Off</b> turns off all receivers
User Button	Light Source Mode Info Deinterlacing Closed Caption Resolution Pattern Display Display the QR Code Installation Guide	Assigns a menu option to the <b>User</b> button on the remote control for one-touch access
Pattern	Pattern Display Pattern Type User Pattern Test Pattern	Selects various pattern display options <b>Pattern Display:</b> lets you display the selected pattern type on the screen to aid in presentation <b>Pattern Type:</b> selects the type of grid or line pattern to display <b>User Pattern:</b> captures a projected screen and saves it as a pattern for display <b>Test Pattern:</b> displays a test pattern to assist in focusing and zooming the image and correcting image shape
Installation Guide	—	Displays an on-screen guide with instructions for installing and positioning the projector.

Parent topic: [Adjusting the Menu Settings](#)

## Projector Setup Settings - Extended Menu

Settings on the Extended menu let you customize various projector setup features that control its operation.

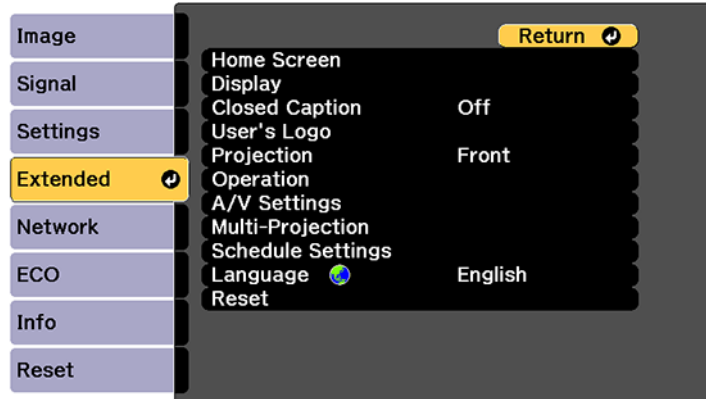

Setting	Options	Description
Home Screen	Home Screen Auto Disp. Custom Function 1 Custom Function 2	Adjusts settings on the Home Screen  <b>Home Screen Auto Disp.:</b> controls whether the Home screen displays automatically when the projector is turned on  <b>Custom Function 1</b> and <b>Custom Function 2:</b> let you customize the options displayed on the Home screen and save your settings as a preset

Setting	Options	Description
<b>Display</b>	<b>Messages</b> <b>Display Background</b> <b>Startup Screen</b> <b>Color Uniformity</b>	Selects various display options <b>Messages:</b> controls whether messages are displayed on the screen <b>Display Background:</b> selects the screen color or logo to display when no signal is received <b>Startup Screen:</b> controls whether a special screen appears when the projector starts up <b>Color Uniformity:</b> adjusts the color tone balance
<b>Closed Caption</b>	<b>Off</b> <b>CC1</b> <b>CC2</b>	Controls use of closed captions and selects the closed caption type (closed captions are only visible for NTSC signals connected through the <b>Video</b> port)
<b>User's Logo</b>	—	Creates a screen that the projector displays to identify itself and enhance security
<b>Projection</b>	<b>Front</b> <b>Front/Upside Down</b> <b>Rear</b> <b>Rear Upside Down</b>	Selects the way the projector faces the screen so the image is oriented correctly

Setting	Options	Description
<b>Operation</b>	<b>Direct Power On</b> <b>High Altitude Mode</b> <b>Auto Source Search</b> <b>Auto Power On</b> <b>Quick Startup</b> <b>Date &amp; Time</b>	Selects various operation options <p><b>Direct Power On:</b> lets you turn on the projector without pressing the power button</p> <p><b>High Altitude Mode:</b> regulates the projector's operating temperature at altitudes above 4921 feet (1500 m)</p> <p><b>Auto Source Search:</b> automatically detects the image signal that is input when the projector is turned on</p> <p><b>Auto Power On:</b> automatically turns on the projector when it detects an input signal from the selected port</p> <p><b>Quick Startup:</b> the projector enters this mode when you turn it off; you can start projecting in about five seconds by pressing the power button (set <b>A/V Output</b> to <b>While Projecting</b> first)</p> <p><b>Date &amp; Time:</b> adjusts the projector's date and time settings</p> <ul style="list-style-type: none"> <li>• <b>Daylight Savings Time:</b> enables daylight savings time</li> <li>• <b>Internet Time:</b> updates the time automatically via an online time server</li> </ul>

Setting	Options	Description
<b>A/V Settings</b>	<b>A/V Output</b> <b>Audio Output</b> <b>HDMI1 Audio Output</b> <b>HDMI2 Audio Output</b> <b>HDMI3 Audio Output</b>	<p>Selects the following when the projector is in standby mode (turned off):</p> <p><b>A/V Output:</b> the <b>Always On</b> setting lets the projector output audio and video signals even while it is standby mode; only available when <b>Standby Mode</b> is set to <b>Communication On</b></p> <p><b>Audio Output:</b> selects the audio input port when projecting images from non-HDMI ports</p> <p><b>HDMI1 Audio Output, HDMI2 Audio Output, and HDMI3 Audio Output:</b> select which Audio port provides audio when viewing images from HDMI ports</p>



Setting	Options	Description
<b>Multi-Projection</b>	<b>Multi-Projection</b> <b>Projector ID</b> <b>Color Mode</b> <b>Color Uniformity</b> <b>Brightness Settings</b> <b>Color Matching</b> <b>RGBCMY</b> <b>Reset</b>	Selects the following when you use multiple projectors: <b>Multi-Projection:</b> matches the display settings of multiple projectors <b>Projector ID:</b> assigns an ID for the projector when you use multiple projectors <b>Color Mode:</b> adjusts the vividness of image colors for various image types and environments <b>Color Uniformity:</b> adjusts the color tone balance <b>Brightness Settings:</b> selects the brightness mode of the projector <b>Color Matching:</b> corrects the difference in tint and brightness for each projected image <b>RGBCMY:</b> adjusts the hue, saturation, and brightness for each color <b>Reset:</b> resets all of the Multi-Projection settings to their default values
<b>Schedule Settings</b>	<b>Schedule</b> <b>Schedule Reset</b> <b>Setup Complete</b>	Schedules projector events to occur automatically at selected dates and times
<b>Language</b>	Various languages available	Selects the language for projector menu and message displays

**Note:** You cannot reset the following settings using the **Reset** option in the Extended menu:

- **Color Uniformity**
- **User's Logo**
- **Projection**
- **High Altitude Mode**
- **Auto Source Search**
- **Date & Time**
- **A/V Output**
- **Multi-Projection**
- **Projector ID**
- **Color Mode**
- **Color Matching**
- **Schedule Settings**
- **Language**

Parent topic: [Adjusting the Menu Settings](#)

## Projector Network Settings - Network Menu

Settings on the Network menu let you view network information and set up the projector for monitoring and control over a network.

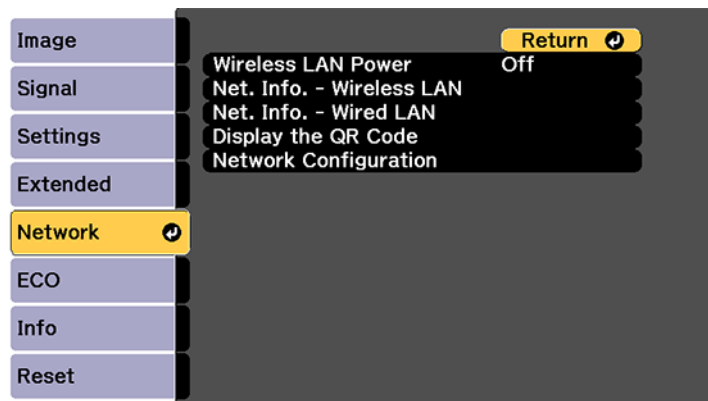

<b>Setting</b>	<b>Options</b>	<b>Description</b>
<b>Wireless LAN Power</b>	On Off	Enables or disables wireless communication
<b>Net. Info - Wireless LAN</b>	Connection mode Wireless LAN Sys. Antenna level Projector Name SSID DHCP IP Address Subnet Mask Gateway Address MAC Address Region Code	Displays wireless network status and details
<b>Net. Info - Wired LAN</b>	Projector Name DHCP IP Address Subnet Mask Gateway Address MAC Address	Displays wired network status and details
<b>Display the QR Code</b>	—	Displays the QR code for quick connection to a mobile device
<b>Network Configuration</b>	Accesses additional network menus	Configures your network settings

Parent topic: [Adjusting the Menu Settings](#)

## Projector Setup Settings - ECO Menu

Settings on the ECO menu let you customize projector functions to save power. When you select a power-saving setting, a leaf icon appears next to the menu item.

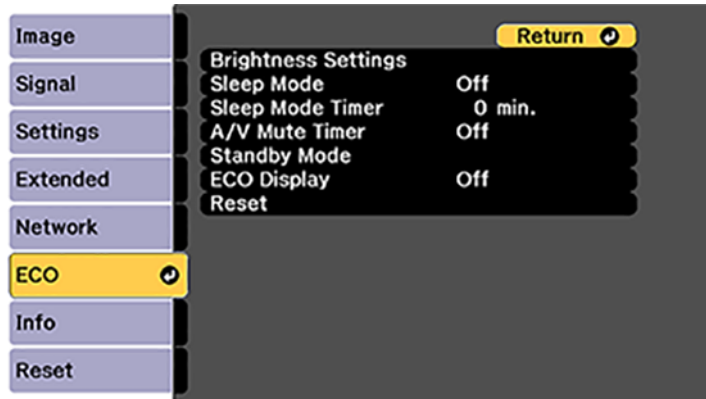

Setting	Options	Description
<b>Brightness Settings</b>	<b>Light Source Mode</b> <b>Brightness Level</b> <b>Constant Brightness</b> <b>Estimated Remains</b>	Selects the brightness mode of the projector laser  <b>Light Source Mode:</b> sets the brightness for the laser; the following settings are available: <ul style="list-style-type: none"> <li>• <b>Normal</b> sets maximum brightness level</li> <li>• <b>Quiet</b> reduces laser brightness to 70% with reduced fan noise</li> <li>• <b>Extended</b> reduces laser brightness to 70% and saves power and laser life</li> <li>• <b>Custom</b> allows you to select a custom brightness level</li> </ul> <b>Brightness Level:</b> allows you to select a custom brightness level <b>Constant Brightness:</b> maintains a constant brightness level <b>Estimated Remains:</b> estimates how long the projector can maintain a constant brightness level
<b>Sleep Mode</b>	<b>On</b> <b>Off</b>	Automatically places the projector in standby mode after an interval of inactivity
<b>Sleep Mode Timer</b>	1 to 30 minutes	Sets the interval for Sleep Mode
<b>A/V Mute Timer</b>	<b>On</b> <b>Off</b>	Automatically turns off the projector after 30 minutes if <b>A/V Mute</b> is enabled

Setting	Options	Description
<b>Standby Mode</b>	<b>Standby Mode</b> <b>Port</b>	<p><b>Communication On:</b> indicates that the projector can be monitored and controlled over a network when the projector is in standby mode; enable this setting to allow the following operations to occur when the projector is in standby mode:</p> <ul style="list-style-type: none"> <li>• Monitor and control the projector over a network</li> <li>• Output audio and video to an external device (A/V Output must be set to <b>Always On</b>)</li> </ul> <p><b>Port:</b> selects the <b>Wired LAN</b> or <b>Wireless LAN</b> port to use while the <b>Standby Mode</b> setting is set to <b>Communication On</b></p>
<b>ECO Display</b>	<b>On</b> <b>Off</b>	Displays a leaf icon in the bottom left corner of the projected screen to indicate the power-saving status when the laser brightness changes

**Note:** The **Light Source Mode** setting is disabled if you turn on the **Multi-Projection** setting in the Extended menu.

**Parent topic:** [Adjusting the Menu Settings](#)

## Projector Information Display - Info Menu

You can display information about the projector and input sources by viewing the Info menu. However, you cannot change any settings in the menu.

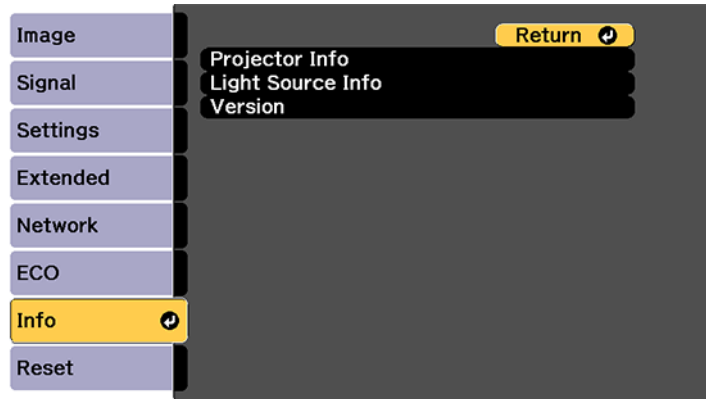

Select **Version** to display the projector's firmware version. Select **Light Source Info** to display the projector's light source information. Select **Projector Info** to display the settings described below.

Information item	Description
<b>Operation Hours</b>	Displays the number of hours ( <b>H</b> ) the projector has been used since it was turned on
<b>Source</b>	Displays the name of the port to which the current input source is connected
<b>Input Signal</b>	Displays the input signal setting of the current input source
<b>Resolution</b>	Displays the resolution of the current input source
<b>Video Signal</b>	Displays the video signal format of the current input source
<b>Refresh Rate</b>	Displays the refresh rate of the current input source
<b>Sync Info</b>	Displays information that may be needed by a service technician
<b>Status</b>	Displays information about projector problems that may be needed by a service technician
<b>Serial Number</b>	Displays the projector's serial number

Information item	Description
<b>Event ID</b>	Displays the Event ID number corresponding to a specific projector problem; see the list of Event ID codes

[Event ID Code List](#)

Parent topic: [Adjusting the Menu Settings](#)

## Event ID Code List

If the **Event ID** option on the Info menu displays a code number, check this list of Event ID codes for the solution to the projector problem associated with the code.

Event ID code	Cause and solution
0432	The network software did not start. Turn the projector off and then on again.
0435	
0433	Cannot display the transferred images. Restart the network software.
0434	Unstable network communication. Check the network communication status, wait a few moments, and try connecting to the network again.
0481	
0482	
0485	
0484	Communication with computer was disconnected. Restart the network software.
0483	The network software quit unexpectedly. Check the network communication status, then turn the projector off and then on again.
04FE	
0479	A projector system error has occurred. Turn the projector off and then on again.
04FF	
0891	Cannot find the SSID (network name). Make sure your computer and projector are connected to your access point's current SSID.
0892	The WPA/WPA2 authentication type does not match. Make sure the wireless network security settings are correct.
0893	The WEP/TKIP encryption type does not match. Make sure the wireless network security settings are correct.



Event ID code	Cause and solution
0894	Communication with unauthorized access point was disconnected. Contact your network administrator.
0898	Failed to acquire DHCP address. Make sure the DHCP server is operating correctly. If you are not using DHCP, turn off the <b>DHCP</b> setting in the Network menus.
0899	A communication error has occurred. Try restarting the network software and restarting your projector. If that does not solve the problem, contact Epson for help.
089A	The EAP authentication type does not match the network. Check the wireless LAN security settings and make sure that the security certificate is installed correctly.
089B	EAP server authentication failed. Check the wireless LAN security settings and make sure that the security certificate is installed correctly.
089C	EAP client authentication failed. Check the wireless LAN security settings and make sure that the security certificate is installed correctly.
089D	Key exchange failed. Check the wireless LAN security settings and make sure that the security certificate is installed correctly.
0920	The internal battery that saves the projector's date and time settings is running low. Contact Epson for help.

**Parent topic:** [Projector Information Display - Info Menu](#)

## Projector Reset Options - Reset Menu

You can reset most of the projector settings to their default values using the **Reset All Config** option on the Reset menu.

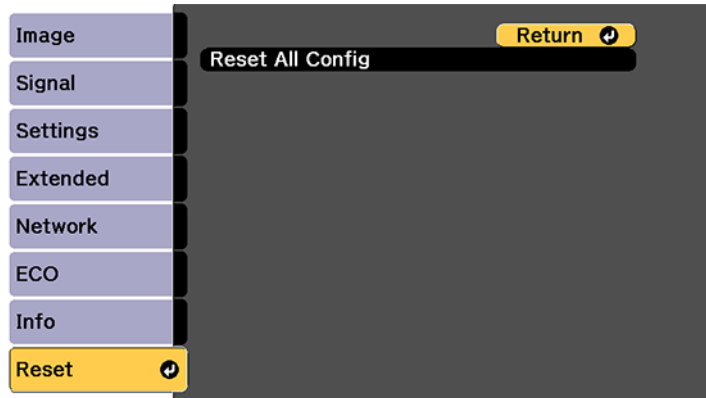

You cannot reset the following settings using the **Reset All Config** option:

- Input Signal
- Zoom
- Image Shift
- User's Logo
- Color Uniformity
- Color Matching
- Schedule Settings
- Language
- Date & Time
- Network menu items (Wireless LAN Power)
- Password
- Operation Hours
- Light Source Info

**Parent topic:** [Adjusting the Menu Settings](#)

---

# Maintaining and Transporting the Projector

Follow the instructions in these sections to maintain your projector and transport it from place to place.

[Projector Maintenance](#)

[Air Filter and Vent Maintenance](#)

[Replacing the Remote Control Batteries](#)

[Transporting the Projector](#)

## Projector Maintenance

Your projector needs little maintenance to keep working at its best.

You may need to clean the lens periodically, and clean the air filter and air vents to prevent the projector from overheating due to blocked ventilation.

The only parts you should replace are the air filter and remote control batteries. If any other part needs replacing, contact Epson or an authorized Epson servicer.

This projector uses a sealed laser light source which does not need servicing and cannot be replaced.

**Warning:** Before cleaning any part of the projector, turn it off and unplug the power cord. Never open any cover on the projector, except as specifically explained in this manual. Dangerous electrical voltages in the projector can injure you severely.

**Warning:** Do not try to service this product yourself, except as specifically explained in this manual. Refer all other servicing to qualified servicers.

[Cleaning the Projection Window](#)

[Cleaning the Obstacle Sensor](#)

[Cleaning the Projector Case](#)

**Parent topic:** [Maintaining and Transporting the Projector](#)

## Cleaning the Projection Window

Clean the projection window periodically, or whenever you notice dust or smudges on the surface.

- To remove dust or smudges, gently wipe the projection window with lens-cleaning paper.

- To remove stubborn smudges, moisten a soft, lint-free cloth with lens cleaner and gently wipe the projection window.

**Warning:** Do not use a lens cleaner that contains flammable gas. The high heat generated by the projector may cause a fire.

**Caution:** Do not use canned air, or the gases may leave a flammable residue.

**Parent topic:** [Projector Maintenance](#)

**Related tasks**

[Turning Off the Projector](#)

## Cleaning the Obstacle Sensor

Clean the projector's obstacle sensor glass (circled in red) periodically, or if you see a message telling you to remove any obstacles that are interfering with the projection area.

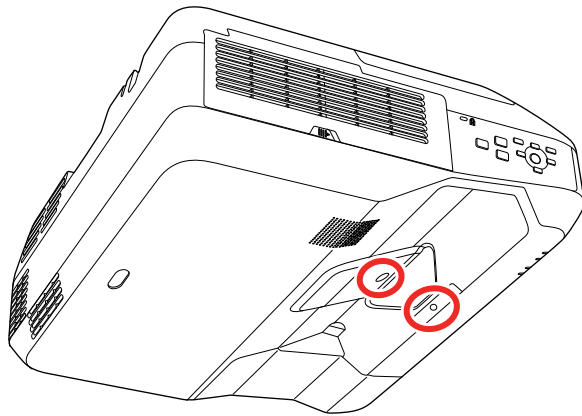

- To remove dust or smudges, gently wipe the obstacle sensor glass with lens-cleaning paper.
- To remove stubborn smudges, moisten a soft, lint-free cloth with lens cleaner and gently wipe the obstacle sensor glass.

**Warning:** Do not use a lens cleaner that contains flammable gas. The high heat generated by the projector may cause a fire.

**Caution:** Do not use canned air, or the gases may leave a flammable residue.

**Parent topic:** [Projector Maintenance](#)

**Related tasks**

[Turning Off the Projector](#)

## Cleaning the Projector Case

Before cleaning the projector case, turn off the projector and unplug the power cord.

- To remove dust or dirt, use a soft, dry, lint-free cloth.
- To remove stubborn dirt, use a soft cloth moistened with water and mild soap. Do not spray liquid directly on the projector.

**Caution:** Do not use wax, alcohol, benzene, paint thinner, or other chemicals to clean the projector case. These can damage the case. Do not use canned air, or the gases may leave a flammable residue.

**Parent topic:** [Projector Maintenance](#)

**Related tasks**

[Turning Off the Projector](#)

## Air Filter and Vent Maintenance

Regular filter maintenance is important to maintaining your projector. Your Epson projector is designed with an easily accessible, user-replaceable filter to protect your projector and make regular maintenance simple. Filter maintenance intervals will depend on the environment.

If regular maintenance is not performed, your Epson projector will notify you when the temperature inside the projector has reached a high level. Do not wait until this warning appears to maintain your projector filter as prolonged exposure to high temperatures may reduce the life of your projector or laser.

Damage due to the failure to properly maintain the projector or its filter may not be covered by the projector's Limited Warranty.

[Cleaning the Air Filter and Vents](#)

[Replacing the Air Filter](#)

**Parent topic:** [Maintaining and Transporting the Projector](#)

## Cleaning the Air Filter and Vents

Clean the projector's air filter or vents if they get dusty, or if you see a message telling you to clean them.

**Caution:** Do not use water or any detergent to clean the air filter. Do not use canned air, or the gases may leave a flammable residue.

1. Turn off the projector and unplug the power cord.
2. Slide the air filter cover latch and open the air filter cover.

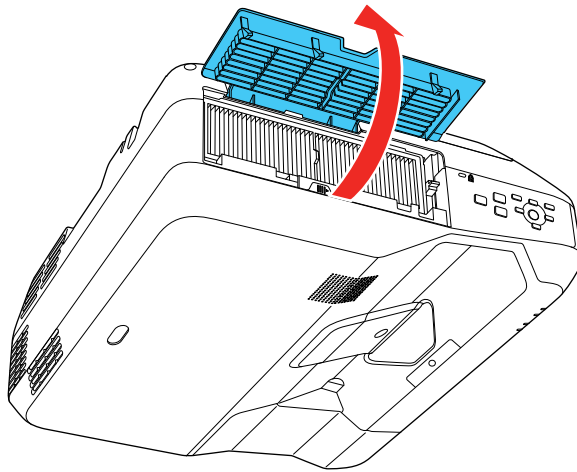
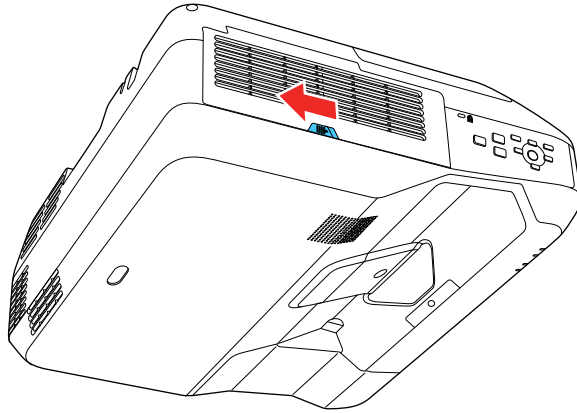

3. Pull the air filter out of the projector.

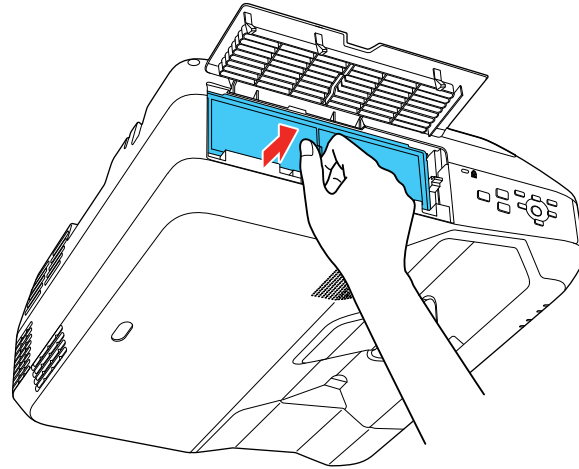

4. Tap each side of the filter 4 to 5 times to shake off any excess dust. Do this outside the room or away from the projector.

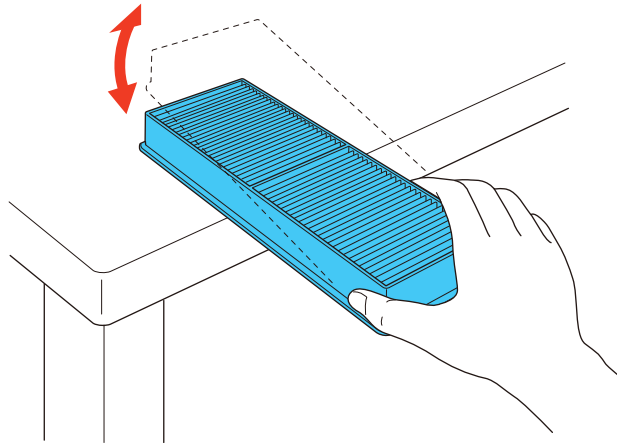

**Caution:** Do not use excessive force when tapping the air filter, or it may crack and become unusable. Do not rinse the air filter in water, or use any detergent or solvent to clean it. Do not use

canned air; the gases may leave a flammable residue, or push dust and debris into the projector's optics or other sensitive areas.

5. Vacuum the front of the air filter (the side with the tabs) to remove any remaining dust.

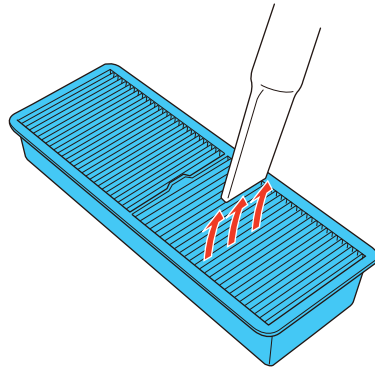

**Note:** If dust is difficult to remove or the air filter is damaged, replace the air filter.

6. Place the air filter back in the projector as shown.

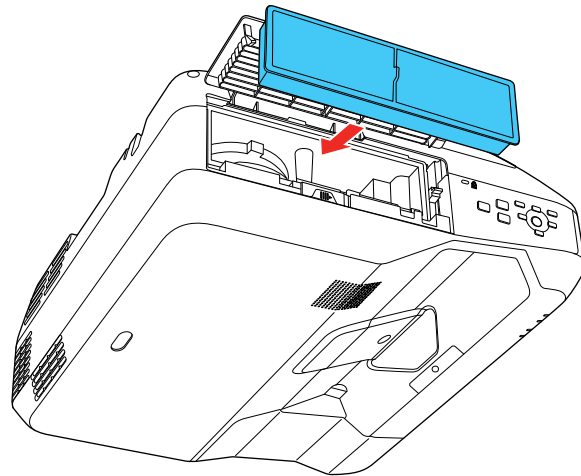



7. Close the air filter cover.

**Parent topic:** [Air Filter and Vent Maintenance](#)

**Related tasks**

[Turning Off the Projector](#)

## **Replacing the Air Filter**

You need to replace the air filter in the following situations:

- After cleaning the air filter, you see a message telling you to clean or replace it
- The air filter is torn or damaged

You can replace the air filter while the projector is mounted on the wall or ceiling.

1. Turn off the projector and unplug the power cord.

2. Slide the air filter cover latch and open the air filter cover.

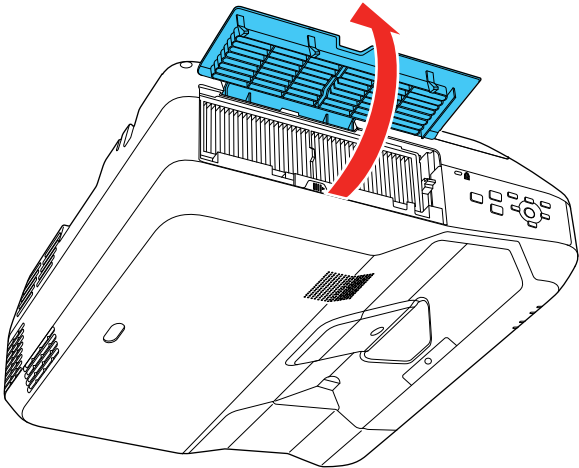
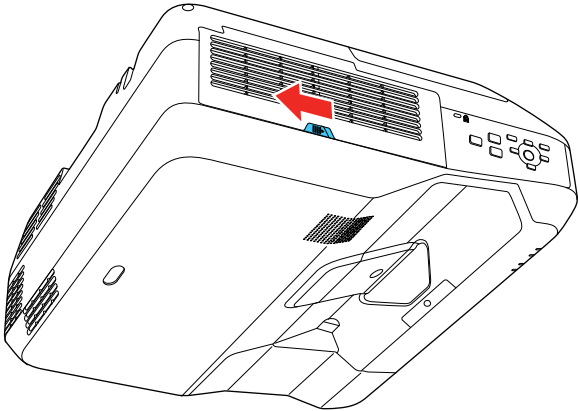

3. Pull the air filter out of the projector.

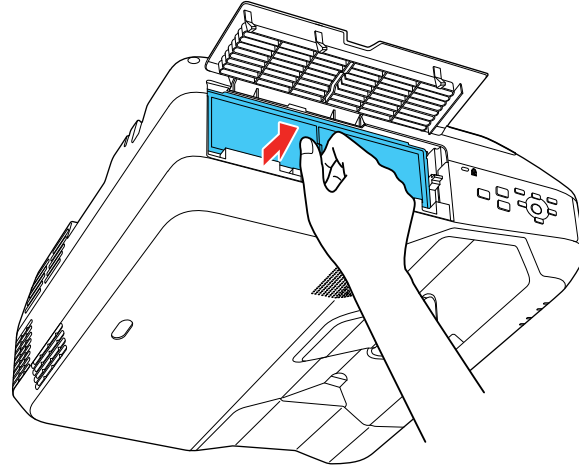

**Note:** Air filters contain polypropylene. Dispose of used air filters according to local regulations.

4. Place the new air filter in the projector as shown.

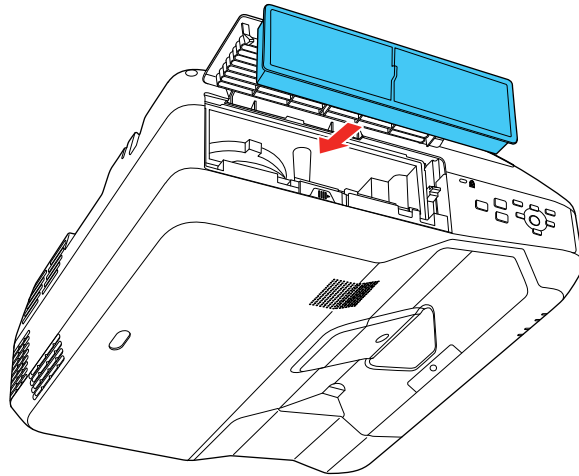

5. Close the air filter cover.

**Parent topic:** [Air Filter and Vent Maintenance](#)

**Related tasks**

[Turning Off the Projector](#)

## Replacing the Remote Control Batteries

The remote control uses two AA manganese or alkaline batteries. Replace the batteries as soon as they run out.

**Caution:** Use only the type of batteries specified in this manual. Do not install batteries of different types, or mix new and old batteries.

1. Remove the battery cover as shown.

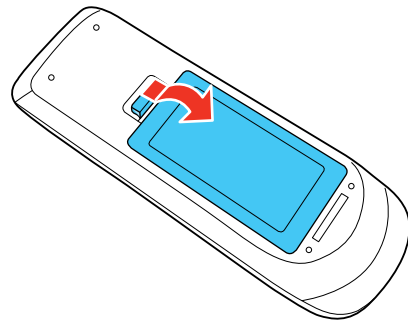

2. Remove the old batteries.

**Warning:** If the battery fluid has leaked, wipe it away with a soft cloth and avoid getting the fluid on your hands. If it gets on your hands, wash them immediately to avoid injury.

3. Insert the batteries with the + and – ends facing as shown.

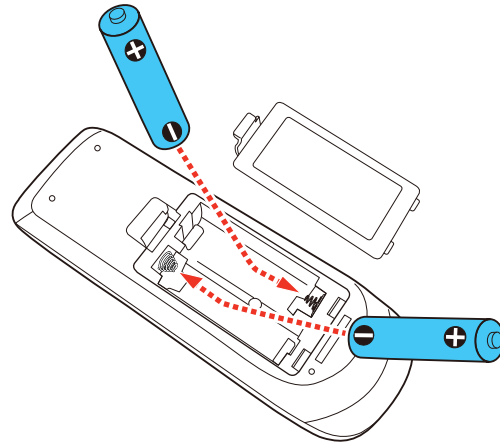

4. Replace the battery cover and press it down until it clicks into place.

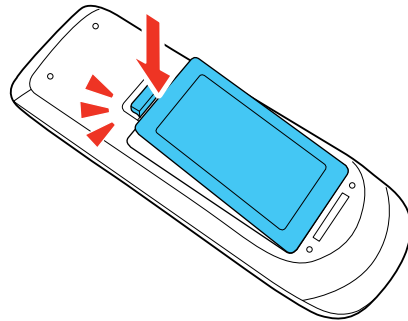

**Warning:** Dispose of used batteries according to local regulations. Do not expose batteries to heat or flame. Keep batteries out of the reach of children; they are choking hazards and are very dangerous if swallowed.

**Parent topic:** [Maintaining and Transporting the Projector](#)

## Transporting the Projector

The projector contains precision parts, some of which are glass. Follow the guidelines here to transport, ship, or store the projector safely.

1. Remove any equipment connected to the projector.
2. Do one of the following:
  - When transporting the projector a long distance or as checked luggage, pack it in a firm box with cushioning around it and mark the box "Fragile."
  - When shipping the projector for repairs, place it in its original packing materials, if possible, or use equivalent materials with cushioning around the projector. Mark the box "Fragile."

**Note:** Epson shall not be liable for any damages incurred during transportation.

**Parent topic:** [Maintaining and Transporting the Projector](#)

---

# Solving Problems

Check the solutions in these sections if you have any problems using the projector.

[Projection Problem Tips](#)

[Projector Light Status](#)

[Using the Projector Help Displays](#)

[Solving Image or Sound Problems](#)

[Solving Projector or Remote Control Operation Problems](#)

[Solving Network Problems](#)

[Where to Get Help](#)

## Projection Problem Tips

If the projector is not working properly, try turning it off and unplugging it. Then plug it back in and turn it on.

If this does not solve the problem, check the following:

- The lights on the projector may indicate what the problem is.
- The Help option on the Home screen can display information about common problems, if the projector is operating.
- The solutions in this manual can help you solve many problems.

If none of these solutions help, you can contact Epson for technical support.

**Parent topic:** [Solving Problems](#)

### Related references

[Projector Setup Settings - Extended Menu](#)

[Projector Light Status](#)

### Related tasks

[Cleaning the Obstacle Sensor](#)

[Cleaning the Air Filter and Vents](#)

[Replacing the Air Filter](#)

## Projector Light Status

The lights on the projector indicate the projector status and let you know when a problem occurs. Check the status and color of the lights and look for a solution in the table here.

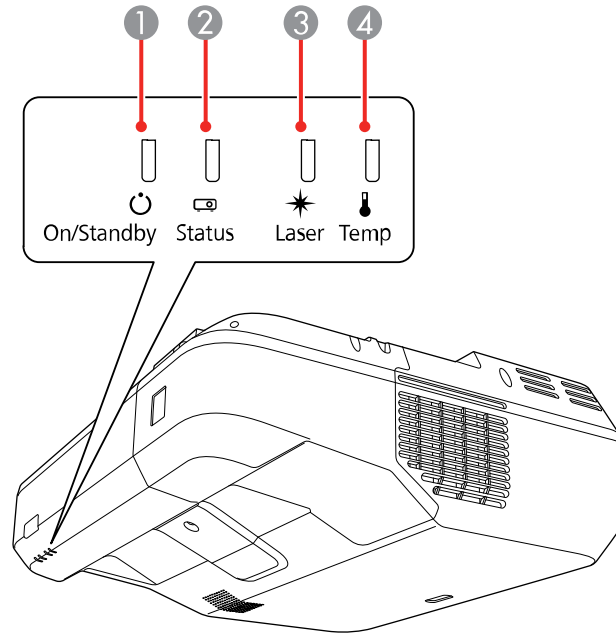

- 1 On/Standby light
- 2 Status light
- 3 Laser light
- 4 Temp (temperature) light

On/Standby light	Status light	Laser light	Temp light	Status and solution
Blue	Blue	Off	Off	Normal operation.



On/Standby light	Status light	Laser light	Temp light	Status and solution
Blue	Flashing blue	Off	Off	Warming up. Wait for an image to appear.
				Shutting down. (When the Status light stops flashing, you can unplug the projector.)
Blue	Off	Off	Off	Standby, sleep mode, or monitoring.
Flashing blue	Off	Off	Off	Preparing for monitoring or quick startup mode; all features are disabled.
Flashing blue	Varies	Varies	Flashing orange	<p>Projector is too hot.</p> <ul style="list-style-type: none"> <li>• Make sure that the vents and air filter are not clogged with dust or obstructed by nearby objects.</li> <li>• Clean or replace the air filter.</li> <li>• Make sure the environmental temperature is not too hot.</li> </ul>
Off	Flashing blue	Off	Orange	<p>Projector has overheated and turned off. Leave it turned off to cool down. After about five minutes, do the following:</p> <ul style="list-style-type: none"> <li>• Make sure that the vents and air filter are not clogged with dust or obstructed by nearby objects.</li> <li>• Clean or replace the air filter.</li> <li>• If operating the projector at high altitude, turn on <b>High Altitude Mode</b>.</li> <li>• If the problem persists, unplug the projector and contact Epson for help.</li> </ul>
Flashing blue	Varies	Flashing orange	Varies	Laser warning. Turn the projector off, unplug it, and contact Epson for help.

On/Standby light	Status light	Laser light	Temp light	Status and solution
Off	Flashing blue	Orange	Off	Laser has a problem. <ul style="list-style-type: none"> <li>• Make sure that the vents and air filter are not clogged with dust or obstructed by nearby objects.</li> <li>• Clean or replace the air filter.</li> <li>• If the problem persists, unplug the projector and contact Epson for help.</li> </ul>
Off	Flashing blue	Off	Flashing orange	A fan or sensor has a problem. Turn the projector off, unplug it, and contact Epson for help.
Off	Flashing blue	Flashing orange	Off	Internal projector error. Turn the projector off, unplug it, and contact Epson for help.
Flashing blue	Varies	Flashing orange	Flashing orange	Obstacle detection warning. A beep sounds and you see an obstacle warning. The projector turns off automatically if you take no action. <ul style="list-style-type: none"> <li>• Remove any obstacles interfering with the projection window.</li> <li>• Clean the obstacle sensor.</li> </ul> If the problem persists, turn the projector off, unplug it, and contact Epson for help.
Off	Flashing blue	Orange	Orange	Obstacle detection error. Turn the projector off, unplug it, and contact Epson for help.

**Note:** If the lights display a pattern not listed in the table above, turn the projector off, unplug it, and contact Epson for help.

**Parent topic:** [Solving Problems](#)

## Using the Projector Help Displays

You can display information to help you solve common problems using the projector's Help system.

1. Turn on the projector.
2. Press the **Home** button on the projector or the remote control.
3. Press the arrow buttons to select the  help icon and press **Enter**.
4. Select **Display the Help menu**.
5. Press **Enter**.

You see the Help menu.

6. Press the up and down arrow buttons to highlight the problem you want to solve.
7. Press **Enter** to view the solutions.
8. When you are finished, do one of the following:
  - To select another problem to solve, press **Esc**.
  - To exit the help system, press **Home**.

**Parent topic:** [Solving Problems](#)

## Solving Image or Sound Problems

Check the solutions in these sections if you have any problems with projected images or sound.

[Solutions When No Image Appears](#)

[Solutions When Image is Incorrect Using the USB Display Function](#)

[Solutions When "No Signal" Message Appears](#)

[Solutions When "Not Supported" Message Appears](#)

[Solutions When Only a Partial Image Appears](#)

[Solutions When the Image is Not Rectangular](#)

[Solutions When the Image Contains Noise or Static](#)

[Solutions When the Image is Fuzzy or Blurry](#)

[Solutions When the Image Brightness or Colors are Incorrect](#)

[Solutions to Sound Problems](#)

**Parent topic:** [Solving Problems](#)

## Solutions When No Image Appears

If no image appears, try the following solutions:

- Press the **A/V Mute** button on the remote control to see if the image was temporarily turned off.
- Make sure all necessary cables are securely connected and the power is on for the projector and connected video sources.
- Make sure the image being projected is not completely black (only when projecting computer images).
- Press the projector's power button to wake it from standby or sleep mode. Also see if your connected computer is in sleep mode or displaying a blank screen saver.
- Press the **Menu** button. If the projector menu is able to display, there may be a problem with the connected video source, cable connection, or port.
- Check the settings on the Signal menu to make sure they are correct for the current video source.
- Adjust the **Brightness** setting on the Image menu.
- Adjust the **Brightness Settings** on the Eco menu.
- Check the **Display** setting to make sure **Messages** is set to **On**.
- If the projector does not respond when you press the control panel buttons, the buttons may be locked. Unlock the buttons.
- If the projector does not respond when you press buttons on the remote control, make sure the remote receivers are turned on.
- For images projected with Windows Media Center, reduce the screen size from full screen mode.
- For images projected from applications using Windows DirectX, turn off DirectX functions.
- The projector may not be able to project copyrighted videos that you play back on a computer. For details, see the manual supplied with your computer.
- If the other solutions do not solve the problem, reset all of the projector settings using the options on the **Reset** menu.

**Parent topic:** [Solving Image or Sound Problems](#)

### **Related references**

[Input Signal Settings - Signal Menu](#)

[Projector Feature Settings - Settings Menu](#)

### **Related tasks**

[Controlling the Volume with the Volume Buttons](#)

[Selecting an Image Source](#)

## Solutions When Image is Incorrect Using the USB Display Function

If no image appears or if the image appears incorrectly using the USB Display function, try the following solutions:

- Press the **USB** button on the remote control.
- Press the **Source Search** button on the remote control or control panel, and select **USB Display**.
- Make sure the USB Display software has installed correctly. Install it manually if necessary.
- On a Mac, select the **USB Display** icon in the Dock or from the **Applications** folder.
- For images projected with Windows Media Center, reduce the screen size from full screen mode.
- For images projected from applications using Windows DirectX, turn off DirectX functions.
- If the mouse cursor flickers, select **Make the movement of the mouse pointer smooth** in the Epson USB Display Settings program on your computer.
- Turn off the **Transfer layered window** setting in the Epson USB Display Settings program on your computer.
- If you are projecting using the WUXGA (1920 × 1200) video format and change the computer resolution during projection, the video quality and performance may decline.
- Make sure you are using the most recent version of the USB Display software. You can download the latest version from the Epson web site. Go to [epson.com/support](http://epson.com/support) (U.S.) or [epson.ca/support](http://epson.ca/support) (Canada) and select your projector.

**Parent topic:** [Solving Image or Sound Problems](#)

### Related references

[Projector Setup Settings - Extended Menu](#)

### Related tasks

[Selecting an Image Source](#)

## Solutions When "No Signal" Message Appears

If the "No Signal" message appears, try the following solutions:

- Press the **Source Search** button and wait a few seconds for an image to appear.
- Press the **Home** button on the remote control to select from a list of available sources (shown in black text).

- Turn on the connected computer or video source, and press its play button to begin your presentation, if necessary.
- Check the connection from the projector to your video sources.
- If you are projecting from a laptop computer, make sure it is set up to display on an external monitor.
- If necessary, turn the projector and the connected computer or video source off and then on again.
- If you are projecting from an HDMI source, replace the HDMI cable with a shorter one.
- Connect the video source directly to the projector.
- If the other solutions do not solve the problem, reset all of the projector settings using the options on the **Reset** menu.

[Displaying From a PC Laptop](#)

[Displaying From a Mac Laptop](#)

**Parent topic:** [Solving Image or Sound Problems](#)

#### **Related tasks**

[Selecting an Image Source](#)

#### **Related topics**

[Connecting to Computer Sources](#)

### **Displaying From a PC Laptop**

If you see the "No Signal" message when you display from a PC laptop, you need to set up the laptop to display on an external monitor.

1. Hold down the laptop's **Fn** key and press the key labeled with a monitor icon or **CRT/LCD**. (See your laptop manual for details.) Wait a few seconds for an image to appear. To display on both the laptop's monitor and the projector, try pressing the same keys again.

**Note:** On Windows 7 or later, hold down the Windows key and press **P** at the same time, then click **Duplicate**.

2. If the same image is not displayed by the laptop and projector, check the Windows **Display** utility to make sure the external monitor port is enabled and extended desktop mode is disabled. (See your computer or Windows manual for instructions.)
3. If necessary, check your video card settings and set the multiple display option to **Clone**, **Mirror**, or **Duplicate**.

**Parent topic:** [Solutions When "No Signal" Message Appears](#)

## Displaying From a Mac Laptop

If you see the "No Signal" message when you display from a Mac laptop, you need to set up the laptop for mirrored display. (See your laptop manual for details.)

1. Open the **System Preferences** utility and select **Displays**, **Display**, or **Color LCD**.
2. Click the **Arrange** or **Arrangement** tab.
3. Select the **Mirror Displays** checkbox.

**Parent topic:** [Solutions When "No Signal" Message Appears](#)

## Solutions When "Not Supported" Message Appears

If the "Not Supported" message appears, try the following solutions:

- Make sure the input signal is supported by the projector.
- Make sure the computer's display resolution does not exceed the projector's resolution and frequency limit. If necessary, select a different display resolution for your computer. (See your computer manual for details.)
- As a test, try setting the computer's display resolution to the lowest possible setting, and then gradually increase it as necessary.

**Parent topic:** [Solving Image or Sound Problems](#)

### Related references

[Input Signal Settings - Signal Menu](#)

## Solutions When Only a Partial Image Appears

If only a partial computer image appears, try the following solutions:

- For VGA connections, press the **Auto** button on the remote control to optimize the image signal.
- Make sure the **Resolution** setting in the Signal menu is set correctly for the input signal.
- Try adjusting the image position using the **Position** menu setting.
- Press the **Aspect** button on the remote control to select a different image aspect ratio.
- If you zoomed into or out of the image using the **E-Zoom** buttons, press the **Esc** button until the projector returns to a full display.
- Check your computer display settings to disable dual display and set the resolution within the projector's limits. (See your computer manual for details.)

- Check the resolution assigned to your presentation files to see if they are created for a different resolution than you are projecting in. (See your software help for details.)
- Make sure you selected the correct **Projection** setting.
- Try adjusting the image position using the **Image Shift** setting.
- If you are passing the video signal through another device, make sure the device is set up correctly, then try connecting the video source directly to the projector.

**Parent topic:** [Solving Image or Sound Problems](#)

#### **Related references**

[Input Signal Settings - Signal Menu](#)

#### **Related tasks**

[Changing the Image Aspect Ratio](#)

[Zooming Into and Out of Images](#)

## **Solutions When the Image is Not Rectangular**

If the projected image is not evenly rectangular, try the following solutions:

- If the projector is not mounted on the wall or ceiling, place it directly in front of the center of the screen, facing it squarely, if possible.
- Use the **Image Shift** setting to adjust the image position, rather than moving the projector.
- Press the keystone buttons on the projector to adjust the image shape.
- Adjust the image shape using the **Geometry Correction** menu settings.

**Note:** If the projector is mounted on the wall, always use the adjustment dials on the mount to center the image.

**Parent topic:** [Solving Image or Sound Problems](#)

#### **Related tasks**

[Correcting Image Shape with the Keystone Buttons](#)

[Correcting Image Shape with Quick Corner](#)

[Correcting Image Shape with Arc Correction](#)



## Solutions When the Image Contains Noise or Static

If the projected image seems to contain electronic interference (noise) or static, try the following solutions:

- Check the cables connecting your computer or video source to the projector. They should be:
  - Separated from the power cord to prevent interference
  - Securely connected at both ends
  - Not connected to an extension cable
  - No longer than 10 feet (3 m) for VGA/computer cables or 24 feet (7.3 m) for HDMI cables
- Check the settings on the projector's Signal menu to make sure they match the video source. If available for your video source, adjust the **Deinterlacing** and **Noise Reduction** settings.
- Select a computer video resolution and refresh rate that are compatible with the projector.
- If you are projecting from a computer, press the **Auto** button on the remote control to automatically adjust the tracking and sync. If the problem remains, display a uniformly patterned image on the screen and manually adjust the **Tracking** and **Sync** settings.
- If you adjusted the image shape using the projector controls, try decreasing the **Sharpness** setting to improve image quality.
- If you connected an extension power cable, try projecting without it to see if it caused interference in the signal.
- If you are using the USB Display function, turn off the **Transfer layered window** setting in the Epson USB Display Settings program on your computer.

**Parent topic:** [Solving Image or Sound Problems](#)

### Related references

[Input Signal Settings - Signal Menu](#)

[Supported Video Display Formats](#)

### Related topics

[Connecting to Computer Sources](#)

[Connecting to Video Sources](#)

## Solutions When the Image is Fuzzy or Blurry

If the projected image is fuzzy or blurry, try the following solutions:

- Adjust the image focus.

- Clean the projection window.

**Note:** To avoid condensation on the lens after bringing the projector in from a cold environment, let the projector warm up to room temperature before using it.

- Position the projector close enough to the screen, and directly in front of it.
- Verify that the throw distance from the projector to your projection surface meets the specifications in the *Installation Guide* included with your mount.
- Position the projector so the keystone adjustment angle is not so wide that it distorts the image.
- Adjust the **Sharpness** setting to improve image quality.
- If you are projecting from a computer using a VGA cable, press the **Auto** button on the remote control to automatically adjust the tracking and sync. If any bands or overall blurriness remain, display a uniformly patterned image on the screen and manually adjust the **Tracking** and **Sync** settings.
- If you are projecting from a computer, adjust the computer's resolution to match the projector's native resolution, if possible.
- Reset the keystone, **Quick Corner**, and **Arc Correction** settings to their factory defaults and refocus the image.

**Note:** If the projector is mounted on the wall, always use the adjustment dials on the mount to center the image.

- Make sure the screen is flat.

**Parent topic:** [Solving Image or Sound Problems](#)

**Related references**

[Input Signal Settings - Signal Menu](#)

[Image Quality Settings - Image Menu](#)

**Related tasks**

[Focusing the Image](#)

## Solutions When the Image Brightness or Colors are Incorrect

If the projected image is too dark or light, or the colors are incorrect, try the following solutions:

- Press the **Color Mode** button on the remote control to try different color modes for the image and environment.
- Check your video source settings.

- Adjust the available settings on the Image menu for the current input source, such as **Brightness**, **Contrast**, **Tint**, **White Balance**, and/or **Color Saturation**.
- Make sure you selected the correct **Input Signal** or **Video Signal** setting on the Signal menu, if available for your image source.
- Make sure you selected the correct **Gamma** or **RGBCMY** setting in the Image menu.
- Make sure all the cables are securely connected to the projector and your video device. If you connected long cables, try connecting shorter cables.
- Make sure the **Brightness Settings** in the Eco menu is set correctly.
- Position the projector close enough to the screen.
- If the above solutions do not correct your image, try resetting all of the projector's settings using the Reset menu.

**Parent topic:** [Solving Image or Sound Problems](#)

#### **Related references**

[Input Signal Settings - Signal Menu](#)

[Projector Setup Settings - ECO Menu](#)

[Image Quality Settings - Image Menu](#)

#### **Related topics**

[Connecting to Computer Sources](#)

[Connecting to Video Sources](#)

## **Solutions to Sound Problems**

If there is no sound when you expect it or the volume is too low or high, try the following solutions:

- Adjust the projector's volume settings.
- Press the **A/V Mute** button on the remote control to resume video and audio if they were temporarily stopped.
- Press the **Source Search** button to switch to the correct input source, if necessary.
- Check your computer or video source to make sure the volume is turned up and the audio output is set for the correct source.
- Try disconnecting and reconnecting the audio cable.
- Check the audio cable connections between the projector and your video source.
- If you do not hear sound from an HDMI source, set the connected device to PCM output.

- Make sure any connected audio cables are labeled "No Resistance".
- If you are using the USB Display function, turn on the **Output audio from the projector** setting in the Epson USB Display Settings program on your computer.
- If you are using a Mac and you do not hear sound from an HDMI source, make sure your Mac supports audio through the HDMI port. If not, you need to connect an audio cable.
- If you want to use a connected audio source when the projector is off, set the **Quick Startup** option to **Off** and make sure the **A/V Settings** options are set correctly.
- If the volume for the computer is set to the minimum while the projector's volume is set to maximum, the noise may be mixed. Turn up the computer's volume and decrease the projector's volume.
- Make sure the **Audio Output Device** option is set to the correct audio port for your video device.
- If you turn the projector on immediately after turning it off, the cooling fans may run at high speed momentarily and cause an unexpected noise. This is normal.

**Parent topic:** [Solving Image or Sound Problems](#)

#### **Related references**

[Projector Setup Settings - ECO Menu](#)

#### **Related tasks**

[Shutting Off the Picture and Sound Temporarily](#)

## **Solving Projector or Remote Control Operation Problems**

Check the solutions in these sections if you have problems operating the projector or remote control.

[Solutions to Projector Power or Shut-Off Problems](#)

[Solutions to Problems with the Remote Control](#)

[Solutions to Password Problems](#)

**Parent topic:** [Solving Problems](#)

### **Solutions to Projector Power or Shut-Off Problems**

If the projector does not come on when you press the power button or it shuts off unexpectedly, try the following solutions:

- Make sure the power cord is securely connected to the projector and to a working electrical outlet.
- The projector's buttons may be locked for security. Unlock the buttons or use the remote control to turn on the projector.

- If the projector's laser shuts off unexpectedly, it may have entered standby mode after a period of inactivity. Press the power button to wake the projector and adjust the **Sleep Mode Timer** setting to change the sleep interval. The **A/V Mute Timer** may be set. Set the **A/V Mute Timer** to **Off** in the ECO menu.
- If the projector's laser shuts off, the Status light is flashing, and the Temp light is on, the projector has overheated and shut off. Check the solutions for this light status.
- If the power button on the remote control does not turn on the projector, check its batteries and make sure the **Remote Receiver** setting is turned on in the projector's menu, if available.
- Make sure **Sleep Mode** is not in effect.
- The power cord may be defective. Try another power cord. If that doesn't work, disconnect the cord and contact Epson.
- Temporarily remove the Ethernet cable and see if the problem continues.

**Parent topic:** [Solving Projector or Remote Control Operation Problems](#)

**Related references**

[Projector Light Status](#)

[Projector Feature Settings - Settings Menu](#)

**Related tasks**

[Unlocking the Projector's Buttons](#)

## Solutions to Problems with the Remote Control

If the projector does not respond to remote control commands, try the following solutions:

- Check that the remote control batteries are installed correctly and have power. If necessary, replace the batteries.
- Make sure you are operating the remote control within the reception angle and range of the projector.
- Make sure the projector is not warming up or shutting down.
- Check to see if a button on the remote control is stuck down, causing it to enter sleep mode. Release the button to wake the remote control up.
- Strong fluorescent lighting, direct sunlight, or infrared device signals may be interfering with the projector's remote receivers. Dim the lights or move the projector away from the sun or interfering equipment.
- If available, turn on one of the remote receivers in the projector's menu system, or check if all the remote receivers were turned off.

- If the remote receiver setting is off, press and hold the **Menu** button on the remote for at least 15 seconds to restore the default setting.
- If you assigned an ID number to the remote control to operate multiple projectors, you may need to check or change the ID setting (feature not available with all projectors).
- If you lose the remote control, you can purchase another from an authorized Epson reseller.

**Parent topic:** [Solving Projector or Remote Control Operation Problems](#)

**Related references**

[Remote Control Operation](#)

**Related tasks**

[Replacing the Remote Control Batteries](#)

## Solutions to Password Problems

If you cannot enter or remember a password, try the following solutions:

- You may have turned on password protection without first setting a password. Try entering **0000** using the remote control.
- If you have entered an incorrect password too many times and see a message displaying a request code, write down the code and contact Epson. Do not attempt to enter the password again. Provide the request code and proof of ownership for assistance in unlocking the projector.
- If you set a Epson Web Control password and forgot the user ID or password, try entering the following:
  - User ID: **EPSONWEB**
  - Default password: **admin**
- If you set a Remote password (in Epson Web Control) and forgot the user ID or password, try entering the following:
  - User ID: **EPSONREMOTE**
  - Default password: **guest**
- If you lose the remote control, you cannot enter a password. Order a new one from Epson.

**Parent topic:** [Solving Projector or Remote Control Operation Problems](#)

**Related concepts**

[Projector Security Features](#)

## Solving Network Problems

Check the solutions in these sections if you have problems using the projector on a network.

[Solutions When Wireless Authentication Fails](#)

[Solutions When You Cannot Access the Projector Through the Web](#)

[Solutions When Network Alert E-Mails are Not Received](#)

[Solutions When the Image Contains Static During Network Projection](#)

**Parent topic:** [Solving Problems](#)

### Solutions When Wireless Authentication Fails

If you cannot authenticate a wireless connection, try the following solutions:

- If the wireless settings are correct, but authentication fails, you may need to update the **Date & Time** settings on the Extended menu, if available.
- Make sure the **Wireless LAN Power** setting is set to **On**.
- Check the Security settings and passphrase in the Network Configuration menu.
- Check the Event ID number displayed in the Info menu and check the link below to identify the problem.

**Parent topic:** [Solving Network Problems](#)

#### Related references

[Projector Network Settings - Network Menu](#)

### Solutions When You Cannot Access the Projector Through the Web

If you are unable to access the projector through a web browser, make sure you are using the correct ID and password, which are case sensitive.

**Note:** You cannot change the user ID.

- You may need to log in to access some options on the Web Control screen. If you see a log in window, enter **EPSONWEB** as the user ID and enter the password set in the projector's Network menu as the password. The default password is **admin**.
- To display the Web Remote screen, enter **EPSONREMOTE** as the user ID and enter the password set in the projector's Network menu as the password. The default password is **guest**.
- Avoid connecting via a proxy server.

- Make sure you have access to the network the projector is on.
- Check the IP address on the projector, then reenter the IP address in the browser search bar.

**Note:** The user ID and password are case sensitive.

**Parent topic:** [Solving Network Problems](#)

## Solutions When Network Alert E-Mails are Not Received

If you do not receive an e-mail alerting you to problems with a projector over the network, try the following solutions:

- Make sure the projector is turned on and connected to the network correctly. (If an error shut down the projector, it cannot send an e-mail.)
- Make sure your electrical outlet or power source is functioning properly.
- Make sure you set up the projector e-mail alert settings correctly on the projector's network Notifications menu or in the network software.
- Set the **Standby Mode** setting to **Communication On** so the network software can monitor the projector in standby mode. Change the **Port** setting according to your network environment.

**Parent topic:** [Solving Network Problems](#)

### Related references

[Network Projector E-mail Alert Messages](#)

### Related tasks

[Setting Up Projector Network E-Mail Alerts](#)

## Solutions When the Image Contains Static During Network Projection

If the projected image contains static during network projection, try the following solutions:

- Check for any obstacles between the access point, the computer, the mobile device, and the projector. If necessary, change their positions to improve communication. Also, make sure that they are not too far apart. Move them closer together and try to connect again.
- If the wireless connection is slow or your projected image contains noise, check for interference from other equipment, such as a Bluetooth device or microwave. Move the interfering device farther away or expand your wireless bandwidth.
- If the connection speed declines, reduce the number of connected devices.

**Parent topic:** [Solving Network Problems](#)



## Where to Get Help

If you need to contact Epson for technical support services, use the following support options.

### Internet Support

Visit Epson's support website at [epson.com/support](http://epson.com/support) (U.S.), [epson.ca/support](http://epson.ca/support) (Canada), or [epson.com.jm/support](http://epson.com.jm/support) (Caribbean) and select your product for solutions to common problems with your projector. You can download utilities and documentation, get FAQs and troubleshooting advice, or e-mail Epson with your questions.

### Speak to a Support Representative

To use the Epson PrivateLine Support service, call (800) 637-7661. This service is available for the duration of your warranty period. You may also speak with a projector support specialist by dialing (562) 276-4394 (U.S.) or (905) 709-3839 (Canada).

Support hours are 6 AM to 8 PM, Pacific Time, Monday through Friday and 7 AM to 4 PM, Pacific Time, Saturday.

Days and hours of support are subject to change without notice. Toll or long distance charges may apply.

Before you call, have the following information ready:

- Product name
- Product serial number (located on the bottom or rear of the projector, or in the menu system)
- Proof of purchase (such as a store receipt) and date of purchase
- Computer or video configuration
- Description of the problem

### Purchase Supplies and Accessories

You can purchase screens, other optional accessories, and replacement parts from an Epson authorized reseller. To find the nearest reseller, call 800-GO-EPSON (800-463-7766) in the U.S. or 800-807-7766 in Canada. Or you can purchase online at [epsonstore.com](http://epsonstore.com) (U.S. sales) or [epsonstore.ca](http://epsonstore.ca) (Canadian sales).

To purchase a replacement remote control, call (562) 276-4394 (U.S.) or (905) 709-3839 (for dealer referral in Canada).

**Parent topic:** [Solving Problems](#)

---

# Technical Specifications

These sections list the technical specifications of your projector.

[General Projector Specifications](#)

[Projector Light Source Specifications](#)

[Remote Control Specifications](#)

[Projector Dimension Specifications](#)

[Projector Electrical Specifications](#)

[Projector Environmental Specifications](#)

[Projector Safety and Approvals Specifications](#)

[Supported Video Display Formats](#)

[USB Display System Requirements](#)

## General Projector Specifications

<b>Type of display</b>	Poly-silicon TFT active matrix
<b>Resolution</b>	1920 × 1200 pixels (WUXGA)
<b>Lens</b>	F=1.6 Focal length: 4.2 mm
<b>Color reproduction</b>	Full color, up to 1.07 billion colors

<b>Brightness</b>	<p>Normal Light Source Mode:  White light output 4000 lumens (ISO 21118 standard)  Color light output 4000 lumens</p> <p>Quiet or Extended Light Source Mode:  White light output 2800 lumens (ISO 21118 standard)  Custom mode:  White light output 2800 to 4000 lumens (ISO 21118 standard)</p> <p><b>Note:</b> Color brightness (color light output) and white brightness (white light output) will vary depending on usage conditions. Color light output measured in accordance with IDMS 15.4; white light output measured in accordance with ISO 21118.</p>
<b>Contrast ratio</b>	Over 2,500,000:1 with Dynamic Color Mode, Normal Light Source Mode, and Wide Zoom on
<b>Image size</b> (in native aspect ratio)	70 inches (1.78 m) to 130 inches (3.30 m)
<b>Projection distance</b> (in native aspect ratio)	15.9 inches (0.41 m) to 30.7 inches (0.77 m)
<b>Projection methods</b>	Front, rear, wall-mounted, table-mounted, ceiling-mounted
<b>Optical aspect ratio</b> (width-to-height)	16:10
<b>Focus adjustment</b>	Manual
<b>Zoom adjustment</b>	Digital
<b>Zoom ratio</b> (Tele-to-Wide)	1.0 to 1.35
<b>Internal sound system</b>	16 W monaural
<b>Noise level</b>	38 dB (Normal Light Source Mode) 37 dB (Extended Light Source Mode) 27 dB (Quiet Light Source Mode)

<b>Keystone correction angle</b>	± 3°
<b>USB Type B port compatibility</b>	USB 2.0 compliant for USB Display, remote mouse control, firmware update, or copying menu settings
<b>USB Type A port compatibility</b>	Two USB 2.0 compliant ports for USB memory device, Epson document camera, firmware update, or copying menu settings

Parent topic: [Technical Specifications](#)

## Projector Light Source Specifications

<b>Type</b>	Laser Diode
<b>Power consumption</b>	Normal Light Source mode: 448 W Quiet or Extended Light Source mode: 348 W
<b>Light source output power</b>	Up to 108 W
<b>Light source life</b>	Normal or Quiet Light Source mode: Up to about 20000 hours Extended Light Source mode: Up to about 30000 hours

**Note:** Turn off this product when not in use to prolong the life of the projector. Laser life will vary depending upon mode selected, environmental conditions, and usage. Brightness decreases over time.

Parent topic: [Technical Specifications](#)

## Remote Control Specifications

<b>Reception range</b>	19.7 feet (6 m)
<b>Batteries</b>	Two alkaline or manganese AA

Parent topic: [Technical Specifications](#)

## Projector Dimension Specifications

<b>Height</b> (excluding feet)	6.7 inches (172 mm)
<b>Width</b>	19.4 inches (494 mm)
<b>Depth</b>	17.2 inches (437 mm)
<b>Weight</b>	24.3 lb (11.0 kg)

Parent topic: [Technical Specifications](#)

## Projector Electrical Specifications

<b>Rated frequency</b>	50/60 Hz
<b>Power supply</b>	100 to 240 VAC $\pm$ 10% 4.6 to 2.0 A
<b>Power consumption</b> (100 to 120 V)	Operating: Normal Power Consumption mode: 448 W Extended or Quiet Power Consumption mode: 348 W Standby: 0.3 W (Communication Off), 2.0 W (Communication On)
<b>Power consumption</b> (220 to 240 V)	Operating: Normal Power Consumption mode: 423 W Extended or Quiet Power Consumption mode: 332 W Standby: 0.3 W (Communication Off), 2.0 W (Communication On)

Parent topic: [Technical Specifications](#)

## Projector Environmental Specifications

<b>Temperature</b>	Operating - Single projector: 32 to 113 °F (0 to 45 °C)
	Operating - Multiple projectors: 32 to 104 °F (0 to 40 °C)
	Storage: 14 to 140 °F (–10 to 60 °C)
<b>Humidity</b> (relative, non-condensing)	Operating: 20 to 80% Storage: 10 to 90%
<b>Operating altitude</b>	Up to 4921 feet (1500 m) Up to 9842 ft (3000 m) with High Altitude Mode enabled

Parent topic: [Technical Specifications](#)

## Projector Safety and Approvals Specifications

<b>United States</b>	FCC Part 15 Class B UL60950-1 2nd edition (cTUVus Mark)
<b>Canada</b>	ICES-003 Class B CSA C22.2 No. 60950-1-07 (cTUVus Mark)

Parent topic: [Technical Specifications](#)

## Supported Video Display Formats

For best results, your computer's monitor port or video card resolution should be set to display in the projector's native resolution. However, your projector includes Epson's SizeWise chip that supports other computer display resolutions, so your image will be resized to fit automatically.

Your computer's monitor port or video card refresh rate (vertical frequency) must be compatible with the projector. (See your computer or video card manual for details.)

The table here lists the compatible refresh rate and resolution for each compatible video display format.

Display format	Refresh rate (in Hz)	Resolution (in pixels)
<b>Computer signals (analog RGB)</b>		
VGA	60/72/75/85	640 × 480
SVGA	60/72/75/85	800 × 600
XGA	60/70/75/85	1024 × 768
WXGA	60	1280 × 768
	60	1366 × 768
	60/75/85	1280 × 800
WXGA+	60/75/85	1440 × 900
WXGA++	60	1600 × 900
SXGA	70/75/85	1152 × 864
	60/75/85	1280 × 960
	60/75/85	1280 × 1024
SXGA+	60/75	1400 × 1050
WSXGA+*	60	1680 × 1050
UXGA	60	1600 × 1200
WUXGA (Reduced Blanking)	60	1920 × 1200
<b>Composite video</b>		
TV (NTSC)	60	720 × 480
TV (SECAM)	50	720 × 576
TV (PAL)	50/60	720 × 576
<b>Component video</b>		
SDTV (480i/480p)	60	720 × 480
SDTV (576i/576p)	50	720 × 576
HDTV (720p)	50/60	1280 × 720
HDTV (1080i)	50/60	1920 × 1080
<b>HDMI input signals</b>		

Display format	Refresh rate (in Hz)	Resolution (in pixels)
VGA	60	640 × 480
SVGA	60	800 × 600
XGA	60	1024 × 768
WXGA	60	1280 × 800
	60	1366 × 768
WXGA+	60	1440 × 900
WXGA++	60	1600 × 900
WSXGA+	60	1680 × 1050
SXGA	60	1280 × 960
	60	1280 × 1024
SXGA+	60	1400 × 1050
UXGA	60	1600 × 1200
WUXGA (Reduced Blanking)	60	1920 × 1080
SDTV (480i/480p)	60	720 × 480
SDTV (576i/576p)	50	720 × 576
HDTV (720p)	50/60	1280 × 720
HDTV (1080i)	50/60	1920 × 1080
HDTV (1080p)	24/30/50/60	1920 × 1080
<b>MHL input signals</b>		
VGA	60	640 × 480
SDTV (480i/480p)	60	720 × 480
SDTV (576i/576p)	50	720 × 576
HDTV (720p)	50/60	1280 × 720
HDTV (1080i)	50/60	1920 × 1080
HDTV (1080p)	24/30	1920 × 1080

\* **Wide** resolution only



Parent topic: [Technical Specifications](#)

## USB Display System Requirements

Your computer system must meet the system requirements here to use the projector's USB Display software.

Requirement	Windows	Mac
Operating system	Windows Vista Ultimate, Enterprise, Business, Home Premium, and Home Basic (32-bit)	OS X 10.7.x (32- and 64-bit), 10.8.x, 10.9.x, 10.10.x, 10.11.x (64-bit), macOS 10.12.x (64-bit), and macOS 10.13.x (64-bit)
	Windows 7 Ultimate, Enterprise, Professional, and Home Premium (32- and 64-bit); Home Basic and Starter (32-bit)	
	Windows 8.x, Pro, and Enterprise (32- and 64-bit)	
	Windows 10 Home, Pro, and Enterprise (32- and 64-bit)	
CPU	Intel Core2 Duo or faster (Intel Core i3 or faster recommended)	Intel Core2 Duo or faster (Intel Core i5 or faster recommended)
Memory	2GB or more (4GB or more recommended)	
Hard disk space	20MB or more	
Display	Resolution between 640 × 480 and 1920 × 1200, 16-bit color or greater	

**Note:** Operation is not guaranteed for Windows Vista without any installed service packs or with Windows Vista Service Pack 1.

Parent topic: [Technical Specifications](#)

---

## Notices

Check these sections for important notices about your projector.

[Recycling](#)

[Important Safety Information](#)

[Laser Safety Information](#)

[Important Safety Instructions](#)

[List of Safety Symbols \(corresponding to IEC60950-1 A2\)](#)

[FCC Compliance Statement](#)

[Binding Arbitration and Class Waiver](#)

[Trademarks](#)

[Copyright Notice](#)

## Recycling

Epson offers a recycling program for end of life products. Please go to [this site](#) for information on how to return your products for proper disposal.

**Parent topic:** [Notices](#)

## Important Safety Information

**Caution:** Never look into the projector lens when the laser is turned on; the bright light can damage your eyes. Never let children look into the lens when it is on. Never open any cover on the projector, except the filter covers. Dangerous electrical voltages inside the projector can severely injure you. Except as specifically explained in this *User's Guide*, do not attempt to service this product yourself. Refer all servicing to qualified service personnel.

**Warning:** The projector and its accessories come packaged in plastic bags. Keep plastic bags away from small children to avoid any risk of suffocation.

**Parent topic:** [Notices](#)

## Laser Safety Information

This projector is a Class 1 laser product that complies with the IEC/EN60825-1:2014 international standard for lasers. Follow these safety instructions when using the projector.

- If an error occurs in the projector, turn off the power and unplug the projector immediately. Continuing to use the projector could result in an electric shock, fire, or visual impairment. Contact Epson support.
- Do not attempt to disassemble or modify the projector. The projector contains a high-power laser component. Serious injury could result.
- Do not look into the lens during projection. Also, do not look into the lens using optical devices, such as a magnifying glass or telescope. This could cause visual impairment.
- When turning on the projector at a distance using the remote control, make sure no one is looking into the lens.
- Do not allow small children to operate the projector. Children must be accompanied by an adult.
- Do not apply optical devices, such as a magnifying glass or reflector, to the projected image. Using the projector may result in physical harm, fire, or an accident.
- Before using the projector, make sure there is nothing in the area that could reflect the projected image.
- When disposing of the projector, do not disassemble it. Dispose of the projector in accordance with your local or national laws and regulations.

Laser warning labels are attached to the projector in the following locations:

- **Inside**



- Side

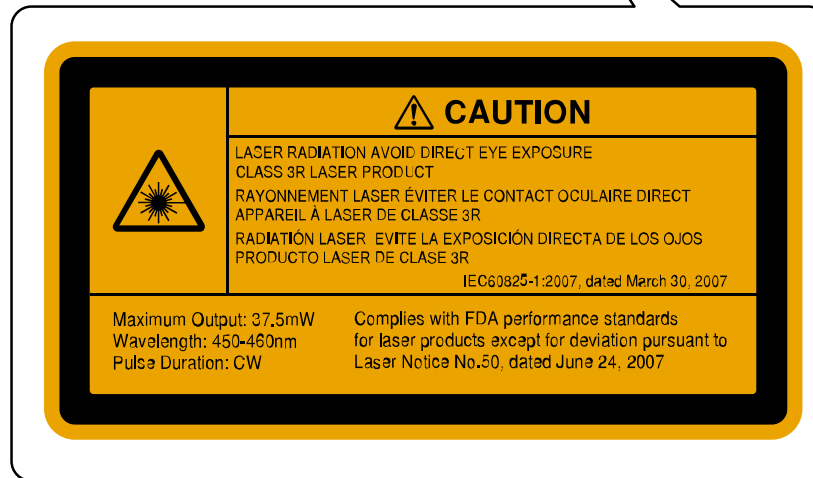
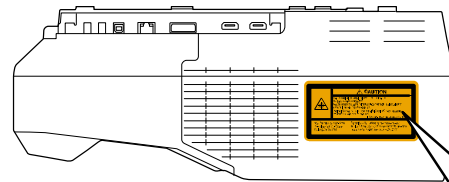
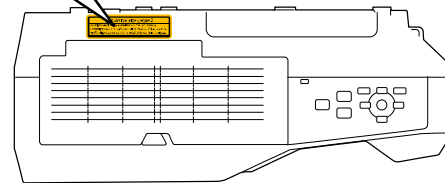

## Important Safety Instructions

Follow these safety instructions when setting up and using the projector:

- Do not look into the lens when the projector is on. The bright light can damage your eyes. Avoid standing in front of the projector so the bright light does not shine into your eyes.
- Do not place your hand or any object near the projection window. The high temperature of this area could cause burns, fire, or other damage.
- Do not place the projector on an unstable cart, stand, or table.
- Do not operate the projector on its side, or while tilted to one side.
- If the projector is mounted on a ceiling or wall, it should be installed by qualified technicians using mounting hardware designed for use with this projector.
- When installing or adjusting a ceiling or wall mount, do not use adhesives to prevent the screws from loosening and do not use oils or lubricants. This may cause the projector case to crack and the projector to fall from its ceiling mount. This could cause serious injury to anyone under the mount and could damage the projector.
- Do not use the projector near water, sources of heat, high-voltage electrical wires, or sources of magnetic fields.
- Use the type of power source indicated on the projector. Use of a different power source may result in fire or electric shock. If you are not sure of the power available, consult your dealer or power company.
- Place the projector near a wall outlet where the plug can be easily unplugged.
- Take the following precautions when handling the plug: Do not hold the plug with wet hands. Do not insert the plug into a dusty outlet. Insert the plug firmly into the outlet. Do not pull the power cord when disconnecting the plug; always be sure to hold the plug when disconnecting it. Do not overload wall outlets, extension cords, or power strips. Failure to comply with these precautions could result in fire or electric shock.
- Do not place the projector where the cord can be walked on. This may result in fraying or damage to the plug.
- Unplug the projector from the wall outlet and allow to cool before cleaning. Use a dry cloth (or, for stubborn dirt or stains, a moist cloth that has been wrung dry) for cleaning. Do not use liquid or aerosol cleaners, any sprays containing flammable gas, or solvents such as alcohol, paint thinner, or benzene.
- Do not block the slots and openings in the projector case. They provide ventilation and prevent the projector from overheating. Do not operate the projector on a sofa, rug, or other soft surface, or set it on top of loose papers. Do not cover the projector with a blanket, curtain, or tablecloth. If you are

setting up the projector near a wall, leave at least 7.9 inches (20 cm) of space between the wall and the projector.

- Do not operate the projector in a closed-in cabinet unless proper ventilation is provided.
- Never allow objects of any kind to enter any openings in the projector. Do not leave objects, especially flammable objects, near the projector. Never spill liquid of any kind into the projector.
- If you are using two or more projectors side-by-side, leave at least 2 feet (60 cm) of space between the projectors to allow for proper ventilation.
- You may need to clean the air filter and vent. A clogged air filter or vent can block ventilation needed to cool the projector. Do not use canned air, or the gases may leave a residue.
- Do not store the projector outdoors for an extended length of time.
- Except as specifically explained in this manual, do not attempt to service this product yourself. Refer all servicing to qualified personnel. Opening or removing covers may expose you to dangerous voltages and other hazards.
- Never open any covers on the projector except as specifically explained in this manual. Never attempt to disassemble or modify the projector. Refer all repairs to qualified service personnel.
- Unplug the projector from the wall outlet and refer servicing to qualified service personnel under the following conditions: if it does not operate normally when you follow the operating instructions, or exhibits a distinct change in performance; if smoke, strange odors, or strange noises come from the projector; if the power cord or plug is damaged or frayed; if liquid or foreign objects get inside the projector, or if it has been exposed to rain or water; if it has been dropped or the housing has been damaged.
- Do not touch the plug during an electrical storm. Otherwise, you may receive an electric shock.
- Unplug the projector when it will not be used for extended periods.
- Do not use the projector where it may be exposed to rain, water, or excessive humidity.
- Do not use or store the projector where it may be exposed to smoke, steam, corrosive gases, excessive dust, vibration, or shock.
- Do not use the projector where flammable or explosive gases may be present.
- Do not use or store the projector or remote control in a hot location, such as near a heater, in direct sunlight, or in a closed vehicle.
- If you use the projector in a country other than where you purchased it, use the correct power cord for that country.
- Do not stand on the projector or place heavy objects on it.
- Do not use the projector outside of the required temperature range below:

32 to 113 °F (0 to 45 °C)

When using multiple projectors at the same time:

32 to 104 °F (0 to 40 °C)

Doing so may cause an unstable display and could lead to projector damage. Do not use or store the projector where it may be exposed to sudden changes in temperature.

- Do not store the projector outside of the required temperature range of 14 to 140 °F (–10 to 60 °C) or in direct sunlight for long periods of time. Doing so may cause damage to the case.
- Do not place anything that can become warped or damaged by heat near the exhaust vents. Do not bring your hands or face close to the vents while projection is in progress. Do not bring your face close to the projector while it is in use.
- Before you move the projector, make sure its power is turned off, the plug is disconnected from the outlet, and all cables are disconnected.
- Do not place the source of an open flame, such as a lit candle, on or near the projector.
- Do not block the lens during projection using a book or any other object. This could damage the projector or cause a fire.
- Do not modify the power cord. Do not place heavy objects on top of the power cord or bend, twist, or pull it excessively. Keep the power cord away from hot electrical appliances.
- Always lower the volume before turning off the projector. Turning on the projector with the volume too high can damage your ears.

[Restriction of Use](#)

**Parent topic:** [Notices](#)

## **Restriction of Use**







When this product is used for applications requiring high reliability/safety such as transportation devices related to aviation, rail, marine, automotive; disaster prevention devices; various safety devices; or functional/precision devices, you should use this product only after giving consideration to including fail-safes and redundancies into your design to maintain safety and total system reliability.

Because this product was not intended for use in applications requiring extremely high reliability/safety such as aerospace equipment, main communication equipment, nuclear power control equipment, or medical equipment related to direct medical care, please make your own judgment on this product's suitability after a full evaluation.







**Parent topic:** [Important Safety Instructions](#)







## List of Safety Symbols (corresponding to IEC60950-1 A2)

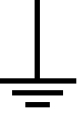

The following table lists the meaning of the safety symbols labeled on the equipment.

No.	Symbol	Approved Standards	Description
1		IEC60417 No.5007	"ON" (power) To indicate connection to the mains.
2		IEC60417 No.5008	"OFF" (power) To indicate disconnection from the mains.
3		IEC60417 No.5009	Stand-by To identify the switch or switch position by means of which part of the equipment is switched on in order to bring it into the stand-by condition.
4		ISO7000 No.0434B, IEC3864-B3.1	Caution To identify general caution when using the product.
5		IEC60417 No.5041	Caution, hot surface To indicate that the marked item can be hot and should not be touched without taking care.
6		IEC60417 No.6042 ISO3864-B3.6	Caution, risk of electric shock To identify equipment that has risk of electric shock.
7		IEC60417 No.5957	For indoor use only To identify electrical equipment designed primarily for indoor use.

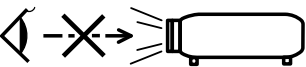

No.	Symbol	Approved Standards	Description
8		IEC60417 No.5926	<p>Polarity of DC power connector</p> <p>To identify the positive and negative connections (the polarity) on a piece of equipment to which a DC power supply may be connected.</p>
9		—	<p>Polarity of DC power connector</p> <p>To identify the positive and negative connections (the polarity) on a piece of equipment to which a DC. power supply may be connected.</p>
10		IEC60417 No.5001B	<p>Battery, general</p> <p>On battery powered equipment. To identify a device for instance a cover for the battery compartment, or the connector terminals.</p>
11		IEC60417 No.5002	<p>Positioning of cell</p> <p>To identify the battery holder itself and to identify the positioning of the cell(s) inside the battery holder.</p>
12		—	<p>Positioning of cell</p> <p>To identify the battery holder itself and to identify the positioning of the cell(s) inside the battery holder.</p>
13		IEC60417 No.5019	<p>Protective earth</p> <p>To identify any terminal which is intended for connection to an external conductor for protection against electric shock in case of a fault, or the terminal of a protective earth electrode.</p>
14		IEC60417 No.5017	<p>Earth</p> <p>To identify an earth (ground) terminal in cases where neither the symbol No.13 is explicitly required.</p>

No.	Symbol	Approved Standards	Description
15		IEC60417 No.5032	Alternating current To indicate on the rating plate that the equipment is suitable for alternating current only; to identify relevant terminals.
16		IEC60417 No.5031	Direct current To indicate on the rating plate that the equipment is suitable for direct current only; to identify relevant terminals.
17		IEC60417 No.5172	Class II equipment To identify equipment meeting the safety requirements specified for Class II equipment according to IEC 61140.
18		ISO 3864	General prohibition To identify actions or operations that are prohibited.
19		ISO 3864	Contact prohibition To indicate injury that could occur due to touching a specific part of the equipment.
20		—	Never look into the optical lens while the projector is on.
21		—	To indicate that the marked item don't place anything on projector.
22		ISO3864 IEC60825-1	Caution, laser radiation To indicate the equipment has a laser radiation part.

No.	Symbol	Approved Standards	Description
23		ISO 3864	Disassembly prohibition To indicate a risk of injury, such as electric shock, if the equipment is disassembled.
24		IEC60417 No. 5266	Standby, partial standby To indicate that part of the equipment is in the ready status.
25		ISO3864 IEC60417 No. 5057	Caution, movable parts To indicate that you must keep away from movable parts according to protection standards.

Parent topic: [Notices](#)

## FCC Compliance Statement

### For United States Users

This equipment has been tested and found to comply with the limits for a Class B digital device, pursuant to Part 15 of the FCC Rules. These limits are designed to provide reasonable protection against harmful interference in a residential installation. This equipment generates, uses, and can radiate radio frequency energy and, if not installed and used in accordance with the instructions, may cause harmful interference to radio communications. However, there is no guarantee that interference will not occur in a particular installation. If this equipment does cause interference to radio and television reception, which can be determined by turning the equipment off and on, the user is encouraged to try to correct the interference by one or more of the following measures:

- Reorient or relocate the receiving antenna.
- Increase the separation between the equipment and receiver.
- Connect the equipment into an outlet on a circuit different from that to which the receiver is connected.
- Consult the dealer or an experienced radio/TV technician for help.

### WARNING

The connection of a non-shielded equipment interface cable to this equipment will invalidate the FCC Certification or Declaration of this device and may cause interference levels which exceed the limits

established by the FCC for this equipment. It is the responsibility of the user to obtain and use a shielded equipment interface cable with this device. If this equipment has more than one interface connector, do not leave cables connected to unused interfaces. Changes or modifications not expressly approved by the manufacturer could void the user's authority to operate the equipment.

### **For Canadian Users**

CAN ICES-3(B)/NMB-3(B)

Parent topic: [Notices](#)

## **Binding Arbitration and Class Waiver**

### **1. DISPUTES, BINDING INDIVIDUAL ARBITRATION, AND WAIVER OF CLASS ACTIONS AND CLASS ARBITRATIONS**

**1.1 Disputes.** The terms of this Section 1 shall apply to all Disputes between you and Epson. The term "Dispute" is meant to have the broadest meaning permissible under law and includes any dispute, claim, controversy or action between you and Epson arising out of or relating to this Agreement, Epson branded products (hardware and including any related software), or other transaction involving you and Epson, whether in contract, warranty, misrepresentation, fraud, tort, intentional tort, statute, regulation, ordinance, or any other legal or equitable basis. "DISPUTE" DOES NOT INCLUDE IP CLAIMS, or more specifically, a claim or cause of action for (a) trademark infringement or dilution, (b) patent infringement, (c) copyright infringement or misuse, or (d) trade secret misappropriation (an "IP Claim"). You and Epson also agree, notwithstanding Section 1.6, that a court, not an arbitrator, may decide if a claim or cause of action is for an IP Claim.

**1.2 Binding Arbitration.** You and Epson agree that all Disputes shall be resolved by binding arbitration according to this Agreement. **ARBITRATION MEANS THAT YOU WAIVE YOUR RIGHT TO A JUDGE OR JURY IN A COURT PROCEEDING AND YOUR GROUNDS FOR APPEAL ARE LIMITED.**

Pursuant to this Agreement, binding arbitration shall be administered by JAMS, a nationally recognized arbitration authority, pursuant to its code of procedures then in effect for consumer related disputes, but excluding any rules that permit joinder or class actions in arbitration (for more detail on procedure, see Section 1.6 below). You and Epson understand and agree that (a) the Federal Arbitration Act (9 U.S.C. §1, et seq.) governs the interpretation and enforcement of this Section 1, (b) this Agreement memorializes a transaction in interstate commerce, and (c) this Section 1 shall survive termination of this Agreement.

**1.3 Pre-Arbitration Steps and Notice.** Before submitting a claim for arbitration, you and Epson agree to try, for sixty (60) days, to resolve any Dispute informally. If Epson and you do not reach an agreement to resolve the Dispute within the sixty (60) days, you or Epson may commence an arbitration. Notice to Epson must be addressed to: Epson America, Inc., ATTN: Legal Department, 3840 Kilroy Airport Way, Long Beach, CA 90806 (the "Epson Address"). The Dispute Notice to you will be sent to the most recent

address Epson has in its records for you. For this reason, it is important to notify us if your address changes by emailing us at [EAILEgal@ea.epson.com](mailto:EAILEgal@ea.epson.com) or writing us at the Epson Address above. Notice of the Dispute shall include the sender's name, address and contact information, the facts giving rise to the Dispute, and the relief requested (the "Dispute Notice"). Following receipt of the Dispute Notice, Epson and you agree to act in good faith to resolve the Dispute before commencing arbitration.

**1.4 Small Claims Court.** Notwithstanding the foregoing, you may bring an individual action in the small claims court of your state or municipality if the action is within that court's jurisdiction and is pending only in that court.

**1.5 WAIVER OF CLASS ACTIONS AND CLASS ARBITRATIONS. YOU AND EPSON AGREE THAT EACH PARTY MAY BRING DISPUTES AGAINST THE OTHER PARTY ONLY IN AN INDIVIDUAL CAPACITY, AND NOT AS A PLAINTIFF OR CLASS MEMBER IN ANY CLASS OR REPRESENTATIVE PROCEEDING, INCLUDING WITHOUT LIMITATION FEDERAL OR STATE CLASS ACTIONS, OR CLASS ARBITRATIONS. CLASS ACTION LAWSUITS, CLASS-WIDE ARBITRATIONS, PRIVATE ATTORNEY-GENERAL ACTIONS, AND ANY OTHER PROCEEDING WHERE SOMEONE ACTS IN A REPRESENTATIVE CAPACITY ARE NOT ALLOWED. ACCORDINGLY, UNDER THE ARBITRATION PROCEDURES OUTLINED IN THIS SECTION, AN ARBITRATOR SHALL NOT COMBINE OR CONSOLIDATE MORE THAN ONE PARTY'S CLAIMS WITHOUT THE WRITTEN CONSENT OF ALL AFFECTED PARTIES TO AN ARBITRATION PROCEEDING.**

**1.6 Arbitration Procedure.** If you or Epson commences arbitration, the arbitration shall be governed by the rules of JAMS that are in effect when the arbitration is filed, excluding any rules that permit arbitration on a class or representative basis (the "JAMS Rules"), available at <http://www.jamsadr.com> or by calling 1-800-352-5267, and under the rules set forth in this Agreement. All Disputes shall be resolved by a single neutral arbitrator, and both parties shall have a reasonable opportunity to participate in the selection of the arbitrator. The arbitrator is bound by the terms of this Agreement. The arbitrator, and not any federal, state or local court or agency, shall have exclusive authority to resolve all disputes arising out of or relating to the interpretation, applicability, enforceability or formation of this Agreement, including any claim that all or any part of this Agreement is void or voidable. Notwithstanding this broad delegation of authority to the arbitrator, a court may determine the limited question of whether a claim or cause of action is for an IP Claim, which is excluded from the definition of "Disputes" in Section 1.1 above. The arbitrator shall be empowered to grant whatever relief would be available in a court under law or in equity. The arbitrator may award you the same damages as a court could, and may award declaratory or injunctive relief only in favor of the individual party seeking relief and only to the extent necessary to provide relief warranted by that party's individual claim. In some instances, the costs of arbitration can exceed the costs of litigation and the right to discovery may be more limited in arbitration than in court. The arbitrator's award is binding and may be entered as a judgment in any court of competent jurisdiction.

You may choose to engage in arbitration hearings by telephone. Arbitration hearings not conducted by telephone shall take place in a location reasonably accessible from your primary residence, or in Orange County, California, at your option.

a) Initiation of Arbitration Proceeding. If either you or Epson decides to arbitrate a Dispute, both parties agree to the following procedure:

(i) Write a Demand for Arbitration. The demand must include a description of the Dispute and the amount of damages sought to be recovered. You can find a copy of a Demand for Arbitration at <http://www.jamsadr.com> ("Demand for Arbitration").

(ii) Send three copies of the Demand for Arbitration, plus the appropriate filing fee, to: JAMS, 500 North State College Blvd., Suite 600 Orange, CA 92868, U.S.A.

(iii) Send one copy of the Demand for Arbitration to the other party (same address as the Dispute Notice), or as otherwise agreed by the parties.

b) Hearing Format. During the arbitration, the amount of any settlement offer made shall not be disclosed to the arbitrator until after the arbitrator determines the amount, if any, to which you or Epson is entitled. The discovery or exchange of non-privileged information relevant to the Dispute may be allowed during the arbitration.

c) Arbitration Fees. Epson shall pay, or (if applicable) reimburse you for, all JAMS filings and arbitrator fees for any arbitration commenced (by you or Epson) pursuant to provisions of this Agreement.

d) Award in Your Favor. For Disputes in which you or Epson seeks \$75,000 or less in damages exclusive of attorney's fees and costs, if the arbitrator's decision results in an award to you in an amount greater than Epson's last written offer, if any, to settle the Dispute, Epson will: (i) pay you \$1,000 or the amount of the award, whichever is greater; (ii) pay you twice the amount of your reasonable attorney's fees, if any; and (iii) reimburse you for any expenses (including expert witness fees and costs) that your attorney reasonably accrues for investigating, preparing, and pursuing the Dispute in arbitration. Except as agreed upon by you and Epson in writing, the arbitrator shall determine the amount of fees, costs, and expenses to be paid by Epson pursuant to this Section 1.6d).

e) Attorney's Fees. Epson will not seek its attorney's fees and expenses for any arbitration commenced involving a Dispute under this Agreement. Your right to attorney's fees and expenses under Section 1.6d) above does not limit your rights to attorney's fees and expenses under applicable law; notwithstanding the foregoing, the arbitrator may not award duplicative awards of attorney's fees and expenses.

**1.7 Opt-out. You may elect to opt-out (exclude yourself) from the final, binding, individual arbitration procedure and waiver of class and representative proceedings specified in this Agreement by sending a written letter to the Epson Address within thirty (30) days of your assent to this Agreement (including without limitation the purchase, download, installation of the Software or other applicable use of Epson Hardware, products and services) that specifies (i) your name, (ii) your mailing address, and (iii) your request to be excluded from the final, binding**

**individual arbitration procedure and waiver of class and representative proceedings specified in this Section 1. In the event that you opt-out consistent with the procedure set forth above, all other terms shall continue to apply, including the requirement to provide notice prior to litigation.**

**1.8 Amendments to Section 1.** Notwithstanding any provision in this Agreement to the contrary, you and Epson agree that if Epson makes any future amendments to the dispute resolution procedure and class action waiver provisions (other than a change to Epson's address) in this Agreement, Epson will obtain your affirmative assent to the applicable amendment. If you do not affirmatively assent to the applicable amendment, you are agreeing that you will arbitrate any Dispute between the parties in accordance with the language of this Section 1 (or resolve disputes as provided for in Section 1.7, if you timely elected to opt-out when you first assented to this Agreement).

**1.9 Severability.** If any provision in this Section 1 is found to be unenforceable, that provision shall be severed with the remainder of this Agreement remaining in full force and effect. **The foregoing shall not apply to the prohibition against class or representative actions as provided in Section 1.5. This means that if Section 1.5 is found to be unenforceable, the entire Section 1 (but only Section 1) shall be null and void.**

Parent topic: [Notices](#)

## Trademarks

EPSON®, EasyMP®, Instant Off®, PowerLite®, and Quick Corner® are registered trademarks, and EPSON Exceed Your Vision is a registered logomark of Seiko Epson Corporation.

PrivateLine® is a registered trademark; SizeWise™ is a trademark; and Epson Store<sup>SM</sup> and Extra Care<sup>SM</sup> are service marks of Epson America, Inc.

Mac and OS X are trademarks of Apple Inc., registered in the U.S. and other countries.

Google® is a registered trademark and Android™, Chromebook™, and Google Play™ are trademarks of Google Inc.

HDMI and High-Definition Multimedia Interface are the trademarks or registered trademarks of HDMI Licensing LLC.  HIGH DEFINITION MULTIMEDIA INTERFACE

General Notice: Other product names used herein are for identification purposes only and may be trademarks of their respective owners. Epson disclaims any and all rights in those marks.

**EPSON®**  
EXCEED YOUR VISION

Parent topic: [Notices](#)

## Copyright Notice

All rights reserved. No part of this publication may be reproduced, stored in a retrieval system, or transmitted in any form or by any means, electronic, mechanical, photocopying, recording, or otherwise, without the prior written permission of Seiko Epson Corporation. The information contained herein is designed only for use with this Epson product. Epson is not responsible for any use of this information as applied to other products.

Neither Seiko Epson Corporation nor its affiliates shall be liable to the purchaser of this product or third parties for damages, losses, costs, or expenses incurred by purchaser or third parties as a result of: accident, misuse, or abuse of this product or unauthorized modifications, repairs, or alterations to this product, or (excluding the U.S.) failure to strictly comply with Seiko Epson Corporation's operating and maintenance instructions.

Seiko Epson Corporation shall not be liable for any damages or problems arising from the use of any options or any consumable products other than those designated as Original Epson Products or Epson Approved Products by Seiko Epson Corporation.

This information is subject to change without notice.

[A Note Concerning Responsible Use of Copyrighted Materials](#)

[Copyright Attribution](#)

**Parent topic:** [Notices](#)

## A Note Concerning Responsible Use of Copyrighted Materials

Epson encourages each user to be responsible and respectful of the copyright laws when using any Epson product. While some countries' laws permit limited copying or reuse of copyrighted material in certain circumstances, those circumstances may not be as broad as some people assume. Contact your legal advisor for any questions regarding copyright law.

**Parent topic:** [Copyright Notice](#)

## Copyright Attribution

© 2017 Epson America, Inc.

10/17

CPD-54290

**Parent topic:** [Copyright Notice](#)