



42-inch Class FULL HD LCD Display TH-42LF80W

Product specification (design and specification subject to change without notice)

■ DISPLAY PANEL

Screen Size (Diagonal)	42-inch (1064 mm)
Panel type	IPS / Edge-LED
Aspect ratio	16:9
Effective Display Area (W x H)	927 x 521 mm
Number of pixels (H x V)	1920 x 1080 pixels
Brightness	700 cd/m ² (Typ)
Contrast Ratio	1300:1
Dynamic Contrast	50000:1
Response Time	8 ms (G to G)
Viewing Angle (Horizontal / Vertical)	178° / 178° (CR ≥ 10)
Panel Surface Treatment	Anti glare (Haze 10%)
Panel Life Time*1	approx. 60000 hours (typ)

*1 When the panel lifetime is at 50% of the brightness under the condition of 25 degrees Celsius (+/- 2 degrees Celsius).

■ CONNECTION TERMINAL

HDMI IN	HDMI Type A Connector x 2	Linear PCM (Sampling frequency : 48 kHz/44.1 kHz/32 kHz)
COMPONENT/RGB IN	BNC x 1 set	Y/G : BNC Contact Plug with sync 1.0 Vp-p (75 Ω) P _B /C _B /B : BNC Contact Plug without sync 0.7 Vp-p (75 Ω) P _R /C _R /R : BNC Contact Plug without sync 0.7 Vp-p (75 Ω)
AUDIO IN	Stereo Mini Jack (M3) x 1 (Shared with VIDEO IN)	0.5 Vrms
VIDEO IN	BNC x 1 (Shared with COMPONENT/RGB Y/G)	1.0 Vp-p (75 Ω) 0.5 Vrms
AUDIO IN	Stereo Mini Jack (M3) x 1 (Shared with COMPONENT IN)	0.5 Vrms
DVI-D IN	DVI-D 24-pin x 1	Compliance with DVI Revision 1.0 Compatible with HDCP 1.1
AUDIO IN	Stereo Mini Jack (M3) x 1 (Shared with PC IN)	0.5 Vrms
DVI-D OUT	DVI-D 24-pin x 1	Compliance with DVI Revision 1.0 Compatible with HDCP 1.1
PC IN	Mini D-Sub 15-pin x 1 (Female)	Y/G : with sync 1.0 Vp-p (75 Ω) : without sync 0.7 Vp-p (75 Ω) P _B /C _B /B : without sync 0.7 Vp-p (75 Ω) P _R /C _R /R : without sync 0.7 Vp-p (75 Ω) HD/VD : 1.0 - 5.0 Vp-p (high impedance)
AUDIO IN	Stereo Mini Jack (M3) x 1 (Shared with DVI-D IN)	0.5 Vrms
SERIAL IN/OUT	D-sub 9pin x 1 / x 1, RS-232C Compatible	
LAN/DIGITAL LINK IN	RJ45 x 1 100BASE-TX, Compatible with PLink	
IR TRANSMITTER IN / OUT	Stereo Mini Jack (M3) x 1 / x 1	
AUDIO OUT	Stereo Mini Jack (M3) x 1 Variable (-∞ - 0 dB) (1 kHz 0 dB Input, 10 k Ω Load)	0.5 Vrms
USB	USB 2.0 Type A connector x 1 DC 5 V/1A (USB3.0 Incompatible)	

*Due to the construction of terminal, some types of connecting cable or USB memory device cannot be used.
Be sure to make confirmation with reference to the detailed drawing of terminal in page 4.

■ SPEAKER

Built in Speaker	20 W [10 W +10 W]
------------------	-------------------

■ ELECTRICAL

Power Requirements	220 - 240 V AC 50 / 60 Hz
Power Consumption	155 W
On Mode Average Power Consumption*	110 W
Power Off Condition	approx. 0.3 W
Stand-by Condition	approx. 0.5 W
Apparent power	165 VA

*Based on IEC 62087 Ed.2 measurement method

■ MECHANICAL

Dimensions (W x H x D)	947 x 541 x 72 mm
Dimensions (W x H x D) (Excluding handle part)	947 x 541 x 57 mm
Weight	approx. 15.3 kg
Bezel Color	Black
Bezel Width	T/R/L/B : 6.3 mm
Carton Dimensions (W x H x D)	1123 x 743 x 203 mm
Gross Weight	approx. 20.0 kg
Cabinet Material / Color	Metal / Black
Pitch for Wall-Hanging	VESA Compliant 200 x 200 mm (Installed by: M6 screws / Screw hole depth 10 mm)

■ INSTALLATION REQUIREMENT

Orientation	Landscape / Portrait
Tilting Angle	0 - 45 degrees forward / backward with landscape / portrait setting

*Please contact your sales representative with regard to the tilt angle before installation.

■ ENVIRONMENTAL

Operating Environment	Temperature	: 0 °C to 40 °C *1 ; 0 °C to 35 °C *2
	Humidity	: 20% to 80% (No condensation)
	Altitude	: 0 to 2800 m
Storage Environment	Temperature	: -20 °C to 60 °C
	Humidity	: 20% to 80% (No condensation)

*1 : for up to 1400 m altitude *2 : for between 1400 m and 2800 m altitude
Depending on the temperature or humidity conditions, uneven brightness may be observed. This is not a malfunction.
• This unevenness will disappear while applying current continuously. If not, consult the distributor.

MAIN FEATURE

USB Media Player	Yes
Fail back & Fail over	Yes
Data Cloning	Yes
Early Warning Software compatible	Yes
Multi Monitoring & Control Software compatible	Yes
Operating Time	24h / 7d
Digital Zoom	Yes
Multi Display	Yes
Power ON Screen Delay	Yes
1:1 Pixel mode	Yes
Auto setup	Yes
Screen Saver	Yes
HDMI Power Management	Yes
DIGITAL LINK Power Management	Yes
PC Power Management	Yes
DVI-D Power Management	Yes
Input Lock	Yes
Button Lock	Yes
Remote-control User Level	Yes
Input Search	Yes

In case of running for a long time, the moving image is recommended to be displayed. If you display a still picture for an extended period, the image retention might remain on the screen. However, image retention can gradually disappear by displaying a moving images.

STANDARD (CERTIFICATIONS)

SAFETY REGULATIONS	IEC60950-1
RADIATION REGULATIONS	EN55022:2010 Class A EN55024:2010 EN61000-3-2:2006+A1:2009+A2:2009 class D EN61000-3-3:2013 AS/NZS CISPR22:2009

REMOTE CONTROL TRANSMITTER

Power Requirements	DC 3 V (2 x AAA Size batteries)
Operating distance	approx. 7 m*
Weight	approx. 63 g including batteries
Dimensions (W x H x D)	44 x 105 x 20.5 mm

*When operated directly in front of receptor.

INCLUDED ACCESSORIES

- AC cord (2.0 m)
- Remote Control
- Batteries (AAA size) x 2
- Clamper x 3
- Operating instruction book

OPTIONAL ACCESSORIES

Pedestal Stand	TY-ST43PE8
----------------	------------

DIMENSIONS

Cautions: This drawing is not a scale
Units : mm

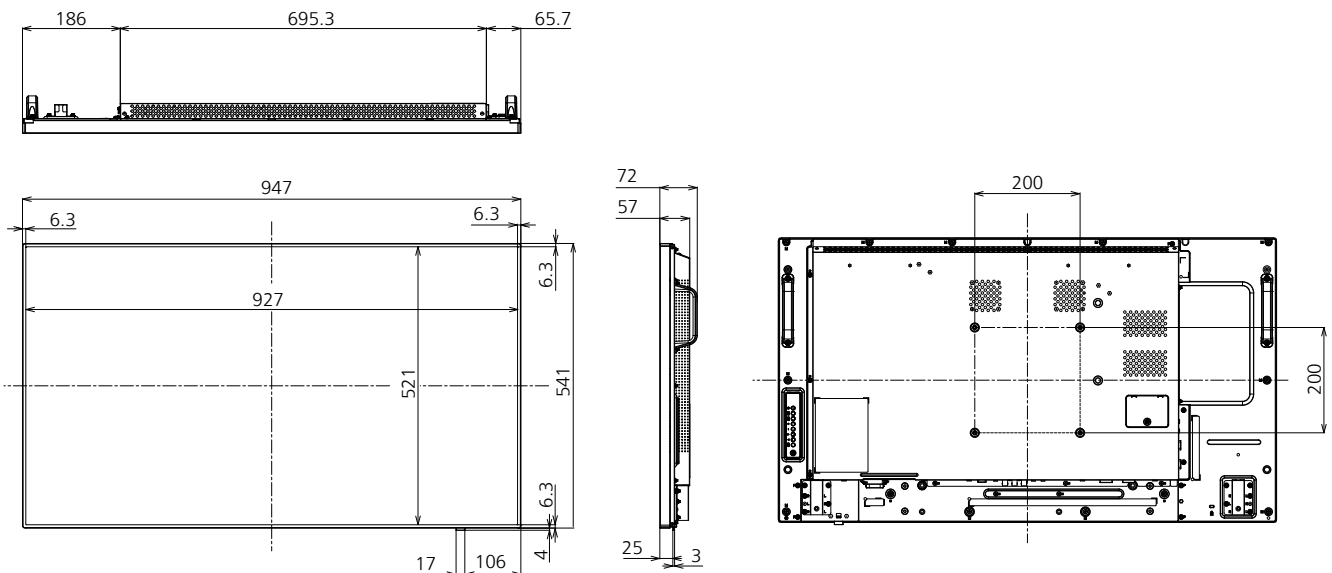

CONNECTION TERMINAL

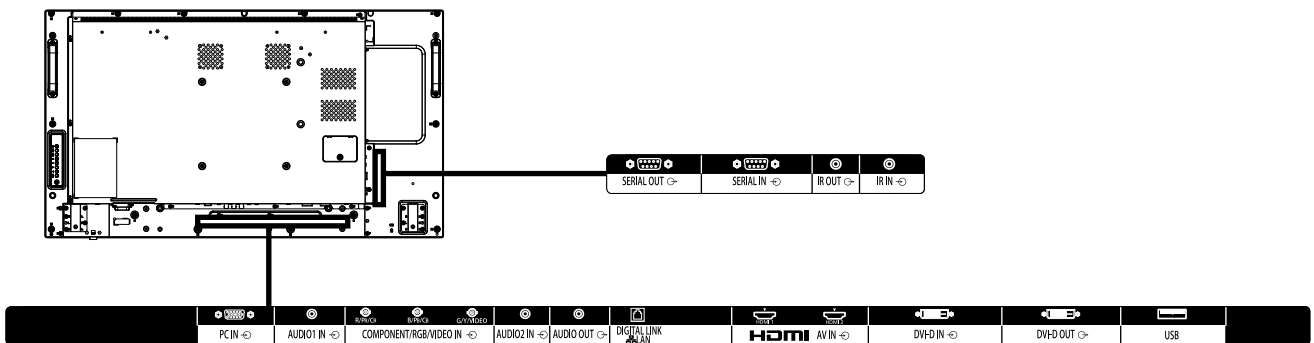

* Specifications and appearance are subject to change without notice.

List of correspondence signals

V : VIDEO
R : D-sub RGB
Y : YCbCr/YpPbPr

D : DVI-D
H : HDMI
DL : DIGITAL LINK

The picture signal which can indicate a this machine is as it is the following table.

Correspondence signal	Resolution (dot)	Scan rate		Dot clock rate (MHz)	Input format	DIGITAL LINK
		Horizontal(kHz)	Vertical(Hz)			
NTSC/NTSC4.43/ PAL-M/PAL60	720 x 480i	15.73	59.94	-	V	
PAL/PAL-N/SECAM	720 x 576i	15.63	50.00	-	V	
525i (480i)	720 x 480	15.73	59.94	13.50	R/Y	
625i (576i)	720 x 576i	15.63	50.00	13.50	R/Y	
525i (480i)	720 (1440) x 480 ^{*2}	15.73	59.94	27.00	D/H	DL
625i (576i)	720 (1440) x 576i ^{*2}	15.63	50.00	27.00	D/H	DL
525p (480p)	720 x 483	31.47	59.94	27.00	R/Y/D/H	DL
625p (576p)	720 x 576	31.25	50.00	27.00	R/Y/D/H	DL
750 (720) /60p	1280 x 720	45.00	60.00	74.25	R/Y/D/H	DL
750 (720) /50p	1280 x 720	37.50	50.00	74.25	R/Y/D/H	DL
1125 (1080) /60i ^{*1}	1920 x 1080i	33.75	60.00	74.25	R/Y/D/H	DL
1125 (1080) /50i	1920 x 1080i	28.13	50.00	74.25	R/Y/D/H	DL
1125 (1080) /24p	1920 x 1080	27.00	24.00	74.25	R/Y/D/H	DL
1125 (1080) /24PsF	1920 x 1080i	27.00	48.00	74.25	R/Y	
1125 (1080) /25p	1920 x 1080	28.13	25.00	74.25	R/Y/D/H	DL
1125 (1080) /30p	1920 x 1080	33.75	30.00	74.25	R/Y/D/H	DL
1125 (1080) /60p	1920 x 1080	67.50	60.00	148.50	R/Y/D/H	DL
1125 (1080) /50p	1920 x 1080	56.25	50.00	148.50	R/Y/D/H	DL
VESA400	640 x 400	31.47	70.09	25.18	R/Y/D/H	DL
	640 x 400	31.50	85.08	31.50	R/Y/D/H	DL
VGA	640 x 480	31.47	59.94	25.18	R/Y/D/H	DL
	640 x 480	35.00	66.67	30.24	R/Y/D/H	DL
	640 x 480	37.86	72.81	31.50	R/Y/D/H	DL
	640 x 480	37.50	75.00	31.50	R/Y/D/H	DL
	640 x 480	43.27	85.01	36.00	R/Y/D/H	DL
SVGA	800 x 600	35.16	56.25	36.00	R/Y/D/H	DL
	800 x 600	37.88	60.32	40.00	R/Y/D/H	DL
	800 x 600	48.08	72.19	50.00	R/Y/D/H	DL
	800 x 600	46.88	75.00	49.50	R/Y/D/H	DL
MAC16	832 x 624	49.72	74.55	57.28	R/Y/D/H	DL
	852 x 480	31.47	59.94	34.24	D/H	DL
XGA	1024 x 768	39.55	50.00	51.89	D/H	DL
	1024 x 768	48.36	60.00	65.00	R/Y/D/H	DL
	1024 x 768	56.48	70.07	75.00	R/Y/D/H	DL
	1024 x 768	60.02	75.03	78.75	R/Y/D/H	DL
	1024 x 768	65.55	81.63	86.00	R/Y/D/H	DL
	1024 x 768	68.68	85.00	94.50	R/Y/D/H	DL
WSVGA	1066 x 600	37.64	59.94	53.00	D/H	DL
MXGA	1152 x 864	53.70	60.00	81.62	D/H	DL
	1152 x 864	63.99	70.02	94.20	R/Y/D/H	DL
	1152 x 864	67.50	75.00	108.00	R/Y/D/H	DL
	1152 x 864	77.09	85.00	119.65	R/Y/D/H	DL
MAC21	1152 x 870	68.68	75.06	100.00	R/Y/D/H	DL
1280 x 720	1280 x 720	44.76	60.00	74.48	R/Y/D/H	DL
	1280 x 768	39.55	49.94	65.18	R/Y/D/H	DL
	1280 x 768	47.70	60.00	80.14	R/Y/D/H	DL
1280 x 768	1280 x 768	47.78	59.87	79.50	R/Y/D/H	DL
	1280 x 800	41.20	50.00	68.56	R/Y/D/H	DL
	1280 x 800	49.31	59.91	71.00	R/Y/D/H	DL
1280 x 800	1280 x 800	49.70	59.81	83.50	R/Y/D/H	DL
	1280 x 960	60.00	60.00	108.00	R/Y/D/H	DL
	1280 x 960	85.94	85.00	148.50	R/Y	
SXGA	1280 x 1024	63.98	60.02	108.00	R/Y/D/H	DL
	1280 x 1024	79.98	75.02	135.00	R/Y/D/H	DL
	1280 x 1024	91.15	85.02	157.50	R/Y/D/H	DL
1360 x 768	1360 x 768	47.71	60.02	85.50	D/H	DL
	1360 x 768	47.70	60.00	84.72	D/H	DL
	1360 x 768	47.72	59.80	84.75	D/H	DL
1366 x 768	1366 x 768	39.55	50.00	69.92	D/H	DL
	1366 x 768	48.39	60.03	86.71	R/Y/D/H	DL
	1366 x 768	48.00	60.00	72.00	R/Y/D/H	DL
	1366 x 768	39.56	49.89	69.00	R/Y/D/H	DL
	1366 x 768	47.71	59.79	85.50	R/Y/D/H	DL
SXGA+	1400 x 1050	65.22	60.00	122.61	D/H	DL
	1400 x 1050	82.20	75.00	155.85	R/Y/D/H	DL
WXGA+	1440 x 900	55.47	59.90	88.75	R/Y/D/H	DL
	1440 x 900	55.92	60.00	106.47	R/Y/D/H	DL
1600 x 900	1600 x 900	46.30	50.00	97.05	D/H	DL
	1600 x 900	60.00	60.00	108.00	D/H	DL
	1600 x 900	55.99	59.95	118.25	D/H	DL
	1600 x 900	55.92	60.00	119.00	D/H	DL
WSXGA+	1680 x 1050	65.29	59.95	146.25	R/Y/D/H	DL
UXGA	1600 x 1200 ^{*3}	75.00	60.00	162.00	R/Y/D/H	DL
1920 x 1080	1920 x 1080 ^{*4}	66.59	59.93	138.50	R/Y/D/H	DL
	1920 x 1080	67.50	60.00	148.50	R/Y/D/H	DL
WUXGA	1920 x 1200 ^{*3}	74.04	59.95	154.00	R/Y/D/H	DL

● The signal format distinguished automatically will be sometimes indication different from an actual input signal.

*1: When 1125 (1035) /60i signal is input, it is displayed as 1125 (1080) /60i signal. *3: Displayed with image elements thinned out in the image processing circuit.

*2: Pixel-Repetition signal (dot clock frequency 27.0 MHz) only

*4: Based on VESA CVT-RB (Reduced Blanking) standard

● Drawing of terminals

View from back

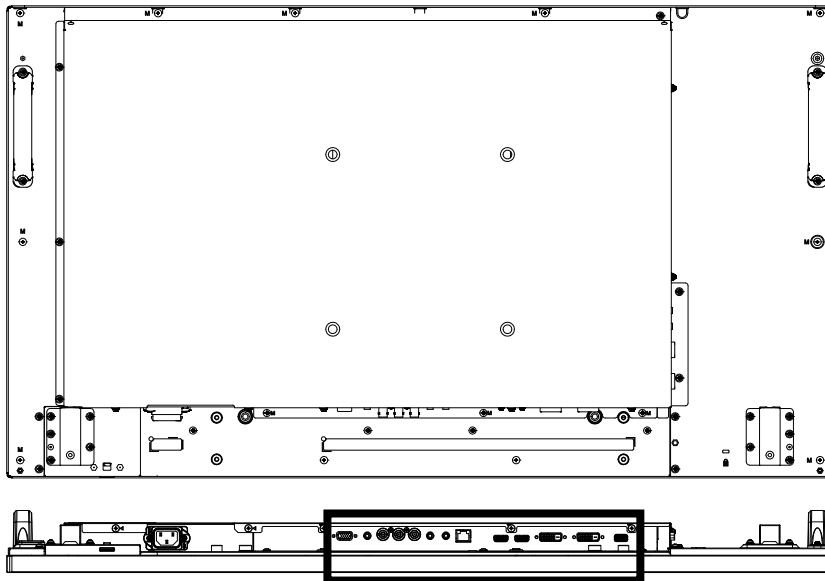

Magnified figure of terminal b

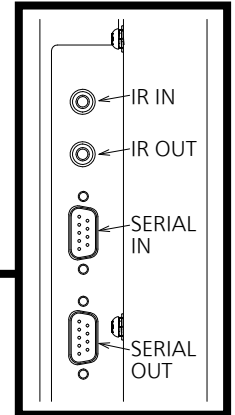

Magnified figure of terminal a

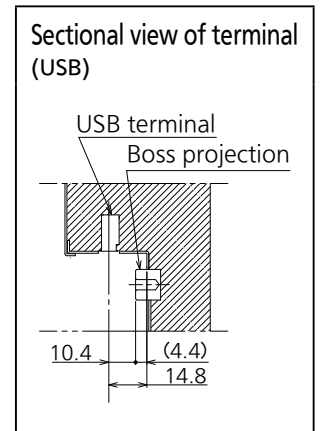
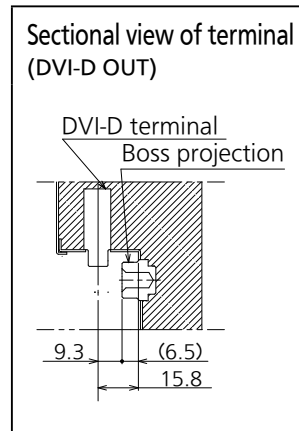
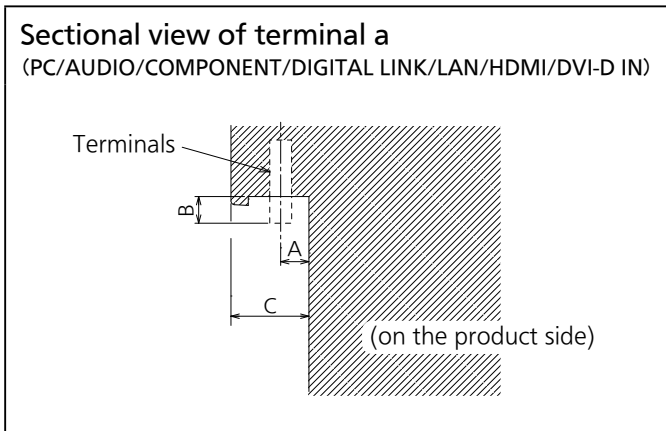
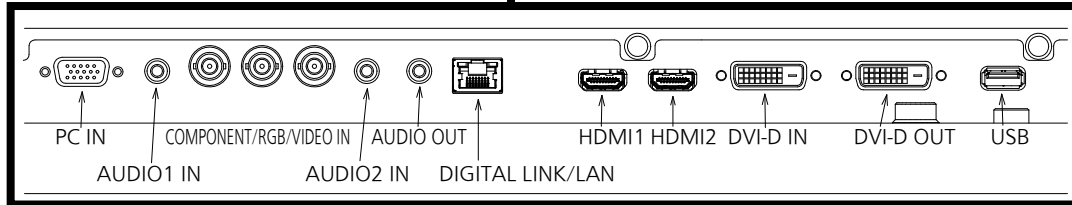

Terminal a
42LF8/80 Terminal (Bottom)

Units : mm

	PC	AUDIO	COMPONENT	DIGITAL LINK/LAN	HDMI	DVI-D IN
A	17.1	17.3	18.9	15.2	14.2	15.8
B	4.3	1.7	10.8			4.7
C	32					

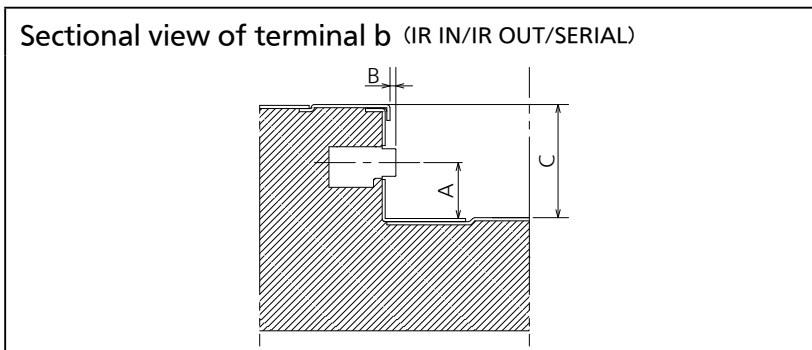

Terminal b
42LF8/80 Terminal (Side)

Units : mm

	IR IN/OUT	SERIAL
A		14.2
B	1.5	4
C		28.7

*Due to the construction of terminal, some types of connecting cable or USB memory device cannot be used.
Be sure to use connecting cable or USB memory device after confirmation in this drawing.