

# USER MANUAL

# *ProLite*

## LCD Monitor

ENGLISH

### *ProLite TF6537UHSC*

Thank you very much for choosing the iiyama LCD monitor.

We recommend that you take a few minutes to read this comprehensive manual carefully before installing and switching on the monitor. Please keep this manual in a safe place for your future reference.

## CE MARKING DECLARATION OF CONFORMITY

This LCD monitor complies with the requirements of the EC/EU Directive 2014/30/EU "EMC Directive", 2014/35/EU "Low Voltage Directive", 2009/125/EC "ErP Directive" and 2011/65/EU "RoHS Directive".

### Warning

This is a class A product. In a domestic environment this product may cause radio interference in which case the user may be required to take adequate measures.

IYAMA CORPORATION: Wijkemeerstraat 8, 2131 HA Hoofddorp, The Netherlands

Model No. : PL6537



We recommend recycling of used product. Please contact your dealer or iiyama service center. Recycle information is obtained via the Internet, using the address: <http://www.iiyama.com>

You can access the Web page of different countries from there.

- We reserve the right to change specifications without notice.
- All trademarks used in this user manual are the property of their respective owners.

# TABLE OF CONTENTS

FOR YOUR SAFETY.....	1
SAFETY PRECAUTIONS.....	1
SPECIAL NOTES ON LCD MONITORS .....	3
CUSTOMER SERVICE .....	5
CLEANING .....	5
BEFORE YOU OPERATE THE MONITOR.....	6
FEATURES.....	6
CHECKING THE CONTENTS OF THE PACKAGE .....	6
UNPACKING .....	7
SPECIAL NOTES ON.....	7
CONTROLS AND CONNECTORS : MONITOR.....	8
INSTALLATION .....	9
CONTROLS AND CONNECTORS :	
REMOTE CONTROL (For maintenance).....	11
PREPARING THE REMOTE CONTROL.....	12
BASIC OPERATION.....	13
CONNECTING YOUR MONITOR.....	16
COMPUTER SETTING .....	17
OPERATING THE MONITOR.....	18
ADJUSTMENT MENU CONTENTS.....	20
SCREEN ADJUSTMENTS .....	30
POWER MANAGEMENT FEATURE.....	33
TROUBLE SHOOTING .....	34
RECYCLING INFORMATION.....	35
APPENDIX .....	36
SPECIFICATIONS.....	36
DIMENSIONS.....	37
COMPLIANT TIMING .....	38

# FOR YOUR SAFETY

## SAFETY PRECAUTIONS

### WARNING

#### **STOP OPERATING THE MONITOR WHEN YOU SENSE TROUBLE**

If you notice any abnormal phenomena such as smoke, strange sounds or fumes, unplug the monitor and contact your dealer or iiyama service center immediately. Further use may be dangerous and can cause fire or electric shock.

#### **NEVER REMOVE THE CABINET**

High voltage circuits are inside the monitor. Removing the cabinet may expose you to the danger of fire or electric shock.

#### **DO NOT PUT ANY OBJECT INTO THE MONITOR**

Do not put any solid objects or liquids such as water into the monitor. In case of an accident, unplug your monitor immediately and contact your dealer or iiyama service center. Using the monitor with any object inside may cause fire, electric shock or damage.

#### **INSTALL THE MONITOR ON A FLAT, STABLE SURFACE**

The monitor may cause an injury if it falls or is dropped.

#### **DO NOT USE THE MONITOR NEAR WATER**

Do not use where water may be splashed or spilt onto the monitor as it may cause fire or electric shock.

#### **OPERATE UNDER THE SPECIFIED POWER SUPPLY**

Be sure to operate the monitor only with the specified power supply. Use of an incorrect voltage will cause malfunction and may cause fire or electric shock.

#### **PROTECT THE CABLES**

Do not pull or bend the power cable and signal cable. Do not place the monitor or any other heavy objects on the cables. If damaged, the cables may cause fire or electric shock.

#### **ADVERSE WEATHER CONDITIONS**

It is advisable not to operate the monitor during a heavy thunder storm as the continual breaks in power may cause malfunction. It is also advised not to touch the plug in these circumstances as it may cause electric shock.

## CAUTION

### INSTALLATION LOCATION

Do not install the monitor where sudden temperature changes may occur, or in humid, dusty or smoky areas as it may cause fire, electric shock or damage. You should also avoid areas where the sun shines directly on the monitor.

### DO NOT PLACE THE MONITOR IN A HAZARDOUS POSITION

The monitor may topple and cause injury if not suitably located. Please also ensure that you do not place any heavy objects on the monitor, and that all cables are routed such that children may not pull the cables and possibly cause injury.

### MAINTAIN GOOD VENTILATION

Ventilation slots are provided to keep the monitor from overheating. Covering the slots may cause fire. To allow adequate air circulation, place the monitor at least 10 cm (or 4 inches) from any walls. Do not remove the tilt stand when operating the monitor. Ventilation slots on the back of the cabinet will be blocked and the monitor may overheat if the stand is removed. This may cause fire or damage. Operating the monitor on its back, side, upside down or on a carpet or any other soft material may also cause damage.

### DISCONNECT THE CABLES WHEN YOU MOVE THE MONITOR

When you move the monitor, turn off the power switch, unplug the monitor and be sure the signal cable is disconnected. If you do not disconnect them, it may cause fire or electric shock.

### UNPLUG THE MONITOR

If the monitor is not in use for a long period of time it is recommended that it is left unplugged to avoid accidents.

### HOLD THE PLUG WHEN DISCONNECTING

To disconnect the power cable or signal cable, always pull it by the plug. Never pull on the cable itself as this may cause fire or electric shock.

### DO NOT TOUCH THE PLUG WITH WET HANDS

Pulling or inserting the plug with wet hands may cause electric shock.

### WHEN YOU INSTALL THE MONITOR ON YOUR COMPUTER

Be sure the computer is strong enough to hold the weight of the monitor, otherwise, you may damage your computer.

## OTHERS

### ERGONOMIC RECOMMENDATIONS

To eliminate eye fatigue, do not operate the monitor against a bright background or in a dark room. For optimal viewing comfort, the monitor should be just below eye level and 40-60 cm (16-24 inches) away from your eyes. When using the monitor over a prolonged time, a ten minute break every hour is recommended as looking at the screen continuously can cause eye strain.

## SPECIAL NOTES ON LCD MONITORS

- The following symptoms are normal with LCD monitors and do not indicate a problem.

### NOTE

- When you first turn on the LCD monitor, the picture may not fit in the display area because of the type of computer that is used. In this case, adjust the picture position to the correct position.
- You may find slightly uneven brightness on the screen depending on the desktop pattern you use.
- Due to the nature of the LCD screen, an afterimage of the previous screen may remain after switching the image, when the same image is displayed for hours. In this case, the screen is recovered slowly by changing the image or turning off the Power Switch for hours.

- This LCD cannot be used outdoors.
- If you use a cable longer than the supplied one, the picture quality is not guaranteed. Touch function can be disrupted if the USB cable length exceeds 3m.

## USAGE CONFIRMATION

This product is designed for optimum usage at 24hours per day.

The display is compatible for usage in Landscape/Portrait and Tabletop (face-up) applications. If being used in Tabletop application, please utilise the Fan-on function.

## IMAGE PERSISTENCE / IMAGE STICKING

Please be aware that all LCD screens can experience Image Persistence or Image Sticking. This occurs when a residual image remains visible on a screen when static images are displayed for long periods of time. LCD Image Persistence is not permanent but constant images being displayed for a long period of time should be avoided.

To counteract Image Persistence, turn off the monitor for as long as the previous image was displayed, so if an image was on the monitor for 1 hour and there is evidence of a residual or “ghost” image, you should turn off the monitor for 1 hour in order to clear the residual image.

For all LFD products, iiyama recommends displaying moving images and utilising a moving screen saver at regular intervals whenever the screen is idle. You could also turn off the monitor when not in use to assist the prevention.

Other ways to reduce the risk of Image Persistence will be to utilise the FAN-on function (if available), Low Backlight and Low Brightness settings.

## FOR EXTENDED USE AS A PUBLIC DISPLAY

### ■ Image Sticking on LCD Panel

When a static image is displayed for hours, an electric charge trace remains near the electrode inside the LCD producing a “ghost” image. (Image Persistence).

Image Persistence is not a permanent feature.

### ■ Recommendations

To prevent Image Sticking and promote longer life expectancy of display, we recommend the following:

1. Avoid static images displayed for long periods – change static images on continuous loop.
2. Turn off monitor when not in use, either by remote control or use Power Management or Schedule functions.
3. When monitor is installed in high ambient temperature environment(s) or in an enclosed position, utilise the Cooling Fan, Screen Saver and Low Brightness functions.
4. Suitable ventilation for any monitor is an expectation of any installation – climate control systems may need to be employed.
5. We strongly recommend utilisation of active cooling with fans for long operation times or high ambient temperature environments.

## CUSTOMER SERVICE

### NOTE

- If you have to return your unit for service and the original packaging has been discarded, please contact your dealer or iiyama service center for advice or replacement packaging.

## CLEANING

### WARNING

- If you drop any materials or liquids such as water into the monitor when cleaning, unplug the power cable immediately and contact your dealer or iiyama service center.

### CAUTION

- For safety reasons, turn off the power switch and unplug the monitor before you clean it.

### NOTE

- To protect the LCD panel, do not scratch or rub the screen with a hard object.
- Never use any of the following strong solvents. These will damage the cabinet and the LCD screen.

Thinner	Benzine	Abrasive cleaner
Spray-type cleaner	Wax	Acid or Alkaline solvent

- Touching the cabinet with any product made from rubber or plastic for a long time may cause degeneration or loss of paint on the cabinet.

### CABINET

Stains can be removed with a cloth lightly moistened with a mild detergent solvent. Then wipe the cabinet with a soft dry cloth.

### LCD

Periodic cleaning with a soft dry cloth is recommended.

### SCREEN

Don't use tissue paper etc. because these will damage the LCD screen.



# BEFORE YOU OPERATE THE MONITOR

## FEATURES

- ◆ Pixel format 3840 × 2160 (RGBW)
- ◆ High Contrast 1000:1 (Typical) / Brightness 500cd/m<sup>2</sup> (Typical: without Touch panel)
- ◆ Digital Character Smoothing
- ◆ Automatic Set-up
- ◆ Stereo Speakers  
2 × 8W Stereo Speakers
- ◆ Plug & Play VESA DDC2B Compliant  
Windows<sup>®</sup> 7/8.1/10 Compliant
- ◆ Power Management (VESA DPMS Compliant)
- ◆ VESA Mounting Standard (600mm×400mm) Compliant
- ◆ Support 24hrs/day usage (by moving picture condition)
- ◆ IPX1 Standard Compliant (Only front face)

## CHECKING THE CONTENTS OF THE PACKAGE

The following accessories are included in your package. Check to see if they are enclosed with the monitor. If anything is missing or damaged, please contact your local iiyama dealer or regional iiyama office.

- |  |                              |                                    |
|--|------------------------------|------------------------------------|
| ■ Power Cable*                               | ■ HDMI Cable                 | ■ DisplayPort Cable                |
| ■ USB Cable                                  | ■ IR Extender Cable          | ■ Remote Control (For maintenance) |
| ■ Button Battery CR2025 (for Remote Control) | ■ Clamper (For tying cables) |                                    |
| ■ Cable Cover                                | ■ Safety Guide               | ■ Quick Start Guide                |

### CAUTION

\* The rating of the Power Cable enclosed in 120V area is 10A/125V. If you are using a power supply higher than this rating, then a power cable with a rating of 10A/250V must be used. However, all guarantees and warranties are void for any problems or damage caused by a power cable not supplied by iiyama.

## UNPACKING

- ① Before unpacking your monitor, prepare a stable, level, and clean surface near a wall outlet. Set the LCD Monitor box in an upright position and open from the top of the box before removing the top cushions.
- ② Remove the carton holders.
- ③ Remove the top cushion and take the accessories box and the Monitor out.

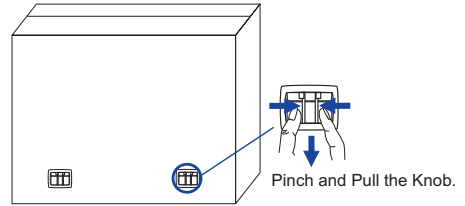

### CAUTION

Moving the monitor requires at least two people. If not, it may drop and could result in a serious injury. When moving/shipping the monitor, please hold by the carton holders.

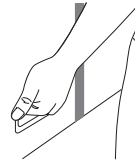

## SPECIAL NOTES ON

### CAUTION

Permanent damage can occur if Sharp Edged, Pointed or Metal items are used to activate Touch. This could invalidate any remaining warranty. We recommend to use a conductive rubber pen (tip  $\varnothing 7.0$  or over) or finger.

# CONTROLS AND CONNECTORS : MONITOR

<Front>

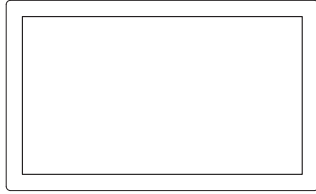

<Back>

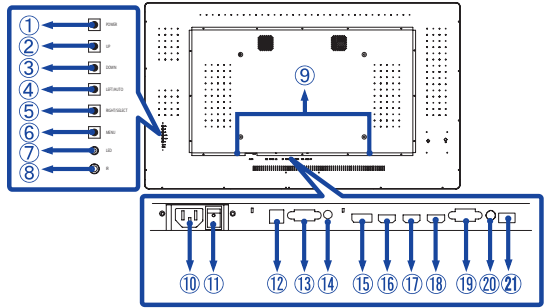

①	POWER	Power Button	
②	UP	Up/Volume - Button	
③	DOWN	Down/Volume + Button	
④	LEFT / AUTO	Left/Auto Button	
⑤	RIGHT / SELECT	Right/Input Select Button	
⑥	MENU	Menu Button	
⑦	LED	Green	Normal Operation
		Orange	Power Management
⑧	IR	Remote Sensor	
⑨	SPEAKERS	Speakers	
⑩	AC IN	AC-INLET	AC Connector( ~ : Alternating current) (AC-IN)
⑪	AC SWITCH — (ON) / ○ (OFF)	MAIN POWER	Main Power Switch
⑫	USB	USB	Touch USB Connector
⑬	RS232	RS232C 9pin	RS232C Connector
⑭	IR	Mini Jack	IR Extender Connector
⑮	DP	DisplayPort	DisplayPort Connector
⑯	HDMI1	HDMI	HDMI Connector
⑰	HDMI2		
⑱	HDMI3		
⑲	VGA	VGA	VGA Connector
⑳	Audio	Mini Jack	Audio Connector
㉑	MP(USB)	Media USB	Media Player

## INSTALLATION

### CAUTION

- Follow the manual instructions for the type of mount you have selected. Refer all servicing to qualified service personnel.
- Moving the monitor requires at least two people.
- Before installing, please make sure the wall is strong enough to hold the necessary weight of the display and the mount.

### [WALL MOUNTING]

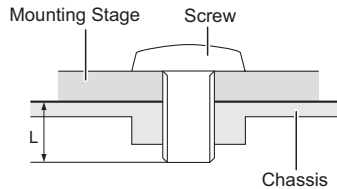

### CAUTION

When using the wall mounting, consideration of thickness of the mounting stage needs to be taken. Tighten the M8 Screw with washer which "L" length is 10mm to fasten the monitor. Using a screw longer than this may cause electric shock or damage because it may contact with the electrical parts inside the monitor.

### [FAN]

### CAUTION

If the screen is used in face-up position, please be sure to turn on the FAN function. If you do not use the FAN, the internal temperature rises and the product life cycle may get shorter. If the screen is built into an external cabinet, please be sure to implement a cooling unit inside of the cabinet. Dirt and dust may stick to the FAN, reducing the cooling effect which may result in a shorter life cycle of the product. Please clean regularly.

## [ROTATING THE DISPLAY]

It is designed to be compatible in both landscape and portrait modes.

ENGLISH

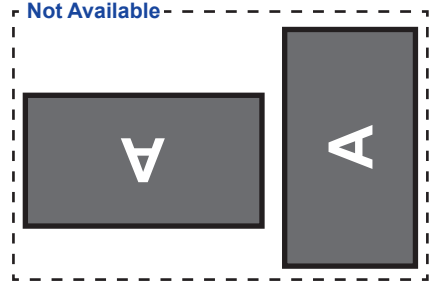
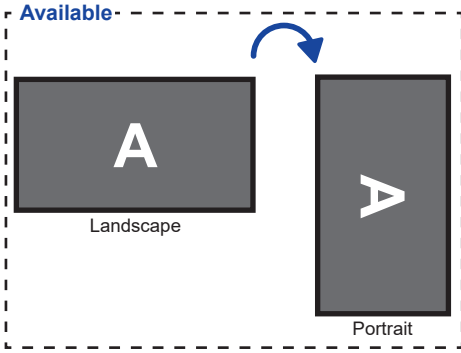

## CONTROLS AND CONNECTORS : REMOTE CONTROL (For maintenance)

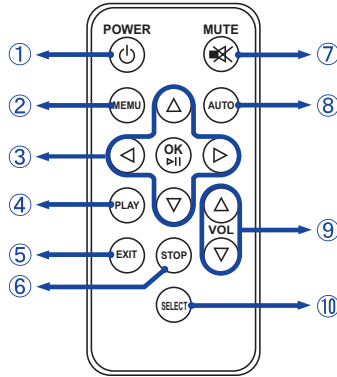

### NOTE

To use the remote control we advise you to position it at the back of the monitor (left side) where the remote sensor is located. It might not work if you use it standing in front of the monitor.

①	POWER	Turns the monitor ON and OFF.
②	MENU	Opens the monitor's on-screen menu systems. When the menu system is already open, pressing this button will select the previous submenu.
③	▲▼◀▶	Navigates through submenus and settings. ▲: Up Button ▼: Down Button ◀: Left Button ▶: Right Button
	OK	Confirms your selection or save changes. Press the OK Button when the Menu is not displayed. Displays information regarding the current input signal coming from the graphic card in your computer.
④	PLAY	Play Photo, Music, Movie, Text in Media player menu.
⑤	EXIT	Returns to a previous menu or closes the OSD Menu.
⑥	STOP	Stop Photo, Music, Movie, Text in Media player menu.
⑦	MUTE	Turns on or off the Mute function.
⑧	AUTO	Adjust H. / V. Position, Clock and Phase automatically.
⑨	VOL	▲: Increases the sound volume. ▼: Decreases the sound volume.
⑩	SELECT	Selects the source. (PC-RGB/HDMI1/HDMI2/HDMI3/DP)

## PREPARING THE REMOTE CONTROL

To use the remote control, insert the button battery.

### CAUTION

Do not use any other batteries other than those specified in this manual for the Remote Control. Burst batteries or the electrolyte from these batteries may cause stains, fire or injury.

- ① Push Lock to right and remove the battery case in the direction of the arrow.



- ② Put it in face up the + side of the button battery (CR2025).

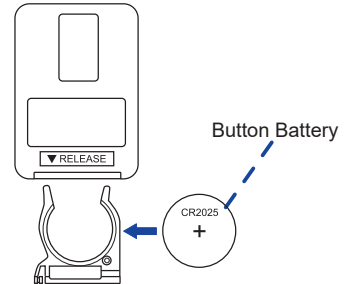

- ③ Replace the battery case in the direction of the arrow.

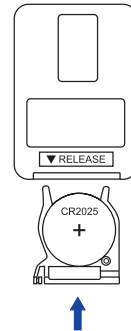

### NOTE

- Replace with new batteries when the Remote Control does not work close to the monitor. Use the button battery (CR2025).
- Operate the Remote Control by pointing it toward the Remote Sensor on the monitor.
- Other manufacturers remote control will not work with this monitor. Use the provided Remote Control ONLY.
- Used batteries needed to follow the local rules to be discarded. (Suggestion: to dispose of used batteries please follow correct policy as per your local regulations.)

## BASIC OPERATION

### ■ Turning the monitor ON

The monitor is on and the Power Indicator turns Green when you press the Power Button on the monitor or the Remote Control. The monitor is off and the Power Indicator turns Orange when you press the Power Button on the monitor or the Remote Control. Press again to turn the monitor on.

#### NOTE

Even when using the power management mode or turning OFF the Power Switch, the monitor will consume a small amount of electricity. Disconnect the Power Cable from the power supply whenever the monitor is not in use or during the night, to avoid unnecessary power consumption.

#### [Monitor]

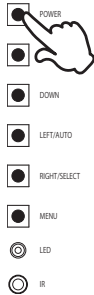

#### [Remote Control]



### ■ Display the adjustment menu page

The menu page appears on the screen when you press the MENU Button on the monitor or the Remote Control.

The menu page disappears when you press the EXIT Button on the Remote Control.

#### [Monitor]

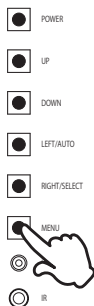

#### [Remote Control]

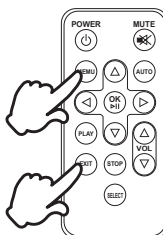



■ **Move the cursor vertically**

Select adjustment by pressing the UP / DOWN Button on the monitor or the ▲ / ▼ Button on the Remote Control while the menu page is displayed on the screen.

[Monitor]

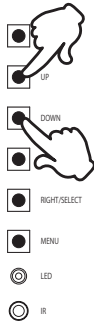

[Remote Control]



■ **Move the cursor horizontally**

Select menu or setting, or perform the adjustment by pressing the LEFT / RIGHT Button on the monitor or the ◀ / ▶ Button on the Remote Control while the menu page is displayed on the screen.

[Monitor]

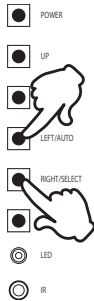

[Remote Control]

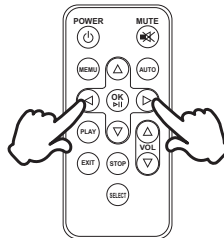

■ **Adjust the volume of sound**

Press the UP / DOWN Button on the Monitor or the VOL ▲ / ▼ Button on the Remote Control to adjust the volume of sound when the menu page is not displayed on the screen.

[Monitor]

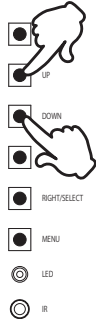

[Remote Control]

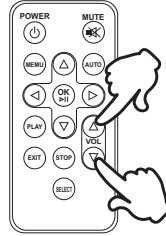

■ **Switch the input signal**

This is activated when you successively press the SELECT Button on the monitor or the Remote Control.

[Monitor]

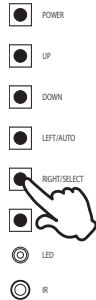

[Remote Control]

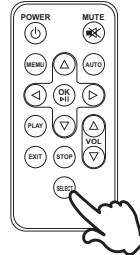

## CONNECTING YOUR MONITOR

- ① Ensure that both the computer and the monitor are switched off.
- ② Connect the computer to the monitor with the signal cable.
- ③ Connect the computer to the monitor with the USB Cable.
- ④ Connect the IR Extender Cable to the monitor, peel off the double-sided tape in the back of the IR Receiver and stick it to your preferred location.
- ⑤ Connect the Power Cable to the monitor first and then to the power supply.
- ⑥ Turn on your monitor (Main Power Switch and Power Switch) and computer.
- ⑦ **When the power is turned on, press the SELECT button and the input signal menu will be displayed. Then select the input signal.**

**NOTE** ■ The signal cables used for connecting the computer and monitor may vary with the type of computer used. An incorrect connection may cause serious damage to both the monitor and the computer. The cable supplied with the monitor is for a standard connector. If a special cable is required please contact your local iiyama dealer or regional iiyama office.

- Make sure you tighten the finger screws at each end of the Signal Cable.
- When USB cable connected then wait for 5 seconds and the touch function is ready to go. It can be activated by pen, finger or any other pointer.

[Example of Connection]

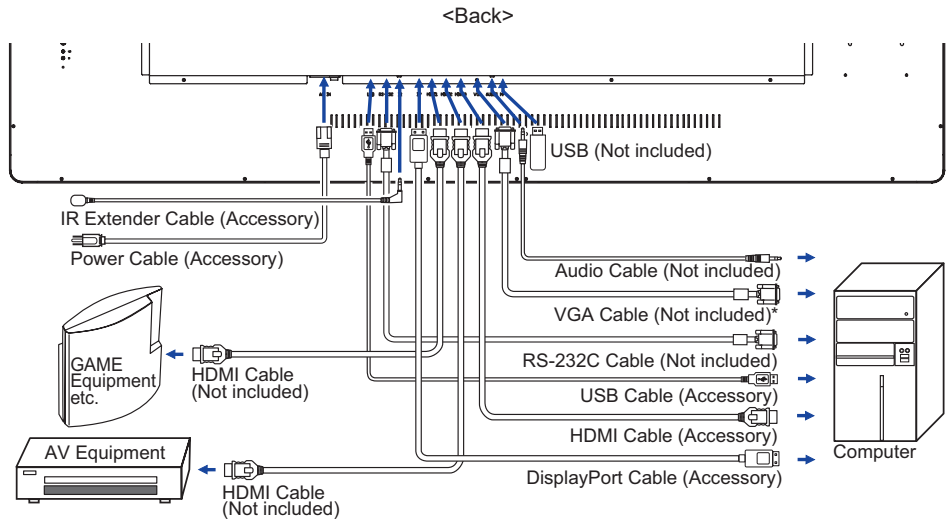

\* VGA cable is not supplied with the monitor. If you use low quality VGA cable, it may cause a result of electro-magnetic interference. Please contact the iiyama Support Centre in your country if you wish to connect the monitor via the VGA input.

### [ Cable Cover ]

Place the cable cover and fix it firmly using two screws that are included.

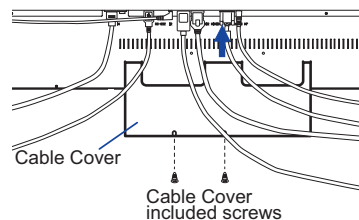

## COMPUTER SETTING

### ■ Signal Timing

Change to the desired signal timing listed on page 38: COMPLIANT TIMING.

### ■ Procedure for turning ON the Power Switch

Turn ON the monitor first, and then the computer.

### ■ MULTI-TOUCH

This monitor complies with DDC2B of VESA standard. (Plug&play compliant)

The MULTI-TOUCH function runs on Windows7/8/8,1/10 by connecting the monitor to DDC2B compliant computer with the USB cable supplied.

### ■ MULTI-TOUCH support operation system

Microsoft Windows 7 (64 bit and 32 bit)

Microsoft Windows 8/8,1/10 (64 bit and 32 bit)

Linux (3.8) & above

Not support Windows 2000 and earlier versions.

	Windows8/8,1/10	Windows7*5	Windows7*4	Linux
Default mouse*1	○	○	○	○
Touch digitizer*2	○	○	○	×
Windows7 gestures*3	○	○	×	×

\*1 Default mouse (click, drag, double-click and right-click)

\*2 Touch digitizer (click, drag /selection, double-click, right-click, flick and visual feedback)

\*3 Digitizer with Windows7 multi-touch gestures

\*4 Windows 7 - Starter and Home Basic version

\*5 Windows 7 - Home Premium, Professional, Enterprise and Ultimate versions

# OPERATING THE MONITOR

To create the best picture, your iiyama LCD monitor has been preset at the factory with the COMPLIANT TIMING shown on page 38. You are also able to adjust the picture by following the button operation shown below. For more detailed adjustments, see page 30 for SCREEN ADJUSTMENTS.

- 1 Press the MENU Button to start the On Screen Display feature. There are additional Menu items which can be switched by using the ◀/▶ Buttons.

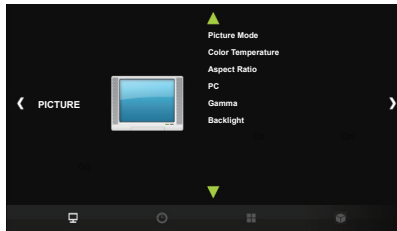

- 2 Select the Menu item of the adjustment you want to make. Press the OK Button and enter the menu page. Then, use the ◀/▶ Buttons to highlight the desired adjustment item.
- 3 Press the OK Button again. Use the ◀/▶ Buttons to make the appropriate adjustment or setting.
- 4 Press the EXIT Button to leave the menu, and the settings you just made would be automatically saved.

For example, to correct for vertical position, select Menu item of "PICTURE". Select "PC" by using the ◀/▶ Buttons. Press the OK Button. Then select "Vertical Pos." by using the ◀/▶ Buttons. Press the OK Button.

Use the ◀/▶ Buttons to change the vertical position settings. The vertical position of the overall display should be changing accordingly while you are doing this.

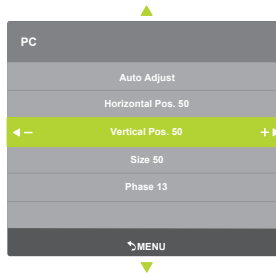

## NOTE

- When button operations are aborted during adjustment, On-Screen Display disappears when the time set for the Menu time has passed.
- The MENU Button can be used to return previous menu item.
- Any changes are automatically saved in the memory when the On Screen Display disappears. Turning off the power should be avoided while using the Menu.
- Adjustments for Horizontal / Vertical Pos., Size and Phase are saved for each signal timing. Except for these adjustments, all other adjustments have only one setting which applies to all signal timings.

● **LOCK MODE:**

**<Monitor OSD key>**

Pressing and holding the MENU button and the UP button for about 3 seconds when the Menu is not displayed.

**<Remote Control>**

1.Press the SELECT button when the menu is not displayed.

2.Press the ▼ button, ► button, ▼ button, ► button.

\* To release the Remocon Lock, display the LOCK MODE menu with the OSD key and release it.

The following OSD menu is displayed.

Adjustment Item	Problem / Option	
OSD Lock	On	The OSD menu is Locked.
	Off	The OSD menu is Unlocked.
Power Key Lock	On	The POWER SWITCH is Locked.
	Off	The POWER SWITCH is Unlocked.
Remocon Lock	On	The Remote Control is Locked.
	Off	The Remote Control is Unlocked.

- The OSD menu is not displayed when the OSD is locked.

To unlock monitor OSD key, Pressing and holding the MENU button and the UP button for about 3 seconds when the Menu is not displayed.

To unlock the Remote Control, Press the SELECT button when the menu is not displayed. Then, press the ▼ button, ► button, ▼ button, ► button.

● **PALM REJECTION FUNCTION:**

Palm rejection is a way to disregard touch made with “a large contact area” while using pen or finger modes.

A large contact area : palm, clenched fist, elbow, arm, etc.

When you touch the screen with a pen or a finger, palm rejection is activated and the screen does not recognize touch made with the large contact area.

**NOTE**

The screen works only with conductive pens with  $\Phi 5\text{-}6\text{mm}$  diameter.

The touch panel does not recognize pens with smaller or large diameter.

Touch made by a pen is not recognized within 15mm distance from edge of the active display area.

# ADJUSTMENT MENU CONTENTS

## PICTURE

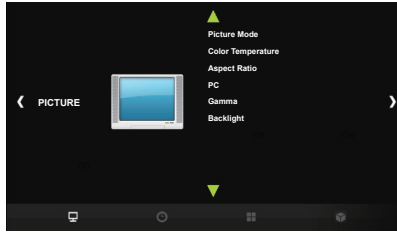

Adjustment Item	Problem / Option		Button to Press	
Picture Mode	Vivid	For displaying outdoor scenery images.		
	Standard	For general windows environment and monitor default setting.		
	Soft	For displaying softly outline images.		
	User	Contrast	Too dull	← →
			Too intense	← →
		Brightness *1	Too dark	← →
			Too bright	← →
Color	Purplish	← →		
	Greenish	← →		
Sharpness	You can change the picture quality from 0 to 4 (soft to sharp). Press the ◀ Button to change the picture quality in numerical order. Press the ▶ Button to change the picture quality in reverse numerical order.		← →	
Color Temperature	Cool	Bluish white		
	Medium	Greenish white		
	Warm	Reddish white		
	User	Red	Too weak	← →
		Green		
Blue		Too strong	← →	
Aspect Ratio	Full	Full screen display		
	4:3 *2	Displays all picture in 4:3 aspect ratio.		
	5:4 *2	Displays all picture in 5:4 aspect ratio.		
	16:9 *2	Displays all picture in 16:9 aspect ratio.		
	16:10 *2	Displays all picture in 16:10 aspect ratio.		
	Zoom1 *3	Enlarge display		
	Zoom2 *3	Enlarge display even more		









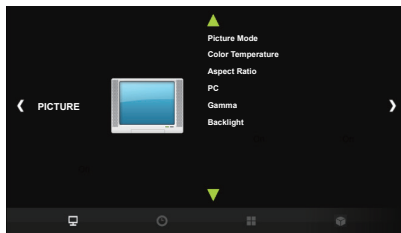













\*1 Adjust the Brightness when you are using the monitor in a dark room and feel the screen is too bright.

\*2 It can display in the center of the screen with a 4:3, 5:4, 16:9 or 16:10 aspect ratio when input video resolution is 4:3, 5:4, 16:9 or 16:10.

\*3 Supported for HDMI and DisplayPort only.

# PICTURE



Adjustment Item	Problem / Option		Button to Press
PC * <sup>4</sup>	Auto Adjust * <sup>5</sup>	Adjusts Position, Size and Phase automatically.	
	Horizontal Pos.	 Too far to the left	 
		 Too far to the right	 
	Vertical Pos.	 Too low	 
		 Too high	 
Size	 Too narrow	 	
	 Too wide	 	
Phase	To correct flickering text or lines		 
Gamma * <sup>6</sup>	You can set the Gamma. 1.8 / 2.2		
Backlight	Brightness of back light is reduced.		 

\*<sup>4</sup> Only PC-RGB(VGA) input.

\*<sup>5</sup> For best results, use the Auto Adjust in conjunction with the adjustment pattern. See page 30 for SCREEN ADJUSTMENTS.

\*<sup>6</sup> This item is switched by pressing the OK button successively.



## SCHEDULE



Adjustment Item	Problem / Option	Button to Press
Date and Time	Adjust the current date and time for the internal clock. Date / Month / Year / Hour / Minute	
Off Time	Sets a recurring schedule. Off / Once / Every Day / Mon. - Fri. / Mon. - Sat. / Sat. - Sun. / Sunday	Hour / Minute
On Time	Sets a recurring schedule. Off / Once / Every Day / Mon. - Fri. / Mon. - Sat. / Sat. - Sun. / Sunday	Hour / Minute / Source (PC-RGB/ HDMI1/HDMI2/ HDMI3/DP)
Reset	Resets all settings in the Schedule menu.	

## OPTION

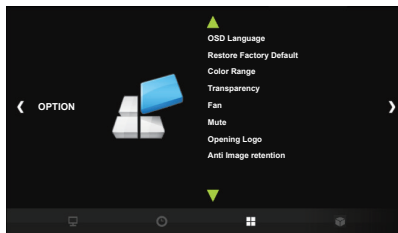

Adjustment Item	Problem / Option				Button to Press
OSD Language	English	English	Nederlands	Dutch	
	Français	French	Polski	Polish	
	Español	Spanish	Русский	Russian	
	Deutsch	German	Italiano	Italian	
Restore Factory Defalut	Yes	Factory-preset data is restored.			
	No	Return to Menu.			
Color Range *2,3	Full	For full-range color scale signal			
	Limit	For limited color scale signal			
	Auto	For detect color signal			
Transparency	Set the transmittance of the OSD background. 0% / 25% / 50% / 75% / 100%				
Fan *1,2	On	Fan is turned on.			
	Off	Fan is turned off.			
Mute *2	On	Turn off the sound temporarily.			
	Off	Return the sound volume to the previous level.			
Opening Logo *2	On	iiyama Logo displayed when the monitor is turned on.			
	Off	iiyama Logo does not display when the monitor is turned on.			
Anti Image retention *2	On	Automatically displays swift moving patterns every 1 second to prevent image retention on the screen.			
	Off	Anti Image Retention is turned off.			

\*1 If the screen is used in face-up position, please be sure to turn on the FAN function.

\*2 This item is switched by pressing the OK button successively.

\*3 Digital input only.

## Applications

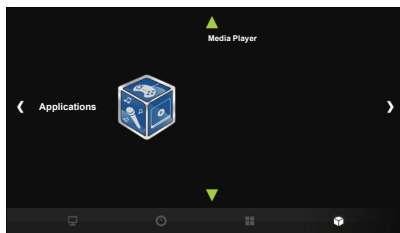

Adjustment Item	Problem / Option	Button to Press
Media Player	Go to the Media Player menu.	

### [Play Multimedia Files]

You can play photos, music, movies and texts on your monitor from:

- A USB device connected to this monitor.

#### ● Play multimedia files from USB device

To play files on an external USB storage device, simply plug the device into the USB A jack on the monitor.

1. Connect your USB device to the USB port on this monitor.
2. In the "Applications" of the OSD menu, select Media Player.
3. Uses the remote control and follow the On - Screen instructions to operate.

#### ■ USB Standard:

USB2.0

#### ■ Supported file system:

FAT32

## ■ Supported file format:

### • Music:

Audio Codec	Sample rate	Channel	Bit Rate	Container
MPEG1/2 Layer1	16KHz - 48KHz	Up to 2	32Kbps - 448Kbps	<b>Movie:</b> AVI(.avi), ASF(.asf), DivX(.divx), Matroska(.mkv), MPEG transport stream(.ts, .trp, .tp), MPEG program stream(.DAT, .VOB, .MPG, .MPEG) <b>Music:</b> WAV(.wav), MP3(.mp3)
MPEG1/2 Layer2	16KHz - 48KHz	Up to 2	8Kbps - 384Kbps	<b>Movie:</b> AVI(.avi), ASF(.asf), DivX(.divx), Matroska(.mkv), MPEG transport stream(.ts, .trp, .tp), MPEG program stream(.DAT, .VOB, .MPG, .MPEG) <b>Music:</b> WAV(.wav), MP3(.mp3)
MPEG1/2 Layer3	16KHz - 48KHz	Up to 2	8Kbps - 320Kbps	<b>Movie:</b> AVI(.avi), ASF(.asf), DivX(.divx), Matroska(.mkv), 3GPP(.3gpp, .3gp), MP4(.mp4, mov) MPEG transport stream(.ts, .trp, .tp), MPEG program stream(.DAT, .VOB, .MPG, .MPEG), FLV(.flv), SWF(.swf) <b>Music:</b> WAV(.wav), MP3(.mp3), MP4(.mp4)

### • Movie:

Video Codec	Resolution	Bit Rate	Profile	Container
MPEG1/2	1080P@30fps	40Mbps	MP@HL	MPEG transport stream(.ts, .trp, .tp), MPEG program stream(.DAT, .VOB, .MPG, .MPEG) 3GPP(.3gpp, .3gp), MP4(.mp4, mov), AVI(.avi), MKV(.mkv), ASF(.asf)
MPEG4	1080P@30fps	40Mbps	-Simple Profile -Advanced Simple Profile@Level5 -GMC is not supported	MPEG program stream(.MPG, .MPEG) 3GPP(.3gpp, .3gp), MP4(.mp4, mov), AVI(.avi), MKV(.mkv), ASF(.asf)
XviD				DivX(.divx), MP4(.mp4, mov), AVI(.avi), MKV(.mkv), ASF(.asf)

• Photo: JPEG, BMP, PNG

• Text: txt

## ●Viewing Photo files

1.Select "Photo" and press the OK button, then select "C" and press the OK button.

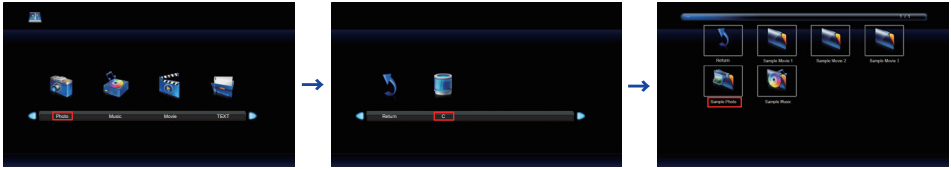

2.Select the Photo file and press the OK button.

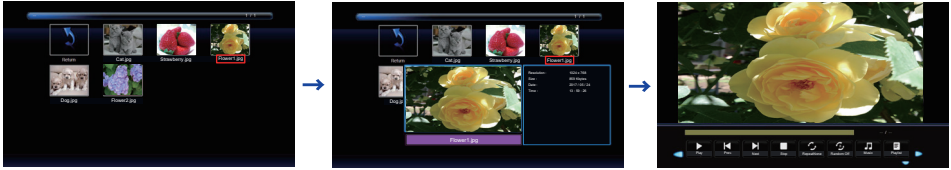

### <Operation Menu>

- **Menu Display** : Press the OK button on the remote control.
- **Menu non-Display** : Press the ▼ / EXIT button on the remote control.
- **Return** : Previous screen
- **▶ Play** : Plays Slideshow (All photo or Choice photo)
- **|| Pause** : Pauses Slideshow
- **◀ Prev.** : Previous Photo
- **▶ Next** : Next Photo
- **■ Stop** : Stops Slideshow
- **↺ Repeat** : Set number of times to repeat Slideshow (Repeat is switched as following by pressing the OK Button successively.)
  - Repeat All** : Repeat the whole section continuously
  - Repeat None** : Do not repeat
  - Repeat 1** : Repeat entire section 1 time
- **Ⓡ Random** : Set the Random Photo (Random is switched as following by pressing the OK Button successively.)
  - Random off** : Proceed in order
  - Random on** : Progress randomly
- **🎵 Music** : Music On / Off (Music On/Off is switched by pressing the OK Button successively. If there is a music file in the same device, music will be played if it is set to On. All music will be played, but if there is music selected by MUSIC (from the Player menu) , it plays with priority.)
- **☰ Playlist** : Displays the Photo list
- **ⓘ Info** : Displays the current file status information.
- **🕒 Rotate(clockwise)** : Rotates the image 90° clockwise.
- **🕒 Rotate(counter clockwise)** : Rotates the image 90° counterclockwise.
- **🔍 Zoom In** : Zoom in the image.
- **🔍 Zoom Out** : Zoom out the image.
- **📏 Move View** : Move focus in Zoom In state
- **⚙️ Slide Show** : **Normal** : Squential Slideshow  
**Random** : Slideshow by Random

## ●Playing Music files

1.Select "Music" and press the OK button, then select "C" and press the OK button.

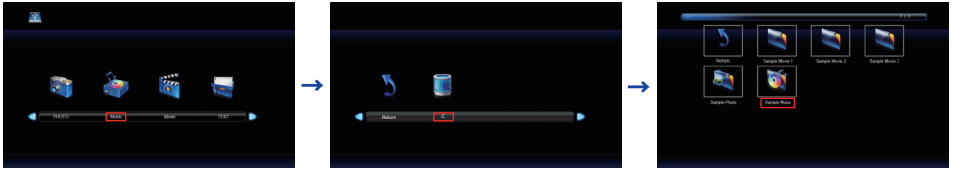

2.Select the Music file and press the OK button.



### <Operation Menu>

- **Menu Display** : Press the OK button on the remote control.
- **Menu non-Display** : Press the ▼ / EXIT button on the remote control.
- **Return** : Previous screen
- **▶ Play** : Plays Music (All music or Choice music)
- **|| Pause** : Pauses Music
- **◀◀ FB** : Fast Backward
- **▶▶ FF** : Fast Forward
- **◀ Prev.** : Previous Music
- **▶ Next** : Next Music
- **■ Stop** : Stops Music
- **🔄 Repeat** : Set number of times to repeat Music. (Repeat is switched as following by pressing the OK Button successively.)
  - Repeat All** : Repeat the whole section continuously.
  - Repeat None** : Do not repeat.
  - Repeat 1** : Repeat entire section 1 time.
- **AB Set** : Section Repeat (Section Repeat is switched as following by pressing the OK Button successively.)
  - None** : Do not use.
  - Set A** : Start of repeat section.
  - Set B** : End of repeat section.
  - (AB Set : Repeat endlessly the section set with A - B.)
- **🎲 Random** : Set the Random Music (Random is switched as following by pressing the OK Button successively.)
  - Random off** : Proceed in order
  - Random on** : Progress randomly
- **🔇 Mute** : Mute On / Off (Mute is switched by pressing the OK Button successively.)
- **📄 Playlist** : Displays the Music list
- **ⓘ Info** : Displays the current file status information.

## ●Playing Movie files

1.Select "Movie" and press the OK button, then select "C" and press the OK button.

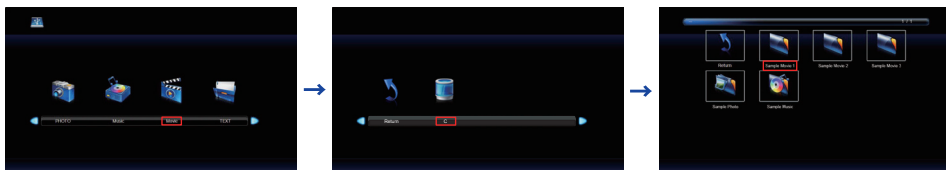

2.Select the Movie file and press the OK button.

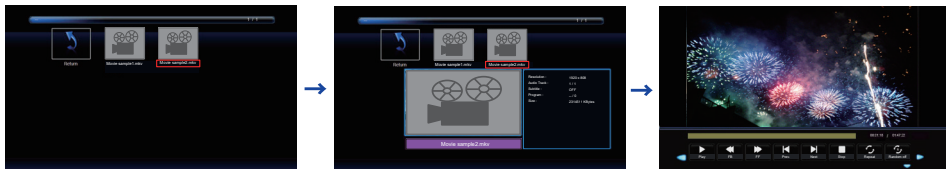

### <Operation Menu>

- **Menu Display** : Press the OK button on the remote control.
- **Menu non-Display** : Press the ▼ / EXIT button on the remote control.
- **Return** : Previous screen
- **▶ Play** : Plays Movie (All movie or Choice movie)
- **|| Pause** : Pauses Movie
- **◀◀ FB** : Fast Backward
- **▶▶ FF** : Fast Forward
- **◀◀ Prev.** : Previous Movie
- **▶▶ Next** : Next Movie
- **■ Stop** : Stops Movie
- **🔄 Repeat** : Set number of times to repeat Movie. (Repeat is switched as following by pressing the OK Button successively.)
  - Repeat All** : Repeat the whole section continuously.
  - Repeat None** : Do not repeat.
  - Repeat 1** : Repeat entire section 1 time.
- **🎲 Random** : Set the Random Movie (Random is switched as following by pressing the OK Button successively.)
  - Random off** : Proceed in order
  - Random on** : Progress randomly
- **🔁 Set** : Section Repeat (Section Repeat is switched as following by pressing the OK Button successively.)
  - None** : Do not use.
  - Set A** : Start of repeat section.
  - Set B** : End of repeat section.
  - (AB Set : Repeat endlessly the section set with A - B.)
- **📄 Playlist** : Displays the Movie list
- **📄 Info** : Displays the current file status information.
- **▶▶ Slow Forward** : Slow Forward
- **▶▶▶ Step Forward** : Step Forward
- **🔍 Zoom In** : Zoom in the image.
- **🔍 Zoom Out** : Zoom out the image.
- **⚙️ Aspect Ratio** : Auto / 4:3 /16:9 (Aspect Ratio is switched by pressing the OK Button successively.)
- **📄 Move View** : Move focus in Zoom In state

## ● Viewing Text files

1. Select "Text" and press the OK button, then select "C" and press the OK button.

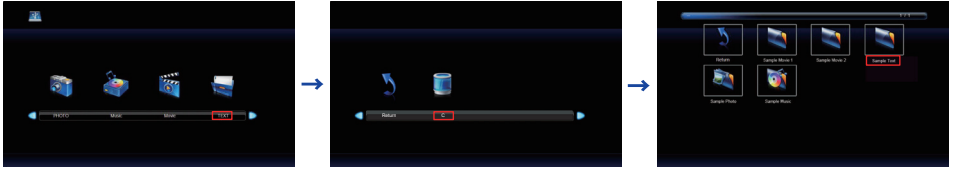

2. Select the Text file and press the OK button.

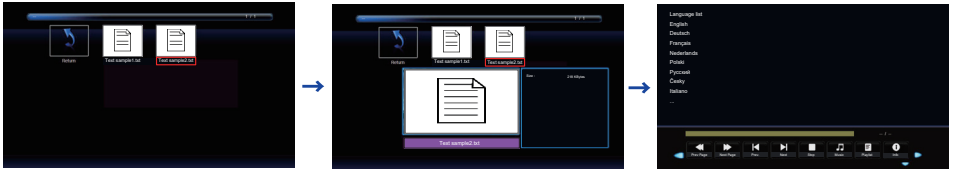

### <Operation Menu>

- **Menu Display** : Press the OK button on the remote control.
- **Menu non-Display** : Press the ▼ / EXIT button on the remote control.
- **Return** : Previous screen
- **◀◀ Prev. Page** : Previous Page
- **▶▶ Next Page** : Next Page
- **◀ Prev.** : Previous Text
- **▶ Next** : Next Text
- **■ Stop** : Stops Text
- **🎵 Music** : Music On / Off (Music On/Off is switched by pressing the OK Button successively.  
If there is a music file in the same device, music will be played if it is set to On. All music will be played, but if there is music selected by MUSIC (from the Player menu) , it plays with priority.)
- **📄 Playlist** : Displays the Text list
- **📄 Info** : Displays the current file status information.



## SCREEN ADJUSTMENTS

Adjust the image by following the procedure below to get the desired picture when selecting Analog input.

- The screen adjustments described in this manual are designed to set image position and minimize flicker or blur for the particular computer in use.
- The monitor is designed to provide the best performance at resolution of 1920 × 1080, but can not provide the best at resolutions of less than 1920 × 1080 because the picture is automatically stretched to fit the full screen. It is recommended to operate at resolution of 1920 × 1080 in normal use.
- Displayed text or lines will be blurred or irregular in thickness when the picture is stretched due to the screen enlargement process.
- It is preferable to adjust the image position and frequency with the monitor controls, rather than the computer software or utilities.
- Perform adjustments after a warm-up period of at least thirty minutes.
- Additional adjustments may be required after the Auto Adjust depending on the resolution or signal timing.
- The Auto Adjust may not work correctly when displaying the picture other than the screen adjustment pattern. In this case, manual adjustments are required.

There are two ways to adjust the screen. One way is automatic adjustment for Position, Clock Frequency and Phase. The other way is performing each adjustment manually.

Perform the Auto Adjust first when the monitor is connected to a new computer, or resolution is changed. If the screen has a flicker or blur, or the picture does not fit in the display area after performing the Auto Adjust, manual adjustments are required. Both adjustments should be made by using the screen adjustment pattern (Test.bmp) obtained via the IYAMA web site (<http://www.iiyama.com>).

Adjust the image by following the procedure below to get the desired picture.  
This manual explains adjustment under Windows® OS.

- ① **Display the picture at the optimum resolution.**
- ② **Enter the Test.bmp (screen adjustment pattern) to wallpaper.**

- NOTE**
- Consult the appropriate documentation for doing this.
  - Test.bmp is made at resolution of 1280 × 1024. Set the display position to center in the wallpaper setting dialogue box. If you use Microsoft® PLUS! 95/98 cancel the setting of “Stretch desktop wallpaper to fit the screen”.

[Adjustment pattern]

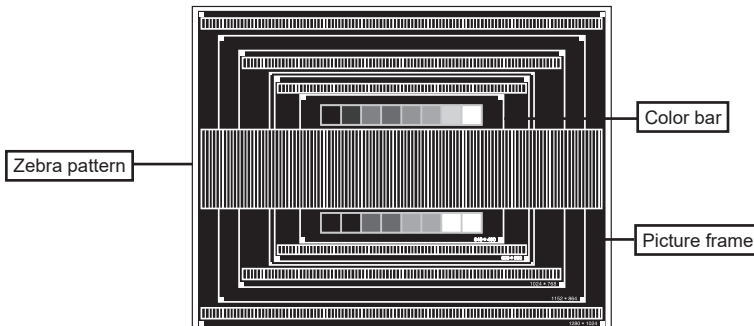

③ Adjust the Auto Adjustment.

④ Adjust the image manually by following procedure below when the screen has a flicker or blur, or the picture does not fit in the display area after performing the Auto Adjust.

⑤ Adjust the V-Position so that the top and bottom of the picture frame will fit to the display area.

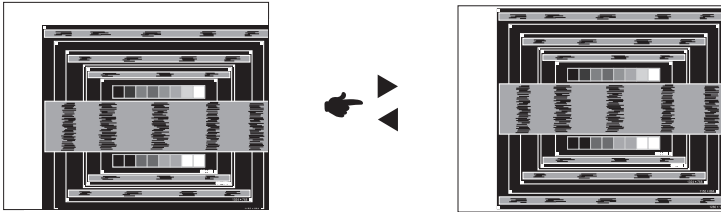

⑥ 1) Adjust the H-Position so that the left side of the picture frame will move to the left edge of the display area.

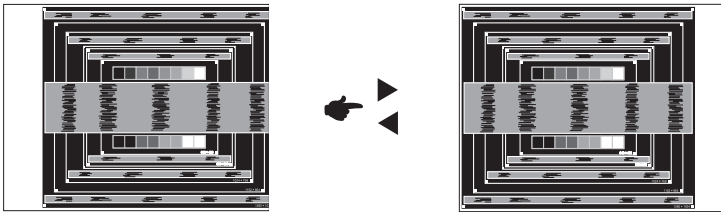

2) Stretch the right side of the picture frame to the right edge of the display area by adjusting the Clock Frequency.

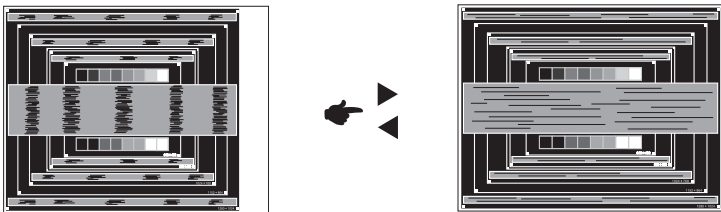

**NOTE**

- When the left side of the picture frame moves apart from the left edge of the display area during the Clock Frequency adjustment, adjust steps 1) and 2).
- Another way to make the Clock Frequency adjustment is to correct the vertical wavy lines in the zebra pattern.
- The picture may flicker during the Clock Frequency, H/V-Position adjustment.
- In case the picture frame is bigger or smaller than the data display area after the Clock Frequency adjustment, repeat steps from ③.

- ⑦ **Adjust the Phase to correct horizontal wavy noise, flicker or blur in the zebra pattern.**

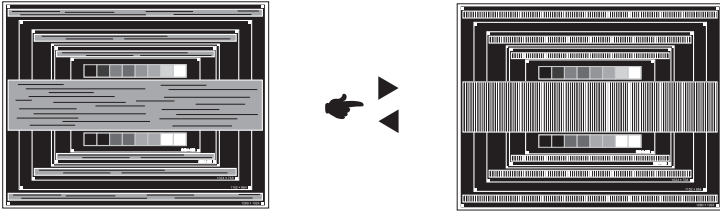

**NOTE**

- In case the strong flicker or blurs remain on a part of the screen, repeat steps ⑥ and ⑦ because the Clock Frequency may not be adjusted correctly. If the flicker or blurs still remain, set the refresh rate of computer to low (60Hz) and repeat steps from ③ again.
  - Adjust the H-Position after the Phase adjustment if the horizontal position moves during the adjustment.
- ⑧ **Adjust the Brightness and Color to get the desired picture after you complete the Clock Frequency and Phase adjustments.**  
**Put back your favorite wallpaper.**

## POWER MANAGEMENT FEATURE

The power management feature of this product complies with power saving requirement of VESA DPMS. When activated, it automatically reduces unnecessary power consumption of the monitor when your computer is not in use.

To use the feature, the monitor needs to be connected to a VESA DPMS compliant computer. There is a power management step the monitor takes as described below. The power management function, including any timer settings is configured by the operating system. Check your operating system manual for information on how this can be configured.

### ■ Power Management Mode

When the H-sync signal / V-sync signal / H and V sync signals from the computer are off, the monitor enters into Power Management Mode which reduces the power consumption to less than 0.5W. The screen becomes dark. From Power Management Mode, the image reappears in several seconds when either the keyboard or the mouse are touched again.

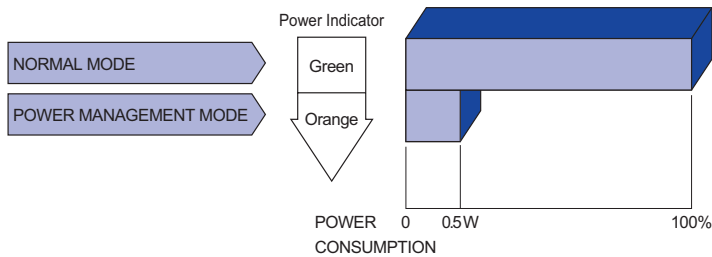

### NOTE

- Even when using the power management mode, the monitor consumes electricity. Turn off the Power Switch whenever the monitor is not in use, during the night and weekends, to avoid unnecessary power consumption.
- It is possible that the video signal from the computer may be on while the H or V sync signal is missing. In this instance, the POWER MANAGEMENT feature may not work properly.

# TROUBLE SHOOTING

If the monitor fails to operate correctly, please follow the steps below for a possible solution.

1. Perform the adjustments described in OPERATING THE MONITOR, depending on the problem you have. If the monitor does not get a picture, skip to 2.
2. Consult the following items if you cannot find an appropriate adjustment item in OPERATING THE MONITOR or if the problem persists.
3. If you are experiencing a problem which is not described below or you cannot correct the problem, discontinue using the monitor and contact your dealer or iiyama service center for further assistance.

<b>Problem</b>	<b>Check</b>
① The picture does not appear.	<input type="checkbox"/> The Power Cable is firmly seated in the socket. <input type="checkbox"/> The Power Switch is turned ON. <input type="checkbox"/> The AC socket is live. Please check with another piece of equipment. <input type="checkbox"/> If the blank screen saver is in active mode, touch the keyboard or the mouse. <input type="checkbox"/> Increase the Contrast and/or Brightness. <input type="checkbox"/> The computer is ON. <input type="checkbox"/> The Signal Cable is properly connected. <input type="checkbox"/> The signal timing of the computer is within the specification of the monitor. <input type="checkbox"/> If the monitor is in power management mode, touch the keyboard or the mouse.
② The screen is not synchronized.	<input type="checkbox"/> The Signal Cable is properly connected. <input type="checkbox"/> The signal timing of the computer is within the specification of the monitor. <input type="checkbox"/> The video output level of the computer is within the specification of the monitor.
③ The screen position is not in the center.	<input type="checkbox"/> The signal timing of the computer is within the specification of the monitor.
④ The screen is too bright or too dark.	<input type="checkbox"/> The video output level of the computer is within the specification of the monitor.
⑤ The screen is shaking.	<input type="checkbox"/> The power voltage is within the specification of the monitor. <input type="checkbox"/> The signal timing of the computer is within the specification of the monitor.
⑥ No sound.	<input type="checkbox"/> The audio equipment (computer etc.) is ON. <input type="checkbox"/> The Audio Cable is properly connected. <input type="checkbox"/> The Volume is turned up. <input type="checkbox"/> The Mute is OFF. <input type="checkbox"/> The audio output level of the audio equipment is within the specification of the monitor.
⑦ The sound is too loud or too quiet.	<input type="checkbox"/> The audio output level of the audio equipment is within the specification of the monitor.
⑧ A strange noise is heard.	<input type="checkbox"/> The Audio Cable is properly connected.
⑨ The touch screen shows no response.	<input type="checkbox"/> The USB Cable is firmly seated in the socket. <input type="checkbox"/> Touch screen driver software is installed.
⑩ The touch position does not deviate.	<input type="checkbox"/> The calibration function set up correctly.

# RECYCLING INFORMATION

For better environment protection please don't dispose your monitor.  
Please visit our web site: [www.iiyama.com/recycle](http://www.iiyama.com/recycle) for monitor recycling.

# APPENDIX

Design and specifications are subject to change without prior notice.

## SPECIFICATIONS

Touch Screen	Technology	Projected Capacitive 50points* <sup>1</sup>
	Light transmission	80% min.
	Hardness	6H
	Thickness	5mm
	Communication system	USB serial transfer
Size Category		65"
LCD Panel	Panel technology	IPS
	Size	Diagonal: 65" (165cm)
	Pixel pitch	0.372mm H × 0.372mm V
	Brightness	500cd/m <sup>2</sup> (Typical: without Touch panel), 400cd/m <sup>2</sup> (Typical: with Touch panel)
	Contrast ratio	1000 : 1 (Typical)
	Viewable angle	Horizontal: 178 degrees, Vertical: 178 degrees (Typical)
	Response time	8ms (Gray to Gray)
Pixel format	3840(H), 2160(V) Pixels, RGBW arrangement	
Display Colors		Approx. 16.7M
Sync Frequency		VGA: 30.0-74.5kHz, Vertical: 47-63Hz DisplayPort: Horizontal: 30.0-135.0kHz, Vertical: 24-30,55-75Hz HDMI1: Horizontal: 30.0-135.0kHz, Vertical: 24-30,55-75Hz HDMI2/3: Horizontal: 30.0-90.0kHz, Vertical: 24-30,55-75Hz
Supported max. resolution		VGA: 1920 × 1080, 60Hz DisplayPort: 3840 × 2160, 60Hz HDMI1/2/3: 3840 × 2160, 60Hz Media Player: 1920 × 1080, 30Hz
Input Connector		VGA, HDMI × 3, DisplayPort
Control Connector		RS-232C
Plug & Play		VESA DDC2B™
Input Sync Signal		Separate sync: TTL, Positive or Negative
Input Video Signal		Analog: 0.7Vp-p (Standard), 75Ω, Positive Digital: HDMI2.0(HDCP1.4)* <sup>4</sup> , DisplayPort1.2
Input Audio Connector		ø 3,5mm mini jack (Stereo)
Input Audio Signal		0.5Vrms maximum
Speakers		8W × 2 (Stereo speakers)
IR Connector		IR Extender
USB Connector		USB2.0 (Media Player)
Maximum Screen Size		1430.4mm W × 805.6mm H / 56.3" W × 31.7" H
Power Source		100-240VAC, 50/60Hz, 1.5A
Power Consumption* <sup>2</sup>		105W typical, Power management mode: 0.5W maximum Energy Efficiency Class: A+
Dimensions / Net Weight		1530.5 × 905.5 × 67.5mm / 60.3 × 35.6 × 2.6" (W×H×D) 60.0kg / 132.3lbs

Environmental Considerations	Operating:	Temperature	0 to 40°C / 32 to 104°F
		Humidity	85% (No condensation)
Approvals	Storage:	Temperature	-20 to 60°C / 4 to 140°F
		Humidity	85% (No condensation)

- NOTE**
- \*1 Windows OS application software have a limited touch pts. (max. 10pts only)
  - \*2 USB peripherals / Audio equipment are not connected.
  - \*3 IPX1 Standard Compliant : Only front face
  - \*4 Not support HDCP2.2.

**DIMENSIONS**

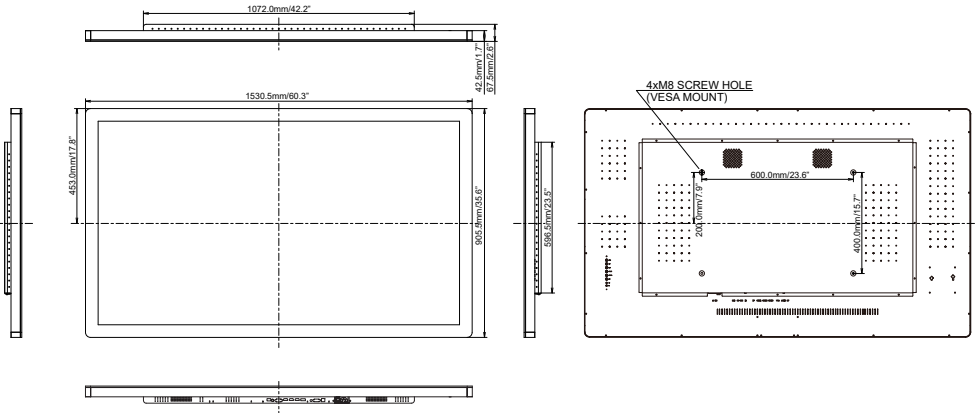



## COMPLIANT TIMING

Video Mode			Horizontal Frequency	Vertical Frequency	Dot Clock
VESA	VGA	640 × 480	31.469kHz	59.940Hz	25.175MHz
	SVGA	800 × 600	37.879kHz	60.317Hz	40.000MHz
	XGA	1024 × 768	48.363kHz	60.004Hz	65.000MHz
	WXGA	1366 × 768	47.712kHz	59.790Hz	85.500MHz
	SXGA	1280 × 1024	63.981kHz	60.020Hz	108.000MHz
	Full HD	1920 × 1080	67.500kHz	60.000Hz	138.500MHz
	WUXGA	1920 × 1200	74.038kHz	59.950Hz	154.000MHz
	WQHD	2560 × 1440	88.787kHz	59.951Hz	241.500MHz
	UHD	3840 × 2160	67.430kHz	29.970Hz	296.700MHz
133.313kHz			59.997Hz	533.250MHz	

\*  
\*  
\*

**NOTE** \* DisplayPort/HDMI input only.