

USER MANUAL

ProLite

LCD Monitor

ENGLISH

ProLite TF3237MSC
ProLite TF4237MSC

Thank you very much for choosing the iiyama LCD monitor.

We recommend that you take a few minutes to read this comprehensive manual carefully before installing and switching on the monitor. Please keep this manual in a safe place for your future reference.

CE MARKING DECLARATION OF CONFORMITY

This LCD monitor complies with the requirements of the EC/EU Directive 2014/30/EU "EMC Directive", 2014/35/EU "Low Voltage Directive" and 2011/65/EU "RoHS Directive".

Warning

This is a class A product. In a domestic environment this product may cause radio interference in which case the user may be required to take adequate measures.

IYAMA CORPORATION: Wijkmeesterstraat 8, 2131 HA Hoofddorp, The Netherlands

Model No. : PL3237 / PL4237



We recommend recycling of used product. Please contact your dealer or iiyama service center. Recycle information is obtained via the Internet, using the address: <http://www.iiyama.com>

You can access the Web page of different countries from there.

- We reserve the right to change specifications without notice.
- All trademarks used in this user manual are the property of their respective owners.

TABLE OF CONTENTS

FOR YOUR SAFETY.....	1
SAFETY PRECAUTIONS.....	1
SPECIAL NOTES ON LCD MONITORS.....	3
CUSTOMER SERVICE.....	4
CLEANING.....	4
BEFORE YOU OPERATE THE MONITOR.....	5
FEATURES.....	5
CHECKING THE CONTENTS OF THE PACKAGE.....	5
UNPACKING : ProLite TF4237MSC.....	6
SPECIAL NOTES ON.....	6
CONTROLS AND CONNECTORS : MONITOR.....	7
INSTALLATION.....	8
CONTROLS AND CONNECTORS :	
REMOTE CONTROL (For maintenance).....	10
PREPARING THE REMOTE CONTROL.....	11
BASIC OPERATION.....	12
CONNECTING YOUR MONITOR.....	15
COMPUTER SETTING.....	16
OPERATING THE MONITOR.....	17
ADJUSTMENT MENU CONTENTS.....	19
SCREEN ADJUSTMENTS.....	24
POWER MANAGEMENT FEATURE.....	27
TROUBLE SHOOTING.....	28
RECYCLING INFORMATION.....	29
APPENDIX.....	30
SPECIFICATIONS : ProLite TF3237MSC.....	30
SPECIFICATIONS : ProLite TF4237MSC.....	31
DIMENSIONS : ProLite TF3237MSC.....	32
DIMENSIONS : ProLite TF4237MSC.....	32
COMPLIANT TIMING.....	33

FOR YOUR SAFETY

SAFETY PRECAUTIONS

WARNING

STOP OPERATING THE MONITOR WHEN YOU SENSE TROUBLE

If you notice any abnormal phenomena such as smoke, strange sounds or fumes, unplug the monitor and contact your dealer or iiyama service center immediately. Further use may be dangerous and can cause fire or electric shock.

NEVER REMOVE THE CABINET

High voltage circuits are inside the monitor. Removing the cabinet may expose you to the danger of fire or electric shock.

DO NOT PUT ANY OBJECT INTO THE MONITOR

Do not put any solid objects or liquids such as water into the monitor. In case of an accident, unplug your monitor immediately and contact your dealer or iiyama service center. Using the monitor with any object inside may cause fire, electric shock or damage.

INSTALL THE MONITOR ON A FLAT, STABLE SURFACE

The monitor may cause an injury if it falls or is dropped.

DO NOT USE THE MONITOR NEAR WATER

Do not use where water may be splashed or spilt onto the monitor as it may cause fire or electric shock.

OPERATE UNDER THE SPECIFIED POWER SUPPLY

Be sure to operate the monitor only with the specified power supply. Use of an incorrect voltage will cause malfunction and may cause fire or electric shock.

PROTECT THE CABLES

Do not pull or bend the power cable and signal cable. Do not place the monitor or any other heavy objects on the cables. If damaged, the cables may cause fire or electric shock.

ADVERSE WEATHER CONDITIONS

It is advisable not to operate the monitor during a heavy thunder storm as the continual breaks in power may cause malfunction. It is also advised not to touch the plug in these circumstances as it may cause electric shock.

CAUTION

INSTALLATION LOCATION

Do not install the monitor where sudden temperature changes may occur, or in humid, dusty or smoky areas as it may cause fire, electric shock or damage. You should also avoid areas where the sun shines directly on the monitor.

DO NOT PLACE THE MONITOR IN A HAZARDOUS POSITION

The monitor may topple and cause injury if not suitably located. Please also ensure that you do not place any heavy objects on the monitor, and that all cables are routed such that children may not pull the cables and possibly cause injury.

MAINTAIN GOOD VENTILATION

Ventilation slots are provided to keep the monitor from overheating. Covering the slots may cause fire. To allow adequate air circulation, place the monitor at least 10 cm (or 4 inches) from any walls.

Do not remove the tilt stand when operating the monitor. Ventilation slots on the back of the cabinet will be blocked and the monitor may overheat if the stand is removed. This may cause fire or damage. Operating the monitor on its back, side, upside down or on a carpet or any other soft material may also cause damage.

DISCONNECT THE CABLES WHEN YOU MOVE THE MONITOR

When you move the monitor, turn off the power switch, unplug the monitor and be sure the signal cable is disconnected. If you do not disconnect them, it may cause fire or electric shock.

UNPLUG THE MONITOR

If the monitor is not in use for a long period of time it is recommended that it is left unplugged to avoid accidents.

HOLD THE PLUG WHEN DISCONNECTING

To disconnect the power cable or signal cable, always pull it by the plug. Never pull on the cable itself as this may cause fire or electric shock.

DO NOT TOUCH THE PLUG WITH WET HANDS

Pulling or inserting the plug with wet hands may cause electric shock.

WHEN YOU INSTALL THE MONITOR ON YOUR COMPUTER

Be sure the computer is strong enough to hold the weight of the monitor, otherwise, you may damage your computer.

REMARK FOR 24/7 USAGE

This product is not specifically designed for 24/7 usage in all environments.

OTHERS

ERGONOMIC RECOMMENDATIONS

To eliminate eye fatigue, do not operate the monitor against a bright background or in a dark room. For optimal viewing comfort, the monitor should be just below eye level and 40-60 cm (16-24 inches) away from your eyes. When using the monitor over a prolonged time, a ten minute break every hour is recommended as looking at the screen continuously can cause eye strain.

SPECIAL NOTES ON LCD MONITORS

The following symptoms are normal with LCD monitors and do not indicate a problem.

NOTE

- When you first turn on the LCD monitor, the picture may not fit in the display area because of the type of computer that is used. In this case, adjust the picture position to the correct position.
- You may find slightly uneven brightness on the screen depending on the desktop pattern you use.
- Due to the nature of the LCD screen, an afterimage of the previous screen may remain after switching the image, when the same image is displayed for hours. In this case, the screen is recovered slowly by changing the image or turning off the Power Switch for hours.
- Max. non-stop operating time and conditions
 - (1) If a static image is displayed continuously, it is recommended to disrupt it with a motion picture.
 - (2) It is recommended to periodically change the background colour and background image.
 - (3) Maximum operating time of the display is 20 hours per day, if the Anti Image Retention is set on. If the Anti Image Retention is off, do not exceed a 12 hour non-stop operating time limit.
 - (4) If the screen is active for a longer period of time, it is recommended to
 - I. Run the screensaver (motion picture or black pattern)
 - II. Power off the system for a while
 - (5) Make sure that the screen is suitably ventilated, or is used in conjunction with climate control system if installed into any bespoke cabinets.
 - (6) We strongly recommend an active cooling system with fans for long operating times, especially for high luminance LCD models.
- This LCD cannot be used outdoors.
- If you use a cable longer than the supplied one, the picture quality is not guaranteed. Touch function can be disrupted if the USB cable length exceeds 3m.

CUSTOMER SERVICE

NOTE

- If you have to return your unit for service and the original packaging has been discarded, please contact your dealer or iiyama service center for advice or replacement packaging.

CLEANING

WARNING

- If you drop any materials or liquids such as water into the monitor when cleaning, unplug the power cable immediately and contact your dealer or iiyama service center.

CAUTION

- For safety reasons, turn off the power switch and unplug the monitor before you clean it.

NOTE

- To protect the LCD panel, do not scratch or rub the screen with a hard object.
- Never use any of the following strong solvents. These will damage the cabinet and the LCD screen.

Thinner

Benzine

Abrasive cleaner

Spray-type cleaner

Wax

Acid or Alkaline solvent

- Touching the cabinet with any product made from rubber or plastic for a long time may cause degeneration or loss of paint on the cabinet.

CABINET

Stains can be removed with a cloth lightly moistened with a mild detergent solvent. Then wipe the cabinet with a soft dry cloth.

LCD

Periodic cleaning with a soft dry cloth is recommended.

SCREEN

Don't use tissue paper etc. because these will damage the LCD screen.

BEFORE YOU OPERATE THE MONITOR

FEATURES

- ◆ Supports Resolutions up to 1920 × 1080
- ◆ High Contrast 3000:1 (Typical) / Brightness 500cd/m² (Typical: without Touch panel): ProLite TF3237MSC
- ◆ High Contrast 1000:1 (Typical) / Brightness 400cd/m² (Typical: without Touch panel): ProLite TF4237MSC
- ◆ Digital Character Smoothing
- ◆ Automatic Set-up
- ◆ Stereo Speakers
2 × 7W Stereo Speakers
- ◆ Plug & Play VESA DDC2B Compliant
Windows[®] XP/Vista/7/8/8.1/10 Compliant
- ◆ Power Management (VESA DPMS Compliant)
- ◆ VESA Mounting Standard (400mm×200mm) Compliant
- ◆ IPX1 Standard Compliant (Only front face)

CHECKING THE CONTENTS OF THE PACKAGE

The following accessories are included in your package. Check to see if they are enclosed with the monitor. If anything is missing or damaged, please contact your local iiyama dealer or regional iiyama office.

- Power Cable*
- USB Cable
- Remote Control (For maintenance)
- Clamper (For tying cables)
- VGA(D-sub) Signal Cable
- IR Extender Cable
- DVI-D Signal Cable
- IR Extender Cable
- Button Battery CR2025 (for Remote Control)
- Safety Guide
- Quick Start Guide

CAUTION * The rating of the Power Cable enclosed in 120V area is 10A/125V. If you are using a power supply higher than this rating, then a power cable with a rating of 10A/250V must be used. However, all guarantees and warranties are void for any problems or damage caused by a power cable not supplied by iiyama.

UNPACKING : ProLite TF4237MSC

- ① Before unpacking your monitor, prepare a stable, level, and clean surface near a wall outlet. Set the LCD Monitor box in an upright position and open from the top of the box before removing the top cushions.
- ② Remove the carton holders.
- ③ Remove the top cushion and take the accessories box and the Monitor out.

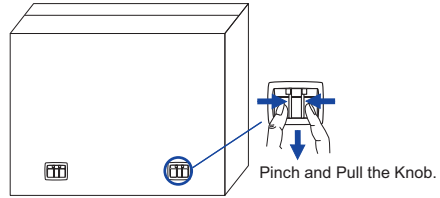

CAUTION

Moving the monitor requires at least two people. If not, it may drop and could result in a serious injury.
When moving/shipping the monitor, please hold by the carton holders.

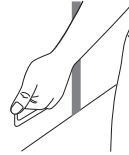

SPECIAL NOTES ON

CAUTION

Permanent damage can occur if Sharp Edged, Pointed or Metal items are used to activate Touch. This could invalidate any remaining warranty.
We recommend you use a plastic stylus (tip R0.8 or over) or finger.

CONTROLS AND CONNECTORS : MONITOR

<Front>

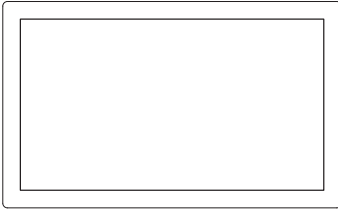

<Back>

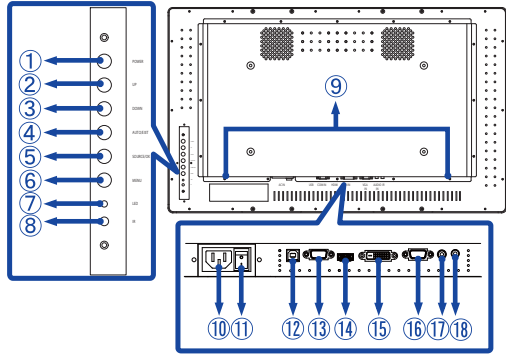

①	POWER	Power Button	
②	UP	Up/Volume + Button	
③	DOWN	Down/Volume - Button	
④	AUTO / EXIT	Auto/Exit Button	
⑤	SOURCE / OK	Input Select/OK Button	
⑥	MENU	Menu Button	
⑦	LED	Green	Normal Operation
		Orange	Power Management
⑧	IR	Remote Sensor	
⑨	SPEAKERS	Speakers	
⑩	AC IN	AC-INLET	AC Connector(~ : Alternating current) (AC-IN)
⑪	AC SWITCH (ON) / ○ (OFF)	MAIN POWER	Main Power Switch
⑫	USB	USB	Touch USB Connector
⑬	COM IN	D-SUB 9pin	RS232C Connector
⑭	HDMI	HDMI	HDMI Connector
⑮	DVI IN	DVI-D 24pin	DVI-D 24pin Connector
⑯	VGA IN	D-SUB mini 15pin	VGA(D-sub) mini 15pin Connector
⑰	AUDIO IN (PC Audio In)	Mini Jack	Audio Connector
⑱	IR	Mini Jack	IR Extender Connector

INSTALLATION

CAUTION

- Follow the manual instructions for the type of mount you have selected. Refer all servicing to qualified service personnel.
- Moving the monitor requires at least two people.
- Before installing, please make sure the wall is strong enough to hold the necessary weight of the display and the mount.

[WALL MOUNTING]

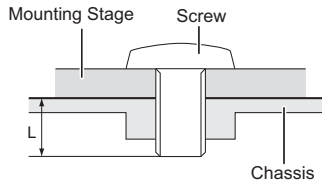

CAUTION

When using the wall mounting, consideration of thickness of the mounting stage needs to be taken. Tighten the M6 Screw with washer which “L” length is 20mm(VESA mounting holes) or 5.5mm(Outer mounting holes) to fasten the monitor. Using a screw longer than this may cause electric shock or damage because it may contact with the electrical parts inside the monitor.

[FAN]

CAUTION

If the screen is used in face-up position, please be sure to turn on the FAN function. If you do not use the FAN, the internal temperature rises and the product life cycle may get shorter. If the screen is built into an external cabinet, please be sure to implement a cooling unit inside of the cabinet. Dirt and dust may stick to the FAN, reducing the cooling effect which may result in a shorter life cycle of the product. Please clean regularly.

[ROTATING THE DISPLAY]

It is designed to be compatible in both landscape and portrait modes, however, it is optimized for landscape mode.

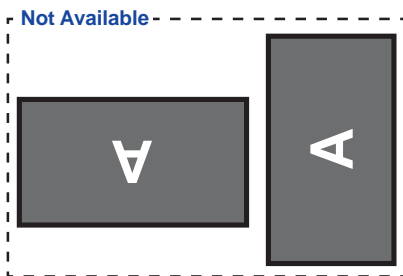
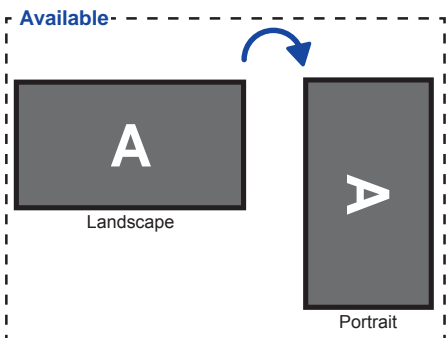

CONTROLS AND CONNECTORS : REMOTE CONTROL (For maintenance)

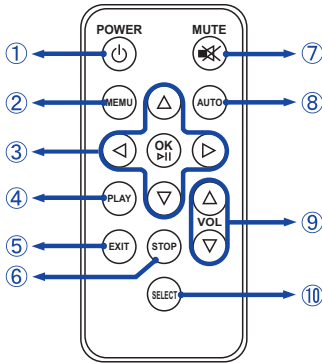

NOTE

To use the remote control we advise you to position it at the back of the monitor (left side) where the remote sensor is located. It might not work if you use it standing in front of the monitor.

①	POWER	Turns the monitor ON and OFF.
②	MENU	Opens the monitor's on-screen menu systems. When the menu system is already open, pressing this button will select the previous submenu.
③	▲▼◀▶	Navigates through submenus and settings. ▲: Up Button ▼: Down Button ◀: Left Button ▶: Right Button
	OK	Confirms your selection or save changes.
④	PLAY	Not available on this model.
⑤	EXIT	Returns to a previous menu or closes the OSD Menu.
⑥	STOP	Not available on this model.
⑦	MUTE	Turns on or off the mute function when the Menu is not displayed.
⑧	AUTO	Adjust H. / V. Position, Clock and Phase automatically.
⑨	VOL	▲: Increases the sound volume. ▼: Decreases the sound volume.
⑩	SELECT	Selects the source.

PREPARING THE REMOTE CONTROL

To use the remote control, insert the button battery.

CAUTION

Do not use any other batteries other than those specified in this manual for the Remote Control. Burst batteries or the electrolyte from these batteries may cause stains, fire or injury.

① Push Lock to right and remove the battery case in the direction of the arrow.

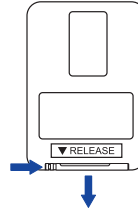

② Put it in face up the + side of the button battery (CR2025).

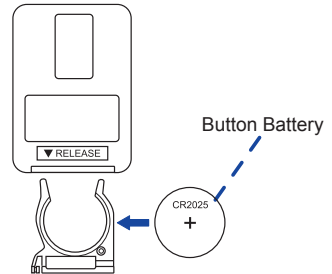

③ Replace the battery case in the direction of the arrow.

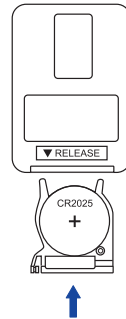

NOTE

- Replace with new batteries when the Remote Control does not work close to the monitor. Use the button battery (CR2025).
- Other manufacturers remote control will not work with this monitor. Use the provided Remote Control ONLY.
- Used batteries needed to follow the local rules to be discarded. (Suggestion: to dispose of used batteries please follow correct policy as per your local regulations.)

BASIC OPERATION

■ Turning the monitor ON

The monitor is on and the Power Indicator turns Green when you press the Power Button on the monitor or the Remote Control. The monitor is off and the Power Indicator turns Orange when you press the Power Button on the monitor or the Remote Control. Press again to turn the monitor on.

NOTE

Even when using the power management mode or turning OFF the Power Switch, the monitor will consume a small amount of electricity. Disconnect the Power Cable from the power supply whenever the monitor is not in use or during the night, to avoid unnecessary power consumption.

[Monitor]

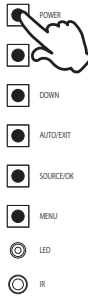

[Remote Control]



■ Display the adjustment menu page

The menu page appears on the screen when you press the MENU Button on the monitor or the Remote Control.

The menu page disappears when you press the EXIT Button on the Monitor or the Remote Control.

[Monitor]

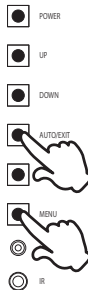

[Remote Control]

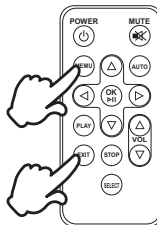

■ Move the cursor vertically

Select adjustment by pressing the UP / DOWN Button on the monitor or the ▲ / ▼ Button on the Remote Control while the menu page is displayed on the screen.

[Monitor]

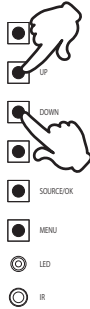

[Remote Control]

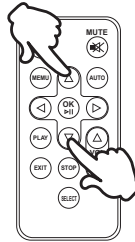

■ Move the cursor horizontally

Select menu or setting, or perform the adjustment by pressing the ◀ / ▶ Button on the Remote Control while the menu page is displayed on the screen.

[Remote Control]

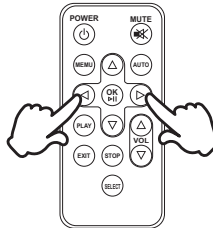

■ Adjust the volume of sound

Press the UP / DOWN Button on the Monitor or the VOL ▲ / ▼ Button on the Remote Control to adjust the volume of sound when the menu page is not displayed on the screen.

[Monitor]

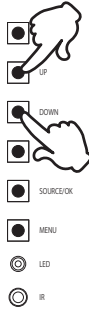

[Remote Control]



■ Switch the input signal

This is activated when you successively press the SOURCE Button on the monitor or SELECT Button on the Remote Control.

[Monitor]

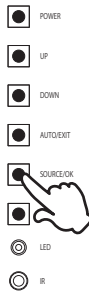

[Remote Control]

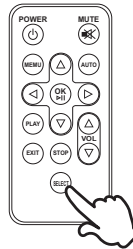

CONNECTING YOUR MONITOR

- ① Ensure that both the computer and the monitor are switched off.
- ② Connect the computer to the monitor with the signal cable.
- ③ Connect the computer to the monitor with the USB Cable.
- ④ Connect the Power Cable to the monitor first and then to the power supply.
- ⑤ Turn on your monitor (Main Power Switch and Power Switch) and computer.

- NOTE**
- The signal cables used for connecting the computer and monitor may vary with the type of computer used. An incorrect connection may cause serious damage to both the monitor and the computer. The cable supplied with the monitor is for a standard connector. If a special cable is required please contact your local iiyama dealer or regional iiyama office.
 - Make sure you tighten the finger screws at each end of the Signal Cable.
 - Don't connect the RS-232C cable and the USB cable to the computer at the same time. And cannot use those at the same time.
 - When USB cable connected than wait for 5 seconds and the touch function is ready to go. It can be activated by pen, finger or any other pointer.

[Example of Connection]

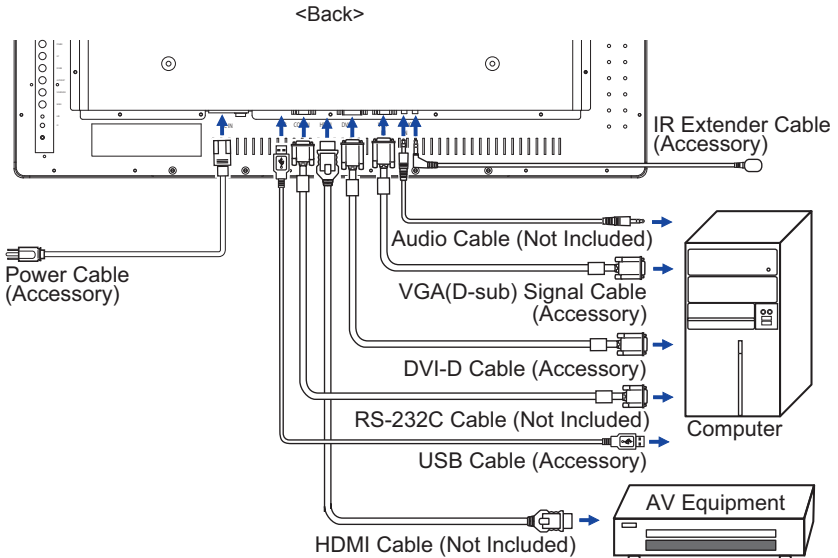

[Collect Cables]

- ① Insert the Clamper into the Hole.
- ② Collect cables at the back.
- ③ Secure the cables using a clamper.

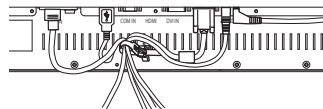

COMPUTER SETTING

■ Signal Timing

Change to the desired signal timing listed on page 33: COMPLIANT TIMING.

■ Windows XP/Vista/7/8/8,1/10 Plug & Play

The iiyama LCD monitor complies with DDC2B of VESA standard. The Plug & Play function runs on Windows XP/Vista/7/8/8,1/10 by connecting the monitor to DDC2B compliant computer with the Signal Cable supplied.

For installation on Windows XP: The monitor Information File for iiyama monitors may be necessary for your computer and obtained via the Internet, using the address:

<http://www.iiyama.com>

NOTE

- For additional information on how to download the driver for your touch screen monitor, please access the internet site noted above.

■ Procedure for turning ON the Power Switch

Turn ON the monitor first, and then the computer.

■ MULTI-TOUCH

This monitor complies with DDC2B of VESA standard. (Plug&play compliant)

The MULTI-TOUCH function runs on Windows7/8/8,1/10 by connecting the monitor to DDC2B compliant computer with the USB cable supplied.

■ MULTI-TOUCH support operation system

Microsoft Windows 7 (64 bit and 32 bit)

Microsoft Windows 8/8,1/10 (64 bit and 32 bit)

Linux (3.0x) & above

Not support Windows 2000 and earlier versions.

	Windows8/8,1/10	Windows7*5	Windows7*4	Linux
Default mouse*1	○	○	○	○
Touch digitizer*2	○	○	○	×
Windows7 gestures*3	○	○	×	×

*1 Default mouse (click, drag, double-click and right-click)

*2 Touch digitizer (click, drag /selection, double-click, right-click, flick and visual feedback)

*3 Digitizer with Windows7 multi-touch gestures

*4 Windows 7 - Starter and Home Basic version

*5 Windows 7 - Home Premium, Professional, Enterprise and Ultimate versions

OPERATING THE MONITOR

To create the best picture, your iiyama LCD monitor has been preset at the factory with the COMPLIANT TIMING shown on page 33. You are also able to adjust the picture by following the button operation shown below. For more detailed adjustments, see page 24 for SCREEN ADJUSTMENTS.

- 1 Press the MENU Button to start the On Screen Display feature. There are additional Menu items which can be switched by using the ▲ / ▼ Buttons.



- 2 Select the Menu item of the adjustment you want to make. Press the ► or OK Buttons and enter the menu page. Then, use the ▲ / ▼ Buttons to highlight the desired adjustment item.
- 3 Press the ► or OK Buttons again. Use the ▲ / ▼ Buttons to make the appropriate adjustment or setting.
- 4 Press the EXIT Button to leave the menu, and the settings you just made would be automatically saved.

For example, to correct for vertical position, select Menu item of "Display Settings". Select "V. Position" by using the ▲ / ▼ Buttons. Press the ► or OK Buttons. Use the ▲ / ▼ Buttons to change the vertical position settings. The vertical position of the overall display should be changing accordingly while you are doing this.

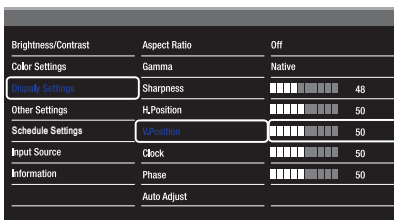

Press the EXIT Button lastly, it ends, all changes are saved in the memory.

NOTE

- When button operations are aborted during adjustment, On-Screen Display disappears when the time set for the OSD Timeout has passed.
- The MENU / EXIT Button can be used to return previous menu item.
- Any changes are automatically saved in the memory when the On Screen Display disappears. Turning off the power should be avoided while using the Menu.
- Adjustments for Image H./V.Position, Clock and Phase are saved for each signal timing. Except for these adjustments, all other adjustments have only one setting which applies to all signal timings.

● **LOCK MODE:** * Available for Back Controller only.

Pressing and holding the MENU button and the Power Switch for about 3 seconds when the Menu is not displayed.

* The OSD menu is not displayed when the OSD is locked. Pressing and holding the MENU button and the Power Switch for about 3 seconds when the Menu is not displayed.

The following OSD menu is displayed.

Adjustment Item	Problem / Option	
OSD	On	The OSD menu is Locked.
	Off	The OSD menu is Unlocked.
Power Key	On	The POWER SWITCH is Locked.
	Off	The POWER SWITCH is Unlocked.
Remoto Control	On	The Remote Control is Locked.
	Off	The Remote Control is Unlocked.

● **PALM REJECTION FUNCTION:**

Palm rejection is a way to disregard signal from finger while using the pen mode.

When you touch the screen with a pen, palm rejection is activated and the screen does not recognize touch made with the finger.

If the screen is not touched with a pen for 1 second, it will automatically return to the finger mode.

NOTE

The screen works only with conductive pens with Φ 4-5mm diameter.

The touch panel does not recognize pens with smaller or large diameter.

Touch made by a pen is not recognized within 15mm distance from edge of the active display area.

ADJUSTMENT MENU CONTENTS

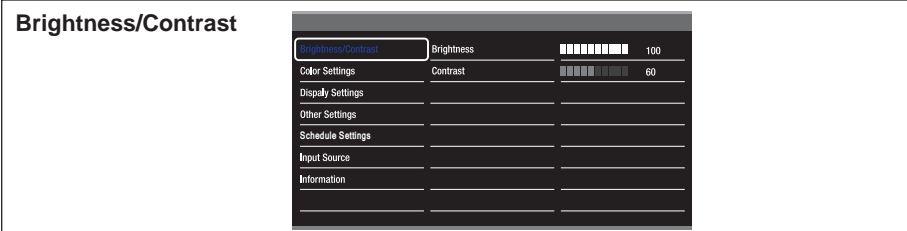

Adjustment Item	Problem / Option	Button to Press
Brightness *	Too dark	← ▲
	Too bright	→ ▼
Contrast	Too dull	← ▲
	Too intense	→ ▼

* Adjust the Brightness when you are using the monitor in a dark room and feel the screen is too bright.

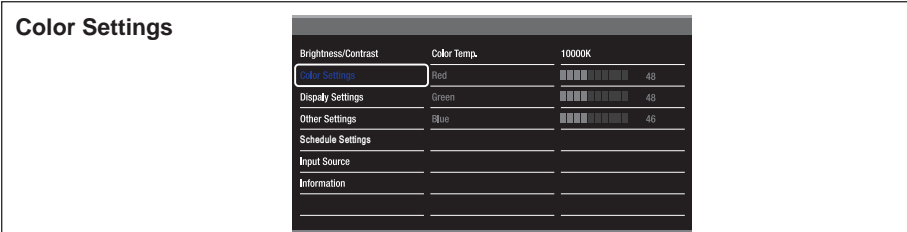

Adjustment Item	Problem / Option	Button to Press	
Color Temp.	10000k	More bluish white	
	9300k	Bluish white	
	6500k	Reddish white	
	USER	RED	Too weak Too strong
		GREEN	
	BLUE	← ▲ → ▼	

Display Settings

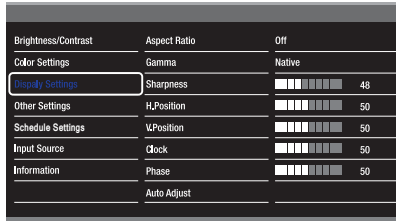

Adjustment Item	Problem / Option	Button to Press
Aspect Ratio	Off	Aspect Ratio is turned off.
	16:10	Displays all picture in 16:10 aspect ratio.
	5:4	Displays all picture in 5:4 aspect ratio.
	4:3	Displays all picture in 4:3 aspect ratio.
Gamma	You can set the Gamma. Native / 2.2 / 1.8	
Sharpness	You can change the picture quality from 0 to 100 (soft to sharp). Press the ▲ Button to change the picture quality in numerical order. Press the ▼ Button to change the picture quality in reverse numerical order.	
H. Position * ¹	Too left	← ▲
	Too right	→ ▼
V. Position * ¹	Too low	← ▲
	Too high	→ ▼
Clock * ^{1,3}	Too narrow	← ▲
	Too wide	→ ▼
Phase * ^{1,3}	To correct flickering text or lines	
Auto Adjust * ^{1,2}	Adjust H./V. Position, Clock and Phase automatically.	





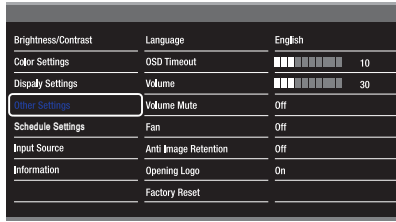

*¹ Only Analog input.

*² For best results, use the Auto Adjust in conjunction with the adjustment pattern. See page 24 for SCREEN ADJUSTMENTS.

*³ See page 24 for SCREEN ADJUSTMENTS.

Other Settings



Adjustment Item	Problem / Option			Button to Press
Language	English	English	Nederlands	Dutch
	Français	French	Poliski	Polish
	Español	Spanish	Русский	Russian
	Deutsch	German	Italiano	Italian
OSD time out	You can set the OSD display duration time between 5 and 30 seconds.			  
Volume	Too soft			
	Too loud			  
Mute	On	Turn off the sound temporarily.		
	Off	Return the sound volume to the previous level.		
Fan * ¹	On	Fan is turned on.		
	Off	Fan is turned off.		
Anti Image Retention	On	Automatically displays moving patterns (shifting by 2 pixels) to prevent image retention on the screen.		
	Off	Anti Image Retention is turned off.		
Opening Logo	On	iiyama Logo displayed when the monitor is turned on.		
	Off	iiyama Logo does not display when the monitor is turned on.		
Factory Reset * ²	Factory-preset data is restored.			

*¹ If the screen is used in face-up position, please be sure to turn on the FAN function.

*² When the Factory Reset is being performed, the Schedule Settings will also be reset.

Schedule Settings

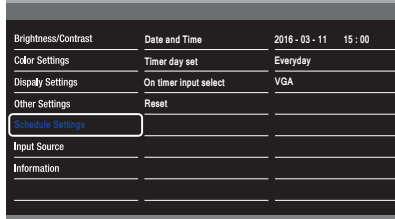

Adjustment Item	Problem / Option		Button to Press
Date and Time	Adjust the current date and time for the internal clock. Date / Time		
Timer day set *	Sets a recurring schedule. Everyday / Sun / Mon / Tue / Wed / Thu / Fri / Sat		
	Activation	On	Schedule is turned on.
		Off	Schedule is turned off.
On Time Off Time	Set the time for the display to turn on and turn off.		
On timer input select	Select default input source to use when the display is automatically turned on next time. VGA / DVI / HDMI		
Reset	On	Schedule Settings will be restored to factory-preset data.	
	Off	Return to Menu.	

* To activate the option, mark it in the setup menu. To deactivate it, remove the marking.

Input Source

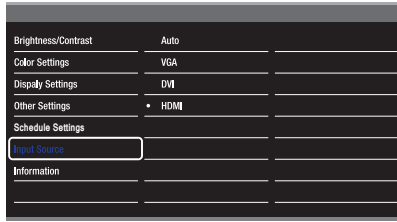

Adjustment Item	Problem / Option	Button to Press
Input Source	AUTO	Select the signal input automatically.
	VGA	Select the analog input.
	DVI	Select the digital(DVI) input.
	HDMI	Select the digital(HDMI) input.

NOTE When only one of the three signal inputs is connected to the signal source, the one connected is automatically selected. Input Source function is not available if there is no signal input from the selected connector or during the power management mode.

Information

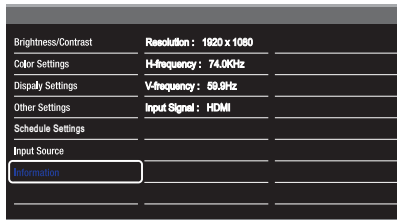

Displays information regarding the current input signal coming from the graphic card in your computer.

NOTE See your graphic card user guide for more information about changing the resolution and refresh.

SCREEN ADJUSTMENTS

Adjust the image by following the procedure below to get the desired picture when selecting Analog input.

- The screen adjustments described in this manual are designed to set image position and minimize flicker or blur for the particular computer in use.
- The monitor is designed to provide the best performance at resolution of 1920 × 1080, but can not provide the best at resolutions of less than 1920 × 1080 because the picture is automatically stretched to fit the full screen. It is recommended to operate at resolution of 1920 × 1080 in normal use.
- Displayed text or lines will be blurred or irregular in thickness when the picture is stretched due to the screen enlargement process.
- It is preferable to adjust the image position and frequency with the monitor controls, rather than the computer software or utilities.
- Perform adjustments after a warm-up period of at least thirty minutes.
- Additional adjustments may be required after the Auto Adjust depending on the resolution or signal timing.
- The Auto Adjust may not work correctly when displaying the picture other than the screen adjustment pattern. In this case, manual adjustments are required.

There are two ways to adjust the screen. One way is automatic adjustment for Position, Clock and Phase. The other way is performing each adjustment manually.

Perform the Auto Adjust first when the monitor is connected to a new computer, or resolution is changed. If the screen has a flicker or blur, or the picture does not fit in the display area after performing the Auto Adjust, manual adjustments are required. Both adjustments should be made by using the screen adjustment pattern (Test.bmp) obtained via the Iiyama web site (<http://www.iiyama.com>).

Adjust the image by following the procedure below to get the desired picture.

This manual explains adjustment under Windows® OS.

- ① **Display the picture at the optimum resolution.**
- ② **Enter the Test.bmp (screen adjustment pattern) to wallpaper.**

NOTE

- Consult the appropriate documentation for doing this.
- Test.bmp is made at resolution of 1280 × 1024. Set the display position to center in the wallpaper setting dialogue box. If you use Microsoft® PLUS! 95/98 cancel the setting of "Stretch desktop wallpaper to fit the screen".

[Adjustment pattern]

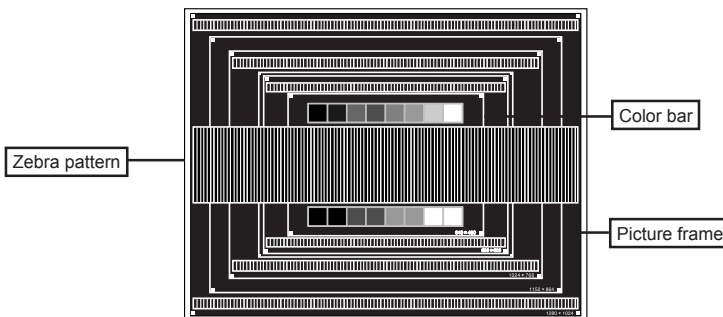

- ③ Adjust the Auto Adjustment.
- ④ Adjust the image manually by following procedure below when the screen has a flicker or blur, or the picture does not fit in the display area after performing the Auto Adjust.
- ⑤ Adjust the V-Position so that the top and bottom of the picture frame will fit to the display area.

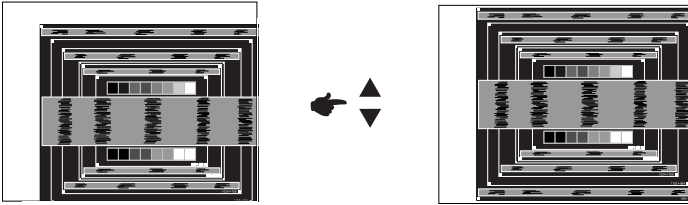

- ⑥ 1) Adjust the H-Position so that the left side of the picture frame will move to the left edge of the display area.

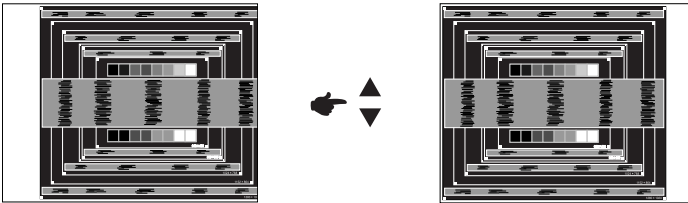

- 2) Stretch the right side of the picture frame to the right edge of the display area by adjusting the Clock.

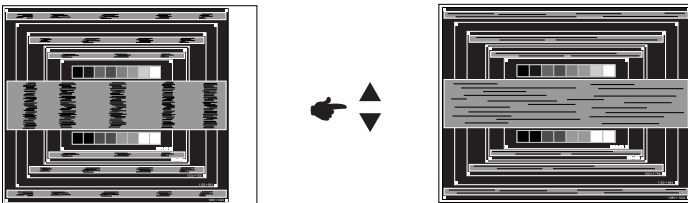
**NOTE**

- When the left side of the picture frame moves apart from the left edge of the display area during the Clock adjustment, adjust steps 1) and 2).
- Another way to make the Clock adjustment is to correct the vertical wavy lines in the zebra pattern.
- The picture may flicker during the Clock, H/V-Position adjustment.
- In case the picture frame is bigger or smaller than the data display area after the Clock adjustment, repeat steps from ③.

- ⑦ Adjust the Phase to correct horizontal wavy noise, flicker or blur in the zebra pattern.

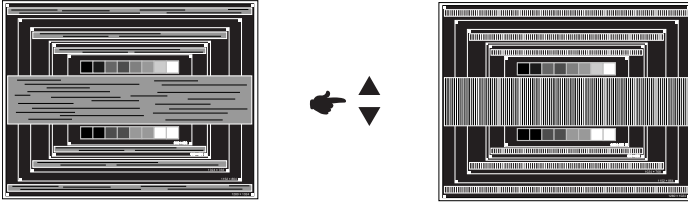
**NOTE**

- In case the strong flicker or blurs remain on a part of the screen, repeat steps ⑥ and ⑦ because the Clock may not be adjusted correctly. If the flicker or blurs still remain, set the refresh rate of computer to low (60Hz) and repeat steps from ③ again.
- Adjust the H-Position after the Phase adjustment if the horizontal position moves during the adjustment.

- ⑧ Adjust the Brightness and Color to get the desired picture after you complete the Clock and Phase adjustments.

Put back your favorite wallpaper.

POWER MANAGEMENT FEATURE

The power management feature of this product complies with power saving requirement of VESA DPMS. When activated, it automatically reduces unnecessary power consumption of the monitor when your computer is not in use.

To use the feature, the monitor needs to be connected to a VESA DPMS compliant computer. There is a power management step the monitor takes as described below. The power management function, including any timer settings is configured by the operating system. Check your operating system manual for information on how this can be configured.

■ Power Management Mode

When the H-sync signal / V-sync signal / H and V sync signals from the computer are off, the monitor enters into Power Management Mode which reduces the power consumption to less than 0.5W. The screen becomes dark. From Power Management Mode, the image reappears in several seconds when either the keyboard or the mouse are touched again.

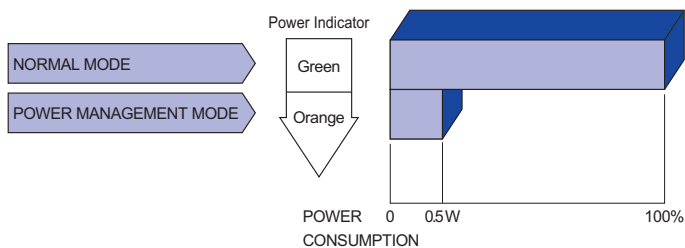

NOTE

- Even when using the power management mode, the monitor consumes electricity. Turn off the Power Switch whenever the monitor is not in use, during the night and weekends, to avoid unnecessary power consumption.
- It is possible that the video signal from the computer may be on while the H or V sync signal is missing. In this instance, the POWER MANAGEMENT feature may not work properly.

TROUBLE SHOOTING

If the monitor fails to operate correctly, please follow the steps below for a possible solution.

1. Perform the adjustments described in OPERATING THE MONITOR, depending on the problem you have. If the monitor does not get a picture, skip to 2.
2. Consult the following items if you cannot find an appropriate adjustment item in OPERATING THE MONITOR or if the problem persists.
3. If you are experiencing a problem which is not described below or you cannot correct the problem, discontinue using the monitor and contact your dealer or iiyama service center for further assistance.

Problem	Check
① The picture does not appear.	<input type="checkbox"/> The Power Cable is firmly seated in the socket. <input type="checkbox"/> The Power Switch is turned ON. <input type="checkbox"/> The AC socket is live. Please check with another piece of equipment. <input type="checkbox"/> If the blank screen saver is in active mode, touch the keyboard or the mouse. <input type="checkbox"/> Increase the Contrast and/or Brightness. <input type="checkbox"/> The computer is ON. <input type="checkbox"/> The Signal Cable is properly connected. <input type="checkbox"/> The signal timing of the computer is within the specification of the monitor. <input type="checkbox"/> If the monitor is in power management mode, touch the keyboard or the mouse.
② The screen is not synchronized.	<input type="checkbox"/> The Signal Cable is properly connected. <input type="checkbox"/> The signal timing of the computer is within the specification of the monitor. <input type="checkbox"/> The video output level of the computer is within the specification of the monitor.
③ The screen position is not in the center.	<input type="checkbox"/> The signal timing of the computer is within the specification of the monitor.
④ The screen is too bright or too dark.	<input type="checkbox"/> The video output level of the computer is within the specification of the monitor.
⑤ The screen is shaking.	<input type="checkbox"/> The power voltage is within the specification of the monitor. <input type="checkbox"/> The signal timing of the computer is within the specification of the monitor.
⑥ No sound.	<input type="checkbox"/> The audio equipment (computer etc.) is ON. <input type="checkbox"/> The Audio Cable is properly connected. <input type="checkbox"/> The Volume is turned up. <input type="checkbox"/> The Mute is OFF. <input type="checkbox"/> The audio output level of the audio equipment is within the specification of the monitor.
⑦ The sound is too loud or too quiet.	<input type="checkbox"/> The audio output level of the audio equipment is within the specification of the monitor.
⑧ A strange noise is heard.	<input type="checkbox"/> The Audio Cable is properly connected.
⑨ The touch screen shows no response.	<input type="checkbox"/> The RS-232C or USB Cable is firmly seated in the socket. <input type="checkbox"/> Touch screen driver software is installed.
⑩ The touch position does not deviate.	<input type="checkbox"/> The calibration function set up correctly.

RECYCLING INFORMATION

For better environment protection please don't dispose your monitor.
Please visit our web site: www.iiyama.com/recycle for monitor recycling.

APPENDIX

Design and specifications are subject to change without prior notice.

SPECIFICATIONS : ProLite TF3237MSC

ENGLISH

Touch Screen	Technology	Projected Capacitive 12points
	Light transmission	84%
	Communication system	USB serial transfer
Size Category		32"
LCD Panel	Panel technology	MVA
	Size	Diagonal: 31.5" (80cm)
	Pixel pitch	0.364mm H × 0.364mm V
	Brightness	500cd/m ² (Typical: without Touch panel), 420cd/m ² (Typical: with Touch panel)
	Contrast ratio	3000 : 1 (Typical)
	Viewable angle	Horizontal : 178 degrees, Vertical: 178 degrees (Typical)
	Response time	8ms (Gray to Gray)
Display Colors		Approx.16.7M
Sync Frequency		Analog: Horizontal: 31.47-67.50kHz, Vertical: 47-63Hz Digital: Horizontal: 15.62-67.50kHz, Vertical: 24-60Hz
Maximum Resolution		1920 × 1080, 2.1 MegaPixels
Input Connector		VGA(D-sub) mini 15 pin, DVI-D 24 pin, HDMI
Input Audio Connector		ø 3,5mm mini jack (Stereo)
Serial Port		RS-232C
Plug & Play		VESA DDC2B™
Input Sync Signal		Separate sync: TTL, Positive or Negative
Input Video Signal		Analog: 0.7Vp-p (Standard), 75Ω, Positive Digital: DVI (Digital Visual Interface Standard Rev.1.0) compliance Digital: HDMI
Input Audio Signal		1.0Vrms maximum
Speakers		7W×2 (Stereo speakers)
IR Connector		IR Extender
Maximum Screen Size		698.4mm W × 392.8mm H / 27.5" W × 15.5"
Power Source		100-240VAC, 50/60Hz, 0.6A
Power Consumption*1		48W typical, Power management mode: 0.5W maximum Energy Efficiency Class: B
Dimensions / Net Weight		781.5 × 476.0 × 69.0mm / 30.8 × 18.7 × 2.7" (W×H×D) 17.3kg / 38.1lbs
Environmental Considerations		Operating: Temperature 0 to 40°C / 32 to 104°F Humidity 85% (No condensation) Storage: Temperature -20 to 60°C / 4 to 140°F Humidity 85% (No condensation)
Approvals		CE, TÜV-Bauart, CU, IPX1*2

NOTE *1 USB peripherals / Audio equipment are not connected.

*2 IPX1 Standard Compliant : Only front face

SPECIFICATIONS : ProLite TF4237MSC

Touch	Technology	Projected Capacitive 12points
Screen	Light transmission	84%
	Communication system	USB serial transfer
Size Category		42"
LCD Panel	Panel technology	IPS
	Size	Diagonal: 42" (106.5cm)
	Pixel pitch	0.4833mm H × 0.4833mm V
	Brightness	400cd/m ² (Typical: without Touch panel), 340cd/m ² (Typical: with Touch panel)
	Contrast ratio	1000 : 1 (Typical)
	Viewable angle	Horizontal : 178 degrees, Vertical: 178 degrees (Typical)
	Response time	6ms (Typical)
Display Colors		Approx.16.7M
Sync Frequency		Analog: Horizontal: 31.47-67.50kHz, Vertical: 47-63Hz Digital: Horizontal: 15.62-67.50kHz, Vertical: 24-60Hz
Maximum Resolution		1920 × 1080, 2.1 MegaPixels
Input Connector		VGA(D-sub) mini 15 pin, DVI-D 24 pin, HDMI
Input Audio Connector		ø 3,5mm mini jack (Stereo)
Serial Port		RS-232C
Plug & Play		VESA DDC2B™
Input Sync Signal		Separate sync: TTL, Positive or Negative
Input Video Signal		Analog: 0.7Vp-p (Standard), 75Ω, Positive Digital: DVI (Digital Visual Interface Standard Rev.1.0) compliance Digital: HDMI
Input Audio Signal		1.0Vrms maximum
Speakers		7W×2 (Stereo speakers)
IR Connector		IR Extender
Maximum Screen Size		927.9mm W × 522.0mm H / 36.5" W × 20.6" H
Power Source		100-240VAC, 50/60Hz, 0.8A
Power Consumption* ¹		66W typical, Power management mode: 0.5W maximum Energy Efficiency Class: B
Dimensions / Net Weight		975.5 × 575.0 × 88.0mm / 38.4 × 22.6 × 3.5" (W×H×D) 24.0kg / 59.9lbs
Environmental Considerations		Operating: Temperature 0 to 40°C / 32 to 104°F Humidity 85% (No condensation) Storage: Temperature -20 to 60°C / 4 to 140°F Humidity 85% (No condensation)
Approvals		CE, TÜV-Bauart, CU, IPX1* ²

NOTE *¹ USB peripherals / Audio equipment are not connected.

*² IPX1 Standard Compliant : Only front face

DIMENSIONS : ProLite TF3237MSC

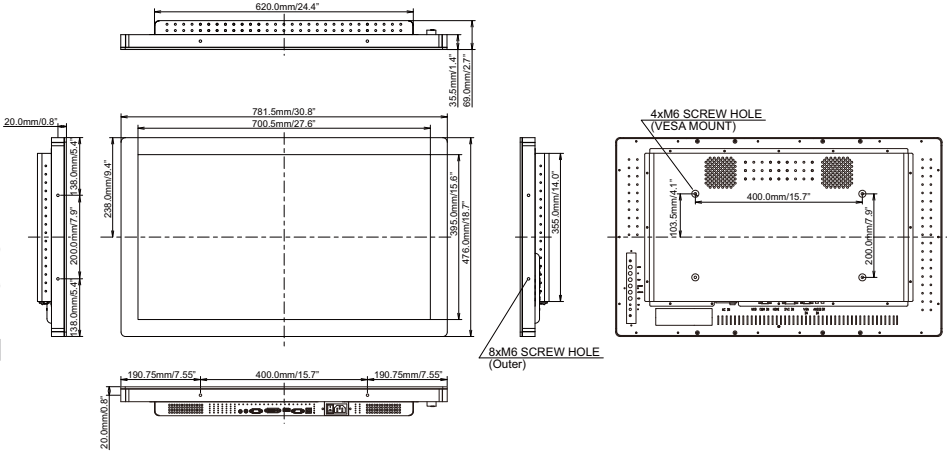

DIMENSIONS : ProLite TF4237MSC

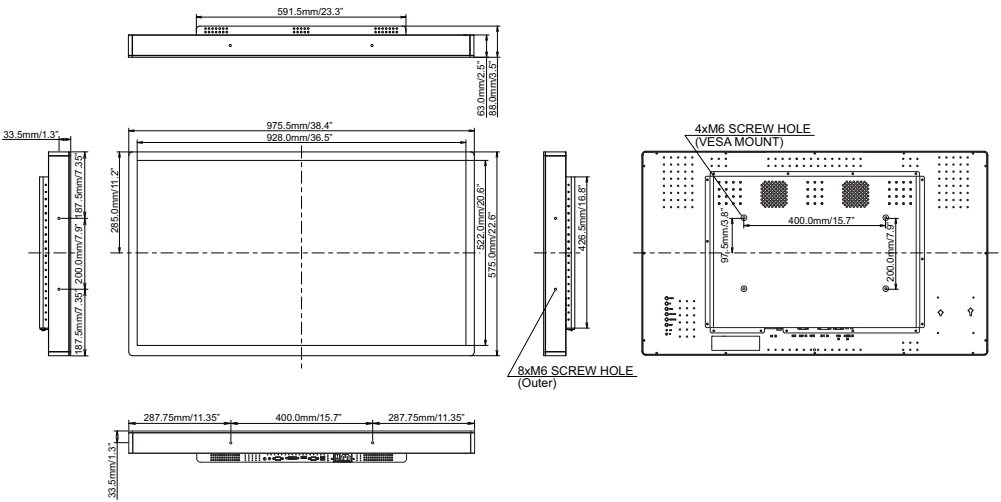

COMPLIANT TIMING

Video Mode		Horizontal Frequency	Vertical Frequency	Dot Clock	
VESA	VGA	640 × 480	31.469kHz	59.940Hz	25.175MHz
		720 × 400	31.467kHz	70.080Hz	28.320MHz
	SVGA	800 × 600	37.879kHz	60.317Hz	40.000MHz
	XGA	1024 × 768	48.363kHz	60.004Hz	65.000MHz
		1280 × 720	44.720kHz	60.000Hz	74.500MHz
		1280 × 768	47.776kHz	59.870Hz	79.500MHz
	SXGA	1280 × 1024	63.981kHz	60.020Hz	108.000MHz
		1366 × 768	47.712kHz	59.790Hz	85.500MHz
WSXGA+	1680 × 1050	65.290kHz	59.954Hz	146.250MHz	
Full HD	1920 × 1080	67.500kHz	60.000Hz	148.500MHz	
SD	480i	60Hz	15.735kHz	59.940Hz	13.500MHz ^{*2}
	576i	50Hz	15.625kHz	50.000Hz	13.500MHz ^{*2}
	480p	60Hz	31.469kHz	59.940Hz	27.000MHz ^{*1}
	576p	50Hz	31.250kHz	50.000Hz	27.000MHz ^{*1}
HD	720p	50Hz	37.500kHz	50.000Hz	74.250MHz ^{*1}
	720p	60Hz	45.000kHz	60.000Hz	74.250MHz ^{*1}
	1080i	50Hz	28.125kHz	50.000Hz	74.250MHz ^{*1}
	1080i	60Hz	33.750kHz	60.000Hz	74.250MHz ^{*1}
	1080p	24Hz	27.000kHz	24.000Hz	74.250MHz ^{*1}
	1080p	30Hz	33.750kHz	30.000Hz	74.250MHz ^{*1}
	1080p	50Hz	56.250kHz	50.000Hz	148.500MHz ^{*1}
	1080p	60Hz	67.500kHz	60.000Hz	148.500MHz ^{*1}

NOTE ^{*1} DVI/HDMI input only.

^{*2} HDMI input only.