

USER MANUAL

ProLite

LCD Monitor

ENGLISH

ProLite T1532MSC
ProLite T1732MSC
ProLite T1932MSC

Thank you very much for choosing the iiyama LCD monitor.
We recommend that you take a few minutes to read this comprehensive manual carefully before installing and switching on the monitor. Please keep this manual in a safe place for your future reference.



Dear user, we congratulate you on the purchase of your iiyama LCD.

For details on warranty and locally used pixel policies that apply directly after installation of your product please check the iiyama website.

To report a fault, please contact your local support centre found at www.iiyama.com/service

Things to check before you call the iiyama information line

- | if the power cable is connected securely and turned on?
- | if the display has been turned on?
- | if the signal cable is connected securely and the correct input selected?
- | if the computer has been restarted with the display connected?
- | if the graphics card is correctly installed with the latest drivers possible?
- | if the correct native resolution has been selected via 'Display Properties'?
- | if the R/G/B signal configuration is correct?
- | if the displays On Screen Menu is shown?
- | if the correct brightness and contrast settings have been set?
- | if given display tolerances and compatibility have been considered?
- | if via the On Screen Menu you have performed a Factory Reset/Recall?

Before reporting the screen defect, please prepare the following information/evidence:

- | model number *
- | purchase receipt and serial number *
- | name and address for collection
- | telephone/fax number, for availability during the day
- | convenient collection date (date, time)
- | short description of the defect

Important Note:

If there is no fault found in the collected equipment after inspection, the transferring party shall incur charges for transport and administration.

If you have checked all of the above and there is still no picture, call our information line for assistance in your country.

* see the identification plate on the back of the case.

CE MARKING DECLARATION OF CONFORMITY

This LCD monitor complies with the requirements of the EC/EU Directive 2004/108/EC "EMC Directive", 2006/95/EC "Low Voltage Directive", 2009/125/EC "ErP Directive" and 2011/65/EU "RoHS Directive".

The electro-magnetic susceptibility has been chosen at a level that gives correct operation in residential areas, business and light industrial premises and small-scale enterprises, inside as well as outside of the buildings. All places of operation are characterised by their connection to the public low voltage power supply system.

IYAMA CORPORATION: Wijkemeerstraat 8, 2131 HA Hoofddorp, The Netherlands



We recommend recycling of used product. Please contact your dealer or iiyama service center. Recycle information is obtained via the Internet, using the address:
<http://www.iiyama.com>

You can access the Web page of different countries from there.

- We reserve the right to change specifications without notice.
- All trademarks used in this user manual are the property of their respective owners.

TABLE OF CONTENTS

FOR YOUR SAFETY.....	1
SAFETY PRECAUTIONS.....	1
SPECIAL NOTES ON LCD MONITORS.....	3
CUSTOMER SERVICE.....	3
CLEANING.....	3
BEFORE YOU OPERATE THE MONITOR.....	4
FEATURES.....	4
CHECKING THE CONTENTS OF THE PACKAGE.....	5
SPECIAL NOTES ON TOUCH PANEL.....	5
WALL MOUNTING.....	5
BUILT-IN EQUIPMENT.....	5
CONTROLS AND CONNECTORS.....	6
CONNECTING YOUR MONITOR.....	7
COMPUTER SETTING.....	8
ADJUSTING THE VIEWING ANGLE.....	9
OPERATING THE MONITOR.....	10
ADJUSTMENT MENU CONTENTS.....	11
SCREEN ADJUSTMENTS.....	16
POWER MANAGEMENT FEATURE.....	19
TROUBLE SHOOTING.....	20
RECYCLING INFORMATION.....	21
APPENDIX.....	22
SPECIFICATIONS : ProLite T1532MSC.....	22
SPECIFICATIONS : ProLite T1732MSC.....	23
SPECIFICATIONS : ProLite T1932MSC.....	24
DIMENSIONS : ProLite T1532MSC.....	26
DIMENSIONS : ProLite T1732MSC.....	26
DIMENSIONS : ProLite T1932MSC.....	26
COMPLIANT TIMING.....	27

FOR YOUR SAFETY

SAFETY PRECAUTIONS

WARNING

STOP OPERATING THE MONITOR WHEN YOU SENSE TROUBLE

If you notice any abnormal phenomena such as smoke, strange sounds or fumes, unplug the monitor and contact your dealer or iiyama service center immediately. Further use may be dangerous and can cause fire or electric shock.

NEVER REMOVE THE CABINET

High voltage circuits are inside the monitor. Removing the cabinet may expose you to the danger of fire or electric shock.

DO NOT PUT ANY OBJECT INTO THE MONITOR

Do not put any solid objects or liquids such as water into the monitor. In case of an accident, unplug your monitor immediately and contact your dealer or iiyama service center. Using the monitor with any object inside may cause fire, electric shock or damage.

INSTALL THE MONITOR ON A FLAT, STABLE SURFACE

The monitor may cause an injury if it falls or is dropped.

DO NOT USE THE MONITOR NEAR WATER

Do not use where water may be splashed or spilt onto the monitor as it may cause fire or electric shock.

OPERATE UNDER THE SPECIFIED POWER SUPPLY

Be sure to operate the monitor only with the specified power supply. Use of an incorrect voltage will cause malfunction and may cause fire or electric shock.

PROTECT THE CABLES

Do not pull or bend the power cable and signal cable. Do not place the monitor or any other heavy objects on the cables. If damaged, the cables may cause fire or electric shock.

ADVERSE WEATHER CONDITIONS

It is advisable not to operate the monitor during a heavy thunder storm as the continual breaks in power may cause malfunction. It is also advised not to touch the plug in these circumstances as it may cause electric shock.

CAUTION

INSTALLATION LOCATION

Do not install the monitor where sudden temperature changes may occur, or in humid, dusty or smoky areas as it may cause fire, electric shock or damage. You should also avoid areas where the sun shines directly on the monitor.

DO NOT PLACE THE MONITOR IN A HAZARDOUS POSITION

The monitor may topple and cause injury if not suitably located. Please also ensure that you do not place any heavy objects on the monitor, and that all cables are routed such that children may not pull the cables and possibly cause injury.

MAINTAIN GOOD VENTILATION

Ventilation slots are provided to keep the monitor from overheating. Covering the slots may cause fire. To allow adequate air circulation, place the monitor at least 10 cm (or 4 inches) from any walls. Do not remove the tilt stand when operating the monitor. Ventilation slots on the back of the cabinet will be blocked and the monitor may overheat if the stand is removed. This may cause fire or damage. Operating the monitor on its back, side, upside down or on a carpet or any other soft material may also cause damage.

DISCONNECT THE CABLES WHEN YOU MOVE THE MONITOR

When you move the monitor, turn off the power switch, unplug the monitor and be sure the signal cable is disconnected. If you do not disconnect them, it may cause fire or electric shock.

UNPLUG THE MONITOR

If the monitor is not in use for a long period of time it is recommended that it is left unplugged to avoid accidents.

HOLD THE PLUG WHEN DISCONNECTING

To disconnect the power cable or signal cable, always pull it by the plug. Never pull on the cable itself as this may cause fire or electric shock.

DO NOT TOUCH THE PLUG WITH WET HANDS

Pulling or inserting the plug with wet hands may cause electric shock.

WHEN YOU INSTALL THE MONITOR ON YOUR COMPUTER

Be sure the computer is strong enough to hold the weight of the monitor, otherwise, you may damage your computer.

REMARK FOR 24/7 USAGE

This product is not specifically designed for 24/7 usage in all environments.

OTHERS

ERGONOMIC RECOMMENDATIONS

To eliminate eye fatigue, do not operate the monitor against a bright background or in a dark room. For optimal viewing comfort, the monitor should be just below eye level and 40-60 cm (16-24 inches) away from your eyes. When using the monitor over a prolonged time, a ten minute break every hour is recommended as looking at the screen continuously can cause eye strain.

SPECIAL NOTES ON LCD MONITORS

The following symptoms are normal with LCD monitors and do not indicate a problem.

NOTE

- When you first turn on the LCD monitor, the picture may not fit in the display area because of the type of computer that is used. In this case, adjust the picture position to the correct position.
- You may find slightly uneven brightness on the screen depending on the desktop pattern you use.
- Due to the nature of the LCD screen, an afterimage of the previous screen may remain after switching the image, when the same image is displayed for hours. In this case, the screen is recovered slowly by changing the image or turning off the Power Switch for hours.
- Contact your dealer or iiyama service center for the backlight replacement when the screen is dark, flickering or not lighting up. Never attempt to replace it by yourself.

CUSTOMER SERVICE

NOTE

- The fluorescent light used in the LCD monitor may have to be periodically replaced. For the warranty coverage on this component, please check with local iiyama service center.
- If you have to return your unit for service and the original packaging has been discarded, please contact your dealer or iiyama service center for advice or replacement packaging.

CLEANING

WARNING

- If you drop any materials or liquids such as water into the monitor when cleaning, unplug the power cable immediately and contact your dealer or iiyama service center.

NOTE

- To protect the Touch screen surface, do not scratch or rub the screen with a hard object.
- Never use any of the following strong solvents. These will damage the cabinet and the Touch screen surface.
Abrasive cleaner Wax Solvent
- Touching the cabinet with any product made from rubber or plastic for a long time may cause degeneration or loss of paint on the cabinet.

CABINET

Stains can be removed with a cloth lightly moistened with a mild detergent solvent. Then wipe the cabinet with a soft dry cloth.

TOUCH SCREEN

Touch screen surface may be cleaned using a soft clean cloth moistened with mild window glass commercial cleaners or 50/50 mixture of water and isopropyl alcohol.

BEFORE YOU OPERATE THE MONITOR

FEATURES

- ◆ Supports Resolutions up to 1024 × 768 : ProLite T1532MSC
- ◆ Supports Resolutions up to 1280 × 1024 : ProLite T1732MSC / ProLite T1932MSC
- ◆ High Contrast 500:1 (Typical: with Touch panel) / Brightness 225cd/m² (Typical: with Touch panel) : ProLite T1532MSC
- ◆ High Contrast 1000:1 (Typical: with Touch panel) / Brightness 225cd/m² (Typical: with Touch panel) : ProLite T1732MSC
- ◆ High Contrast 800:1 (Typical: with Touch panel) / Brightness 225cd/m² (Typical: with Touch panel) : ProLite T1932MSC-B1 / ProLite T1932MSC-B1X
- ◆ High Contrast 1000:1 (Typical: with Touch panel) / Brightness 225cd/m² (Typical: with Touch panel) : ProLite T1932MSC-B2X
- ◆ Digital Character Smoothing
- ◆ Automatic Set-up
- ◆ Stereo Speakers
2 × 1W Stereo Speakers
- ◆ Plug & Play VESA DDC2B Compliant
Windows[®] 95/98/2000/Me/XP/Vista/7 Compliant
- ◆ Power Management (VESA DPMS Compliant)
- ◆ VESA Mounting Standard (100mm×100mm) Compliant
- ◆ Keyhole for Security Lock
- ◆ IP54 Standard Compliant (Only front face)

■ Windows8/8.1 touch environment

Basic touch operations can be performed under Windows 8/8.1.

However, please be informed that full touch functionality and normal operational performance are not guaranteed.

CHECKING THE CONTENTS OF THE PACKAGE

The following accessories are included in your package. Check to see if they are enclosed with the monitor. If anything is missing or damaged, please contact your local iiyama dealer or regional iiyama office.

- Power Cable*¹
- USB Cable
- Touch Panel Driver Disk (CD-ROM)*²
- Quick Start Guide
- VGA(D-sub) Signal Cable
- Audio Cable
- DVI-D Cable
- Screw (M3x6mm)
- Safety Guide

CAUTION *¹ The rating of the Power Cable enclosed in 120V area is 10A/125V. If you are using a power supply higher than this rating, then a power cable with a rating of 10A/250V must be used. However, all guarantees and warranties are void for any problems or damage caused by a power cable not supplied by iiyama.

*² This CD-ROM contains the touch screen driver software.
Install the Touch Panel Driver Disk after connecting the computer to the monitor with USB Cable. For the details, see Readme file in the Touch Panel Driver Disk.

SPECIAL NOTES ON TOUCH PANEL

Permanent damage can occur if Sharp Edged, Pointed or Metal items are used to activate Touch. This could invalidate any remaining warranty.

We recommend to use a plastic stylus (tip R0.8 or over) or finger.

WALL MOUNTING

WARNING When you use with the wall mounting, in consideration of thickness of the mounting stage, tighten the M4 Screw with washer which "L" length is 8mm to fasten the monitor. Using the screw longer than this may cause electric shock or damage because it may contact with the electrical parts inside the monitor.

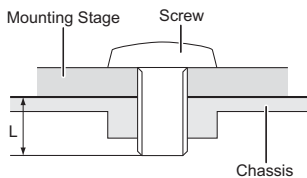

BUILT-IN EQUIPMENT

WARNING This product is not designed for the purpose of being used in high temperature environment.
If the product is placed in an external cabinet, you need to design cooling fans and vents to keep the temperature low enough to fit in the product temperature specification.



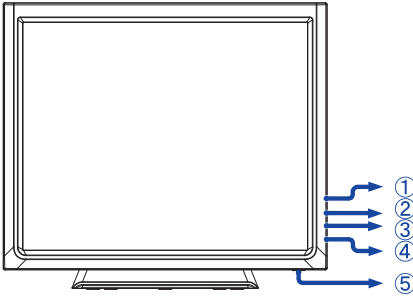

CONTROLS AND CONNECTORS

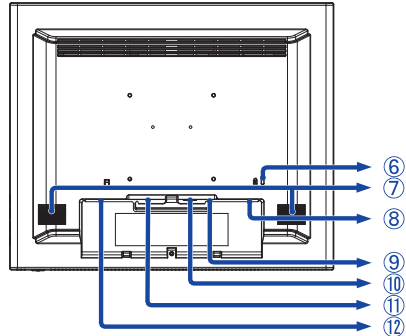

<Front>



<Back>

- ① Menu Button ()
- ② Scroll Up / Brightness Button ()
- ③ Scroll Down / Mute Button ()
- ④ Select / Auto Button ()
- ⑤ Power Switch ()
- ⑥ Keyhole for Security Lock
- ⑦ Speakers
- ⑧ USB Connector
- ⑨ Audio Connector
- ⑩ VGA(D-sub) mini 15pin Connector
- ⑪ DVI-D 24pin Connector
- ⑫ AC Connector

NOTE You can fasten a security lock and cable to prevent the monitor from being removed without your permission.

[Fitting and Removal of Cable Cover]

• Removal

- ① Press and hold  of the Cable Cover and remove the Cable Cover.

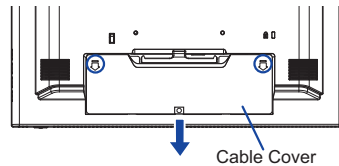

Cable Cover

• Fitting

- ① Place the Cable Cover.
- ② Fix the Monitor with the Cable Cover by the screw firmly.

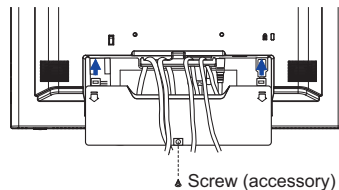

▲ Screw (accessory)

CONNECTING YOUR MONITOR

- ① Ensure that both the computer and the monitor are switched off.
- ② Connect the computer to the monitor with the signal cable.
- ③ Connect the computer to the monitor with the USB Cable.
- ④ Connect the monitor to the audio equipment with the Audio Cable for computer when using the audio features.
- ⑤ Connect the Power Cable to the monitor first and then to the power supply.
- ⑥ Turn on your monitor and computer.

- NOTE**
- The signal cables used for connecting the computer and monitor may vary with the type of computer used. An incorrect connection may cause serious damage to both the monitor and the computer. The cable supplied with the monitor is for a standard connector. If a special cable is required please contact your local iiyama dealer or regional iiyama office.
 - For connection to Macintosh computers, contact your local iiyama dealer or regional iiyama office for a suitable adaptor.
 - Make sure you tighten the finger screws at each end of the Signal Cable.
 - Don't connect the USB cable to the computer at the same time. And cannot use those at the same time.

[Example of Connection]

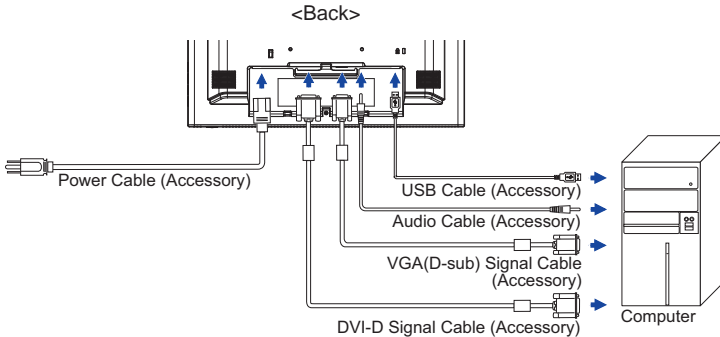

[Collect Cables]

- ① Put the cables through the cable holder and holes.
- ② Collect cables at the back of the stand.

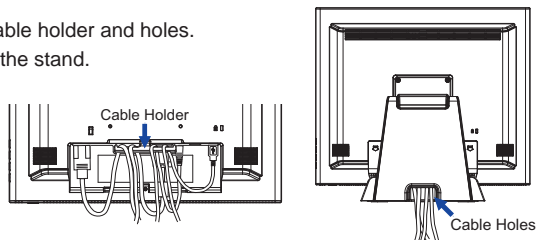

COMPUTER SETTING

■ Signal Timing

Change to the desired signal timing listed on page 27: COMPLIANT TIMING.

■ Windows 95/98/2000/Me/XP/Vista/7 Plug & Play

The iiyama LCD monitor complies with DDC2B of VESA standard. The Plug & Play function runs on Windows 95/98/2000/Me/XP/Vista/7 by connecting the monitor to DDC2B compliant computer with the Signal Cable supplied.

For installation on Windows 95/98/2000/Me/XP: The monitor Information File for iiyama monitors may be necessary for your computer and obtained via the Internet, using the address:

<http://www.iiyama.com>

NOTE

■ For additional information on how to download the driver for your touch screen monitor, please access the internet site noted above.

■ Monitor Drivers are not required in most cases for Macintosh or Unix operating systems. For further information, please contact your computer dealer first for advice.

■ Procedure for turning ON the Power Switch

Turn ON the monitor first, and then the computer.

■ Touch screen driver software

Touch screen driver software and system may not start when you start your computer while touching the screen.

Touch screen driver software may not run due to the power saving function depending on the BIOS of your computer. In this case, set the power saving function to off.

■ TOUCH support operation system

Microsoft Windows XP (64 bit and 32 bit)

Microsoft Windows Vista (64 bit and 32 bit)

Microsoft Windows 7 (64 bit and 32 bit)

Microsoft Windows 8 / 8.1 (64 bit and 32 bit)

Microsoft Windows CE 2.13 / 3.0, net 6.0

Mac OS9.x, OS X V10.4/10.5/10.6 & above

Linux (Kernel2.4, 2.6x) & above

Not support earlier versions.

	Windows8/8.1	Windows7*5	Windows7*4	Vista	XP
Default mouse*1	○	○	○	○	○
Touch digitizer*2	○	○	○	○	×
Windows7 gestures*3	○	○	×	×	×

	2K	Windows CE	XP Embedded	Mac OS9,OSX	Linux
Default mouse*1	○	○	○	○	○
Touch digitizer*2	×	×	×	×	×
Windows7 gestures*3	×	×	×	×	×

*1 Default mouse (click, drag, double-click and right-click)

*2 Touch digitizer (click, drag /selection, double-click, right-click, flick and visual feedback)

*3 Digitizer with Windows7 touch gestures

*4 Windows 7 - Starter and Home Basic version

*5 Windows 7 - Home Premium, Professional, Enterprise and Ultimate versions

ADJUSTING THE VIEWING ANGLE

- For optimal viewing it is recommended to look at the full face of the monitor.
- Hold the panel so that the monitor does not topple when you change the monitor's angle.
- You are able to adjust the monitor's angle up to 90 degrees upward, 5 degrees downward.

- NOTE**
- Do not touch the LCD screen when you change the angle. It may cause damage or break the LCD screen.
 - Careful attention is required not to catch your fingers or hands when you change the angle.

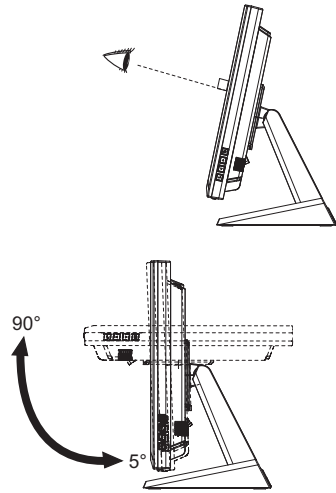



OPERATING THE MONITOR

To create the best picture, your iiyama LCD monitor has been preset at the factory with the COMPLIANT TIMING shown on page 27. You are also able to adjust the picture by following the button operation shown below. For more detailed adjustments, see page 16 for SCREEN ADJUSTMENTS.

- ① Press the  Button to start the On Screen Display feature. There are additional Menu items which can be switched by using the Δ / ∇ Buttons.



- ② Select the Menu item which contains the adjustment icon relating to the adjustment you want to make. Use the \leftarrow / \rightarrow Buttons to highlight the desired adjustment icon.
- ③ Use the Δ / ∇ Buttons to make the appropriate adjustment or setting.
- ④ Press the  Button to leave the menu, and the settings you just made would be automatically saved.

For example, to correct for vertical position, select Menu item of . Then, select V-POSITION by using the \leftarrow / \rightarrow Buttons.

Use the Δ / ∇ Buttons to change the vertical position settings. The vertical position of the overall display should be changing accordingly while you are doing this.

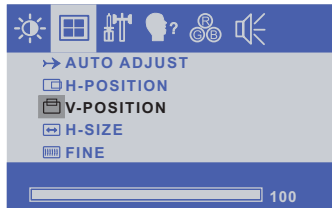

Press the  Button lastly, it ends, any changes are saved in the memory.

NOTE

- When button operations are aborted during adjustment, On-Screen Display disappears when the time set for the OSD TIMEOUT has passed.
- \leftarrow button can be used to return previous menu item.
- Any changes are automatically saved in the memory when the On Screen Display disappears. Turning off the power should be avoided while using the Menu.
- Adjustments for H/V-POSITION, H-SIZE and FINE are saved for each signal timing. Except for these adjustments, all other adjustments have only one setting which applies to all signal timings.

ADJUSTMENT MENU CONTENTS

Adjustment Item	Problem / Option	Button to Press
CONTRAST	Too dull Too intense	△ ▽
BRIGHTNESS * Direct	Too dark Too bright	△ ▽

* Adjust the Brightness when you are using the monitor in a dark room and feel the screen is too bright.

Direct

You can skip the Menu items and display an adjustment scale directly by using the following button operations.

- BRIGHTNESS: Press the △ Button when the Menu is not displayed.

Direct

- LOCK MODE:

Press the button to display the OSD menu, and press the button again to turn off the OSD menu. And then press the POWER SWITCH and button at the same time.

* The OSD menu is not displayed when the OSD is locked. Pressing and holding the button again and press the Power Switch.





















The following OSD menu is displayed.

Adjustment Item	Problem / Option	
POWER	LOCK	The POWER SWITCH is Locked.
	UNLOCK	The POWER SWITCH is Unlocked.
OSD	LOCK	The OSD menu is Locked.
	UNLOCK	The OSD menu is Unlocked.

- TOUCH FANCTION DISABLE:

ON: Pressing and holding of the Button and the Button at the same time when the Menu is not displayed, message "TOUCH DISABLE" will appear on the top right corner.

OFF: Pressing and holding of the Button and the Button at the same time for about 5 seconds when the Menu is not displayed, till "TOUCH DISABLE" disappears.

 <div style="border: 1px solid black; padding: 2px; display: inline-block;">Only Analog Input</div> <div style="float: right; background-color: #4a7ebb; color: white; padding: 5px; text-align: center;">       </div> <div style="clear: both;"></div> <div style="background-color: #4a7ebb; color: white; padding: 2px; text-align: center;"> → AUTO ADJUST H-POSITION V-POSITION H-SIZE FINE </div>	
Adjustment Item	Problem / Option Button to Press
AUTO ADJUST * ¹ Direct	Adjust H/V-POSITION, H-SIZE and FINE automatically.
H-POSITION	<div style="display: flex; justify-content: space-between;"> <div style="text-align: center;">  Too left  Too right </div> <div style="text-align: center;">  △  ▽ </div> </div>
V-POSITION	<div style="display: flex; justify-content: space-between;"> <div style="text-align: center;">  Too low  Too high </div> <div style="text-align: center;">  △  ▽ </div> </div>
H-SIZE * ²	<div style="display: flex; justify-content: space-between;"> <div style="text-align: center;">  Too narrow  Too wide </div> <div style="text-align: center;">  △  ▽ </div> </div>
FINE * ²	To correct flickering text or lines <div style="text-align: center; margin-top: 10px;">  △  ▽ </div>

*¹ For best results, use the Auto Adjust in conjunction with the adjustment pattern. See page 16 for SCREEN ADJUSTMENTS.

*² See page 16 for SCREEN ADJUSTMENTS.

Direct

You can skip the Menu items and display an adjustment scale directly by using the following button operations.

- AUTO ADJUST: Press the  Button when the Menu is not displayed.

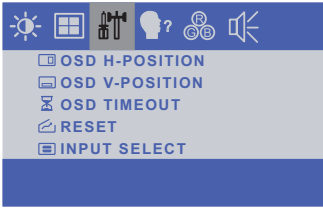

Adjustment Item	Problem / Option		Button to Press
OSD H-POSITION	OSD is too left OSD is too right		
OSD V-POSITION	OSD is too low OSD is too high		
OSD TIMEOUT	You can set the OSD display duration time between 5 and 60 seconds.		
RESET	Factory-preset data is restored.		
INPUT SELECT Direct	AUTO	Search for an available input source and select automatically. Available for ProLite T1532MSC-B1X, ProLite T1732MSC-B1X, ProLite T1932MSC-B1X and ProLite T1932MSC-B2X only.	
	VGA	Select the analog input.	
	DVI	Select the digital input.	
NOTE However it will automatically be selected when just one source is using. In Power Management Mode input switching is disabled. Input source is fixed, not selected automatically when VGA and DVI which are selected.			





Direct Available for ProLite T1532MSC-B1X, ProLite T1732MSC-B1X, ProLite T1932MSC-B1X and ProLite T1932MSC-B2X only.

You can skip the Menu items and display an adjustment scale directly by using the following button operations.

- **INPUT SELECT:** Pressing and holding of the Button for about 3 seconds when the Menu is not displayed. When both VGA and DVI signal inputs are connected to a signal source, you can switch between them by successively pressing the Button.



Adjustment Item	Problem / Option Button to Press
OSD LANGUAGE	ENGLISH English ESPAÑOL Spanish
	FRANÇAIS French 日本語 Japanese
	DEUTSCH German 繁体字 Traditional Chinese
	ITALIANO Italian 简体字 Simplified Chinese

Adjustment Item	Problem / Option Button to Press				
COLOR TEMP.	9300 Bluish white				
	6500 Reddish white				
	5500 Greenish white				
	7500 Yellowish white				
	USER <table border="1" style="display: inline-table; vertical-align: middle;"> <tr> <td>RED</td> <td rowspan="3"> Too weak Too strong </td> <td rowspan="3"> </td> </tr> <tr> <td>GREEN</td> </tr> <tr> <td>BLUE</td> </tr> </table>	RED	Too weak Too strong		GREEN
RED	Too weak Too strong				
GREEN					
BLUE					

Adjustment Item		Problem / Option		Button to Press
VOLUME		Too soft		 
		Too loud		 
MUTE	Direct	ON	Turn off the sound temporarily.	
		OFF	Return the sound volume to the previous level.	

Direct

You can skip the Menu items and display an adjustment scale directly by using the following button operations.

- MUTE : Press the  Button when the Menu is not displayed.
 -  : MUTE ON
 -  : MUTE OFF

SCREEN ADJUSTMENTS

Adjust the image by following the procedure below to get the desired picture when selecting Analog input.

- The screen adjustments described in this manual are designed to set image position and minimize flicker or blur for the particular computer in use.
- ProLite T1532MSC is designed to provide the best performance at resolution of 1024 × 768, but can not provide the best at resolutions of less than 1024 × 768 because the picture is automatically stretched to fit the full screen. It is recommended to operate at resolution of 1024 × 768 in normal use.
- ProLite T1732MSC and ProLite T1932MSC are designed to provide the best performance at resolution of 1280 × 1024, but can not provide the best at resolutions of less than 1280 × 1024 because the picture is automatically stretched to fit the full screen. It is recommended to operate at resolution of 1280 × 1024 in normal use.
- Displayed text or lines will be blurred or irregular in thickness when the picture is stretched due to the screen enlargement process.
- It is preferable to adjust the image position and frequency with the monitor controls, rather than the computer software or utilities.
- Perform adjustments after a warm-up period of at least thirty minutes.
- Additional adjustments may be required after the Auto Adjust depending on the resolution or signal timing.
- The Auto Adjust may not work correctly when displaying the picture other than the screen adjustment pattern. In this case, manual adjustments are required.

There are two ways to adjust the screen. One way is automatic adjustment for H/V-POSITION, H-SIZE and FINE. The other way is performing each adjustment manually.

Perform the Auto Adjust first when the monitor is connected to a new computer, or resolution is changed. If the screen has a flicker or blur, or the picture does not fit in the display area after performing the Auto Adjust, manual adjustments are required. Both adjustments should be made by using the screen adjustment pattern (Test.bmp) obtained via the Iiyama web site (<http://www.iiyama.com>).

Adjust the image by following the procedure below to get the desired picture.
This manual explains adjustment under Windows 95/98/2000/Me/XP/Vista/7.

- ① **Display the picture at the optimum resolution.**
- ② **Enter the Test.bmp (screen adjustment pattern) to wallpaper.**

NOTE

- Consult the appropriate documentation for doing this.
- Test.bmp is made at resolution of 1280 × 1024. Set the display position to center in the wallpaper setting dialogue box. If you use Microsoft® PLUS! 95/98 cancel the setting of "Stretch desktop wallpaper to fit the screen".

[Adjustment pattern]

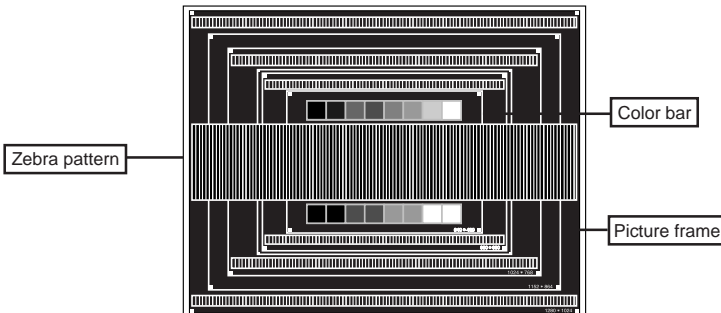

- ③ Press the AUTO Button. (AUTO ADJUST)
- ④ Adjust the image manually by following procedure below when the screen has a flicker or blur, or the picture does not fit in the display area after performing the Auto Adjust.
- ⑤ Adjust the V-POSITION so that the top and bottom of the picture frame will fit to the display area.

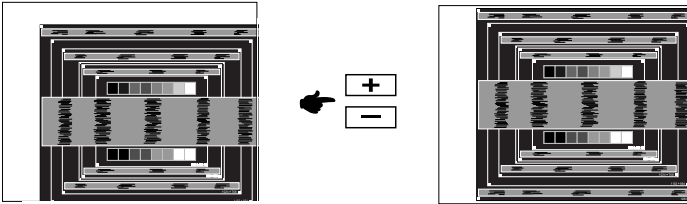

- ⑥ 1) Adjust the H-POSITION so that the left side of the picture frame will move to the left edge of the display area.

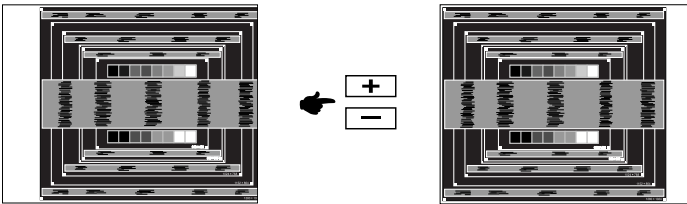

- 2) Stretch the right side of the picture frame to the right edge of the display area by adjusting the H-SIZE.

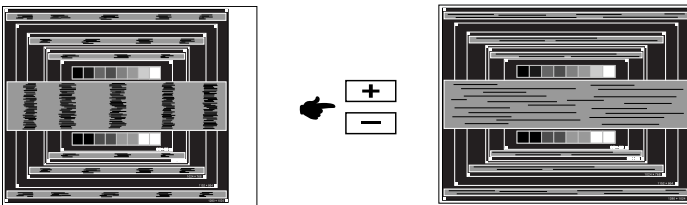
**NOTE**

- When the left side of the picture frame moves apart from the left edge of the display area during the H-SIZE adjustment, adjust steps 1) and 2).
- Another way to make the H-SIZE adjustment is to correct the vertical wavy lines in the zebra pattern.
- The picture may flicker during the H-SIZE, H/V-POSITION adjustment.
- In case the picture frame is bigger or smaller than the data display area after the H-SIZE adjustment, repeat steps from ③.

- ⑦ Adjust the FINE to correct horizontal wavy noise, flicker or blur in the zebra pattern.

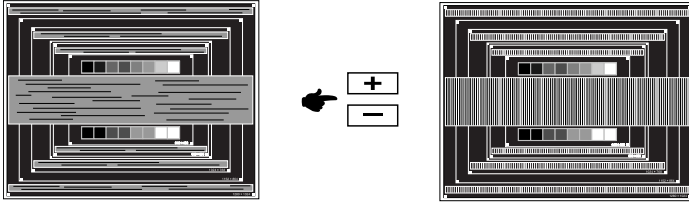
**NOTE**

- In case the strong flicker or blurs remain on a part of the screen, repeat steps ⑥ and ⑦ because the H-SIZE may not be adjusted correctly. If the flicker or blurs still remain, set the refresh rate of computer to low (60Hz) and repeat steps from ③ again.
 - Adjust the H-POSITION after the FINE adjustment if the horizontal position moves during the adjustment.
- ⑧ Adjust the Brightness and Color to get the desired picture after you complete the H-SIZE and FINE adjustments.
Put back your favorite wallpaper.

POWER MANAGEMENT FEATURE

The power management feature of this product complies with power saving requirement of VESA DPMS. When activated, it automatically reduces unnecessary power consumption of the monitor when your computer is not in use.

To use the feature, the monitor needs to be connected to a VESA DPMS compliant computer. There is a power management step the monitor takes as described below. The power management function, including any timer settings is configured by the operating system. Check your operating system manual for information on how this can be configured.

■ Power Management Mode

When the H-sync signal / V-sync signal / H and V sync signals from the computer are off, the monitor enters into Power Management Mode which reduces the power consumption to less than 2W. The screen becomes dark. From Power Management Mode, the image reappears in several seconds when either the keyboard or the mouse are touched again.

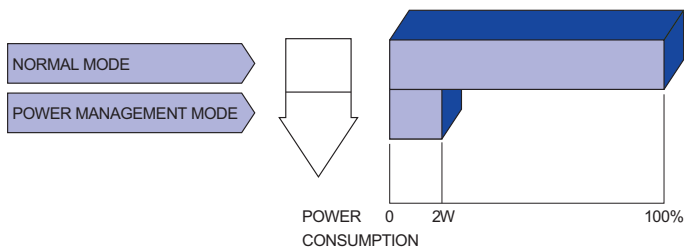

NOTE

- Even when using the power management mode, the monitor consumes electricity. Turn off the Power Switch whenever the monitor is not in use, during the night and weekends, to avoid unnecessary power consumption.
- It is possible that the video signal from the computer may be on while the H or V sync signal is missing. In this instance, the POWER MANAGEMENT feature may not work properly.

TROUBLE SHOOTING

If the monitor fails to operate correctly, please follow the steps below for a possible solution.

1. Perform the adjustments described in OPERATING THE MONITOR, depending on the problem you have. If the monitor does not get a picture, skip to 2.
2. Consult the following items if you cannot find an appropriate adjustment item in OPERATING THE MONITOR or if the problem persists.
3. If you are experiencing a problem which is not described below or you cannot correct the problem, discontinue using the monitor and contact your dealer or iiyama service center for further assistance.

Problem	Check
① The picture does not appear.	<input type="checkbox"/> The Power Cable is firmly seated in the socket. <input type="checkbox"/> The Power Switch is turned ON. <input type="checkbox"/> The AC socket is live. Please check with another piece of equipment. <input type="checkbox"/> If the blank screen saver is in active mode, touch the keyboard or the mouse. <input type="checkbox"/> Increase the Contrast and/or Brightness. <input type="checkbox"/> The computer is ON. <input type="checkbox"/> The Signal Cable is properly connected. <input type="checkbox"/> The signal timing of the computer is within the specification of the monitor. <input type="checkbox"/> If the monitor is in power management mode, touch the keyboard or the mouse.
② The screen is not synchronized.	<input type="checkbox"/> The Signal Cable is properly connected. <input type="checkbox"/> The signal timing of the computer is within the specification of the monitor. <input type="checkbox"/> The video output level of the computer is within the specification of the monitor.
③ The screen position is not in the center.	<input type="checkbox"/> The signal timing of the computer is within the specification of the monitor.
④ The screen is too bright or too dark.	<input type="checkbox"/> The video output level of the computer is within the specification of the monitor.
⑤ The screen is shaking.	<input type="checkbox"/> The power voltage is within the specification of the monitor. <input type="checkbox"/> The signal timing of the computer is within the specification of the monitor.
⑥ No sound.	<input type="checkbox"/> The audio equipment (computer etc.) is ON. <input type="checkbox"/> The Audio Cable is properly connected. <input type="checkbox"/> The Volume is turned up. <input type="checkbox"/> The Mute is OFF. <input type="checkbox"/> The audio output level of the audio equipment is within the specification of the monitor.
⑦ The sound is too loud or too quiet.	<input type="checkbox"/> The audio output level of the audio equipment is within the specification of the monitor.
⑧ A strange noise is heard.	<input type="checkbox"/> The Audio Cable is properly connected.
⑨ The touch screen shows no response.	<input type="checkbox"/> The USB Cable is firmly seated in the socket. <input type="checkbox"/> Touch screen driver software is installed.
⑩ The touch position does not deviate.	<input type="checkbox"/> The calibration function set up correctly.

RECYCLING INFORMATION

For better environment protection please don't dispose your monitor.
Please visit our web site: www.iiyama.com/recycle for monitor recycling.

APPENDIX

Design and specifications are subject to change without prior notice.

SPECIFICATIONS : ProLite T1532MSC

Model Name		ProLite T1532MSC-B1	ProLite T1532MSC-B1X
Touch Screen	Technology	Projected capacitive 2pt touch	Projected capacitive 10pt touch
	Light transmission	90%	
	Communication system	USB serial transfer	
Size Category		15"	
LCD Panel	Driving system	a-Si TFT Active Matrix	
	Size	Diagonal: 15" (38cm)	
	Pixel pitch	0.297mm H x 0.297mm V	
	Brightness	225cd/m ² (Typical: with Touch panel)	
	Contrast ratio	500 : 1 (Typical: with Touch panel)	
	Viewable angle	Horizontal : 140 degrees, Vertical: 125 degrees (Typical)	
	Response time	8ms (Black, White, Black Typical)	
Display Colors		Approx. 16.7M	
Sync Frequency		Horizontal: 31.4-60.0kHz, Vertical: 56-75Hz	
Maximum Resolution		1024 x 768, 0.8 MegaPixels	
Input Connector		VGA(D-sub) mini 15 pin, DVI-D 24 pin	
Plug & Play		VESA DDC2B™	
Input Sync Signal		Separate sync: TTL, Positive or Negative	
Input Video Signal		Analog: 0.7Vp-p (Standard), 75Ω, Positive Digital: DVI (Digital Visual Interface Standard Rev.1.0) compliance	
Input Audio Connector		ø 3.5mm mini jack (Stereo)	
Input Audio Signal		1.0Vrms maximum	
Speakers		1W x 2 (Stereo speakers)	
Maximum Screen Size		304.0mm W x 228.0mm H / 12.0" W x 9.0" H	
Power Source		100-240VAC, 50/60Hz, 1A	
Power Consumption*1		20W typical, Power management mode: 2W maximum	
Dimensions / Net Weight		351.0 x 306.5 x 202.0mm / 13.8 x 12.1 x 7.9" (WxHxD) 4.5kg / 9.9lbs	
Tilt Angle		Upward: 90 degrees Downward: 5 degrees	
Environmental Considerations		Operating: Temperature 0 to 40°C / 32 to 104°F Humidity 20 to 80% (No condensation) Storage: Temperature -20 to 60°C / -4 to 140°F Humidity 10 to 90% (No condensation)	
Approvals		CB, CE, TÜV-Bauart, CU, cULus, VCCI, IP54*2	

NOTE *1 USB peripherals / Audio equipment are not connected.

*2 IP54 Standard Compliant : Only front face

SPECIFICATIONS : ProLite T1732MSC

Model Name		ProLite T1732MSC-B1	ProLite T1732MSC-B1X
Touch Screen	Technology	Projected capacitive 2pt touch	Projected capacitive 10pt touch
	Light transmission	90%	
	Communication system	USB serial transfer	
Size Category		17"	
LCD Panel	Driving system	a-Si TFT Active Matrix	
	Size	Diagonal: 17" (43cm)	
	Pixel pitch	0.264mm H x 0.264mm V	
	Brightness	225cd/m ² (Typical: with Touch panel)	
	Contrast ratio	1000 : 1 (Typical: with Touch panel)	
	Viewable angle	Horizontal : 160 degrees, Vertical: 160 degrees (Typical)	Horizontal : 170 degrees, Vertical: 160 degrees (Typical)
	Response time	5ms (Black, White, Black Typical)	
Display Colors		Approx.16.7M	
Sync Frequency		Horizontal: 31.4-80.0kHz, Vertical: 56-75Hz	
Maximum Resolution		1280 x 1024, 1.3 MegaPixels	
Input Connector		VGA(D-sub) mini 15 pin, DVI-D 24 pin	
Plug & Play		VESA DDC2B™	
Input Sync Signal		Separate sync: TTL, Positive or Negative	
Input Video Signal		Analog: 0.7Vp-p (Standard), 75Ω, Positive Digital: DVI (Digital Visual Interface Standard Rev.1.0) compliance	
Input Audio Connector		ø 3.5mm mini jack (Stereo)	
Input Audio Signal		1.0Vrms maximum	
Speakers		1W x 2 (Stereo speakers)	
Maximum Screen Size		338.0mm W x 270.5mm H / 13.3" W x 10.6" H	
Power Source		100-240VAC, 50/60Hz, 1A	
Power Consumption* ¹		20W typical, Power management mode: 2W maximum	
Dimensions / Net Weight		387.0 x 342.0 x 202.0mm / 15.2 x 13.5 x 7.9" (WxHxD) 5.6kg / 12.3lbs	
Tilt Angle		Upward: 90 degrees Downward: 5 degrees	
Environmental Considerations		Operating: Temperature 0 to 40°C / 32 to 104°F Humidity 20 to 80% (No condensation) Storage: Temperature -20 to 60°C / -4 to 140°F Humidity 10 to 90% (No condensation)	
Approvals		CB, CE, TÜV-Bauart, CU, cULus, VCCI, IP54* ²	

NOTE *¹ USB peripherals / Audio equipment are not connected.

*² IP54 Standard Compliant : Only front face

SPECIFICATIONS : ProLite T1932MSC

Model Name		ProLite T1932MSC-B1	ProLite T1932MSC-B1X
Touch Screen	Technology	Projected capacitive 2pt touch	Projected capacitive 10pt touch
	Light transmission	90%	
	Communication system	USB serial transfer	
Size Category		19"	
LCD Panel	Driving system	a-Si TFT Active Matrix	
	Size	Diagonal: 19" (48cm)	
	Pixel pitch	0.294mm H x 0.294mm V	
	Brightness	225cd/m ² (Typical: with Touch panel)	
	Contrast ratio	800 : 1 (Typical: with Touch panel)	
	Viewable angle	Horizontal : 170 degrees, Vertical: 160 degrees (Typical)	
	Response time	5ms (Black, White, Black Typical)	
Display Colors		Approx.16.7M	
Sync Frequency		Horizontal: 31.4-80.0kHz, Vertical: 56-75Hz	
Maximum Resolution		1280 x 1024, 1.3 MegaPixels	
Input Connector		VGA(D-sub) mini 15 pin, DVI-D 24 pin	
Plug & Play		VESA DDC2B™	
Input Sync Signal		Separate sync: TTL, Positive or Negative	
Input Video Signal		Analog: 0.7Vp-p (Standard), 75Ω, Positive Digital: DVI (Digital Visual Interface Standard Rev.1.0) compliance	
Input Audio Connector		ø 3.5mm mini jack (Stereo)	
Input Audio Signal		1.0Vrms maximum	
Speakers		1W x 2 (Stereo speakers)	
Maximum Screen Size		376.5mm W x 301.1mm H / 14.8" W x 11.9" H	
Power Source		100-240VAC, 50/60Hz, 1A	
Power Consumption* ¹		25W typical, Power management mode: 2W maximum	
Dimensions / Net Weight		432.0 x 391.0 x 219.0mm / 17.0 x 15.4 x 8.6" (WxHxD) 6.9kg / 15.2lbs	
Tilt Angle		Upward: 90 degrees Downward: 5 degrees	
Environmental Considerations		Operating: Temperature 0 to 40°C / 32 to 104°F Humidity 20 to 80% (No condensation) Storage: Temperature -20 to 60°C / -4 to 140°F Humidity 10 to 90% (No condensation)	
Approvals		CB, CE, TÜV-Bauart, CU, cULus, VCCI, IP54* ²	

NOTE *¹ USB peripherals / Audio equipment are not connected.

*² IP54 Standard Compliant : Only front face

Model Name		ProLite T1932MSC-B2X
Touch Screen	Technology	Projected capacitive 10pt touch
	Light transmission	90%
	Communication system	USB serial transfer
Size Category		19"
LCD Panel	Driving system	a-Si TFT Active Matrix
	Size	Diagonal: 19" (48cm)
	Pixel pitch	0.294mm H x 0.294mm V
	Brightness	225cd/m ² (Typical: with Touch panel)
	Contrast ratio	1000 : 1 (Typical: with Touch panel)
	Viewable angle	Horizontal : 178 degrees, Vertical: 178 degrees (Typical)
	Response time	14ms (Black, White, Black Typical)
Display Colors		Approx.16.7M
Sync Frequency		Horizontal: 31.4-80.0kHz, Vertical: 56-75Hz
Maximum Resolution		1280 x 1024, 1.3 MegaPixels
Input Connector		VGA(D-sub) mini 15 pin, DVI-D 24 pin
Plug & Play		VESA DDC2B™
Input Sync Signal		Separate sync: TTL, Positive or Negative
Input Video Signal		Analog: 0.7Vp-p (Standard), 75Ω, Positive Digital: DVI (Digital Visual Interface Standard Rev.1.0) compliance
Input Audio Connector		ø 3.5mm mini jack (Stereo)
Input Audio Signal		1.0Vrms maximum
Speakers		1W x 2 (Stereo speakers)
Maximum Screen Size		376.5mm W x 301.1mm H / 14.8" W x 11.9" H
Power Source		100-240VAC, 50/60Hz, 1A
Power Consumption* ¹		20W typical, Power management mode: 2W maximum
Dimensions / Net Weight		432.0 x 391.0 x 219.0mm / 17.0 x 15.4 x 8.6" (WxHxD) 6.9kg / 15.2lbs
Tilt Angle		Upward: 90 degrees Downward: 5 degrees
Environmental Considerations		Operating: Temperature 0 to 40°C / 32 to 104°F Humidity 20 to 80% (No condensation) Storage: Temperature -20 to 60°C / -4 to 140°F Humidity 10 to 90% (No condensation)
Approvals		CB, CE, TÜV-Bauart, CU, cULus, VCCI, IP54* ²

NOTE *¹ USB peripherals / Audio equipment are not connected.

*² IP54 Standard Compliant : Only front face

DIMENSIONS : ProLite T1532MSC

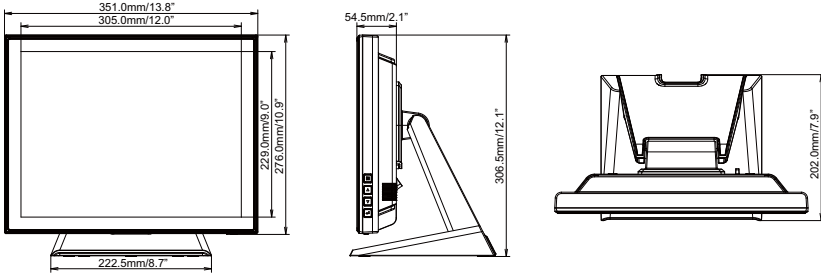

DIMENSIONS : ProLite T1732MSC

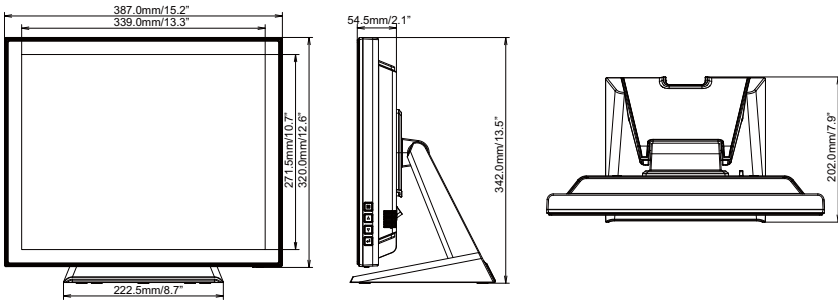

DIMENSIONS : ProLite T1932MSC

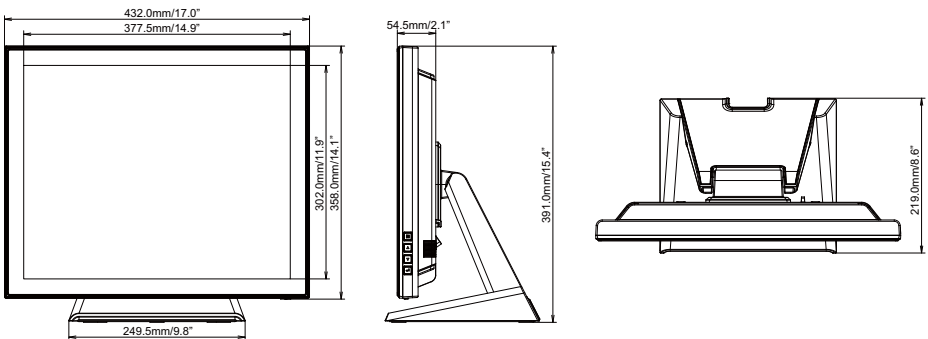

COMPLIANT TIMING

Video Mode		Horizontal Frequency	Vertical Frequency	Dot Clock
VESA	VGA 640 × 480	31.469kHz	59.940Hz	25.175MHz
		37.500kHz	75.000Hz	31.500MHz
		37.861kHz	72.809Hz	31.500MHz
	SVGA 800 × 600	35.156kHz	56.250Hz	36.000MHz
		37.879kHz	60.317Hz	40.000MHz
		46.875kHz	75.000Hz	49.500MHz
		48.077kHz	72.188Hz	50.000MHz
	XGA 1024 × 768	48.363kHz	60.004Hz	65.000MHz
		56.476kHz	70.069Hz	75.000MHz
		60.023kHz	75.029Hz	78.750MHz
	SXGA 1280 × 1024	63.981kHz	60.020Hz	108.000MHz
		79.976kHz	75.025Hz	135.000MHz

NOTE * Not compliant to ProLite T1532MSC.