

SAMSUNG

SM-R600

User Manual

Table of Contents

Getting Started

- 5 About the Gear Sport**
- 6 Read me first**
- 9 Device layout**
 - 9 Package contents
 - 10 Gear
 - 11 Wireless charging dock
- 12 Battery**
 - 12 Charging the battery
 - 14 Battery charging tips and precautions
 - 15 Power saving mode
- 16 Wearing the Gear**
 - 16 Putting on the Gear
 - 16 Band tips and precautions
 - 17 Replacing the band
- 19 Turning the Gear on and off**
- 20 Connecting the Gear to a mobile device**
 - 20 Installing the Samsung Gear app
 - 20 Connecting the Gear to a mobile device via Bluetooth
 - 22 Remote connection
- 23 Using the Gear without a mobile device**

Basics

- 24 Controlling the screen**
 - 24 Screen composition
 - 25 Turning the screen on and off
 - 25 Switching the screen
 - 27 Using the bezel
 - 29 Touchscreen
 - 32 Quick control panel
- 37 Watch**
 - 37 Watch screen
 - 38 Changing the watch face
 - 39 Using the Watch always on feature
 - 39 Watch only mode
- 40 Notifications**
 - 40 Notification panel
 - 40 Viewing incoming notifications
 - 41 Selecting apps for receiving notifications
- 42 Entering text**
 - 42 Introduction
 - 42 Using the voice input
 - 43 Using emoticons
 - 44 Using handwriting input mode or the keyboard
- 45 GPS**
- 46 SOS messages**
- 47 Finding my Gear**

Applications

48 Messages

50 Phone

- 50 Introduction
- 50 Receiving calls
- 52 Making calls

52 Contacts

54 Samsung Pay

55 Samsung Health

- 55 Introduction
- 58 Cal burned
- 59 Steps
- 60 Floors
- 62 Exercise
- 65 Heart rate
- 68 Water
- 69 Caffeine
- 70 Together
- 71 24-hour Log
- 72 Settings
- 72 Additional information

73 Alti-Barometer

76 Music Player

- 76 Introduction
- 76 Playing music
- 76 Importing music
- 77 Playing music with the Gear
- 77 Playing music from your mobile device
- 77 Playing music without connecting to a mobile device

78 Reminder

79 Calendar

79 S Voice

- 79 Introduction
- 79 Setting a wake-up command
- 80 Using S Voice
- 81 Setting the language

81 Weather

81 Alarm

82 World clock

83 Gallery

- 83 Importing and exporting images
- 84 Viewing images
- 84 Deleting images

85 News Briefing

85 Find My Phone

86 Email

86 PPT Controller

- 86 Introduction
- 86 Connecting your Gear to a computer via Bluetooth
- 87 Setting the alarm functions

88 Galaxy Apps

89 Settings

- 89 Introduction
- 89 Watch faces and styles
- 90 Vibration
- 90 Device
- 91 Display
- 91 Connections

- 95 App settings
- 96 Security
- 96 Account and backup
- 97 General management
- 98 Battery management
- 99 About Gear
- 99 Connect to new phone
- 99 Connect to phone

Appendix

109 Troubleshooting

113 Removing the battery

Samsung Gear app

100 Introduction

101 INFO

102 SETTINGS

- 102 Watch faces
- 102 Notifications
- 103 Apps
- 104 Transfer content to Gear
- 104 Send SOS requests
- 105 Find My Gear
- 105 Gear connection
- 106 Quick messages
- 106 Samsung Health
- 106 Samsung Galaxy Apps
- 107 About Gear
- 108 About Samsung Gear app

Getting Started

About the Gear Sport

The Gear Sport is a smartwatch that can analyse your exercise pattern, manage your health and allows you to use a variety of convenient apps for making phone calls, playing music, and managing your health. By rotating the bezel, you can access convenient features quickly and easily. You can also change the watch face to your taste.

Connect your Gear Sport to your mobile device to expand your mobile device experience, or use the Gear Sport by itself, without connecting to a mobile device.



Read me first

Please read this manual before using this device to ensure safe and proper use.

- Descriptions are based on the device's default settings.
- Some content may differ from your device depending on the region, service provider, model specifications, or device's software.
- Content (high quality content) that requires high CPU and RAM usage will affect the overall performance of the device. Apps related to the content may not work properly depending on the device's specifications and the environment that it is used in.
- Samsung is not liable for performance issues caused by apps supplied by providers other than Samsung.
- Samsung is not liable for performance issues or incompatibilities caused by edited registry settings or modified operating system software. Attempting to customise the operating system may cause the Gear or apps to work improperly.
- Software, sound sources, wallpapers, images, and other media provided with this Gear are licensed for limited use. Extracting and using these materials for commercial or other purposes is an infringement of copyright laws. Users are entirely responsible for illegal use of media.
- Default apps that come with the Gear are subject to updates and may no longer be supported without prior notice. If you have questions about an app provided with the Gear, contact a Samsung Service Centre. For user-installed apps, contact service providers.
- Modifying the Gear's operating system or installing softwares from unofficial sources may result in Gear malfunctions and data corruption or loss. These actions are violations of your Samsung licence agreement and will void your warranty.
- Some functions may not work as described in this manual depending on the maker and model of the mobile device you connect to the Gear.

Instructional icons



Warning: situations that could cause injury to yourself or others



Caution: situations that could cause damage to your device or other equipment



Notice: notes, usage tips, or additional information

Maintaining water and dust resistance

Your device supports water- and dust-resistance. Follow these tips carefully to maintain the water- and dust-resistance of your device. Failure to do so may result in damage to your device.

- Do not expose the device to **water moving with force**.
- Do not use your device when you dive into the water, snorkel or try any water sports in fast-flowing water.
- If the device or your hands are wet, dry them thoroughly before handling the device.
- **If the device is dropped or receives an impact**, the water- and dust-resistant features of the device may be damaged.
- Do not disassemble your device. The water- and dust-resistant features of the device can be damaged.
- Do not expose your device to a dramatic change in air temperature or water temperature.
- Do not dry your device with a heating machine like a hair drier.
- The water-resistant feature of the device can be damaged in the sauna.
- Some features such as the touchscreen may not work properly **if the device is used in water**.
- **Your device has been tested in a controlled environment and certified to be water- and dust-resistant in specific situations and conditions. (Meets the requirements of the water-resistance in a 50 m deep water as described by the international standard ISO 22810:2010 and your device can be used in shallow water. Meets the requirements of the dust-resistance as described by classification IEC 60529 IP6X.)**

Cleaning and managing the Gear

Follow the points below to ensure your Gear functions correctly and maintains its appearance. Failure to do so may damage the Gear and cause the skin irritation.

- If the device is exposed to freshwater, dry it thoroughly with a clean, soft cloth. If the device is exposed to any liquid other than freshwater such as perfume, soapy water, oil, pool water, sea water, sun block, or lotion, rinse the device with freshwater and dry it thoroughly with a clean, soft cloth before using your device.
- Do not use soap, cleaning agents, abrasive materials and compressed air when cleaning your Gear and do not clean it with the ultrasonic waves or the external heat sources. Doing so may damage the Gear. Skin irritation may be caused by soap, detergents hand sanitizers, or cleaning agents left on the Gear.
- Clean your wrist and band after exercising or sweating. Clean the Gear with freshwater, wipe it with a little rubbing alcohol and dry your Gear thoroughly.
- When you remove sun block, lotion, or oil, use a soap-free detergent, then rinse and dry your Gear thoroughly.
- If the Gear gets stained or contains any materials, wipe it with a moistened soft bristle toothbrush.

Use caution if you are allergic to any materials on the Gear

- Samsung has tested the noxious materials found on the Gear through the internal and external certificate authorities, including the test for all materials which contact with skin, skin toxicity test, and the Gear-wearing test.
- The Gear includes nickel. Take the necessary precautions if your skin is hypersensitive or you have an allergy to any materials found on the Gear.
 - **Nickel:** The Gear contains a small amount of nickel, which is below its reference point limited by the Europe REACH regulation. You will not be exposed to the nickel inside the Gear and the Gear has passed the international certificated test. However, if you are sensitive to nickel, be careful to use the Gear.
- Only the materials observed the standards of the U.S Consumer Product Safety Commission (CPSC), the regulations of the European countries, and other international standards are used to make a Gear.
- For more information about how Samsung manages chemicals, refer to the Samsung website (<http://www.samsung.com/us/aboutsamsung/sustainability/environment/chemical-management/>).

Device layout

Package contents

Check the product box for the following items:

- Gear
- Wireless charging dock
- Band
- Charger
- Quick start guide



- If the connected band is too large for your wrist, change it to a small one.
- The items supplied with the Gear and any available accessories may vary depending on the region or service provider.
- The supplied items are designed only for this Gear and may not be compatible with other devices.
- Appearances and specifications are subject to change without prior notice.
- You can purchase additional accessories from your local Samsung retailer. Make sure they are compatible with the Gear before purchase.
- Except the Gear, some accessories, such as docking devices, may not have the same water- and dust-resistance certification.
- Use only Samsung-approved accessories. Using unapproved accessories may cause the performance problems and malfunctions that are not covered by the warranty.
- Availability of all accessories is subject to change depending entirely on manufacturing companies. For more information about available accessories, refer to the Samsung website.

Gear

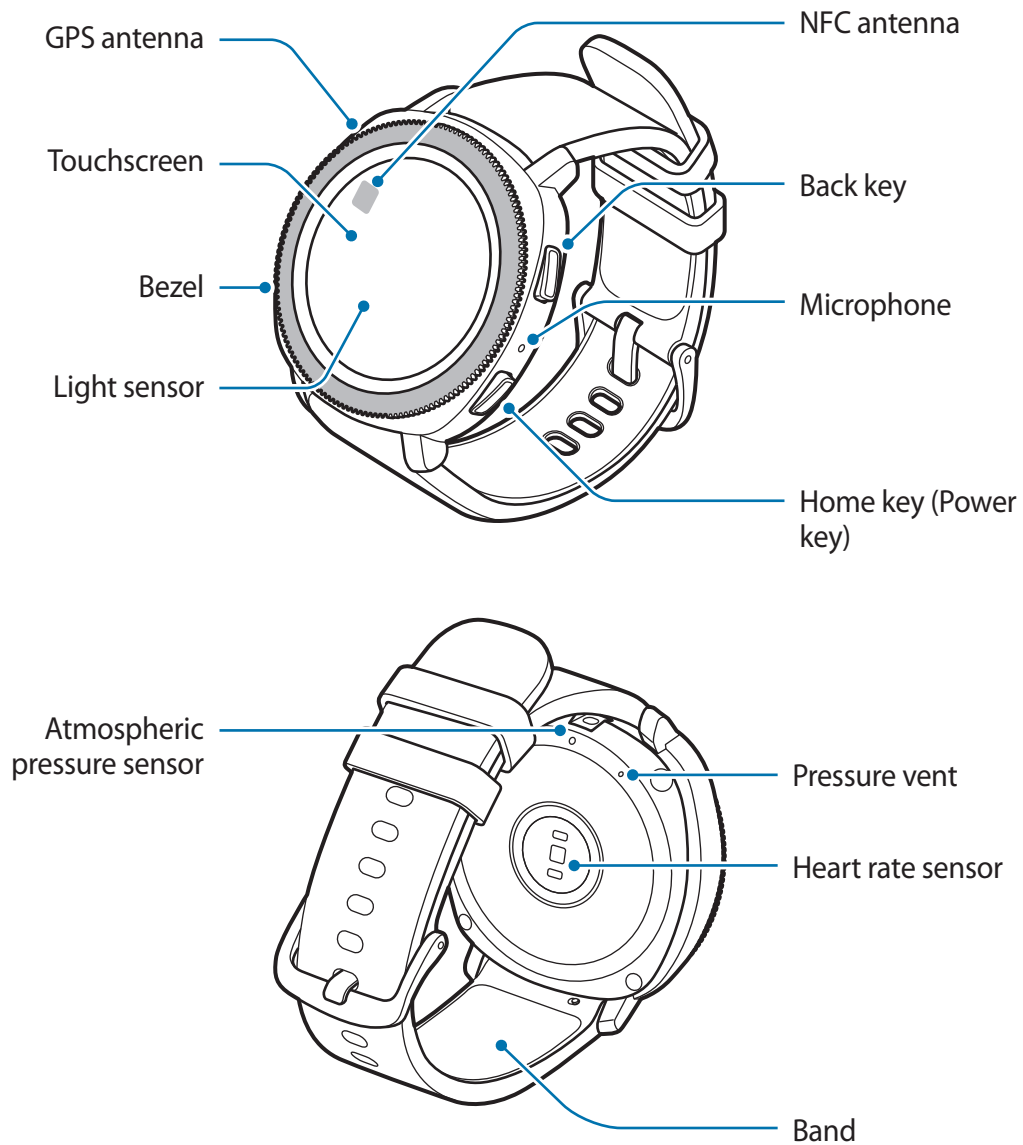



- Ensure that the band is kept clean. Contact with contaminants, such as dust and dye, can cause stains on the band that may not be fully removed.
- Do not insert sharp objects into the atmospheric pressure sensor, the pressure vent, or the microphone. Inner components of the Gear may be damaged along with the water-resistance feature.





Make sure the Gear's microphone is not obstructed when you are speaking into it.

Keys

Key	Function
 Home/Power	<ul style="list-style-type: none"> • Press and hold to turn the Gear on or off. • Press to turn on the screen. • Press and hold for more than 7 seconds to restart the Gear. • Press to open the Apps screen when you are on the Watch screen. • Press to open the Watch screen when you are on any other screen.
 Back	<ul style="list-style-type: none"> • Press to return to the previous screen.

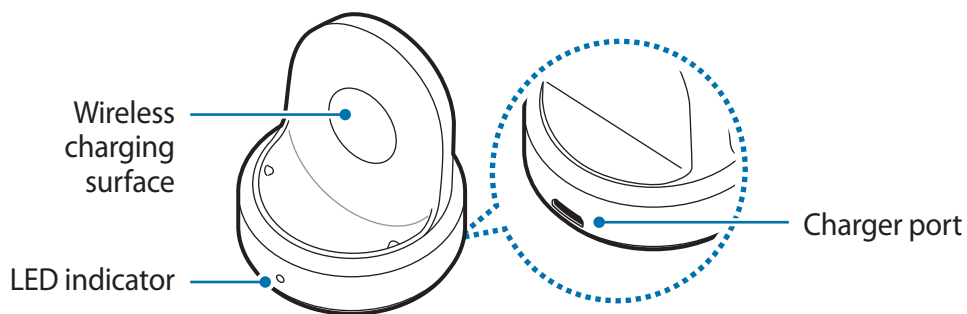
Wireless charging dock



 Do not expose the wireless charging dock to water because the wireless charging dock does not have same water- and dust- resistance certification as your Gear.

Battery

Charging the battery

Charge the battery before using it for the first time or when it has been unused for extended periods.



Use only Samsung-approved chargers, batteries, and cables. Unapproved chargers or cables can cause the battery to explode or damage the Gear.



- Use the supplied wireless charging dock and charger. The Gear cannot be charged properly with a third-party charger.
- Connecting the charger improperly may cause serious damage to the device. Any damage caused by misuse is not covered by the warranty.



To save energy, unplug the charger when not in use. The charger does not have a power switch, so you must unplug the charger from the electric socket when not in use to avoid wasting power. The charger should remain close to the electric socket and be easily accessible while charging.

- 1 Plug the small end of the charger into the charger port of the wireless charging dock and plug the large end of the charger into an electric socket.

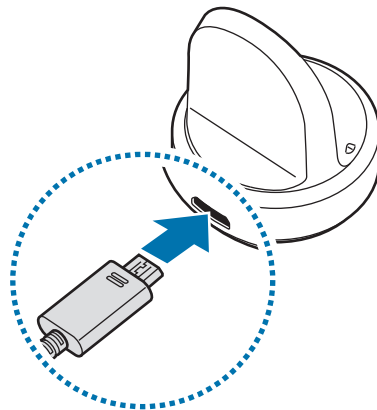

- 2 Place the Gear into the wireless charging dock aligning the centre of your Gear's back side with the centre of the wireless charging dock.

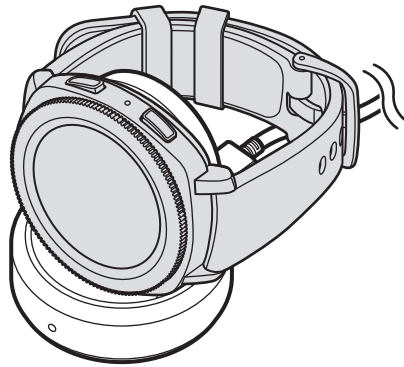

Checking the charging status

When you connect the Gear and the wireless charging dock, the wireless charging dock's LED indicator flashes certain colours to indicate the charging status.

Colour	Charging status
Red	Charging
Green	Fully charged
Orange	Connected to a low-power adaptor



When a wireless charging dock error occurs, the LED indicator flashes red. Disconnect the Gear from the wireless charging dock, wait until the LED indicator stops flashing and reconnect the two. If the error occurs again, contact a Samsung Service Centre for service support.

Reducing the battery consumption

Your Gear provides various options that help you conserve battery power.

- When you are not using the Gear, turn off the screen by covering the screen with your palm.
- Activate power saving mode.
- Close unnecessary apps.
- Deactivate the Wi-Fi feature when not in use.
- Decrease the screen brightness.
- Deactivate the watch always on feature.
- Deactivate the voice wake-up feature in the **S Voice** app.
- Customise the notification settings in **Samsung Gear** on the mobile device.
- Turn off the GPS feature.
- Set the Auto HR feature to **Frequent** or **Never**.

Battery charging tips and precautions





- If there are obstructions between the Gear and the wireless charging dock, the Gear may not charge properly. Prevent the Gear and the wireless charger from coming into contact with sweat, liquids, or dust.
- When the battery power is low, the battery icon appears empty.
- If the battery is completely discharged, the Gear cannot be turned on immediately when the charger is connected. Allow a depleted battery to charge for a few minutes before turning on the Gear.
- If you use multiple apps at once, the battery will drain quickly. To avoid losing power during a data transfer, always use these apps after fully charging the battery.
- Using a power source other than the charger, such as a computer, may result in a slower charging speed due to a lower electric current.
- If the Gear is being charged with other devices via a multicharger, charging may take longer.



- The Gear can be used while it is charging, but it may take longer to fully charge the battery.
- If the Gear receives an unstable power supply while charging, the touchscreen may not function. If this happens, disconnect the Gear from the wireless charging dock.
- While charging, the Gear may heat up. This is normal and should not affect the Gear's lifespan or performance. If the battery gets hotter than usual, the charger may stop charging.
- If the Gear is not charging properly, take the Gear to a Samsung Service Centre.
- Avoid using a bent or damaged USB cable. If the USB cable is damaged, stop using it.

Power saving mode

Activate power saving mode to extend the battery's usage time.

- Displays colours on the screen as grey tones.
- Deactivates features, excluding phone, messages, and notifications.
- Deactivates the Wi-Fi feature.
- Limits the performance of the Gear's CPU.

On the Gear's Apps screen, tap  (**Settings**) → **Battery management** → **Power saving** → . Or, tap  →  on the quick control panel to activate power saving mode. For more information about how to open the quick control panel, refer to [Quick control panel](#).

To deactivate this mode, tap **OFF** → . Or, tap  →  on the quick control panel to deactivate power saving mode.

Wearing the Gear

Putting on the Gear

Open the buckle and place the band around your wrist. Fit the band to your wrist, insert the pin into an adjustment hole, and then secure the buckle to close it.

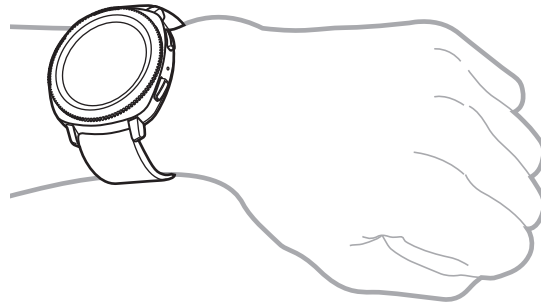

Do not bend the band excessively. Doing so may damage the Gear.



To measure your heart rate more accurately with the Gear, wear the Gear firmly around your lower arm just above the wrist. Refer to [Wearing the Gear correctly](#) for details.

Band tips and precautions

- When you wear the Gear for a long time, skin irritation may occur due to friction and pressure. If you wearing your Gear for a long time, remove the Gear from your wrist and do not wear your Gear for several hours.
- Skin irritation may occur due to an allergy, environment factors, other factors, or when your skin is exposed to soap or sweat for long periods. In this case, stop using your Gear and wait 2 or 3 days for the symptoms to ease. If the symptoms persist or worsen, immediately call your doctor.
- Make sure your skin is dry before wearing your Gear. If you wear a wet Gear for a long time, your skin may be affected.
- If you use your Gear in the water, remove foreign materials from your skin and Gear and dry them thoroughly to prevent the skin irritation.
- Do not use any accessories except the Gear in the water.

Replacing the band

Detach the band from the Gear to replace it with a new one.

- 1 Slide the band's spring bar inwards.

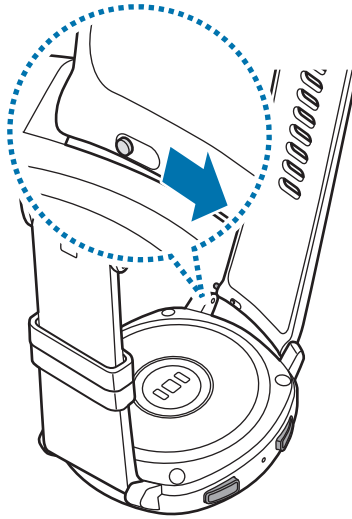

- 2 Pull the band away from the Gear's body.

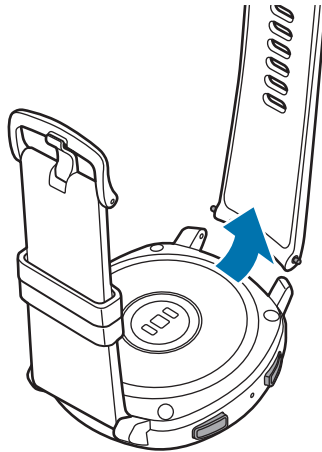

- 3 Insert one end of the spring bar into the Gear's lug.

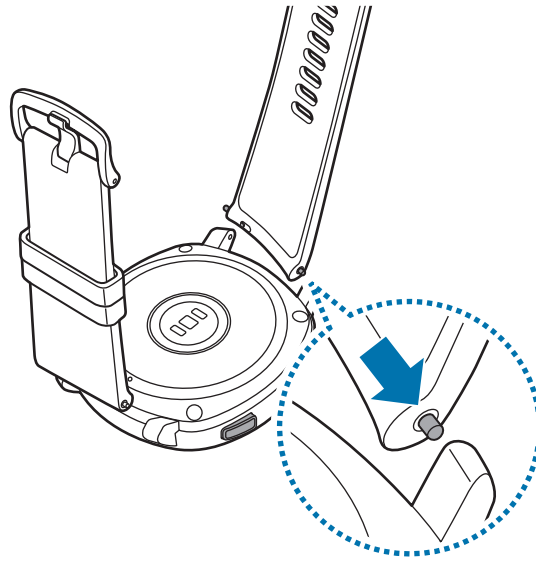

- 4 Slide the spring bar inwards and connect the band.

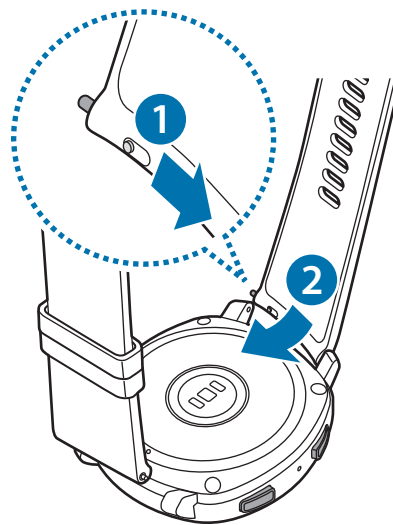

Turning the Gear on and off

Press and hold the Home key (Power key) for a few seconds to turn on the Gear.

When you turn on the Gear for the first time or reset it, on-screen instructions will appear to download and install the Samsung Gear app on your mobile device. Refer to [Connecting the Gear to a mobile device](#) for details.

To turn off the Gear, press and hold the Home key (Power key), and then tap **Power off**.

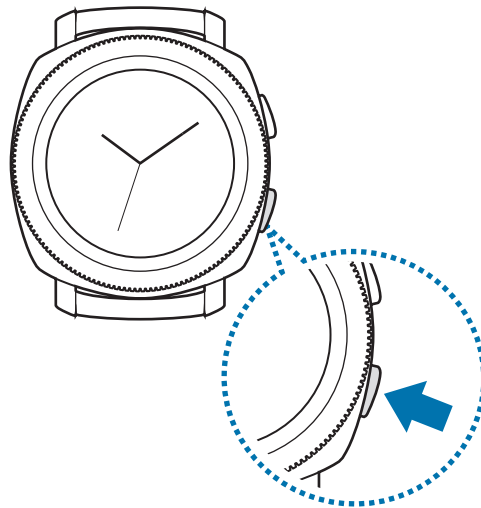

Follow all posted warnings and directions from authorised personnel in areas where the use of wireless devices is restricted, such as aeroplanes and hospitals.

Restarting the Gear

If your Gear is frozen and unresponsive, press and hold the Home key (Power key) for more than 7 seconds to restart it.

Connecting the Gear to a mobile device

Installing the Samsung Gear app

To connect your Gear to a mobile device, install the Samsung Gear app on the mobile device. Depending on your mobile device, you can download the Samsung Gear app from the following places:

- Samsung Android devices: **Galaxy Apps, Play Store**
- Other Android devices: **Play Store**



You cannot install the Samsung Gear app on the mobile devices that do not support Gear syncing. Ensure that your mobile device is compatible with a Gear.

Connecting the Gear to a mobile device via Bluetooth

Gear

- 1 Turn on the Gear.
- 2 Select a language to use and tap **NEXT**.

A screen will appear about downloading and installing the Samsung Gear app.



If you want to use your Gear without connecting it to a mobile device, refer to [Using the Gear without a mobile device](#).

Mobile device

- 3 Launch **Samsung Gear**.

If necessary, update the Samsung Gear app to the latest version.

- 4 Tap **START THE JOURNEY**.

5 Select your Gear type on the screen.

If you cannot find your Gear type, tap **MINE'S NOT HERE**.

6 Tap **TURN ON** when the Bluetooth activation request window appears.

7 Follow the on-screen instructions to complete the connection.

When the devices are connected, an on-screen tutorial will appear on the Gear's screen. Follow the on-screen instructions to learn the Gear's basic controls.

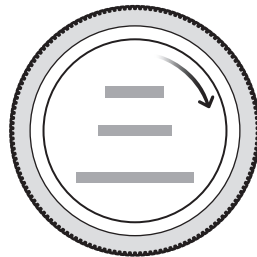

- Connection methods and screen may vary depending on your mobile device and software version.
- When you connect your Gear to a mobile device for the first time after resetting it, the Gear's battery may drain more quickly while syncing data, such as contacts.
- Supported mobile devices and features may vary depending on your region, service provider, and device manufacturer.

Connecting the Gear to a new mobile device

When you connect the Gear to your new mobile device, on-screen instructions will ask you to reset the Gear. Make sure you back up any important data stored in your Gear before connecting your Gear to a new mobile device. For more information about backing up your Gear, refer to [Backing up and restoring data](#).

- 1 On your Gear, open the Apps screen, tap  (**Settings**) → **Connect to new phone** → .

The connection between your Gear and your mobile device will end. After a light reset, it will automatically enter Bluetooth pairing mode.

- 2 On your new mobile device, launch **Samsung Gear** to connect to your Gear.



If the mobile device you want to connect to is already connected to another Gear, your Gear cannot establish a connection. Disconnect your mobile device from the previous Gear to connect to your current Gear.

Remote connection

Your Gear and mobile device are connected via Bluetooth. When a Bluetooth connection is not available, you can remotely connect the Gear to your mobile device by using your Samsung account via Wi-Fi network. This allows you to continue receiving notifications from your mobile device.

This feature is automatically activated when you connect to your mobile device via Bluetooth for the first time.





If this feature is not turned on, launch **Samsung Gear** on your mobile device, tap **SETTINGS** → **Gear connection**, and then tap the **Remote connection** switch.

Using the Gear without a mobile device

You can use the Gear without connecting it to a mobile device. You can set to use the Gear without a mobile device when you turn on the Gear for the first time or you reset it.



- Some features are not available when you using your Gear without connecting to a mobile device.
- Visit www.samsung.com to view legal notices provided when setting Without phone connection mode for the first time.

- 1 Turn on the Gear.
 - 2 Select a language and tap **NEXT**.
 - 3 Tap , scroll down the screen, and tap **here**.
 - 4 Check the notice and read the terms and conditions, and then agree to them.
 - 5 Login with your Samsung account.
 - 6 If you need to restore data, restore another Gear's data stored in your Samsung account.
 - 7 Set a time zone.
 - 8 Set a PIN for restoring or backing up data.
-  On the Gear, open the Apps screen, tap  (**Settings**) → **Connect to phone** → **NEXT** →  to connect the Gear to a mobile device while using the Gear without a mobile device.

Basics

Controlling the screen

Screen composition

The Watch screen is the starting point for accessing all of the Gear's many screens.

You can view other screens by pressing the button, rotating the bezel, or swiping your finger on the screen.

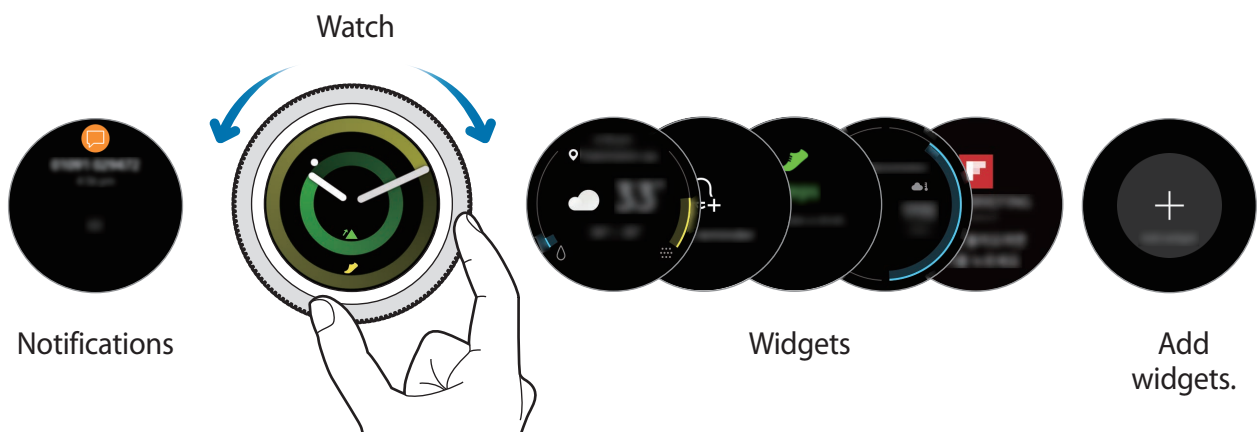

Available widgets, notifications, and their arrangement may vary depending on the software version.

Adding widgets

You can add more widgets on the Home screen.

Scroll the screen, tap , and select a widget. The selected widget will appear in a new panel.

Moving widgets

Tap and hold a widget and then drag it to the desired location.

Removing widgets

Tap and hold a widget and then tap .

Turning the screen on and off

To turn on the screen, rotate the bezel. Or, press the Home key or the Back key.

If the screen does not turn on after you rotate the bezel, tap  (**Settings**) on the Gear's Apps screen and tap **Device** → **Bezel wake-up** → **Bezel wake-up** to activate the feature.

To turn off the screen, cover it with your palm. Also, the screen will automatically turn off if the Gear is not used for a specified period.

You can also turn on the screen using the wake-up gesture feature. On the Gear's Apps screen, tap  (**Settings**) → **Device** → **Wake-up gesture** → **Wake-up gesture** to activate it.

Switching the screen

Switching between the Watch and Apps screen

To open the Apps screen, press the Home key on the Watch screen.

To return to the Watch screen, press the Home key.

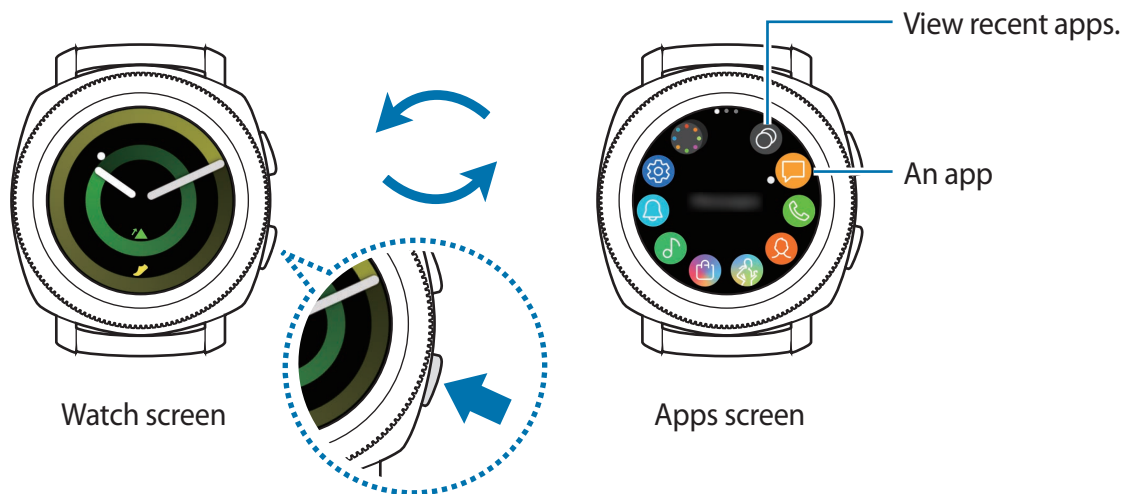

Apps screen

The Apps screen displays icons for all apps.

To view other panels, rotate the bezel or swipe the screen to the left or right.



The available apps may vary depending on the software version.

Opening apps

On the Apps screen, tap an app icon to open the app.

To open an app from the list of recently used apps, tap  (**Recent apps**) on the Apps screen.



You can launch apps directly after adding the **App shortcuts** widget and add the frequently used apps. Tap  and add the app you want. For more information about adding widgets, refer to [Adding widgets](#).

Closing apps

1 On the Apps screen, tap  (**Recent apps**).

2 Rotate the bezel or swipe the screen to the left or right to highlight the app you want to close.

3 Tap .

To close all running apps, tap **CLOSE ALL**.

Returning to the previous screen

To return to the previous screen, press the Back key.

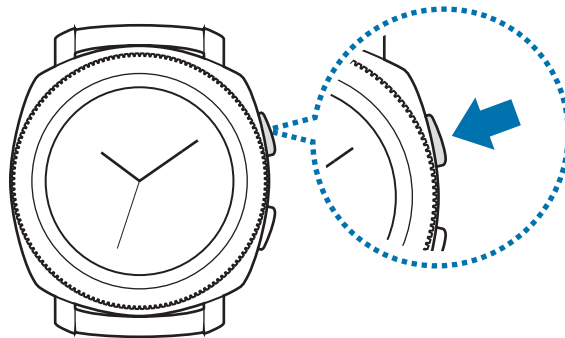

Using the bezel

Rotate the bezel to easily control the Gear's various functions.



- Make sure the bezel area is free from the foreign materials like dust or sand.
- Do not use the bezel near magnetic fields as they may interfere with the bezel's internal magnets and cause it to malfunction.



If the bezel does not rotate, take it to a Samsung Service Centre without disassembling the Gear.

Scrolling through screens

Rotate the bezel to view other screens. On the Watch screen, rotate the bezel anticlockwise to view notifications.

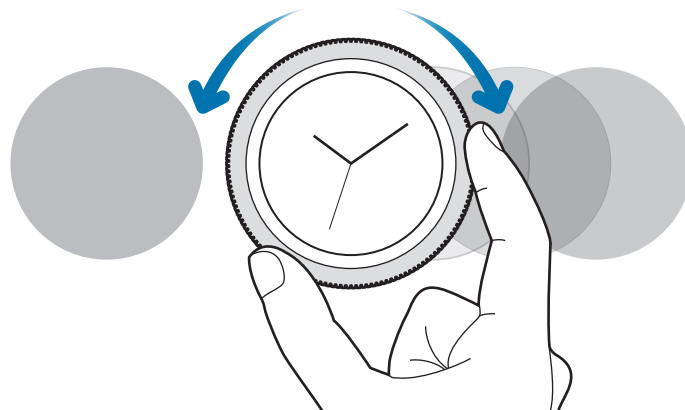

Selecting an item

Rotate the bezel to move from item to item. When you rotate the bezel, the highlight indicator will move in same direction and an item will be highlighted.

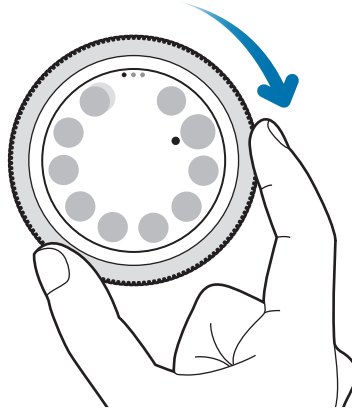

Adjusting the input value

Rotate the bezel to adjust the volume or brightness. When adjusting the brightness, rotate the bezel clockwise to make the screen brighter.

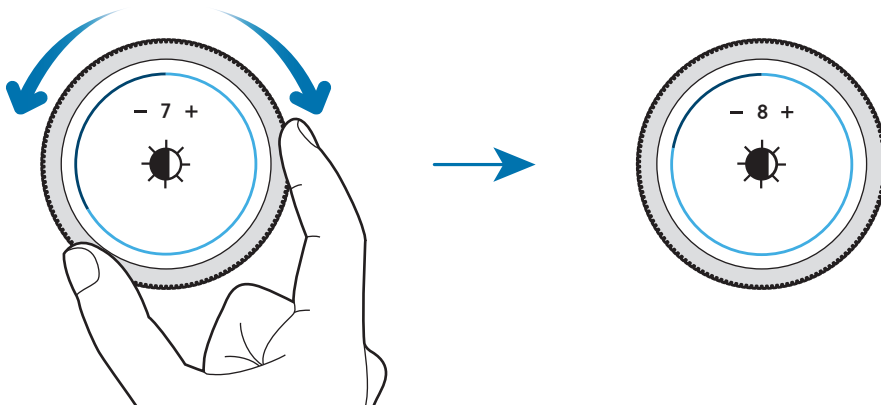

Receiving or rejecting incoming calls

Rotate the bezel clockwise to receive an incoming call or to dismiss an alarm. Rotate the bezel anticlockwise to reject an incoming call or to activate the snooze feature for an alarm.

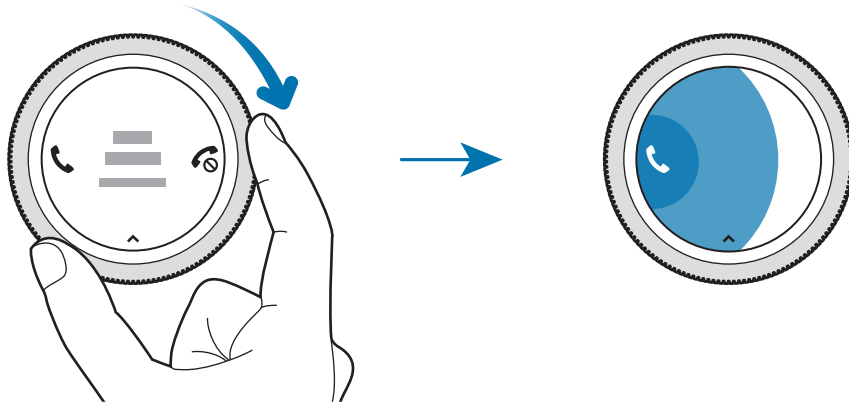

Touchscreen



- Do not allow the touchscreen to come into contact with other electrical devices. Electrostatic discharges can cause the touchscreen to malfunction.
- To avoid damaging the touchscreen, do not tap it with anything sharp or apply excessive pressure to it with your fingertips.



- The Gear may not recognise touch inputs close to the edges of the screen, which are outside of the touch input area.
- It is recommended to use fingers when you use the touchscreen.
- The touchscreen may not be available when water lock mode is activated.

Tapping

To open an app, to select a menu item, or to press an on-screen button, tap it with your finger.

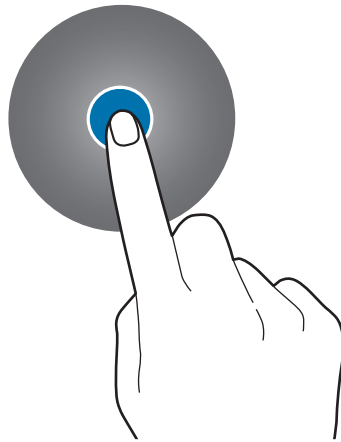

Tapping and holding

Tap and hold the screen for two or more seconds to access the Edit mode or to view available options.

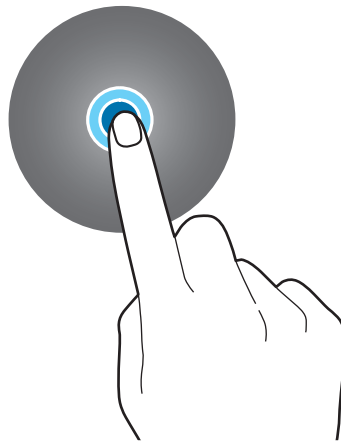

Dragging

To move an item, tap and hold it and drag it to the target position.

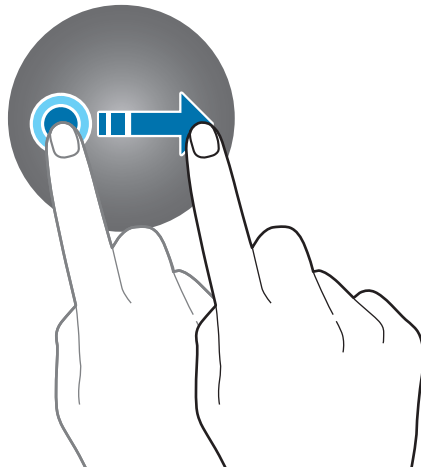

Double-tapping

Double-tap on an image to zoom in. Double-tap again to return.

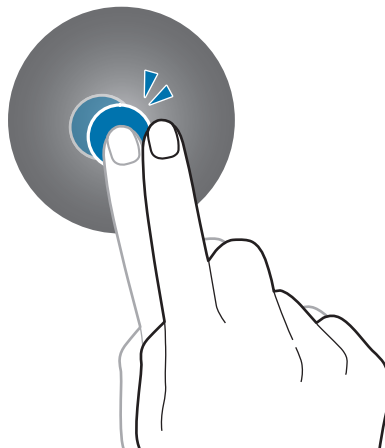

Swiping

Swipe to the left or right to view other panels.

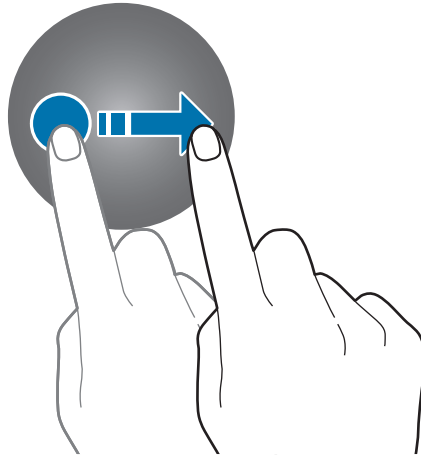

Quick control panel

This panel allows you to view the Gear's current status and configure basic settings.

Swipe downwards from the top edge of the screen.

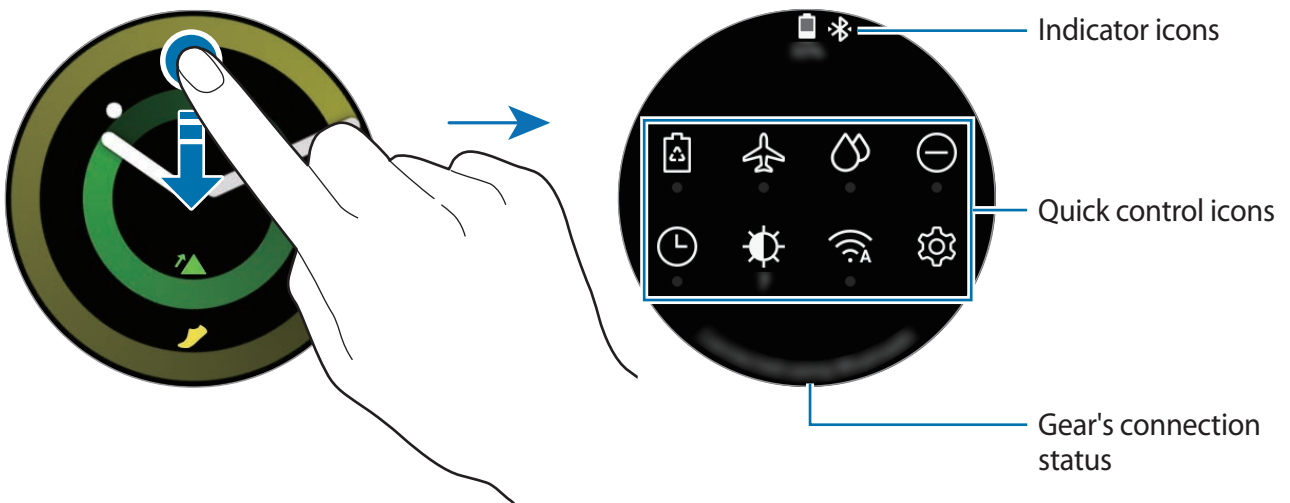

Checking the indicator icons

Indicator icons appear at the top of the quick control panel and let you know the Gear's current status. The icons listed in the table below are most common.



The indicator icons shown may vary depending on the region.

Icon	Meaning
	Bluetooth connected
	Bluetooth disconnected
	Bluetooth headset connected
	Wi-Fi connected
	Battery power level

Checking quick control icons

Icon	Meaning
	Activate power saving mode
	Activate flight mode
	Activate water lock mode
	Activate do not disturb mode
	Activate the watch always on feature
	Adjust the brightness
	Play or pause music
	Open the settings screen
	Activate the NFC feature
	Activate vibrate or silent mode
	Wi-Fi network connected or Wi-Fi network automatically connected
	Activate the touch sensitivity feature
	Open the battery management menu
	Activate the location information feature

Editing the quick control icons

You can edit the quick control icons on the quick control panel and up to eight quick control icons can be added. You can add a new icon only after removing one if eight icons have already been added.

Removing a quick control icon

Tap and hold a quick control icon you want to delete on the quick control panel and tap . The quick control icon will be removed.

Adding a quick control icon

Tap and hold a quick control icon and tap , then select a feature you want to add on the quick control panel.

The quick control icon for the feature you select will be added on the quick control panel.

Activating power saving mode

Activate power saving mode to restrict some Gear features and reduce the battery usage.

On the quick control panel, tap .

Once enabled, colours will appear in grey tones.

Refer to [Power saving mode](#) for more information.

Activating the flight mode

You can activate the flight mode when you board an aeroplane. Activating this feature will restrict apps that require an network connection, but allow you to use other apps and features as normal.

On the quick control panel, tap .

The  icon will appear at the top of the Watch screen.

Activating water lock mode

You can activate water lock mode when you exercise in water.

On the quick control panel, tap .

The touchscreen, the wake-up gesture feature, and the watch always on feature will be deactivated.

Press and hold the Home key until the circle disappears to turn off water lock mode.

Activating the do not disturb mode

When a notification, except an alarm, is received, you can set your Gear not to vibrate and not to turn on the screen.

On the quick control panel, tap  and set do not disturb mode.

The  icon will appear at the top of the Watch screen.

Activating the watch always on feature



You can set the screen to turn on even though you are not using your Gear while wearing it.

On the quick control panel, tap .

If you activate this feature, the battery will drain more quickly than normal.



Adjusting the brightness

You can adjust the Gear's display brightness to suit the environment.

On the quick control panel, tap  and adjust the brightness by rotating the bezel, or tap  or .

Playing or pausing music

Play or pause music.

On the quick control panel, tap  or .

Music is played or paused from the connected mobile device. You can listen to music after connecting the Bluetooth headset.

Opening the Settings screen

Open the Setting screen to configure the Gear's various features and apps.

On the quick control panel, tap .

The Settings screen will appear.

Activating the NFC feature

Activate the NFC feature to make payments.

On the quick control panel, tap .

The NFC feature will be activated and you make payments easily with the NFC antenna. For more information, refer to [NFC](#).

Activating vibrate or silent mode

Activate vibrate or silent mode.

On the quick control panel, tap  or .

Connecting to a Wi-Fi network

Connect to a Wi-Fi network manually or set the Wi-Fi network to connect automatically.

On the quick control panel, tap  or .

The Wi-Fi network will be connected or disconnected. To set the Wi-Fi network to connect automatically, tap the Wi-Fi icon until  appears.

Activating the touch sensitivity feature

Activate the touch sensitivity feature to use the touchscreen while wearing gloves.

On the quick control panel, tap .



Depending on the type of gloves, the touchscreen might not recognise your touch and the feature may not activate.

Opening the battery management menu

Open the battery management menu to manage the battery consumption easily.

On the quick control panel, tap .

The battery management menu will be appear.

Activating the location information feature

Activate the location information to use GPS data and location data with certain apps.

On the quick control panel, tap .

Watch

Watch screen

View the current time. When you are not on the Watch screen, press the Home key to return to the Watch screen.



Changing the watch face

Tap and hold the Watch screen and rotate the bezel, or swipe the screen to the left or right and then select a watch face. You can also customise the watch by tapping **CUSTOMISE**. To download more watch faces from **Galaxy Apps**, tap **Galaxy Apps**.

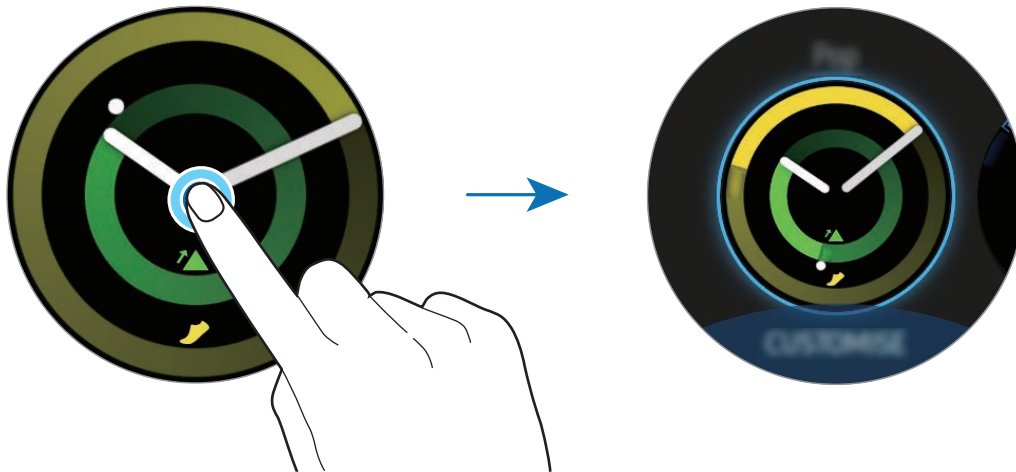

Tap and hold the Watch screen and rotate the bezel rapidly. The available watch faces will appear on the screen allowing you to select them easily. However, the **CUSTOMISE** feature is unavailable.

You can also change the Gear's watch face from your mobile device. Launch **Samsung Gear** on your mobile device and tap **SETTINGS** → **Watch faces**. To download more watch faces from **Galaxy Apps**, launch **Samsung Gear** and tap **INFO** → **VIEW MORE WATCH FACES**.

Customise a watch face with a photo

Apply a photo as your watch face after importing a photo from your mobile device. For more information about importing photos from a mobile device, refer to [Importing images from your mobile device](#).

- 1 Tap and hold the Watch screen and rotate the bezel, or swipe the screen to the left or right and tap **CUSTOMISE** of the **My Photo+** watch face.
- 2 Tap the screen and tap **Add photo**.

3 Select the photo to apply as your watch face and tap **OK** → **OK**.



To add extra photos, rotate the bezel clockwise, or swipe the screen to the left and select **Add photo**. Up to ten photos can be added as the watch face. The photos you add will rotate in chronological order.

4 Tap **OK**.

Using the Watch always on feature

You can set the Gear to display the time when the screen is turned off while wearing your Gear.

On the Apps screen, tap  (**Settings**) → **Watch faces and styles** → **Watch always on** to activate it.

Watch only mode

You can activate watch only mode. In watch only mode, only the watch will display and all other functions will be turned off. For more information about switching to watch only mode, refer to [Battery management](#).

Notifications

Notification panel

Check a notification such as a new message or a missed call on the notification panel. On the Watch screen, rotate the bezel anticlockwise to open the notification panel. When there are unchecked notifications, a yellow dot will be visible on the Watch screen.

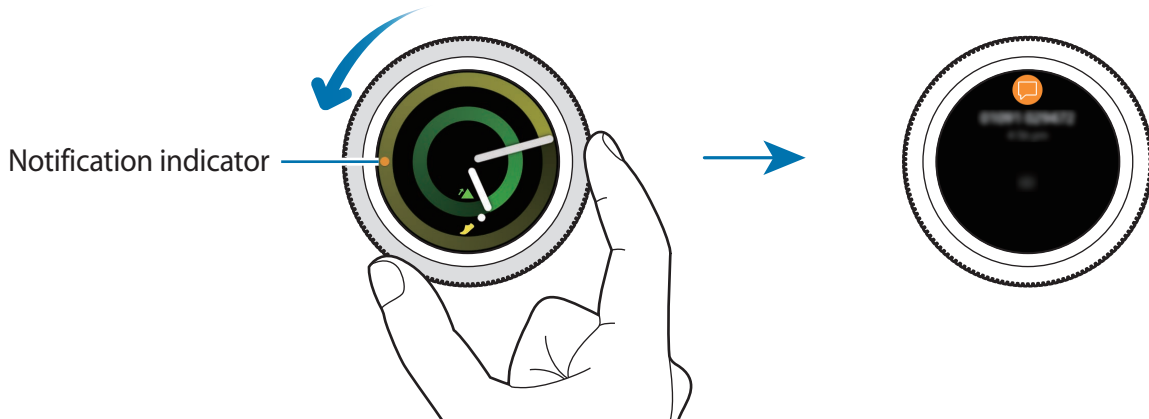

Viewing incoming notifications

When you receive a notification, information about the notification, such as its type, will appear on the screen. Tap the notification to view details.

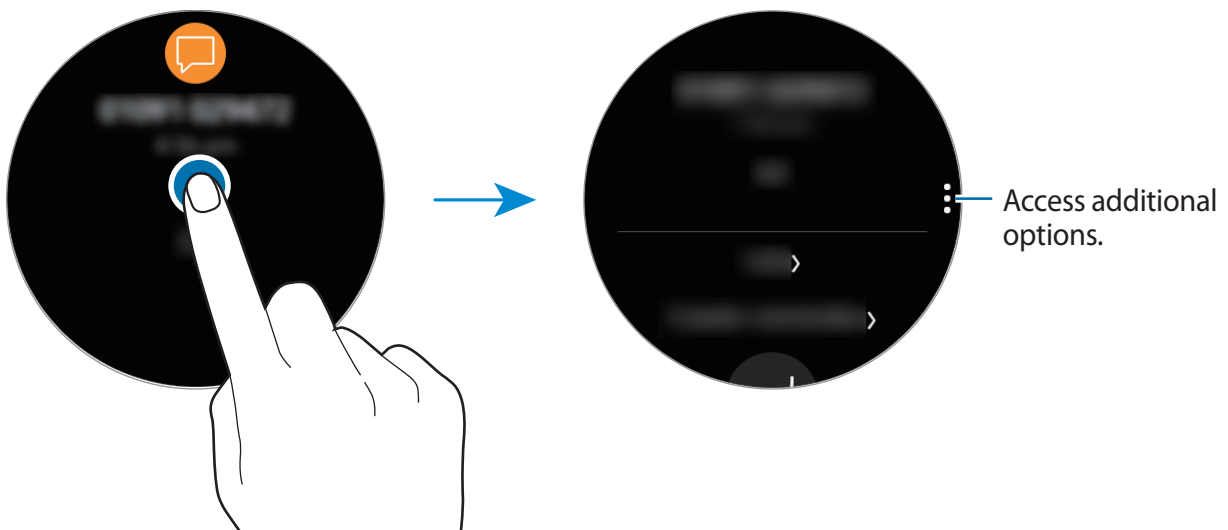

To view more notifications received from other apps, rotate the bezel anticlockwise.

Deleting notifications

Delete a notification by swiping upwards from the bottom edge of the screen while viewing a notification.

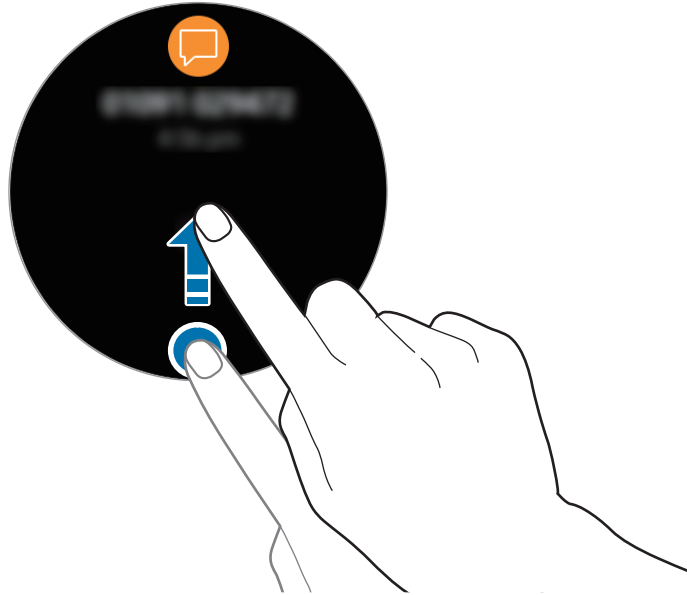

Selecting apps for receiving notifications

Select an app from your mobile device to receive notifications.

- 1 Launch **Samsung Gear** on your mobile device and tap **SETTINGS** → **Notifications**, and tap the switch.
- 2 Tap **Manage notifications** and tap the switch next to apps to receive notifications from them on your Gear.

Entering text

Introduction

A text input screen will appear when you are able to enter text.



- The screen layout may be different depending on the app you launch.
- When the Gear is connected to a mobile device via Bluetooth, the language settings applied on the mobile device are applied to the Gear.

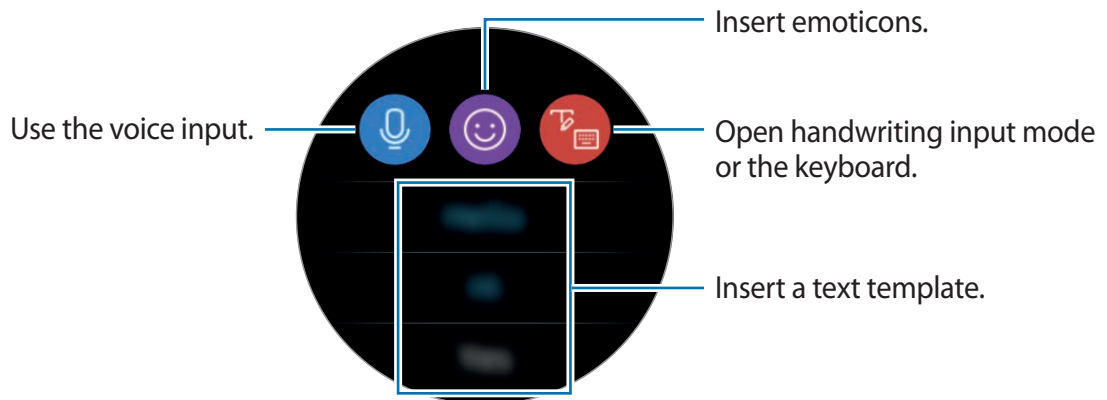

Using the voice input

Tap  and speak to enter your message.

To change the language recognised, tap  → **Input languages**.

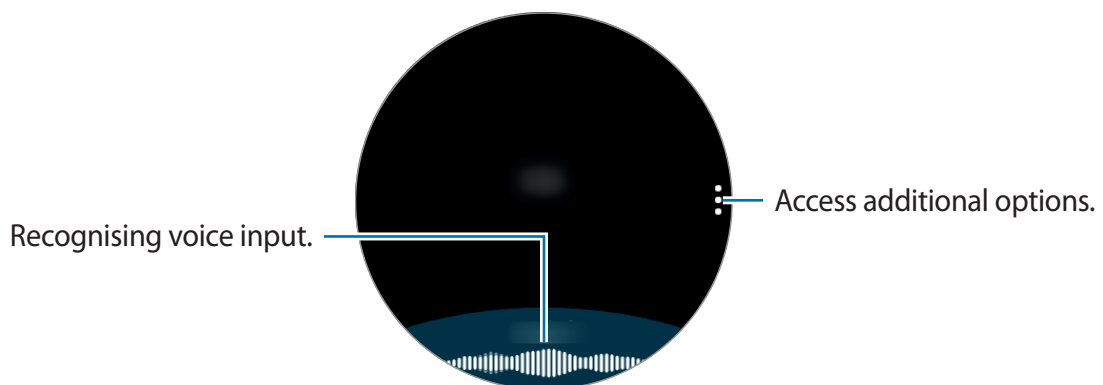



- This feature is not supported in some languages.

- **Tips for better voice recognition**

- Speak clearly.
- Speak in quiet places.
- Do not use offensive or slang words.
- Avoid speaking in dialectal accents.

The Gear may not recognise your spoken message depending on your surroundings or how you speak.

Using emoticons

Tap  and select the emoticon you want to send. To draw a picture, tap **Doodle** at the top of the screen, and draw your message.

Rotate the bezel anticlockwise to delete the input stroke by stroke. To recover a stroke, rotate the bezel clockwise.

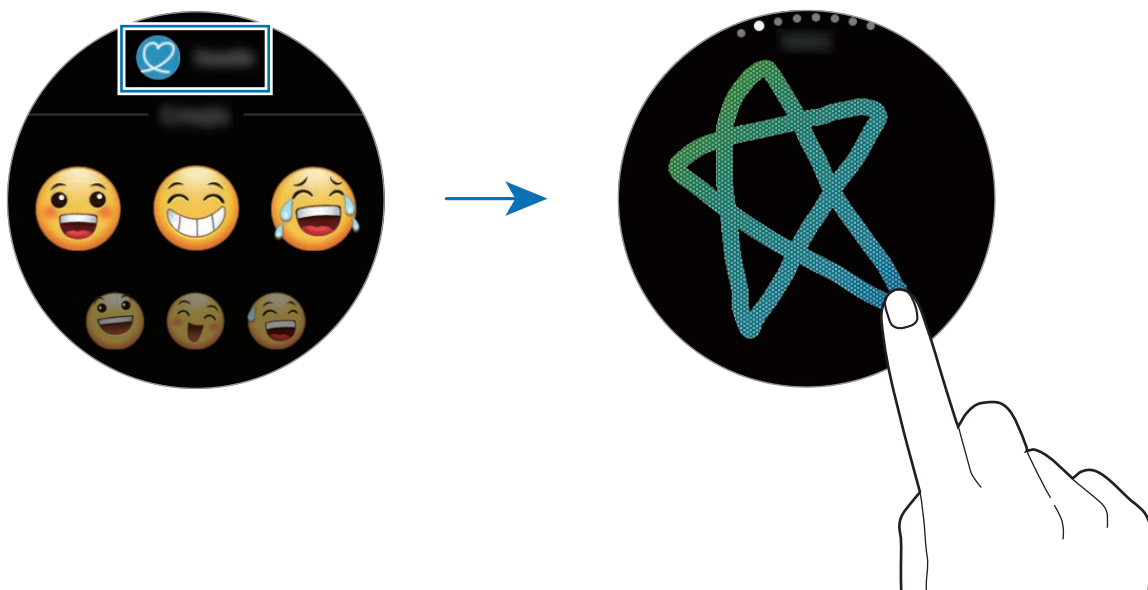

Using handwriting input mode or the keyboard

Tap  and open handwriting mode and write on the screen.

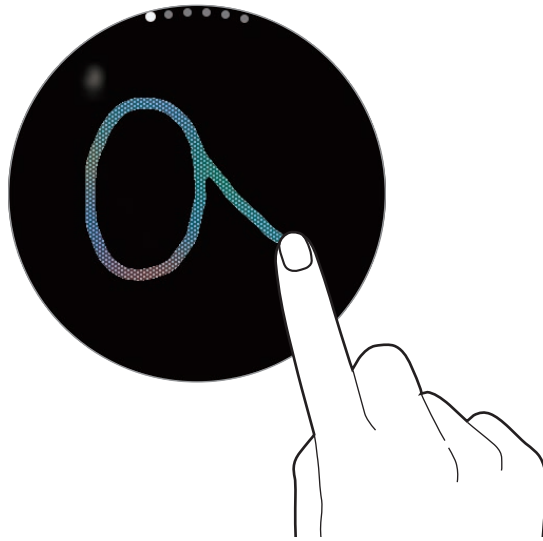

This feature may not be available depending on the region.

Changing the input mode

Rotate the bezel to change the input mode on the text input screen. You can switch between handwriting mode, character mode, number mode, punctuation mode, emoticon mode, and voice input mode.

Changing the input language

Drag the space key to the left or right while tapping and holding it to change the input language.

To add more languages, switch to number mode, punctuation mode, or emoticon mode.

Then, tap  → **Select input languages** and select a language to add. You can use up to two languages.

Using the keyboard

Rotate the bezel to enter text using the keyboard.



- Text entry is not supported in some languages. To enter text, you must change the input language to one of the supported languages.
- The keyboard layout may differ depending on the region.

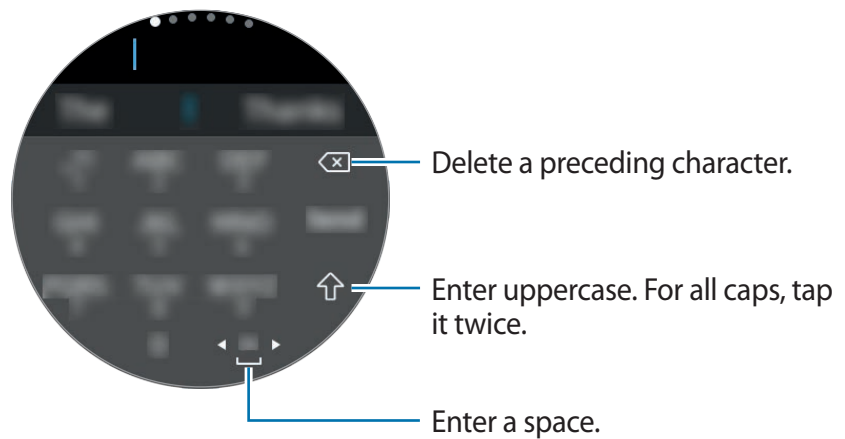

GPS

The Gear has a GPS sensor so that you can check your real-time location information without connecting to a mobile device. When you are using your Gear without connecting to a mobile device or using apps such as **Alti-Barometer**, the GPS sensor in your Gear will be used. Also, you allow others to track your location by sending an SOS message in an emergency.

On the Apps screen, tap  (**Settings**) → **Connections** → **Location** → **Location** to activate it. To select a method to use for locating, scroll down the screen and select an option.

When your Gear and mobile device are connected, this feature uses your mobile device's GPS. Activate the mobile device's location feature to use the GPS sensor.



- GPS signal strength may decrease in locations where the signal is obstructed, such as between buildings or in low-lying areas, or in poor weather conditions.

SOS messages

In an emergency situation, you can send an SOS message by quickly pressing the Gear's Home key three times.

Setting up SOS messages

- 1 Launch **Samsung Gear** on your mobile device and tap **SETTINGS** → **Send SOS requests**, and tap the switch to activate it.
- 2 Follow the on-screen instructions to add emergency contacts if you have not already done so.

Adding emergency contacts

Launch **Samsung Gear** on your mobile device and tap **SETTINGS** → **Send SOS requests** → **Send SOS messages to** → **ADD**.

Tap **Create contact** and enter the contact information or tap **Select from Contacts** to add an existing contact as an emergency contact.

Setting the SOS message delay

Set the Gear to send an SOS message after a while when you quickly press the Gear's Home key three times.

Launch **Samsung Gear** on your mobile device and tap **SETTINGS** → **Send SOS requests**. Tap the **Count down before sending** switch to activate it.

Sending SOS messages

In an emergency situation, quickly press the Gear's Home key three times.

The Gear will send SOS messages to your emergency contacts. The messages will include your current location information and a link to track your real-time location information for 60 minutes.

After sending an SOS message, the  icon will display on the Watch screen. Swipe to the right to view the result of your SOS request.

Viewing my location

After sending an SOS message which includes your location information, you can view your location on the notification panel. On the Watch screen, swipe to the right or rotate the bezel anticlockwise and tap the screen to view your current location on the map.

To finish sharing your location with your emergency contacts, scroll down the screen, and tap  (Stop sharing) → .

Finding my Gear



If you misplace your Gear, use the Samsung Gear app on your mobile device to find it.



Register your Samsung account on the connected mobile device first to use this feature.

1 Launch **Samsung Gear** on your mobile device and tap **SETTINGS** → **Find My Gear**.

2 Tap .

The Gear will vibrate and the screen will turn on. Drag  outside the large circle on the Gear, or rotate the bezel clockwise, or tap  on the mobile device to stop vibration.

When your Gear is lost or stolen, you can control it remotely. Launch **Samsung Gear** on your mobile device and tap **SETTINGS** → **Find My Gear** → **Control remotely**, and tap the switch to activate it.

Applications

Messages

View messages and reply to using the Gear.

Viewing messages



You may incur additional charges for receiving messages while you are roaming.

1 Tap  (**Messages**) on the Apps screen.

Or, swipe to the right on the Watch screen or rotate the bezel anticlockwise when you receive a new message notification.

2 Scroll through the message list, and then select a contact to view your conversations.

To view a message on your mobile device, tap , rotate the bezel and tap **Show on phone**.

To reply to a message, tap  (**Reply**) and enter your message. Or, you can also reply to a message by rotating the bezel clockwise.

Sending messages



You may incur additional charges for sending messages while you are roaming.

- 1 Tap  (**Messages**) on the Apps screen.

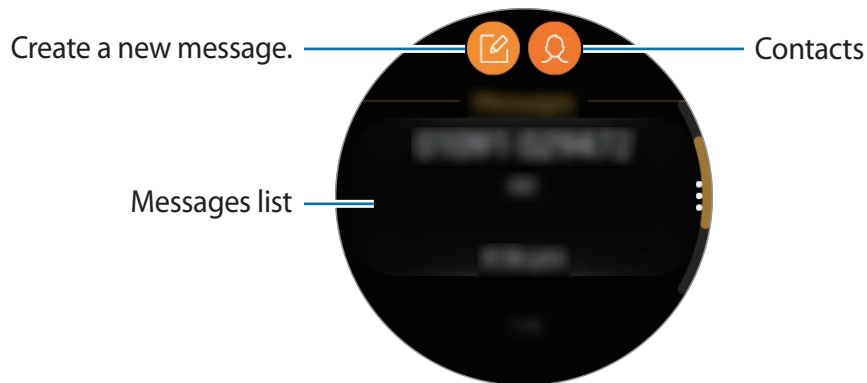

- 2 Tap .

Or, you can choose a message recipient by tapping  on the contacts list.

- 3 Add a recipient and tap **NEXT**.

- 4 Enter text using one of available methods and tap **SEND** or **Send**.

When you select a text template or an emoticon, the message will automatically be sent to the recipients.

When you enter text by voice, you can select between text and audio for the message format. If the message format selection screen does not appear, open the Apps screen and tap  (**Settings**) → **App settings** → **Messages** → **Send as audio** to activate it.

Phone

Introduction

On your Gear, you can make or answer a call, or receive notifications for incoming calls, but you can only have phone conversations via your connected mobile device.

Receiving calls

Answering a call

When a call comes in, drag  outside the large circle. Alternatively, rotate the bezel clockwise.

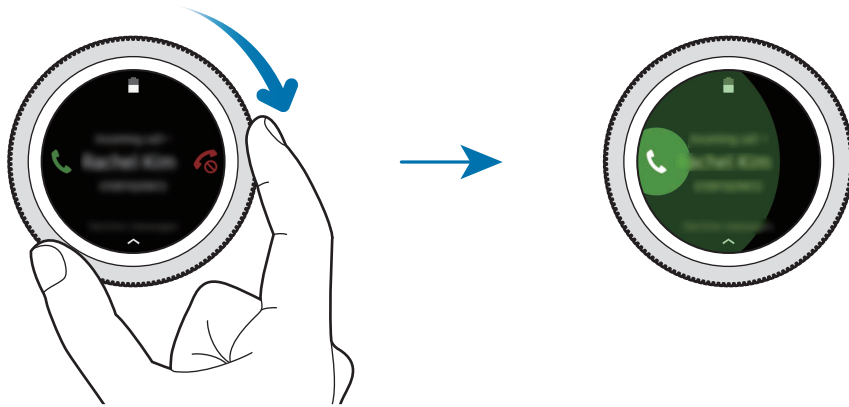

If the voice control feature is activated, say “Answer” to answer the call. To activate the voice control feature, open the Apps screen and tap  (Settings) → App settings → Call → Voice answer.

Call conversations are only possible on the connected mobile device.

Rejecting a call

Reject an incoming call and send a rejection message to the caller.

When a call comes in, drag  outside the large circle. Alternatively, rotate the bezel anticlockwise.

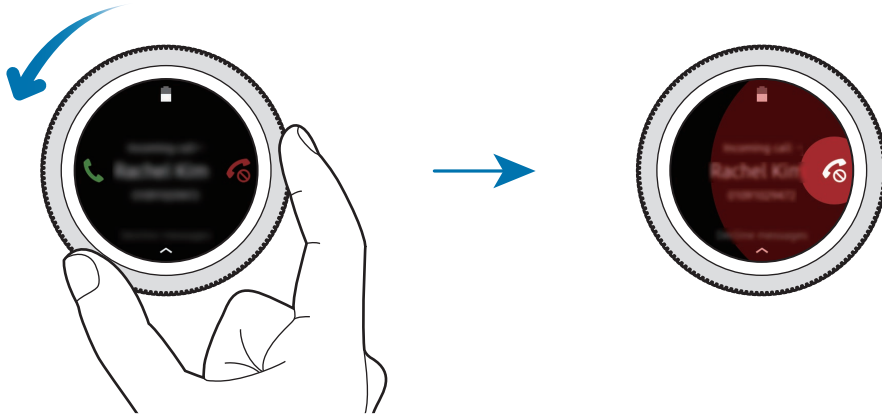

To send a message when rejecting an incoming call, swipe upwards from the bottom edge of the screen.

If the voice control feature is activated, say “Reject” to reject the call. To activate the voice control feature, open the Apps screen and tap  (Settings) → App settings → Call → Voice answer.

Missed calls





If a call is missed, a notification appears on the screen. On the Watch screen, swipe the screen to the right or rotate the bezel anticlockwise to view missed call notifications. Alternatively, tap  (Phone) on the Apps screen to view missed calls.

Making calls

Tap  (**Phone**) on the Apps screen.



Use one of the following methods:

- Tap , enter a number using the keypad, and then tap .
- Tap , search or select a contact, and then tap .
- Scroll through the log list, select a log entry, and then tap .

Contacts

View your mobile device's contacts list after connecting your Gear to your mobile device. You can make a call or send a message to a contact.

Tap  (**Contacts**) on the Apps screen.





The favourites list contacts on the mobile device will display on the top of the contacts list.



Use one of the following search methods:

- Tap  and enter the search criteria on the top of the contacts list.
- Scroll through the contacts list.
- Rotate the bezel. When you rotate the bezel quickly, the list scrolls by the alphabet of the first letter.

Once a contact is selected, take one of the following actions:

-  : Make a voice call.
-  : Compose a message.

Adding contacts

- 1 Tap  (**Contacts**) on the Apps screen.
- 2 Tap  on the top of the contacts list and enter the contact information.
- 3 Tap **SAVE**.

Selecting the frequently used contacts on the widget

After adding the **Contacts** widget, add the frequently used contacts to contact them easily via a text message or phone call. Tap **Add contacts**, add contact and then tap **DONE**. For more information about adding widgets, refer to [Adding widgets](#).



Up to four contacts can be added on the widget.

Adding medical information to my profile

Add medical information to my profile for the rescuer to quickly see it in an emergency situation.

On your mobile device, tap **Contacts**, select your profile and enter your medical information. To view your medical information on your Gear, on the Apps screen tap  (**Contacts**) → your profile and swipe upwards from the bottom edge of the screen.

In an emergency situation, press and hold the Gear's Home key (Power key) and tap **Emergency medical info**.



You may not use this feature depending on the mobile device that you connect to the Gear.

Samsung Pay

Register frequently used cards to Samsung Pay, a mobile payment service, to make payments quickly and securely. Samsung Pay supports near field communication (NFC) to allow payment through standard credit card readers.

You can view more information, such as cards that support this feature at www.samsung.com/samsungpay. Alternatively, launch the **Samsung Pay** app and tap **More** → **Help**.



- This app's availability and supported features may vary depending on the region or service provider.
- The procedures for the initial setup and card registration may vary depending on the region or service provider.

Making payments

- 1 On your mobile device, launch **Samsung Gear**.
- 2 Tap **OPEN SAMSUNG PAY** and follow the on-screen instruction to complete your card registration.
- 3 To make a payment on your Gear, press and hold the Back key.
- 4 Scroll through the cards list, select a card and tap **PAY**.

5 Place your Gear close to the card reader.

When the card reader recognises the card information, the payment will be processed.



- Payments may not be processed depending on your network connection.
- The verification method for payments may vary depending on the card readers.

Samsung Health

Introduction

Samsung Health records your 24-hour activities and encourages you to cultivate a healthy habit. When connecting your Gear to your mobile devices, you can save and manage the health-related data and also receive the useful information about your health every day.

When you exercise for more than 10 minutes while wearing the Gear, it will display an encouraging message. When the Gear recognises inactivity for more than one hour, it will notify you and show you some stretching motions to follow. When your Gear recognises you are driving, it may not display an encouraging message or stretches.

Tap  (**Samsung Health**) on the Apps screen.



- Samsung Health features are intended only for leisure, well-being, and fitness purposes. They are not intended for medical use. Before using these features, read the instructions carefully.
- Any information that is obtained from use of the Gear or the Fit Software or any application preloaded within may not be suitable, accurate, complete or reliable.

Wearing the Gear correctly

- When you activate the auto heart rate tracking feature, or when the Gear recognises your exercise, the Gear will automatically track your heart rate. When measuring your heart rate, wear the Gear snugly on your arm above your wrist as shown in the figure below.
- If you fasten the Gear too tightly, the skin irritation may occur and if you fasten it too loosely, friction may occur.
- Loosen the band after exercising.

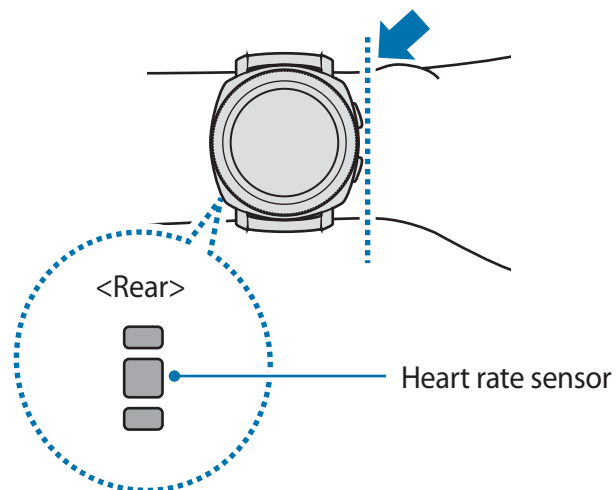



- The accuracy of the heart rate sensor may be diminished depending on measurement conditions and surroundings.
- Use the HR feature only for measuring your heart rate.
- Do not look directly at the heart rate sensor's lights. Doing so may impair your vision. Make sure children do not look directly at the lights.
- Cold ambient temperatures may affect your measurement; during winter or cold weather, keep yourself warm when checking your heart rate.
- Take heart rate measurements when you are seated and relaxed. Do not move your body while taking heart rate measurements. Doing so may cause your heart rate to be recorded inaccurately.
- If you receive a reading that is very different from your expected heart rate, rest for 30 minutes and then measure again.
- Smoking or consuming alcohol before taking measurements may cause your heart rate to be different from your normal heart rate.
- Do not talk, yawn, or breathe deeply while taking heart rate measurements. Doing so may cause your heart rate to be recorded inaccurately.
- Because the heart rate sensor uses light to approximate heart rate, its accuracy may vary due to physical factors that affect light absorption and reflection, such as blood circulation/blood pressure, skin condition and location and concentration of blood vessels. In addition, if your heart rate is extremely high or low, measurements may be inaccurate.
- Users with thin wrists may receive inaccurate heart rate measurements when the device is loose, causing the light to be reflected unevenly. If heart rate measurement is not working properly, adjust the position of the device's heart rate sensor to the right, left, up, or down on your wrist, or turn the device so the heart rate sensor sits firmly against the inside of your wrist.
- If the heart rate sensor is dirty, wipe the sensor and try again. Obstructions between the device's band and your wrist, such as body hair, dirt, or other objects may prevent the light from reflecting evenly. Please make sure you remove such obstructions before use.
- If your device becomes hot to the touch, remove it until it cools. Exposing skin to a hot surface of the device for a long time may cause skin burn.

Cal burned

Check your daily calories burned or how many calories you burned for this week, or the weekly average calories burned.

Tap  (**Samsung Health**) on the Apps screen and open the cal burned screen. Or, rotate the bezel clockwise on the Watch screen and select the **Calories** widget to launch it.

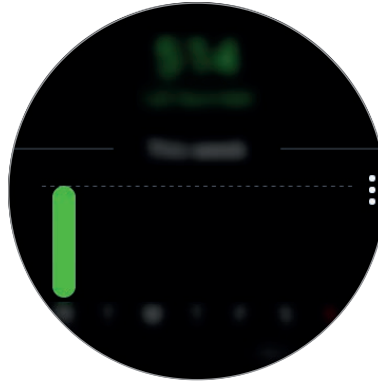

To view records by day, tap **View each date**.



The calories you burn includes your basal metabolism calculated based on the profile you registered. When you launch the **Samsung Health** app for the first time, the basal metabolism you expend until the time you launch the app will be displayed as the calories you burn.

Steps

The Gear counts the number of steps you have taken and measures the distance travelled.

Measuring your step count and distance you walk

Tap  (Samsung Health) on the Apps screen and rotate the bezel clockwise to open the steps tracker screen. Or, rotate the bezel clockwise on the Watch screen and select the **Steps** widget to launch it.

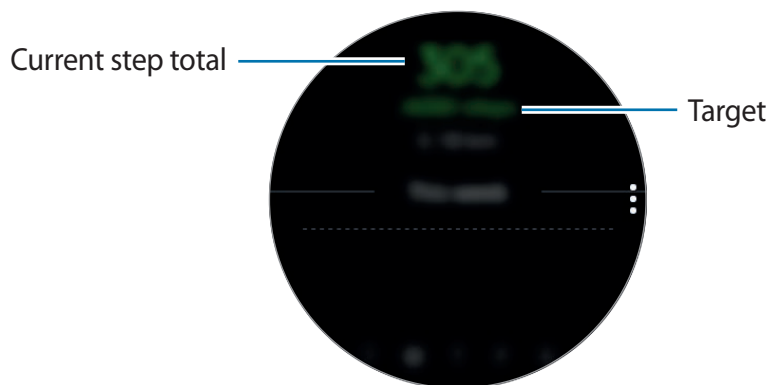

To view weekly records with a graph, swipe upwards or downwards on the screen. To view records by day, tap **View each date**.



- When you start to measure your step, the step tracker monitors your steps and displays your step account after a brief delay because your Gear accurately recognises your movement after you walk for a while. Also, for an accurate step count, you may experience a brief delay before the pop-up window indicates that a certain goal has been reached.
- If you use the steps tracker while travelling by car or train, vibration may affect your step count.

Setting the step target

- 1 Swipe upwards on the screen and tap **Settings**. Or, tap **⋮** → **Settings**.
- 2 Tap **Step target**.
- 3 Rotate the bezel to set the target and tap **DONE**.

Setting the alarm

- 1 To receive an alarm for reaching a target, swipe upwards on the screen and tap **Settings**. Or, tap **⋮** → **Settings**.
- 2 Tap **Notifications** to activate it.

Floors

Record and track how many floors you climb.

Measuring the floors you climb

Tap  (**Samsung Health**) on the Apps screen and rotate the bezel clockwise to open the floors tracker screen. Or, rotate the bezel clockwise on the Watch screen and select the **Floors** widget to launch it.

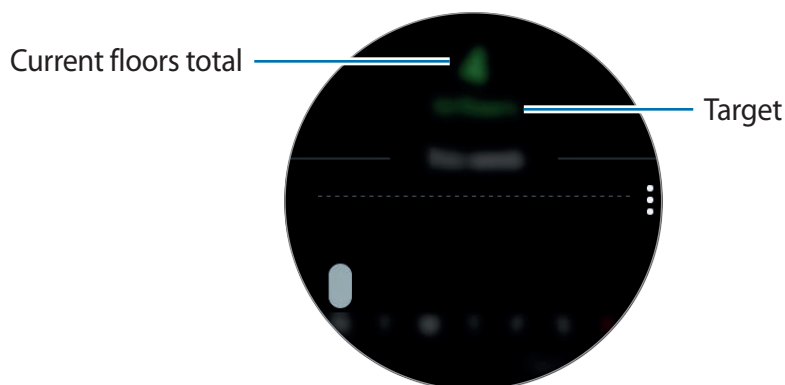

To view weekly records with a graph, swipe upwards or downwards on the screen. To view records by day, tap **View each date**.



- One floor is calculated as approximately 3 metres. The floors measured may not match the actual floors you climb.
- The floors measured may not be accurate depending on the environment, the user's movements, and the conditions of buildings.
- The floors measured may not be accurate if water (shower and water activity) or foreign materials enter the atmospheric pressure sensor. If there is any detergent, sweat, or raindrops on the Gear, rinse it with clean water and dry the atmospheric pressure sensor thoroughly before use.

Setting the target for climbing floors

- 1 Swipe upwards on the screen and tap **Settings**. Or, tap  → **Settings**.
- 2 Tap **Floor target**.
- 3 Rotate the bezel to set the target and tap **DONE**.

Setting the alarm

- 1 To receive an alarm for reaching a target, swipe upwards on the screen and tap **Settings**. Or, tap  → **Settings**.
- 2 Tap **Notifications** to activate it.

Exercise

Record your exercise information and calories burned using Samsung Health's exercise feature.



- Before using this feature, pregnant women, the elderly, and young children, users suffering from conditions, such as chronic heart disease or high blood pressure, are recommended to seek the advice of a licensed medical professional.
- If you feel dizzy, experience pain, or have difficulty breathing during exercise, stop using this feature and seek the advice of a licensed medical professional.
- If you have just purchased or have reset the Gear, create your profile.

Be aware of following conditions before exercising in cold weather conditions:

- Avoid using the device in cold weather. If possible, use the device indoors.
- If you use the device outside in cold weather, cover the Gear with your sleeves before using it.

Starting the exercise

- 1 Tap  (Samsung Health) on the Apps screen.
- 2 Rotate the bezel clockwise to open the exercise tracker screen.
- 3 Tap **WORK OUT** and select the type of exercise.



Rotate the bezel clockwise on the Watch screen and tap **WORK OUT** on the **Exercise** widget and select the type of exercise. If you exercise such as the walking, swimming, cycling or running, tap the corresponding icon on the **Multi-workouts** widget to start the exercise directly.

- 4 Tap **Target** to select a target type and set a target.

5 Tap  to start exercising.



- Set whether to use your location information when you use your Gear for the first time after purchasing or resetting it. Enabling the location information is set as the default.
- Your heart rate is measured in seconds when you start exercising. To measure your heart rate more accurately with the Gear, wear the Gear firmly around your lower arm just above your wrist.
- Do not move until your heart rate displays on the screen so it can be measured more accurately.
- When you select **Swimming**, water lock mode will be activated automatically.

You can view exercise information like speed, distance, heart rate and calories burned in real time when you rotate the bezel or swipe the screen to the left or right.

To listen to music, rotate the bezel anticlockwise.



6 You can view exercise information, such as calories burned and current speed, when you swipe the screen to the left or right.

When you are swimming, you can check additional exercise information, such as your previous stroke and pace.



- When you do intense exercise, stop exercising for a short time so your heart rate can be measured more accurately.
- When you select **Swimming**, water lock mode will be automatically activated and the touchscreen will be disabled. The screen will change automatically and you can check your exercise information.
- When you select **Swimming**, the recorded value may not be accurate in following cases:
 - If you stop swimming before reaching at the end of the lane
 - If you change your swimming stroke in midstream
 - If you do not move your arms or swim without moving your arms before reaching at the end of the lane
 - If you do not pause or restart the exercise by pressing the Back key, but finish the exercise by pressing the Back key and tapping **FINISH**

7 To pause or restart the exercise, press the Back key.

To finish exercising, tap **FINISH** → ✓ after pausing the exercise.

To finish swimming, tap and hold the Power key to deactivate water lock mode first and tap **FINISH** → ✓.

8 To view your exercise information, swipe upwards or downwards on the screen after finishing the exercise.



Music will continue to play even if you finish exercising. To stop playing music, stop music before finishing exercising or launch  (**Music Player**) to stop playing music.

Automatic exercise recognition

Once you have engaged in a middle or high-intensity activity for more than ten minutes while wearing the Gear, it automatically recognises that you are exercising and records exercise information such as the exercise type, duration and calories burned.

When you stop exercising for more than one minute, the Gear automatically recognises that you have stopped exercising and this feature is deactivated.



- Among the various exercise types, only walking, running, elliptical workouts, rowing, cycling and active workouts can be measured.
- The automatic exercise recognition feature measures the distance travelled and calories burnt using the acceleration sensor. The measurements may not be accurate depending on your walking and exercise routines.

Heart rate

Measure and record your heart rate.



- The Gear's heart rate tracker is intended for fitness and informational purposes only and is not intended for use in the diagnosis of disease or other conditions, or in the cure, mitigation, treatment, or prevention of disease.
- To measure your heart rate more accurately with the Gear, wear the Gear firmly around your lower arm just above the wrist. Refer to [Wearing the Gear correctly](#) for details.

Be aware of following conditions before measuring your heart rate:

- If you have just purchased or have reset the Gear, read the on-screen information about the app and create your profile.
- Rest for 5 minutes before taking measurements.
- If the measurement is very different from the expected heart rate, rest for 30 minutes and then measure it again.
- During winter or in cold weather, keep yourself warm when measuring your heart rate.
- Smoking or consuming alcohol before taking measurements may cause your heart rate to be different from your normal heart rate.

- Do not talk, yawn, or breathe deeply while taking heart rate measurements. Doing so may cause your heart rate to be recorded inaccurately.
- Heart rate measurements may vary depending on the measurement method and the environment they are taken in.
- If the heart rate sensor is not working, check the Gear's position on your wrist and make sure nothing is obstructing the sensor. If the heart rate sensor continues to have the same problem, visit a Samsung Service Centre.

Measuring your heart rate

- 1 Tap  (Samsung Health) on the Apps screen.
- 2 Rotate the bezel clockwise to open the heart rate tracker screen.
- 3 Tap **MEASURE** to begin measuring your heart rate.

After a moment, your current heart rate will be displayed on the screen.

The Gear displays information about your heart rate. The heart rate is measured based on your age and gender you entered in your profile and show whether your heart rate is within or out of the average resting heart rate range.



Rotate the bezel clockwise on the Watch screen and you can measure your heart rate directly on the **Heart rate** widget.

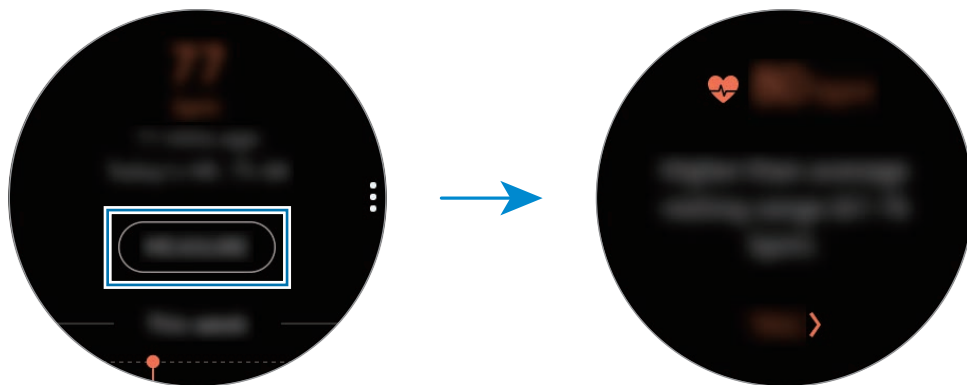

To view weekly records with a graph, swipe upwards or downwards on the screen. To view records by day, tap **View each date**.



Tracking your heart rate

The Gear can automatically measure and record your heart rate at regular intervals in your daily life when you are not using exercise trackers.

Tap  on the heart rate tracker screen, rotate the bezel to select **Auto HR settings**, and then select the option you want.

- **Always:** Your heart rate will be measured automatically in seconds regardless of your movement.
- **Frequent:** The Gear will attempt to measure your heart rate at an interval of 10 minutes when you do not move.
- **Never:** Your heart rate will not be measured automatically.

Water

Record and track how many glasses of water you drink.

Recording water consumption

- 1 Tap  (Samsung Health) on the Apps screen.
- 2 Rotate the bezel clockwise to open the water tracker screen.

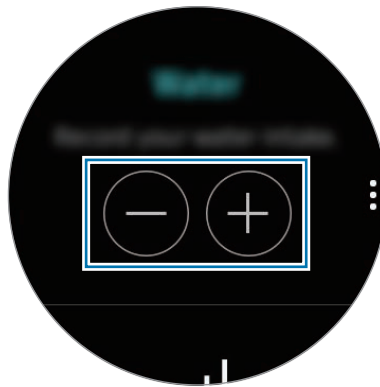

- 3 Tap  when you drink a glass of water.

If you accidentally added an incorrect value, you can fix it by tapping .

To view weekly records with a graph, swipe upwards or downwards on the screen. To view records by day, tap **View each date**.

Setting your target consumption

- 1 Swipe upwards on the screen and tap **Set target**. Or, tap  → **Set target**.
- 2 Tap **Set target** to activate the feature.
- 3 Tap **Daily target**.
- 4 Rotate the bezel to set the target and tap **DONE**.

Caffeine

Record and track how many cups of coffee you drink.

Recording your coffee consumption

- 1 Tap  (Samsung Health) on the Apps screen.
- 2 Rotate the bezel clockwise to open the caffeine tracker screen.

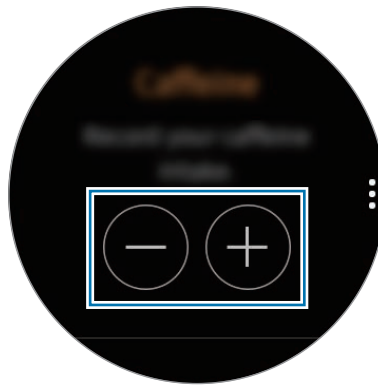

- 3 Tap  when you drink a cup of coffee.

If you accidentally added an incorrect value, you can fix it by tapping .

To view weekly records with a graph, swipe upwards or downwards on the screen. To view records by day, tap **View each date**.

Setting your caffeine consumption limit

- 1 Swipe upwards on the screen and tap **Set target**. Or, tap  → **Set target**.
- 2 Tap **Set target** to activate the feature.
- 3 Tap **Daily target**.
- 4 Rotate the bezel to set the target and tap **DONE**.

Together

Compare your weekly step count records with other Samsung Health users. You can set a goal, compete with your friends, and view the challenge status.



Activate the together feature in the Samsung Health app on your mobile device to check information on your Gear.

- 1 Tap  (Samsung Health) on the Apps screen.
- 2 Rotate the bezel clockwise to open the together screen.







Tap the screen to view detailed information such as your or your friends' challenges status or your or your friends' weekly step count ranking.

24-hour Log

View your daily activity based on your profile at a glance. You can also view your calories burned.

- 1 Tap  (Samsung Health) on the Apps screen.
- 2 Rotate the bezel clockwise to open the 24-hour log screen.
Rotate the bezel to view the time-based records.



- **Healthy** (): It indicates when you start to measure your exercise manually or begin middle or high-intensity exercise.
- **Light** (): This indicates the time spent doing light activity intermittently, but not hard exercise or inactivity.
- **Inactive** (): This indicates the cumulative time spent not walking or not working out for one hour or more.
- **Sleep** (): This indicates your sleep duration and efficiency.

Settings

You can set the various setting options related to the exercise.

Tap  (**Samsung Health**) and rotate the bezel clockwise and tap **Settings**.

- **Profile:** Enter your profile information, such as your gender, height, and weight.
- **Workout detection:** Set your Gear to recognise your workout automatically.
- **Inactive time alerts:** Alerts you of your inactive time when you are not moving for a period of time while wearing your Gear.
- **Sleep notifications:** Your Gear detects your sleeping status while wearing your Gear and provides details of your rest period.
- **Help:** View information about the **Samsung Health** app.

Additional information

- The purpose for such data collection is limited to providing the service that you have requested, including providing additional information to enhance your wellness, back up/sync data, data analysis and statistics or to develop and provide better services. (But if you sign in to your Samsung account from Samsung Health, your data may be saved on the server for data backup purposes.) Personal information may be stored until the completion of such purposes. To delete any data you have shared with social networks or transferred to storage devices, you must delete them separately.
- You assume full responsibility for the inappropriate use of data shared on social networks or transmitted to others. Use caution when sharing your personal data with others.
- If the Gear is connected to a mobile device, verify the communication protocol to confirm proper operation. If you use a wireless connection, such as Bluetooth, the Gear may be affected by electronic interference from other devices. Avoid using the Gear near other devices that transmit radio waves.
- The content used in the Samsung Health app may vary depending on the software version of the app. The services provided with the app are subject to change or the cancellation of support without prior notice.

- Available Samsung Health functions and services may vary depending on the local laws and regulations in your region.
- Some functions of Samsung Health may not be provided depending on your region.
- Samsung Health functions are intended for fitness and informational purposes only and is not intended for use in the diagnosis of disease or other conditions, or in the cure, mitigation, treatment, or prevention of disease.



- Measured distance may differ from the actual distance due to uneven strides, walking in place, and pacing around.
- Only records from the past thirty days are saved. You can view previous data on the mobile device where the Samsung Health app is installed.

Alti-Barometer

Measure the altitude and atmospheric pressure of your current location using the internal atmospheric pressure sensor.

Tap  (Alti-Barometer) on the Apps screen. To view the barometer, swipe to the left.

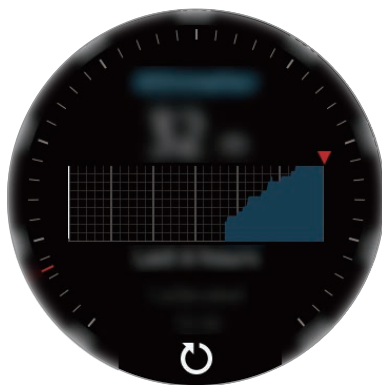

Altimeter

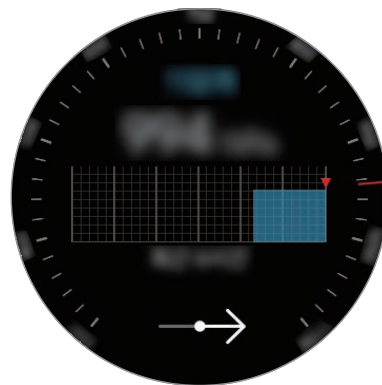

Barometer

Measuring your current altitude

Measure your current altitude and view a graph of changes over the last 6 hours.

Tap  (Alti-Barometer) on the Apps screen.



- If you have recently purchased or reset the Gear, tap **GO** to activate the Gear's GPS feature.
- After you calibrate the altimeter, the value for altimeter will become inaccurate after a period of time. To measure the accurate altitude, tap  frequently to calibrate the value for the altimeter.
- The altitude measured may not be accurate if water (shower and water activity) or foreign materials enter the atmospheric pressure sensor. If there is any detergent, sweat, or raindrops on the Gear, rinse it with clean water and dry the atmospheric pressure sensor thoroughly before use.

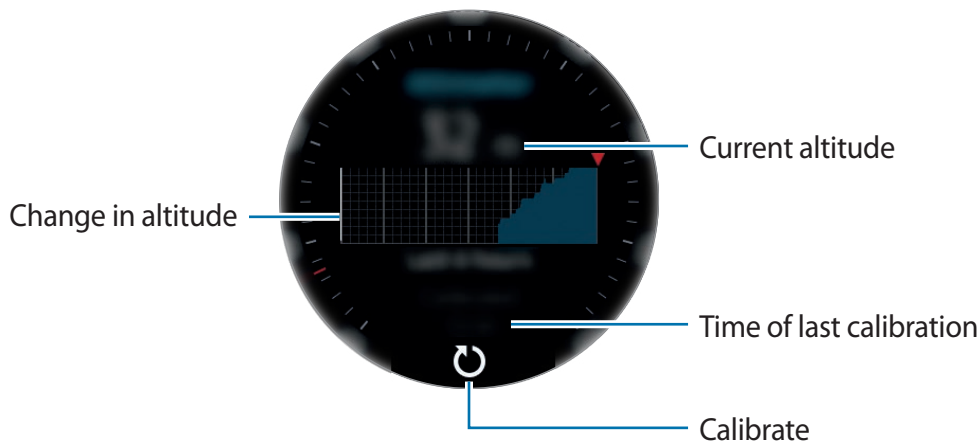

Manually calibrating the altitude

You can manually calibrate the measured altitude.

- 1 Swipe to the left to open the settings screen.
- 2 Tap **CHANGE >**.
- 3 Tap **Manual calibration** → **Manual calibration** to activate it.
- 4 Tap **Altitude** or **Sea level pressure** and set the reference value.
The altitude is calibrated based on the entered reference value.

Measuring your current atmospheric pressure

Measure your current atmospheric pressure and view a graph of changes over the last 6 hours. You can anticipate any changes to the weather using the pressure prediction gauge.

1 Tap  (Alti-Barometer) on the Apps screen.

2 Swipe to the left to open the barometer screen.



The atmospheric pressure measured may not be accurate if water (shower and water activity) or foreign materials enter the atmospheric pressure sensor. If there is any detergent, sweat, or raindrops on the Gear, rinse it with clean water and dry the atmospheric pressure sensor thoroughly before use.

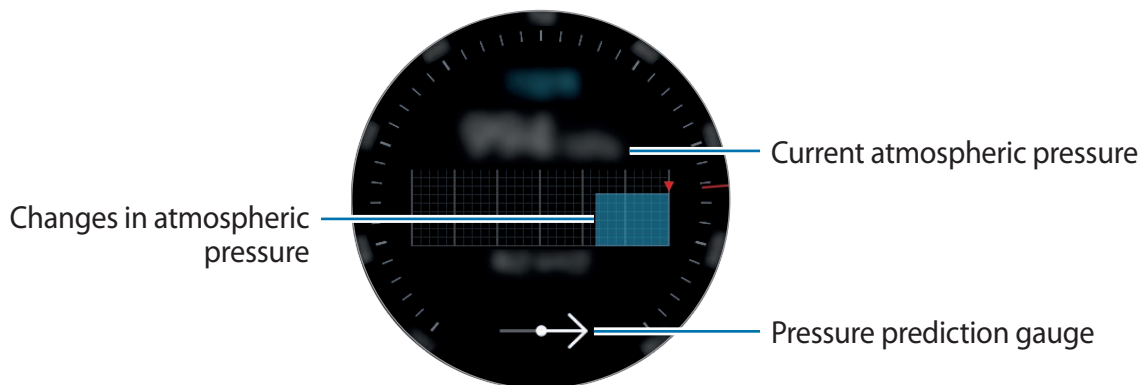

Configuring the alti-barometer

Scroll the screen to open the settings screen and tap **CHANGE** > to use the following options.

- **Auto refresh:** After adjusting the altimeter, it will automatically calibrate after a period of time.
- **Manual calibration:** Manually calibrate the altimeter based on the entered reference value for altimeter.
- **Pressure alerts:** Set to notify you of rapid changes of atmospheric pressure.
- **Altitude unit:** Change the height unit.
- **Pressure unit:** Change the pressure unit.
- **Help:** View information about using the alti-barometer.

Music Player

Introduction

Listen to music saved in the Gear and in the mobile device.

Playing music

Tap  (**Music Player**) on the Apps screen.

Swipe upwards from the bottom edge of the screen to open the library screen. On the library screen, you can view the currently playing song and playlist, and arrange music by tracks, albums, and artists.

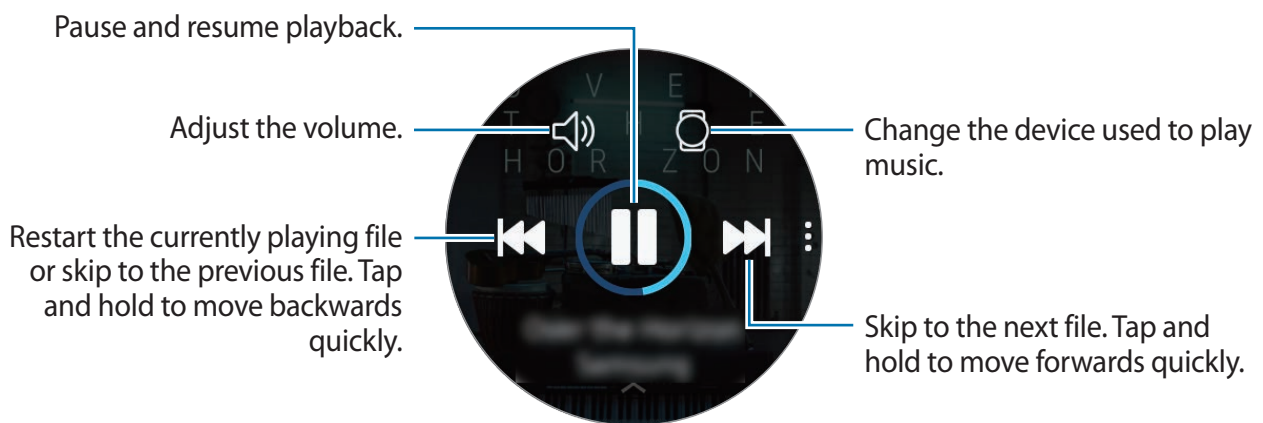

Importing music





Import music saved in your mobile device to your Gear.

- 1 Launch **Samsung Gear** on your mobile device.
- 2 Tap **SETTINGS** → **Transfer content to Gear**.
- 3 Tap **Select tracks**.
- 4 Select files and tap **DONE**.

To sync music in your mobile device with your Gear, tap the **Auto sync** switch under **MUSIC**. The music in your mobile device will be synced automatically with your Gear when it is charging and when it has more than 15 % of remaining battery power.





Playing music with the Gear

You can listen to music via a connected Bluetooth headset.

- 1 Tap  (**Music Player**).
- 2 Tap  to play the music saved in your Gear.
The icon will be changed to .
- 3 Tap .

Playing music from your mobile device

Play music saved on your mobile device and control it with your Gear.

- 1 Tap  (**Music Player**).
- 2 Tap  to play the music saved in your mobile device.
The icon will be changed to .
- 3 Tap .

Playing music without connecting to a mobile device



Listen to music or radio using the Gear by itself. You must download music or a radio streaming app on the Gear.

On the Apps screen, tap  (**Galaxy Apps**). Browse and download music or a radio streaming app in **Galaxy Apps** and launch the app.

Reminder

Add reminders for events such as buying tickets, going to the laundromat, or taking medicine, without using your calendar app. You can set alarms to receive reminders at specified times.

Creating a reminder

- 1 On the Apps screen, tap  (**Reminder**) → **Create reminder**. Or, rotate the bezel clockwise on the Watch screen and tap **Create reminder** on the **Reminder** widget. If you have a saved reminder, tap **Create** or  on the top of the list.
- 2 If your Gear supports voice input, speak a schedule to create a reminder. When you are finished, tap **DONE**.
Or, tap **WRITE >** to enter text and tap **Done**.
- 3 To set an alarm, tap **SET TIME >**, set the alarm time by rotating the bezel, and then tap **DONE**.
- 4 Tap **SAVE**.

Viewing the reminder alarm

When an alarm appears, check the reminder details.

You can also rotate the bezel anticlockwise on the Watch screen to open the notification panel and view reminders.



- Tap **EDIT TIME >** to set a reminder again or tap  and rotate the bezel to select **Delete** to remove it.
- You can view all reminders saved in your Gear and mobile device in the **Reminder** app.

Completing or deleting the reminder

When you have finished your task, you can set the reminder as completed or delete it.

On the reminder's details, tap  to complete it.

To delete it, tap , rotate the bezel, and tap **Delete**.

Calendar

View events scheduled on your mobile device and Gear.



All events scheduled on your Gear will be synced with the connected mobile device automatically to check them, and receive alarms from the mobile device.

- 1 Tap  (**Calendar**) on the Apps screen.
- 2 Tap anywhere on the monthly calendar.
The current day's events list will be shown.
- 3 To view upcoming events, rotate the bezel to clockwise.

S Voice

Introduction



Perform various tasks simply by speaking.



Make sure the Gear's microphone is not obstructed when you are speaking into it.

Setting a wake-up command

You can launch **S Voice** using your own wake-up command. You can only use this feature when your Gear's screen is turned on.

To set the wake-up command, tap  (**S Voice**) on the Apps screen and tap . Then rotate the bezel and tap **Set wake-up command**.

Using S Voice

- 1 Say the preset wake-up command. Alternatively, tap  (S Voice) on the Apps screen. When S Voice is launched, the Gear begins voice recognition.



This app may not be available depending on the region.

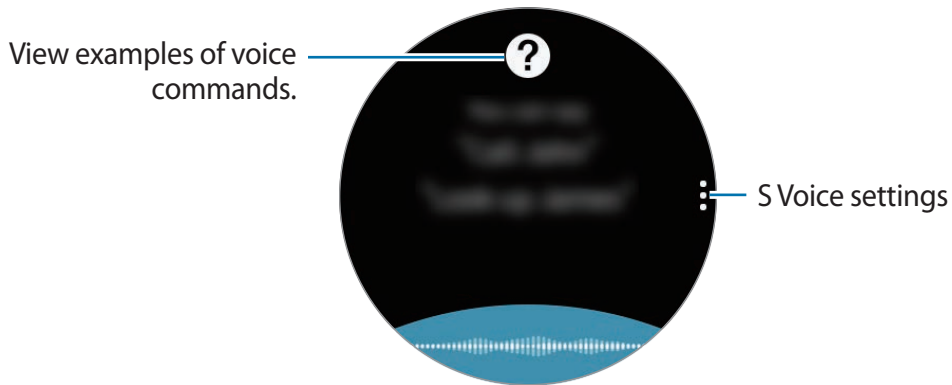



- 2 Say a voice command. If the Gear recognises the command, the Gear will perform the corresponding action. To repeat a voice command or say a different command, tap .

Tips for better voice recognition

- Speak clearly.
- Speak in quiet places.
- Do not use offensive or slang words.
- Avoid speaking in dialectal accents.

The Gear may not recognise your commands or may perform unwanted commands depending on your surroundings or how you speak.

Setting the language

On the Apps screen, tap  (**S Voice**) → , rotate the bezel, tap **Language**, and then select a language.



The selected language is applied to **S Voice** only, not to the language displayed on the Gear.

Weather

View weather information on the Gear for locations set on the mobile device when the devices are connected.

Tap  (**Weather**) on the Apps screen. Or, rotate the bezel clockwise on the Watch screen and select the **Weather** widget to launch it.

To view the current day's weather information, tap the screen and rotate the bezel.

To add other cities' weather information, rotate the bezel clockwise and tap **Add city**.

Alarm



Set alarms and manage them. When an alarm is set on your connected mobile device, your Gear will also alert you.

Setting alarms

- 1 Tap  (**Alarm**) on the Apps screen.
- 2 Tap **Add alarm**.
If you have a saved alarm, tap **Add** on the alarms list.
- 3 Set the alarm time by rotating the bezel and tap **NEXT**.

4 Select the days for the alarm to repeat and tap **SAVE**.

The saved alarm is added to the alarms list.

On the alarms list, tap  to activate the alarm or tap  to deactivate the alarm.

Stopping alarms

Drag  outside the large circle to stop an alarm. Alternatively, rotate the bezel clockwise.

If you want to use the snooze function, drag  outside the large circle. Alternatively, rotate the bezel anticlockwise.

Deleting alarms

In the alarms list, tap and hold an alarm, and then tap **DELETE**.

World clock

Creating world clocks

1 Tap  (**World clock**) on the Apps screen.

2 Tap **Add city**.

If you have a saved world clock, tap **Add** on the clocks list.

3 Rotate the bezel to select a time zone on the globe.

You can also tap **ALL CITIES >** and search for a city or select a city from the list.

4 Tap the city name representing the selected time zone.

Deleting world clocks

On the world clocks list, tap and hold a clock, and then tap **DELETE**.

Gallery



Importing and exporting images

Importing images from your mobile device

- 1 Launch **Samsung Gear** on your mobile device.
- 2 Tap **SETTINGS** → **Transfer content to Gear**.
- 3 Tap **Select photos**.
- 4 Select files and tap **DONE**.

To sync images on your mobile device with your Gear, tap the **Auto sync** switch under **PHOTO**, tap **Albums to sync**, select albums to import to your Gear, and then tap **DONE**. The selected albums will be automatically synced with your Gear when it is charging and when it has more than 15 % of remaining battery power.

Exporting images to your mobile device

- 1 Tap  (**Gallery**) on the Apps screen.
- 2 Tap an image.
- 3 Tap and hold the image to export.
- 4 Rotate the bezel and select any images to export.
- 5 Tap  → **Send to phone**.

You can view the exported images in Gallery app on your mobile device.

Viewing images

View and manage the images saved on your Gear.



- 1 Tap  (**Gallery**) on the Apps screen.
- 2 Rotate the bezel to scroll through the image list and select an image.

Zooming in or out

While viewing an image, double-tap the image to zoom in or out.



When an image is magnified, you can view the rest of the image by scrolling around the screen.

Deleting images

- 1 Tap  (**Gallery**) on the Apps screen.
- 2 Tap an image.
- 3 Tap and hold an image to delete.
- 4 Rotate the bezel and select any images you want to delete.
- 5 Tap **DELETE** → .





News Briefing

View the latest articles in various categories. You can catch up on news categories that interest you.

- 1 Tap  (**News Briefing**) on the Apps screen.
- 2 When you use the **News Briefing** app for the first time, read the legal notice and tap **AGREE**.
- 3 Tap **START** to select an article from a specific category and tap **OK**.
To edit categories, tap  → **Select topic**, and then tick categories.
- 4 Tap an article to read it.
To read the full article, tap  (**Show on phone**) and read it on your mobile device.

Find My Phone

If you misplace the mobile device, the Gear can help you find it.

- 1 Tap  (**Find My Phone**) on the Apps screen.
- 2 Tap .
The mobile device emits sounds and turns on the screen. Tap  and drag it to the left or right on the mobile device, or tap  on the Gear.

Viewing the location of your mobile device

Tap  → **Locate phone**.

The Gear will display your mobile device's location.

Email

View emails received on the mobile device and reply to them.

Reading emails

1 Tap  (**Email**) on the Apps screen.

2 Select an email to open the email screen.

To view an email on the mobile device, tap , rotate the bezel, and tap **Show on phone**.

To reply to an email, tap  (**Reply**) and enter your email. Or, you can also reply to an email by rotating the bezel clockwise.



You may not be able to reply to emails depending on the mobile device that you connect to the Gear.

PPT Controller

Introduction

You can control the PPT slides on your computer with your Gear after connecting the Gear to a computer.

Connecting your Gear to a computer via Bluetooth

1 Tap  (**PPT Controller**) on the Apps screen.

2 Tap **CONNECT** and allow your computer five minutes to find your Gear.

3 Search for or select your Gear from the Bluetooth list on your computer.



If your Gear does not appear on your computer, refer to the computer's user manual.

- 4 Follow the on-screen instructions to complete the connection and learn the basic features and controls when an on-screen tutorial appears on your Gear.



If your computer and Gear do not connect, cancel the Bluetooth request on both devices and try again. Alternatively, remove the Gear from your computer that previously appeared on the Bluetooth list, and try again. Refer to the computer's user manual for more information.



- 5 Tap **SLIDESHOW** to control the slides.

Tap  to move to the next slide or tap  to move to the previous slide. Alternatively, rotate the bezel clockwise or anticlockwise to move between slides.

Tap **TOUCHPAD**> and move your finger on the screen to control the cursor on your computer.

- 6 Tap **STOP** to stop controlling slides.

Connecting the Gear to a new computer

- 1 To connect the Gear to a new computer, tap  and rotate bezel to select **Connect new computer**.
- 2 Tap  to disconnect your Gear from the previous computer and tap **CONNECT** to connect it to a new computer.

Setting the alarm functions

Setting the wrap up alert

When you make a presentation using slides, set the finishing time on your Gear in advance to receive an alarm.

- 1 Tap  → **Wrap up alert**.
- 2 Tap **Wrap up alert** to activate it.
- 3 Tap **Set time** and rotate bezel to set the finish time and then tap **SET**.



Setting interval alerts

Set regular interval alerts on your Gear in advance to receive alerts while making a presentation.

- 1 Tap  and rotate bezel to select **Interval alerts**.
- 2 Tap **Interval alerts** to activate it.
- 3 Tap **Set time** and rotate bezel to set the interval and then tap **SET**.

Galaxy Apps

Download specialised apps and watch faces on your Gear, not through the connected mobile device.

On the Apps screen, tap  (**Galaxy Apps**). Scroll through the list and select an app to download or watch face or tap  to search for apps by keyword.

Tap  → **Show on phone** to launch **Galaxy Apps** on your mobile device. Then, browse and select an app or watch face to download.



Register your Samsung account on the connected mobile device first to use this app.

Settings

Introduction

Customise settings for functions and apps. You can make your Gear more personalised by configuring various setting options.

Tap  (**Settings**) on the Apps screen.

Watch faces and styles

Customise the watch face and the Apps screen.

On the Settings screen, tap **Watch faces and styles**.

- **Watch faces:** Select a watch type. You can also select items to display on the watch face and download more watch faces from **Galaxy Apps**.
- **Watch always on:** Set the Gear to display a watch when the screen is turned off.



The **Watch always on** feature only works while you are wearing the Gear.

- **Watch face order:** Select how to arrange the watch faces.
 - **Most recent first:** Set the recently used watch face to appear first.
 - **Custom:** Arrange the watch face to your preference.
- **Notification indicator:** Set the Gear to display a yellow dot on the Watch screen to alert you to notifications that you have not checked.
- **Status indicator:** Set the status indicators to display on the Watch screen.
- **Background style:** Change the wallpaper.
- **Font:** Change the font type and size.

Vibration

Change the settings for vibrations.

On the Settings screen, tap **Vibration**.

- **Vibration intensity:** Adjust the force of the vibration notification.
- **Long vibration:** Set the Gear to vibrate longer for incoming calls and notifications.
- **Ringtone vibration:** Select a vibration pattern for incoming calls.



This option is not displayed when you use the Gear without connecting to a mobile device.

- **Notification vibration:** Select a vibration pattern for notifications.

Device

Change the Gear's interaction settings.

On the Settings screen, tap **Device**.

- **Double press Home key:** Select an action to perform when you press the Gear's Home key twice.
- **Wake-up gesture:** Set the Gear to turn on the screen when you raise your wrist that is wearing the Gear.

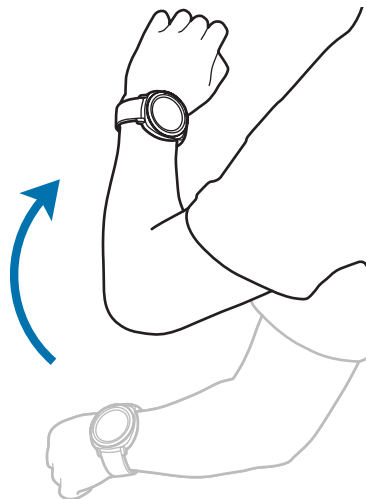

- **Bezel wake-up:** Set the Gear to turn on the screen when you rotate the bezel.
- **Water lock mode:** Activate water lock mode before entering the water. The touchscreen, the wake-up gesture feature, and watch always on feature will be deactivated.

- **Touch sensitivity:** Set the Gear to allow use of the touch screen with gloves on.
- **Do not disturb:** Set the Gear not to vibrate when receiving calls or notifications except for alarms.
- **Edit quick settings:** Set the quick control icons to display on the Gear's quick control panel.

Display

Change the display settings.

On the Settings screen, tap **Display**.

- **Brightness:** Adjust the brightness for the display.
- **Auto low brightness:** Set the Gear to automatically adjust the brightness depending on the ambient light conditions.
- **Screen timeout:** Set the length of time the Gear waits before turning off the display's backlight.

Connections

Bluetooth

Connect to a mobile device via Bluetooth. You can also connect a Bluetooth headset to your Gear and listen to music.



- Samsung is not responsible for the loss, interception, or misuse of data sent or received via Bluetooth.
- Always ensure that you share and receive data with devices that are trusted and properly secured. If there are obstacles between the devices, the operating distance may be reduced.
- Some devices, especially those that are not tested or approved by the Bluetooth SIG, may be incompatible with your device.
- Do not use the Bluetooth feature for illegal purposes (for example, pirating copies of files or illegally tapping communications for commercial purposes).
Samsung is not responsible for the repercussion of illegal use of the Bluetooth feature.

On the Settings screen, tap **Connections** → **Bluetooth**.

- **Bluetooth:** Turn the Bluetooth feature on or off.
- **BT headset:** Search for Bluetooth headsets and connect them to the Gear.

Wi-Fi

Activate the Wi-Fi feature to connect to a Wi-Fi network.

This feature is available when the Gear is not connected to the mobile device via Bluetooth.

1 On the Settings screen, tap **Connections** → **Wi-Fi**.

2 Tap **Wi-Fi** and select **Auto** or **Always on** to connect to a Wi-Fi network.

If you select **Auto**, the Wi-Fi network will be disconnected automatically when your Gear is connected to your mobile device via Bluetooth. If you select **Always off**, you can use your Gear after connecting it to your mobile device via Bluetooth instead of using a Wi-Fi network.



When you select the **Always on** option, the battery will drain more quickly than normal.

3 Tap **Wi-Fi networks** and select a network from the Wi-Fi networks list.

Networks that require a password appear with a lock icon.

4 Tap **CONNECT**.



- Once the Gear connects to a Wi-Fi network, the Gear will reconnect to that network each time it is available without requiring a password. To prevent the Gear connecting to the network automatically, select it from the list of networks and tap **FORGET**.
- If you cannot connect to a Wi-Fi network properly, restart your device's Wi-Fi feature or the wireless router.
- Turn off Wi-Fi to save the battery when not in use.

NFC

The Gear allows you to make payments and buy tickets for transportation or events after downloading the required apps.

On the Settings screen, tap **Connections** → **NFC**.



The Gear contains a built-in NFC antenna. Handle the Gear carefully to avoid damaging the NFC antenna.

- **NFC:** Activate the NFC feature to link your Gear to your credit or debit card.
- **Tap and pay:** Set the default payment app for mobile payments.



This feature may not be available depending on the region or service provider.

Making payments with the NFC feature

Before you can use the NFC feature to make payments, you must register for the mobile payment service. To register or get more information about the service, contact your service provider.

- 1 On the Settings screen, tap **Connections** → **NFC** → **NFC** to activate it.
- 2 Touch the NFC antenna area at the top of the Gear's touchscreen to the NFC card reader.

To set the default payment app, open the Settings screen and tap **Connections** → **NFC** → **Tap and pay**, and then select an app.



The payment services list may not include all available payment apps.

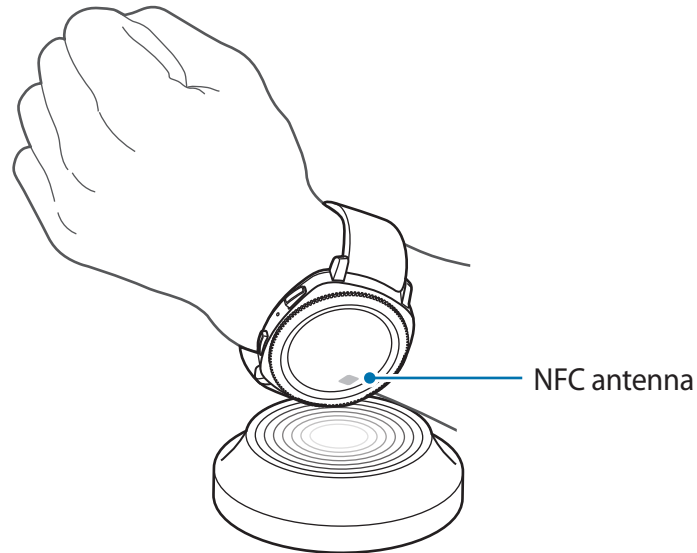

Alerts

Set the Gear to vibrate when it is disconnected from your mobile device.

On the Settings screen, tap **Connections** → **Alerts** to activate it.



This feature is not displayed when you use the Gear without connecting to a mobile device.

Flight mode

This disables all wireless functions on your device. You can use only non-network services.

On the Settings screen, tap **Connections** → **Flight mode**.



Make sure the device is turned off during takeoff and landing. After takeoff, you can use the device in flight mode if allowed by aircraft personnel.

Location

Set the Gear to allow apps to use your current location information.

On the Settings screen, tap **Connections** → **Location**.

Tap **Location** to activate it and select a method to collect your location data.

App settings

App order

Select how to arrange the apps on the Apps screen.

On the Settings screen, tap **App settings** → **App order**.

- **Most recent first:** Set the recently used apps to appear first.
- **Custom:** Arrange the apps to your preference.

Auto open apps

Set an app to launch by rotating the bezel without tapping the app. When the bezel indicator icon hovers over an app, the app will be launched automatically.

On the Settings screen, tap **App settings** → **Auto open apps**.

Call

Change the call feature settings.

On the Settings screen, tap **App settings** → **Call**.

- **Voice answer:** Set the Gear to answer or reject calls using voice commands.



This feature is not displayed when you use the Gear without connecting to a mobile device.

Messages

Change the message feature settings.

On the Settings screen, tap **App settings** → **Messages**.

- **Send as audio:** Set the Gear to send a voice message as an audio file.



This feature is not displayed when you use the Gear without connecting to a mobile device.

Security

Gear lock

Change the settings for securing the Gear. When you use this feature, the Gear may be locked automatically when it does not move for a period of time.

On the Settings screen, tap **Security** → **Gear lock**.

- **Type:** Select the Gear lock method.
- **Help:** View information about locking your Gear.

Security update service

You can update the security policy manually or automatically.

On the Settings screen, tap **Security** → **Security update service**.

- **Check for updates:** Update the Gear's security policy manually.
- **Auto update:** Update the Gear's security policy automatically.
- **Download updates:** Set the Gear to update the security policy automatically when connected to Wi-Fi or a mobile network.



When you use the Gear without connecting to a mobile device, the security policy can be updated only when the Gear is connected to Wi-Fi.

Account and backup

Login with your Samsung account and backup the data in your Gear on the Samsung Cloud or restore the Gear's data saved on your Samsung account on your Gear.

On the Settings screen, tap **Account and backup**.

- **Samsung account:** Enter your Samsung account and log in.
- **Backup and restore:** Backup the data saved in your Gear on the Samsung Cloud or restore data saved on the Samsung Cloud on your Gear.



This feature is displayed only when you use the Gear without connecting to a mobile device.

General management

Input

Change the text input settings.

On the Settings screen, tap **General management** → **Input**.

- **Default keyboard:** Check the default keyboard for entering the characters.
- **Keyboard settings:** Configure the Samsung keyboard's settings.

Text-to-speech

Change the settings for text-to-speech features, such as languages, speed, and more.

On the Settings screen, tap **General management** → **Text-to-speech**.

- **Language:** Select a language to use.
- **Speech rate:** Set the reading speed.
- **Read out notifications:** Set the Gear to read out the received notification on your Gear.
- **Check for updates:** Update the supported languages.

Date and time

You can set the date and time manually.

On the Settings screen, tap **General management** → **Date and time**.

- **Set date:** Set the date manually.
- **Set time:** Set the time manually.
- **Select time zone:** Select the time zone manually.
- **Use 24-hour format:** Display time in 24-hour format.



The **Date and time** options are available only when you use the Gear without connecting to a mobile device.

Language

Select a language to use on your Gear.

On the Settings screen, tap **General management** → **Language**.



The **Language** option is displayed only when you use the Gear without connecting to a mobile device.

Reset Gear

Delete all data on your Gear.

On the Settings screen, tap **General management** → **Reset Gear**.

Update Gear software

Update Gear to the latest software.

On the Settings screen, tap **General management** → **Update Gear software**.



The **Update Gear software** option is displayed only when you use the Gear without connecting to a mobile device.

Battery management

Select the Gear's battery mode. You can reduce the battery consumption with some battery modes.

On the Settings screen, tap **Battery management**.

- **Default:** Select when using your Gear normally. You can use all features of the Gear.
- **Power saving:** Select when activating power saving mode. Displays colours on the screen as grey tones and some feature are restricted to reduce the battery consumption. Refer to [Power saving mode](#) for more information.
- **Watch only:** Only the watch displays on the screen and all other features will be deactivated to reduce the battery consumption. Press the Home button to view the watch. Press and hold the Home key to deactivate Watch only mode.

About Gear

View the Gear's information.

On the Settings screen, tap **About Gear**.

- **Device information:** Access information about the Gear.
- **Model number:** Check your Gear's model number.
- **Storage:** Check the available storage space.
- **Software information:** Check your Gear's software version and security status.
- **Battery information:** Check the Gear's battery voltage and capacity.
- **Open source licences:** View the guide for checking the Gear's open source licence.
- **Report diagnostic and usage info:** Set the Gear to automatically send the device's diagnostic and usage information to Samsung.
- **Debugging:** Activate or deactivate debugging mode when developing apps for the Gear.

Connect to new phone

Connect your Gear to a new mobile device. The Gear can connect to another mobile device after performing a light reset to delete data except media files and personal data.

On the Settings screen, tap **Connect to new phone**.



This feature is available only when the Gear is connected to a mobile device.

Connect to phone

Connect to a mobile device while you are using the Gear by itself. You can select whether to restore the Gear's data that is saved on the mobile device.

On the Settings screen, tap **Connect to phone** → **NEXT**.

- **✓**: Connect your Gear to a mobile device and sync your health information, setting values, and contacts information saved in the Gear.
- **✗**: Connect your Gear to a mobile device after resetting all the data saved in the Gear.



This feature is displayed only when you use the Gear without connecting to a mobile device.

Samsung Gear app

Introduction

To connect your Gear to a mobile device, you must install the Samsung Gear app on your mobile device. You can check the Gear's status and download recommended watch faces and apps. You can also customise your Gear's various settings, such as your notification settings.

Launch **Samsung Gear** on your mobile device.



Some features may not be available depending on the type of connected mobile device.

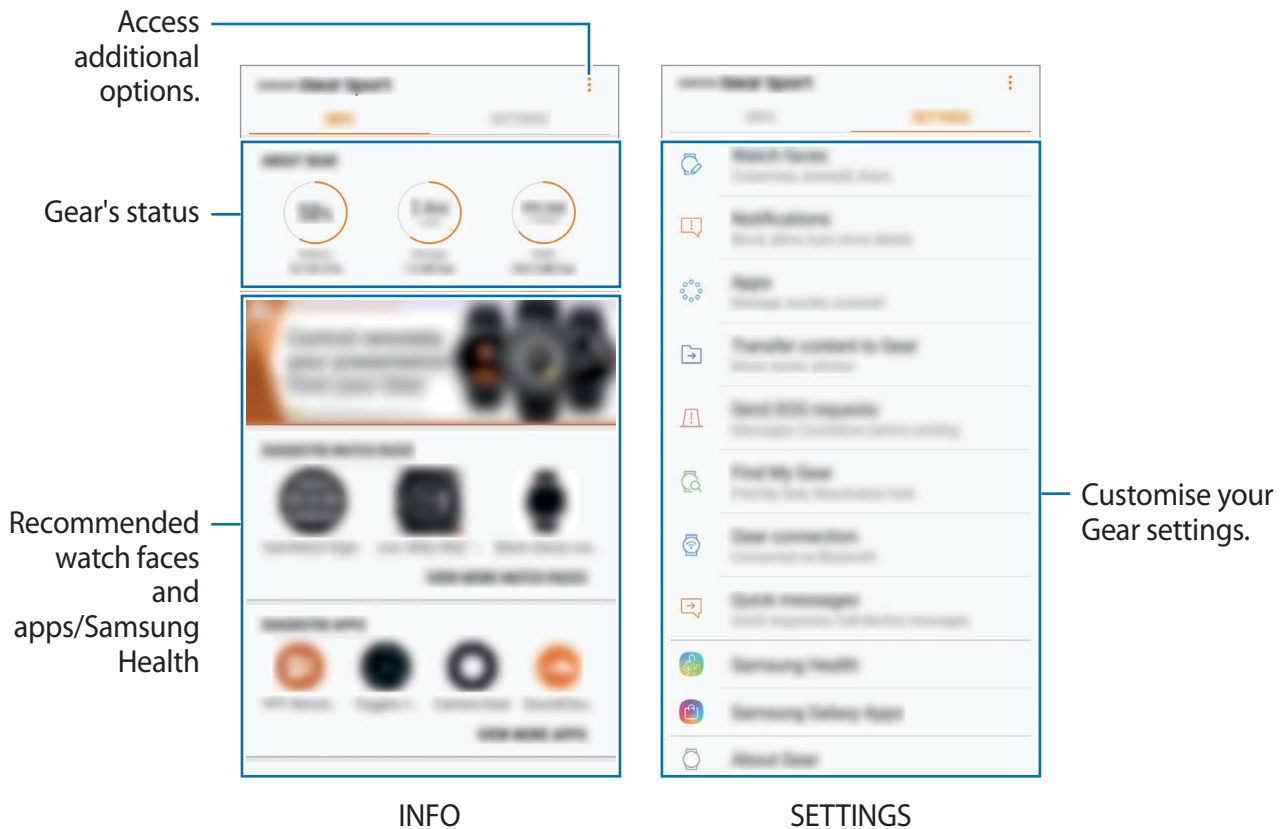

Tap  to use the following options:

- **Disconnect:** Disconnect your Gear from the currently connected mobile device.
- **Connect new Gear:** Disconnect your Gear from the currently connected mobile device and connect a new Gear. Tap **SCAN** to find a new Gear. To reconnect to a previously connected Gear, select one from the **PAIRED DEVICES** list.
- **User manual:** View the user manual to learn how to use your Gear.
- **Contact us: Samsung Members** offers support services to customers, such as device problem diagnosis, and lets users submit questions and error reports. You can also share information with others in the Galaxy users' community or view the latest Galaxy news and tips. **Samsung Members** can help you solve any problems you might encounter while using your device.



This feature may not be available depending on the region, service provider or model that does not support the **Samsung Members** app.

INFO

View your Gear's status, Samsung Health data, and download recommended watch faces and apps.

Launch **Samsung Gear** on your mobile device and tap **INFO**.

ABOUT GEAR

Provide a status overview of your Gear's battery, storage, and RAM.

Select an item to view its details.

SUGGESTED WATCH FACES

You can download recommended watch faces from **Galaxy Apps**.

Select a suggested watch face to download it. To view more watch faces, tap **VIEW MORE WATCH FACES**.

SUGGESTED APPS

You can download recommended apps from **Galaxy Apps**.

Select a suggested app to download it. To view more apps, tap **VIEW MORE APPS**.

HEALTH

View Samsung Health's saved data such as the step counts or your heart rate.

Tap **OPEN SAMSUNG HEALTH**.

SETTINGS

Watch faces

You can change the type of watch to be displayed on the Watch screen.

Launch **Samsung Gear** on your mobile device, tap **SETTINGS** → **Watch faces**, and select a desired watch type. The watch face you selected will be applied on the Watch screen.

Tap **CUSTOMISE** to change the background and set items to display on the watch face.

Notifications

Change settings for the notification feature. Stay up to date with a variety of events, such as new messages received on the mobile device.

Launch **Samsung Gear** on your mobile device, tap **SETTINGS** → **Notifications**, tap the switch to activate it, and then activate items.

- **Manage notifications:** Select apps on the mobile device to send notifications to the Gear.
- **Show only while wearing Gear:** Set the Gear to show notifications only while you are wearing it.
- **Show while using phone:** Set the Gear to show notifications while using your mobile device.
- **Turn on screen:** Set the Gear to turn on the screen when the notification is received.

- **Auto show details:** Set the Gear to show details for notifications when they are received.
- **Notification indicator:** Set the Gear to display a yellow dot on the Watch screen to alert you to notifications that you have not checked.
- **Smart relay:** Set the mobile device to display notification information that is displayed on the Gear when you pick up the mobile device.



- The smart relay feature is only available when the Gear's screen is turned on.
- Some mobile devices do not support the smart relay feature.
- The mobile device must be unlocked first to view details when the screen is locked.

Apps

Customise the Gear's Apps screen. You can select and rearrange apps.

Launch **Samsung Gear** on your mobile device and tap **SETTINGS** → **Apps**.

Uninstalling apps

Tap  → **Uninstall** and tap  next to the apps you want to remove from the Gear.

Reordering apps

1 Tap  → **Reorder** and tap **Custom**.

2 Tap  next to an app and drag it up or down to another position.

Transfer content to Gear

Transfer saved audio or image files from your mobile device to your Gear manually or automatically.

Launch **Samsung Gear** on your mobile device and tap **SETTINGS** → **Transfer content to Gear**.

- **Select tracks:** Select audio files and manually send them from the mobile device to the Gear.
- **Auto sync:** Set the device to sync recently added audio files with the Gear while it is charging and when it has more than 15 % of remaining battery power.



When the Gear does not have enough available memory, it deletes files that you have not set as your favourites in order from the music files you first added.

- **Playlists to sync:** Select a playlist to sync with the Gear.



Playlists to sync is available only when the Samsung Music app is installed on your mobile device and it is activated when you turn on the **Auto sync** feature.

- **Select photos:** Select images and manually send them from the mobile device to the Gear.
- **Auto sync:** Set the device to sync images with the Gear while the Gear is charging and when it has more than 15 % of remaining battery power.
- **Albums to sync:** Select an image album to sync with the Gear.

Send SOS requests

Set the device to send help messages by pressing the Gear's Home key three times.

Launch **Samsung Gear** on your mobile device, tap **SETTINGS** → **Send SOS requests**, and tap the switch to activate it. Refer to [SOS messages](#) for more information.

Find My Gear

Remotely control your Gear when it is lost or misplaced.

Launch **Samsung Gear** on your mobile device and tap **SETTINGS** → **Find My Gear**.



Register your Samsung account on the connected mobile device first to use this feature.

- **Reactivation lock:** Set the Gear to require your Samsung account information after the device has been reset. This prevents others from reactivating your device if it is lost or stolen.
- **Control remotely:**
 - **Locate Gear:** View the location of your Gear.
 - **Lock Gear:** Remotely lock the Gear to prevent unauthorised access. This feature can be used when your mobile device is connected to your Gear via Bluetooth or a remote connection. When your Gear is locked, connect your mobile device to the Gear via Bluetooth. The lock will be deactivated automatically.
 - **Reset Gear:** Remotely delete all personal information stored in the Gear. After the Gear is reset, you cannot restore the information or use the Find My Gear feature.

Gear connection

Customise your Gear's wireless connection settings.

Launch **Samsung Gear** on your mobile device, tap **SETTINGS** → **Gear connection**, and tap the switch to activate it.

- **Remote connection:** Set the Gear to remotely connect to the mobile device when a Bluetooth connection between the devices is not available.



Register your Samsung account on the connected mobile device first to use this feature.

- **Sync Wi-Fi profiles:** Set the device to sync the list of saved Wi-Fi networks with your Gear.

Quick messages

Edit or add templates used for replying to messages or rejecting incoming calls.

- 1 Launch **Samsung Gear** on your mobile device and tap **SETTINGS** → **Quick messages**.
- 2 Tap **Quick responses** or **Call-decline messages**.
- 3 Select a template to edit.
To create additional templates, tap .
- 4 Edit the template and tap **SAVE**.

Samsung Health

View the data saved in the Samsung Health app.

Launch **Samsung Gear** on your mobile device and tap **SETTINGS** → **Samsung Health**.

Samsung Galaxy Apps

Purchase and download apps or watch faces that are specialised for the Gear from the **Galaxy Apps** app.

Launch **Samsung Gear** on your mobile device and tap **SETTINGS** → **Samsung Galaxy Apps**.

Browse by category and select an app and watch face to download.

About Gear

View your Gear's status, back up or restore data, or update the Gear's software.

Launch **Samsung Gear** on your mobile device and tap **SETTINGS** → **About Gear**.

- **Battery:** Check the remaining battery power and time to use the Gear.



The usage time left shows the time remaining before the battery power runs out. Usage time left may vary depending on your device settings and operating conditions.

- **Storage:** Check the status of the used and available memory. To delete unnecessary files, tap **CLEAN NOW**.



The actual available capacity of the internal memory is less than the specified capacity because the operating system and default apps occupy part of the memory. The available capacity may change when you update the device.

- **RAM:** Check the status of the used and available RAM. To speed up your Gear by reducing the amount of RAM you are using, tick apps from the apps list, and tap **CLEAN NOW**.
- **Update Gear software:** Update the Gear to the latest software.
- **Back up and restore:** Back up the Gear's data on the Samsung Gear app or restore backup data. Refer to [Backing up and restoring data](#) for more information.
- **Legal information:** View the legal information for the Gear.
- **Unknown sources:** Set the Gear to allow the installation of apps from unknown sources.
- **Marketing information:** Set whether to receive Samsung marketing information, such as special offers, membership benefits, and newsletters.
- **Samsung account:** View the Samsung account information.
- **Device name:** Change the Gear's name.

Updating software via the Samsung Gear app

The Gear can be directly updated to the latest software by the firmware over-the-air (FOTA) service.

- 1 Launch **Samsung Gear** on your mobile device.
- 2 Tap **SETTINGS** → **About Gear** → **Update Gear software** → **Download updates manually**.
- 3 Tap **DOWNLOAD** and install the latest software version on your mobile device.
- 4 Read the on-screen information and tap **INSTALL NOW**.

The Gear will copy the updated software from your mobile device and restart.



To automatically check for available updates and download them, tap **Download updates automatically** to activate it. Updates will be downloaded only when the device is connected to a Wi-Fi network.

Backing up and restoring data

Keep the Gear's settings data and other app settings and restore them later.

To back up data, launch **Samsung Gear** on your mobile device and tap **SETTINGS** → **About Gear** → **Back up and restore** → **Back up settings** → **BACK UP NOW**. The data will be saved in Samsung Cloud.



- Music and images saved on the Gear will not be backed up.
- Samsung Health app data will be automatically saved on the connected mobile device's Samsung Health app.

To restore, launch **Samsung Gear** on your mobile device and tap **SETTINGS** → **About Gear** → **Back up and restore** → **Restore** → **RESTORE NOW**. The latest backup data will be restored.

About Samsung Gear app

View version information of the Samsung Gear app.

Launch **Samsung Gear** on your mobile device and tap **SETTINGS** → **About Samsung Gear app**.

Appendix

Troubleshooting

Before contacting a Samsung Service Centre, please attempt the following solutions. Some situations may not apply to your Gear.

Your Gear does not turn on

When the battery is completely discharged, your Gear will not turn on. Charge the battery completely before turning on the Gear.

The touchscreen responds slowly or improperly

- If you attach a screen protector or optional accessories to the touchscreen, the touchscreen may not function properly.
- If you are wearing gloves, if your hands are not clean while touching the touchscreen, or if you tap the screen with sharp objects or your fingertips, the touchscreen may malfunction.
- The touchscreen may malfunction in humid conditions or when exposed to water.
- Restart your Gear to clear any temporary software bugs.
- Ensure that your Gear software is updated to the latest version.
- If the touchscreen is scratched or damaged, visit a Samsung Service Centre.

Your Gear freezes or has fatal errors

Try the following solutions. If the problem is still not resolved, contact a Samsung Service Centre.

Restarting the device

If your Gear freezes or hangs, you may need to close apps or turn off the device and turn it on again.

Forcing restart

If your Gear is frozen and unresponsive, press and hold the Home key (Power key) for more than 7 seconds to restart it.

Resetting the device

If the methods above do not solve your problem, perform a factory data reset.

On the Apps screen, tap  (**Settings**) → **General management** → **Reset Gear**. Before performing the factory data reset, remember to make backup copies of all important data stored in the Gear.

Another Bluetooth device cannot locate your Gear

- Ensure that the Bluetooth wireless feature is activated on your Gear.
- Reset your Gear and try again.
- Ensure that your Gear and the other Bluetooth device are within the Bluetooth connection range (10 m). The distance may vary depending on the environment the devices are used in.

If the tips above do not solve the problem, contact a Samsung Service Centre.

A Bluetooth connection is not established or your Gear and the mobile device are disconnected

- Ensure that the Bluetooth feature on both devices is activated.
- Ensure there are no obstacles, such as walls or electrical equipment, between the devices.
- Ensure that the latest version of the Samsung Gear app is installed on the mobile device.
- Ensure that your Gear and the other Bluetooth device are within the Bluetooth connection range (10 m). The distance may vary depending on the environment the devices are used in.
- Restart both devices and launch the Samsung Gear app on the mobile device again.

Calls are not connected

- Ensure that your Gear is connected to a mobile device via Bluetooth. If your Gear is connected to your mobile device remotely, you cannot receive incoming calls.
- Ensure that you have not set call barring for the incoming phone number on the mobile device.
- Check whether do not disturb mode is activated. If it is activated, the touchscreen does not turn on during incoming calls. Rotate the bezel or press the Home key or Back key to turn on the screen and check the incoming call.

The battery icon is empty

Your battery is low. Charge the battery.

The battery does not charge properly (For Samsung-approved chargers)

- Ensure that you connect the Gear to the wireless charging dock and connect the dock to the charger properly.
- Visit a Samsung Service Centre and have the battery replaced.

The battery depletes faster than when first purchased

- When you expose the Gear or the battery to very cold or very hot temperatures, the useful charge may be reduced.
- Battery consumption increases when you use some apps.
- The battery is consumable and the useful charge will get shorter over time.

Your Gear is hot to the touch

When you use apps that require more power or use apps on your Gear for an extended period of time, your Gear may feel hot to the touch. This is normal and should not affect your Gear's lifespan or performance.

If the device overheats or feels hot for a prolonged period, do not use it for a while. If the device continues to overheat, contact a Samsung Service Centre.

The information of Alti-barometer is wrong

- After you calibrate the altimeter, the value for altimeter will become inaccurate after a period of time. To measure the accurate altitude, tap  frequently to calibrate the value for the altimeter.
- The altitude measured may not be accurate if water (shower and water activity) or foreign materials enter the atmospheric pressure sensor. If there is any detergent, sweat, or raindrops on the Gear, rinse it with clean water and dry the atmospheric pressure sensor thoroughly before use.

Your Gear cannot find your current location

The Gear uses your mobile device's location information. GPS signals may be obstructed in some locations, such as indoors. Set the mobile device to use Wi-Fi network to find your current location.

Data stored in the Gear has been lost

Always make backup copies of all important data stored in the Gear through the Samsung Gear app. Otherwise, you cannot restore data if it is corrupted or lost. Samsung is not responsible for the loss of data stored in the Gear.

A small gap appears around the outside of the Gear case

- This gap is a necessary manufacturing feature and some minor rocking or vibration of parts may occur.
- Over time, friction between parts may cause this gap to expand slightly.

Removing the battery

- **To remove the battery, contact an authorised service centre. To obtain battery removal instructions, please visit www.samsung.com/global/ecodesign_energy.**
- For your safety, you **must not attempt to remove** the battery. If the battery is not properly removed, it may lead to damage to the battery and device, cause personal injury, and/or result in the device being unsafe.
- Samsung does not accept liability for any damage or loss (whether in contract or tort, including negligence) which may arise from failure to precisely follow these warnings and instructions, other than death or personal injury caused by Samsung's negligence.

Copyright

Copyright © 2017 Samsung Electronics

This manual is protected under international copyright laws.

No part of this manual may be reproduced, distributed, translated, or transmitted in any form or by any means, electronic or mechanical, including photocopying, recording, or storing in any information storage and retrieval system, without the prior written permission of Samsung Electronics.

Trademarks

- SAMSUNG and the SAMSUNG logo are registered trademarks of Samsung Electronics.
- Bluetooth® is a registered trademark of Bluetooth SIG, Inc. worldwide.
- Wi-Fi®, Wi-Fi Protected Setup™, Wi-Fi Direct™, Wi-Fi CERTIFIED™, and the Wi-Fi logo are registered trademarks of the Wi-Fi Alliance.
- All other trademarks and copyrights are the property of their respective owners.