



Owner's Manual

LG Minibeam UST

DLP Projector

Please read the safety information carefully before using this product.

PH450UG

www.lg.com

P/NO : SAC37034602 (1609-REV00)

LICENSES

Supported licenses may differ by model. For more information about licenses, visit www.lg.com.



Manufactured under license from Dolby Laboratories. Dolby and the double-D symbol are trademarks of Dolby Laboratories.



This DivX Certified® device has passed rigorous testing to ensure it plays DivX® video. To play purchased DivX movies, first register your device at vod.divx.com. Find your registration code in the DivX VOD section of your device setup menu.

DivX Certified® to play DivX® video up to HD 1080p, including premium content.

DivX®, DivX Certified® and associated logos are trademarks of DivX, LLC and are used under license.

Covered by DivX Patents 7,295,673; 7,515,710; RE45,052; and others available at [www.divx.com/patents]



The terms HDMI and HDMI High-Definition Multimedia Interface, and the HDMI logo are trademarks or registered trademarks of HDMI Licensing LLC in the United States and other countries.

This device meets the EMC requirements for home appliances (Class B) and is intended for home usage. This device can be used in all regions.



NOTE

- Image shown may differ from your projector.
- Your projector's OSD (On Screen Display) may differ slightly from that shown in this manual.

SAFETY PRECAUTIONS

Please take note of the safety instructions to prevent any potential accident or misuse of the projector.

- Safety precautions are given in two forms, i.e., **WARNING** and **CAUTION** as detailed below.

 **WARNING** Failure to follow the instructions may cause serious injury and even death.

 **CAUTION** Failure to follow the instructions may cause personal injury or product damage.

- Read the owner's manual carefully and keep it on hand.



 The lightning flash with arrowhead symbol, within an equilateral triangle, is intended to alert the user to the presence of uninsulated dangerous voltage within the product's enclosure that may be of sufficient magnitude to constitute a risk of electric shock to persons.

 The exclamation point within an equilateral triangle is intended to alert the user to the presence of important operating and maintenance (servicing) instructions in the literature accompanying the device.

WARNING/CAUTION

- TO REDUCE THE RISK OF FIRE AND ELECTRIC SHOCK, DO NOT EXPOSE THIS PRODUCT TO RAIN OR MOISTURE.

**Read these instructions.
Keep these instructions.
Heed all warnings.
Follow all instructions.**

Indoor Installation

WARNING

- Do not use the projector outside and do not expose the product to any humidity or water.
 - Since the product is not waterproof, this may result in a fire or electric shock.
- Do not place the projector in direct sunlight or near heat sources such as radiators, fires, stoves, etc.
 - This may result in fire.
- Do not place flammable materials such as aerosols near the projector.
 - This may result in fire.

- Do not allow children to cling to or climb up to the projector.
 - This may cause the projector to fall, causing injury or death.
 - Do not install the product in a place with no ventilation (e.g., on a bookshelf or in a closet) or on a carpet or cushion.
 - This may result in fire due to the increase in internal temperature.
 - Do not place the product close to sources of steam, oil or oil mist, such as humidifiers and kitchen counters.
 - Failure to do so may result in fire, electric shock, or corrosion.
 - Do not install the product onto a wall or ceiling that is close to sources of oil or oil mist.
 - The product may be damaged and fall, resulting in serious injury.
 - Do not place the projector where it might be exposed to dust.
 - This may result in fire.
 - Do not use the projector in a damp place such as a bathroom where it is likely to get wet.
 - This may result in fire or electric shock.
 - Do not allow a tablecloth or curtain to block the air vent.
 - This may result in fire due to the increase in the internal temperature.
 - Ensure good ventilation around the projector. The distance between the projector and the wall should be at least 30 cm.
 - This will prevent fire due to the increase in the internal temperature.
-  **CAUTION**
- When placing the projector on a table or shelf, be careful not to put it near the edge.
 - The projector could fall due to balance problems, which may cause personal injury or damage to the product. Make sure to use the projector cabinet or stand that fits the projector.
 - When moving the projector, make sure to switch it off and remove the power plug and cords.
 - The power cord may be damaged, resulting in fire or electric shock.
 - Do not place the projector on an unstable or vibrating surface such as a wobbly shelf or a slope.
 - It may fall and cause injury.
 - Be careful not to tip the projector over when connecting external devices to the projector.
 - This may cause personal injury or damage to the projector.

Power

WARNING

- DISCONNECTING THE DEVICE FROM THE MAIN POWER
 - The Power plug is the disconnecting device. In case of an emergency, the Power Plug must remain readily accessible.
- The grounding wire should be connected. (Except for devices which are not grounded.)
 - Ensure that you connect the grounding cable to avoid electric shock.
If it is not possible to ground the unit, have a qualified electrician install a separate circuit breaker.
Do not try to ground the projector by connecting it to telephone wires, lightning rods, or gas pipes.
- The power plug should be inserted fully into the power outlet.
 - An unstable connection may cause a fire.
- Do not place heavy objects on the power cord.
 - This may result in fire or electric shock.
- Never touch the power plug with wet hands.
 - This may result in electric shock.
- Do not plug too many devices into one multi-power outlet.
 - This may result in fire due to the power outlet overheating.
- Keep the AC adapter, power plug, and the used power outlet clean from dust or foreign materials building up.
 - This may result in fire.
- If there is any smoke or a burning smell from the projector or AC adapter, stop using the product immediately. Disconnect the power cord from the power outlet, and then contact the customer service center.
 - This may result in fire.
- To turn off the main power, remove the power plug, which should be positioned so it is easy to access for operation.

CAUTION

- Always grab the plug to remove the AC adapter or power cord.
 - Otherwise, this may result in a fire or may damage the product.
- Refrain from constantly bending the power cord of the AC adapter.
 - If the power cord is bent excessively for a long period of time, the cord may break inside. This may result in a fire or electric shock.
- Ensure the power cord and plug are not damaged, modified, severely bent, twisted, pulled, sandwiched or hot. Do not use the product if the power outlet is loose.
 - This may result in fire or electric shock.
- Keep the power cord away from heating devices.
 - The wire's sheath may melt, which may result in fire or electric shock.
- Place the projector where people will not trip over or step on the power cord to protect the power cord and plug from any damage.
 - This may result in fire or electric shock.
- Do not turn the projector on or off by plugging in the power plug or unplugging it from the power outlet. (Do not use the power plug as a switch.)
 - This may result in electric shock or damage to the product.
- Do not insert a conductor into the other side of the wall outlet while the power plug is inserted into the wall outlet. In addition, do not touch the power plug immediately after it is disconnected from the wall outlet.
 - This may result in electric shock.
- Only use the official power cord provided by LG Electronics. Do not use other power cords.
 - This may result in fire or electric shock.
- If any water or foreign materials have gone into the AC adapter, power cord, or the interior of the projector, turn off the projector by pressing the power button. Remove all the cables, and then contact the customer service center.
 - This may result in fire or electric shock.

- The surface of the AC adapter is hot. Keep the AC adapter out of the reach of children and avoid touching it during use.
- Never disassemble the power supply devices (AC adapter/ power cord, etc.).
 - This may damage the power cord and result in a fire or electric shock.
- Connect the AC adapter and the power cord firmly.
 - Not doing so may result in a product failure or fire.
- Do not place heavy objects or put pressure on the power cord and AC adapter and avoid damage.
 - This may result in a fire or may damage the product.
- Always use the AC adapter provided or any AC adapters approved and certified by LG Electronics.
 - Any other AC adapter connected may result in the screen flickering.

When in Use

WARNING

- Do not place anything containing liquid on top of the projector such as a vase, flower pot, cup, cosmetics, medicine, or ornaments, candles, etc.
 - This may result in fire or electric shock, or cause injury due to falling.
- In the event that there is a heavy impact or the cabinet is damaged, switch it off, unplug it from the power outlet and contact an authorized service center.
 - This may result in electric shock.
- Do not insert pieces of metal such as coins, hairpins, or metal debris, nor flammable materials such as paper or matches into the projector.
 - This is to prevent electric shock or fire.
- Make sure that a child does not swallow the batteries when you replace the old remote control batteries with new ones. Keep batteries out of reach of children.
 - If a child swallows a battery, consult a doctor immediately.

- Never open any cover on the projector.
 - There is a high risk of electric shock.
- Do not look directly into the lens when the projector is in use.
 - The bright light may damage your eyes.
- When the lamp is on or has just been turned off, avoid touching the air vent or lamp, because these will be very hot.
- If there is a gas leak in the room with the projector, do not touch the projector or power outlet. Open the windows for ventilation.
 - Sparks may cause fire or burns.
- Unplug the power cord from the outlet during a lightning storm.
 - This will prevent shock or damage to the projector.
- Do not use the projector near electronic devices that generate a strong magnetic field.
- Keep the plastic film used for packaging the projector out of the reach of children.
 - If not handled safely, it can cause suffocation.
- Do not keep your hand on the projector for a long time when it is running.
- When you play a game by connecting a game console to a projector, it is recommended that you maintain a distance of more than four times the diagonal length of the screen.
 - Make sure that the connecting cable is long enough. Otherwise, the product may fall causing personal injury or damage to the product.
- Do not place the projector or its remote control with battery in an extremely high temperature environment.
 - This may result in fire.
- Do not use 3D glasses if you do not watch 3D.

 **CAUTION**

- Do not place heavy objects on the projector.
 - It may fall down and cause personal injury.
- Be careful not to allow any impact to the lens during transport.
- Do not touch the lens of the projector.
 - The lens may be damaged.
- Do not use any sharp tools on the projector such as a knife or hammer, because this may damage the casing.
- In the event that no image appears on the screen or no sound is heard, stop using the projector. Switch off the projector, unplug it from the power outlet and contact our service center.
 - This may result in fire or electric shock.
- Do not drop anything onto the projector or allow anything to bang into the projector.
 - This may cause damage to the projector or personal injury.
- It is recommended that you maintain a distance of more than 5 to 7 times the diagonal length of the screen.
 - If you watch the screen at a close distance for a long time, your eye sight may become worse.
- Do not block the light beam emitted from the projector using a book or other object.
 - Lengthy exposure to the projector beam may result in fire. In addition, the lens may be overheated and damaged by the reflected heat. Disable the AV function to stop projection temporarily or turn off the power.
- Do not start the projector with the volume turned up high.
 - High volume may damage hearing.
- Do not use high voltage electrical equipment near the projector, (e.g., a bug zapper). This may result in product malfunction.

Cleaning

WARNING

- Do not spray the projector with water when cleaning. Make sure water does not flow into the projector.
 - This may result in fire or electric shock.
- When there is smoke or a strange smell coming out from the projector or a foreign object falls into the projector, please switch it off and unplug it from the power outlet and contact our service center.
 - Otherwise, this may result in fire or electric shock.
- Use air spray, a soft cloth, or a cotton swab moistened with a lens cleaning chemical or alcohol to remove dust or stains on the front projection lens.

CAUTION

- Contact your seller or our service center once a year to clean the internal parts of the projector.
 - If you do not clean the projector for a long period of time, dust will accumulate, which may result in fire or damage to the projector.
- When cleaning plastic parts such as the projector case, unplug the power first and wipe with a soft cloth. Do not spray with water or wipe with a wet cloth. Never use glass cleaner, automobile or industrial polish, abrasives, wax, benzene, or alcohol as these can damage the projector.
 - This can result in fire, electric shock or cause damage to the product (deformation and corrosion).
- Remove the plug from the outlet before cleaning the product.
 - Otherwise, this may result in electric shock.

Others

WARNING

- Some users may experience a seizure or other abnormal symptoms when they are exposed to a flashing light or particular patterns from a video game.
- When you go out, place the projector out of reach of animals, and remove the power plug from the wall outlet.
 - Using a damaged power cord may result in short circuit or fire.
- Do not use the projector near high-precision electronic devices or those that transmit weak radio signal.
 - This may affect the operation of the product, causing an accident.
- Only a qualified technician can disassemble or modify the projector. For diagnosis, adjustment, or repair, contact your seller or our service center.
 - This may result in fire or electric shock.
- Proper ventilation required, do not block airflow around unit. Doing so can cause injury and internal overheating.
- To prevent damage to lamp, unit must remain plugged in for approximately 3 minutes after power down to allow for proper cool down (not applicable on LED models).
- Do not touch the lens; doing so can result in burns or damage to lens. Lens and unit may be HOT during and immediately after use. Use caution when handling unit, allowing for proper cool down.
- Only use a grounded electrical outlet. (Except for devices which are not grounded.)
- Do not insert anything into or cover up the exhaust vents.
 - This may result in fire or electric shock.
- Follow all maintenance guidelines for optimal use; service only at an authorized service center.
- Lamp contains mercury and as such must be disposed of according to local, state and federal laws (not applicable on LED models).
- Keep the batteries and remote out of reach of children.
 - This will prevent personal injury or damage to the product.

 **CAUTION**

- Do not use or store the projector outdoors for long periods of time.
- Do not mix new batteries with old ones.
 - Burst or leaking batteries may result in damage or injury.
- Be sure to unplug if the projector is not to be used for a long period.
 - Accumulated dust may result in fire or electric shock due to overheating, ignition, or poor insulation.
- Only use the specified type of battery.
 - Burst or leaking batteries may result in damage or injury.
- Make sure you use the same type of battery when replacing.
 - In the case of a battery contact failure, the battery may drain quickly or the remote control may not work properly.
- Dispose of used batteries properly.
 - This may result in explosion or fire. The correct method of disposal may vary depending on your country or region. Dispose of the battery pack as instructed.
- Do not throw or disassemble the battery.
 - This may result in fire or explosion due to damage to the battery.
- Store batteries away from metallic objects, such as keys and paper clips.
 - Excess current may cause a rapid increase in temperature, resulting in fire or burns.
- Do not store the batteries near any heat source, such as a heater.
 - This may result in fire or damage to the product.
- Do not store batteries at temperatures higher than 60 °C or in high humidity.
 - This may result in explosion or fire.
- Make sure that the battery is installed correctly.
 - This may prevent explosion or fire.
- Incorrect battery replacement may cause fire.
- Batteries: Store the accessories (battery, etc.) in a safe location out of the reach of children.

Risk Group 2

CAUTION Possibly hazardous optical radiation emitted from this product. Do not stare at operating lamp. May be harmful to the eye.

CONTENTS

LICENSES	2	Watching Projector	31
SAFETY PRECAUTIONS	3	– Turning on the Projector	31
PREPARATION	15	– Focus of the Screen Image	32
Accessories	15	– Watching With the Projector	32
Optional Extras	16	Additional Options	33
Parts and Components	17	– Adjusting Aspect Ratio	33
– Main Unit	17	– Using the Keystone Function	34
– Side	18	– Changing Input Device	35
– Back	19	– Blank Function	37
Using the Joystick Button	20	Using the Quick Menu	38
– Basic Functions	20	ENTERTAINMENT	39
– Adjusting the Menu	21	Using SCREEN SHARE	39
Projector Status Indicators	21	Setting Up Bluetooth on the Projector	40
Installation	22	– Searching for Bluetooth Devices and Connecting	41
– Installation Precautions	22	– Connecting, Disconnecting, or Deleting Bluetooth Devices in the List of registered devices	43
– Projection Distance per Screen Size	23	– Adjusting AV Sync. Adjust	44
– Kensington Security System	25		
REMOTE CONTROL	26		
USING THE PROJECTOR	29		
Using The Battery	29		
Battery using time information	30		

MY MEDIA	45	CONNECTING DEVICES	91
Before Using	45	Connecting to HD Receiver, DVD Player, or External Devices	92
– Connecting a USB Device	45	– HDMI Connection	92
– Removing a USB Device	45	Connecting a PC	92
To Use My Media	47	– HDMI Connection	92
– Watching the Videos	51	Connecting a Laptop	93
– Viewing the Photos	57	– HDMI Connection	93
– Listening to Music	61	Connecting to Headphones	94
– Viewing Files	65	Using the Mirroring Function of a Mobile Phone	95
		– MHL/Slimport Connection	95
3D FUNCTION	69	MAINTENANCE	96
While Watching 3D	69	Cleaning	96
Requirements for Watching 3D Images	72	– Cleaning the Lens	96
– Using the DLP-LINK (DLP-Ready) Type Glasses	73	– Cleaning the Projector Case	96
To view 3D images	73		
– Supported 3D Mode	74	SPECIFICATIONS	97
CUSTOMIZING SETTINGS	76		
SETTINGS	76		
PICTURE Settings	77		
AUDIO Settings	83		
TIME Settings	85		
WIRELESS Settings	86		
OPTION 1 Settings	88		
OPTION 2 Settings	89		

PREPARATION

The pictures may differ slightly from the actual product.

Accessories

Accessories included with the projector are show below.

Accessories are subject to change without prior notice.

New accessories may be added or old ones removed.



Remote Control,
Two AAA Batteries



Owner's Manual



AC-DC Adaptor



Power cord

- When connecting an HDMI or USB cable, or connecting a USB flash drive to the HDMI or USB port, use a product that has a width of 18 mm or less and a height of 10 mm or less. If the USB cable or USB flash drive does not fit the USB ports of the projector, use an extension cable that supports USB 2.0.
- Use a certified cable with the HDMI logo attached.
- If you do not use a certified HDMI cable, the screen may not display or a connection error may occur. (Recommended HDMI cable types)
 - High-Speed HDMI®/™ Cable
 - High-Speed HDMI®/™ Cable with Ethernet

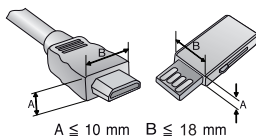

Optional Extras

To purchase optional accessories, visit an electronics store or online shopping site or contact the retail store where you purchased the product. Optional accessories are subject to change without prior notice.



Projection Screen



HDMI Cable



3D glasses
(DLP-LINK or DLP
Ready Type)



MHL or Slimport cable

Parts and Components

This projector is manufactured using high-precision technology. You may, however, see tiny black dots and/or bright colored dots (red, blue, or green) that continuously appear on the projector screen. This is a normal result of the manufacturing process and does not indicate a malfunction.

Main Unit

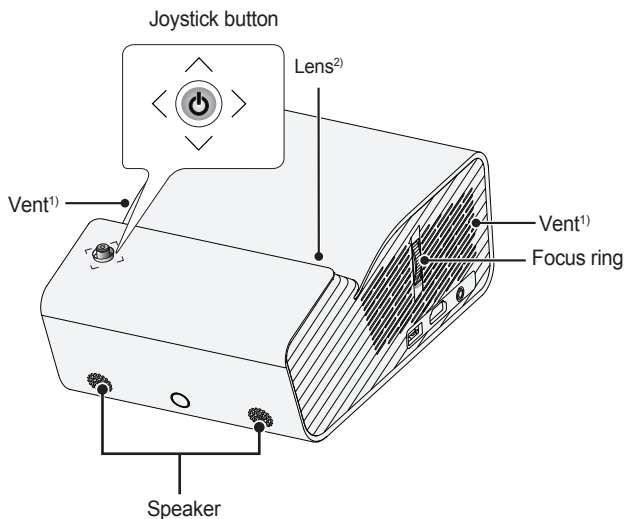

- 1) Due to the high temperature of vent area, do not get close to the vent area.
- 2) Do not touch the lens when using the projector. The lens may be damaged.
(Keep lens away from sharp objects.)

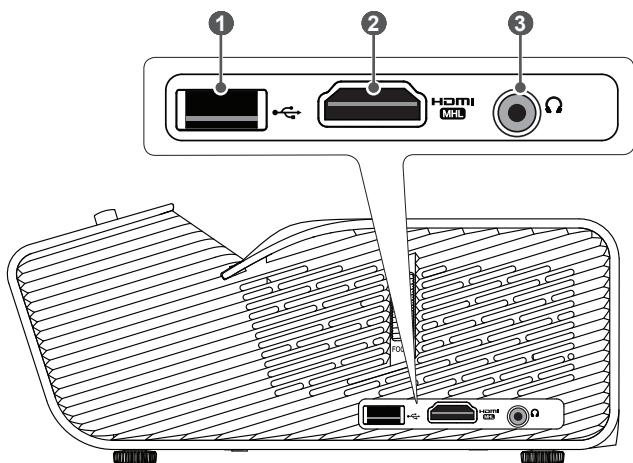
Side

	Description
①	🔌 (USB Port)
②	HDMI MHL Port
③	🎧 (Headphone Port)

Back

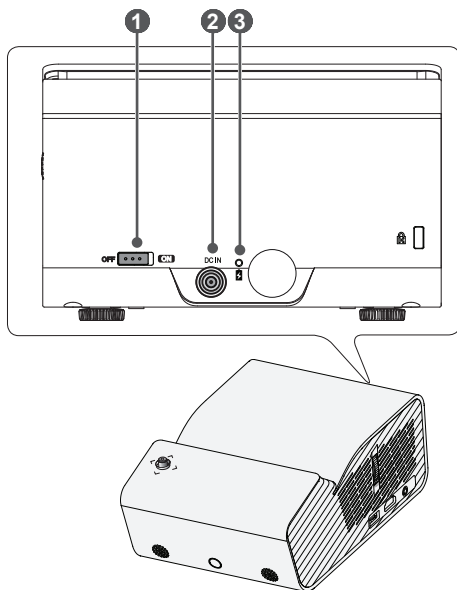



	Description
1	<p>OFF ON Switch</p> <ul style="list-style-type: none"> – OFF: Turns the projector off completely. – ON: Turns the projector on and the projector goes into Standby mode. <p>Place the switch to OFF when you move the projector or when you intend not to use the projector for long periods of time.</p>
2	DC IN Port
3	<p>Battery Charge Indicator</p> <ul style="list-style-type: none"> – Red: Charging – Green: Charging complete

Using the Joystick Button

You can operate the projector by pressing the button or moving the joystick left, right, up, or down.

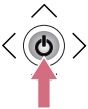
Basic Functions

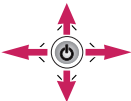
	Power On	When the projector is turned off, place your finger on the joystick button, press it once, and release it.
	Power Off	When the projector is turned on, place your finger on the joystick button, press it once for a few seconds, and release it. (However, if the menu button is on the screen, pressing and holding the joystick button will let you exit the menu.)
	Volume Control	Place your finger over the joystick button and move it left or right. You can adjust the volume level.
	Up/Down/Left/Right	If you move the joystick up, down, left, or right, you can move the cursor to select the menu items.







NOTE

- Move the joystick button up, down, left, or right. Be careful not to press the joystick button. If you press the button while moving the joystick, the volume control may not work, and the cursor may not move.

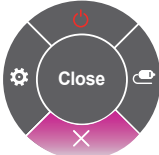
Adjusting the Menu

When the projector is turned on, press the joystick button one time. You can adjust the menu items (⏻, 📺, ✕, ⚙️) moving the joystick button left, right, up, or down. Move to the desired menu item, and then press the joystick button once to select it.

		Projector off	Turns the power off.
		Input List	Changes the input source.
		Close	Clears on-screen displays and returns to projector viewing.
		Settings	Displays the Settings menu.

Projector Status Indicators

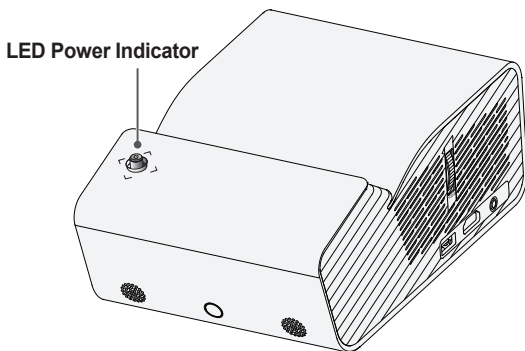

LED Power Indicator	
Red	Power standby state
Off	The projector is operating with the power on.

Installation

Installation Precautions

- Place the projector in a well-ventilated environment.
 - To prevent internal overheating, install the projector in a well-ventilated place. Do not place anything near the projector that may block its air vents. If the air vents are blocked, the internal temperature of the projector will increase.

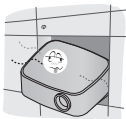

- Do not place the projector on a carpet or rug. If the projector's inlet vent is on the bottom, be careful not to block the vent and always use the projector on a solid, level surface.



- Be sure to prevent foreign objects such as paper debris from entering the projector.



- Leave an adequate open area (30 cm or more) around the projector.

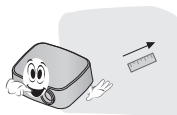

- Do not place the projector in a hot, cool, or humid environment.
- Do not place the projector in a place where it will easily attract dust.
 - This may result in fire.
- Never open any cover on the projector. There is a high risk of electric shock.
- The projector is manufactured using high-precision technology. You may, however, see tiny black dots and/or bright colored dots (red, blue or green) that continuously appear on the projector screen. This is a normal result of the manufacturing process and does not indicate a malfunction.
- The remote control may not work in an environment where a lamp equipped with electronic ballasts or a three-wavelength fluorescent lamp is installed. Replace the lamp with an international standard lamp for the remote control to work normally.

Projection Distance per Screen Size

- 1** Place the projector on a sturdy, level surface, together with the PC or audio/video source.
- 2** Place the projector an appropriate distance away from the screen. The distance between the projector and the screen determines the actual size of the image.
- 3** Position the projector so that the lens is at a right angle to the screen. If the projector is not at a right angle, the projected image will look distorted. To correct the distortion, use the keystone function. (See page 34.)
- 4** Connect the power cord of the projector and the connected device to the wall outlet.

Ratio of upward projection: 120 %

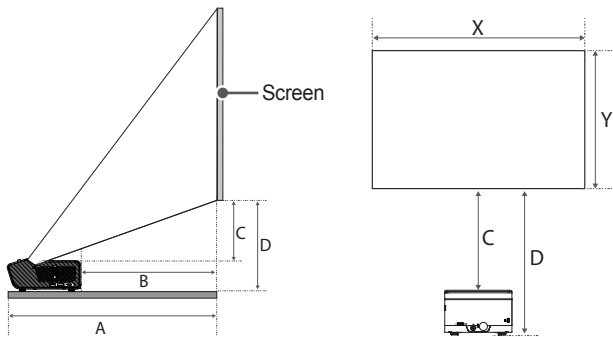

Screen Size [mm] (16:9 Aspect Ratio)	Horizontal Size (X) x Vertical Size (Y) [mm]	A [mm]	B [mm]	C [mm]	D [mm]
1016	886 x 498	274	74	69	161
1143	996 x 560	306	106	81	173
1270	1107 x 623	338	138	94	186
1397	1218 x 685	370	170	106	198
1524	1328 x 747	402	202	119	211
1651	1439 x 809	434	234	131	223
1778	1550 x 872	466	266	144	236
1905	1660 x 934	498	298	156	248
2032	1771 x 996	531	330	169	260

The projection distance may vary depending on the installation conditions.



CAUTION

- If the projected image looks distorted or bent, check to see if the screen is installed properly.

Kensington Security System

- This projector has a Kensington Security Standard connector as an anti-theft mechanism. Connect a Kensington Security System cable as shown below.
- For more information on installation and use of the Kensington Security System, refer to the user's guide provided with the Kensington Security System.
- The Kensington Security System is an optional accessory.
- What is Kensington?

Kensington is a company that provides safety systems for laptops and other electronic devices. Website: <http://www.kensington.com>

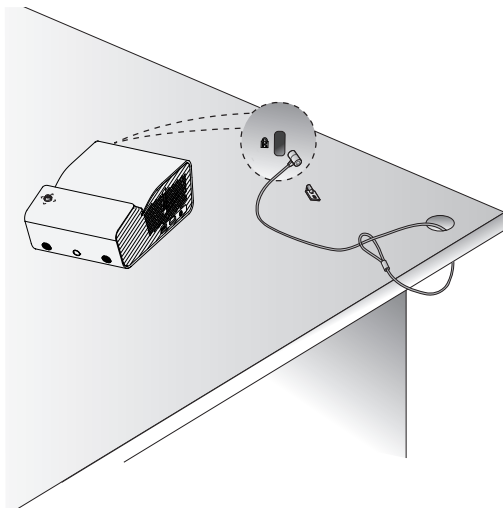

REMOTE CONTROL

Open the battery cover on the back of the remote control and insert the batteries which are specified in the battery room with \oplus \ominus poles pointing in the correct direction.

Use new batteries and do not mix regular or rechargeable batteries. (1.5 V AAA)

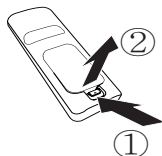

CAUTION

- Do not mix new batteries with old ones.

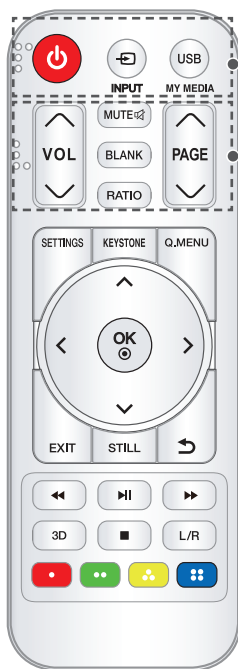

(POWER)

Turns the projector on or off.

INPUT

Changes the input source.

USB/MY MEDIA

Accesses USB mode.

VOL ,

Adjusts the volume level.

MUTE

Mutes the sound of the projector.

BLANK

Displays a blank screen.

RATIO

Changes the aspect ratio of the screen per pressing of the button.

PAGE ,

Moves to the previous/next page.

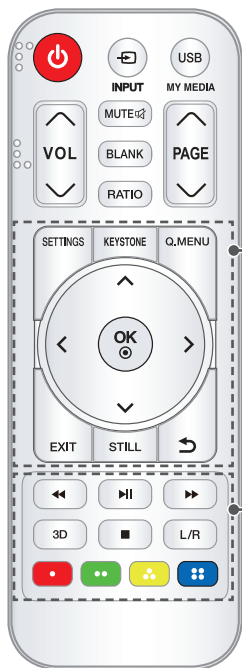
**SETTINGS**

Displays or closes the Settings menu.

KEYSTONE

Adjusts the Keystone function.

Q.MENU

Enters the quick menu.

Up/Down/Left/Right buttons

Sets the function or moves the cursor.

OK

Shows the current mode and saves changes to the settings.

EXIT

Exits the menu.

STILL

Freezes the moving image.

(Available in any mode other than USB mode.)

↶ (BACK)

Returns to the previous screen.

Playback control buttons

Controls playback of **MY MEDIA**.

3D

Shows 3D images.

L/R

Switches left and right in 3D mode.

Color buttons

Sets detailed settings or gesture for each menu.

! NOTE

- When using the remote control, the optimal operation range is 6 meters or less (left/right) and within a 30 degree arc of the remote control IR receiver.
- For seamless operation, do not block the IR receiver.
- When you carry the remote control in the portable bag, make sure that the buttons on the remote control are not pressed by the projector, cables, documents, or any other accessories in the bag. Otherwise, it may significantly reduce the battery life.

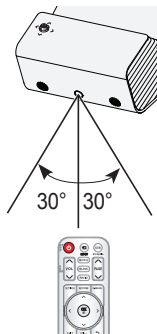

USING THE PROJECTOR

Using The Battery

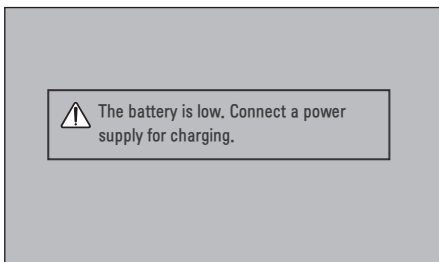

- It is displayed when the battery is low (Energy Saving will be changed Maximum mode and will be disabled).
- If the screen shows a low battery message, be sure to charge the battery.

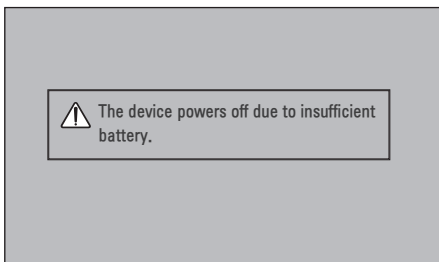

- It is displayed when the battery is running out.
- As your battery is running out, the projector will turn off immediately.
- If the battery runs out, the projector can only be turned on after it has been connected to a power supply.

Battery using time information

Status	Time and Display
Charging	About 3 hours
Usage Hours	Up to 2.5 hours (Available battery using time up to 2.5 hours when Energy Saving mode set to Max.)
Battery Level Indicator	 Step 1 Step 2 Step 3 Step 4 Step 5 Full

- If you do not intend to use the projector for a long time, leave the battery charged at 40 % to 50 %.
- The battery is automatically recharged when the projector is connected to a power supply.
- Charge the battery fully when you first use the projector.
- The battery standard usage time given in the manual is based on measurements taken by LG; the actual time may vary depending upon usage.
- Battery usage time may vary depending on broadcast type, operating temperature, period of use, and user preferences.
- As the battery is consumable, its lifetime gradually decreases. When the battery's life is reduced by half, replace it with a new battery from an LG Electronics Customer Support Center.
- Do not charge the battery using any equipment other than that supplied with the product. This may damage the battery or cause a fire.
- Always use a battery that is approved and certified by LG Electronics, Inc. Failure to do so may result in an explosion or fire.
- If the battery is leaking or giving off an odor, discontinue its use immediately and contact LG Electronics Customer Support Center.
- The battery contains lithium-ion, so please handle with care. Failure to do so may result in an explosion or fire.

Watching Projector

Turning on the Projector

The menu screen display in this owner's manual is an example to help users understand how to operate the product and may look different from the actual screen.

- 1 Connect the power cord correctly.
- 2 Place the **OFF ON** switch on the rear port area to **ON** and press the **POWER** button on the joystick button or on the remote control. (If the switch is placed to **OFF**, the projector will not turn on.)
- 3 In the Language Selection screen, select a language.
- 4 In the **Mode Setting** screen, select the setting mode you want.

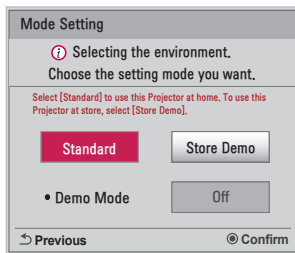

* **Store Demo** is used when displaying the product in-store. The picture mode is automatically reset after a certain period of time. You can select **Standard** to use the product at home.

- 5 Select an input signal by using the  **INPUT** button on the remote control.

Focus of the Screen Image

When an image appears on the screen, check if it is in focus and fits the screen properly.

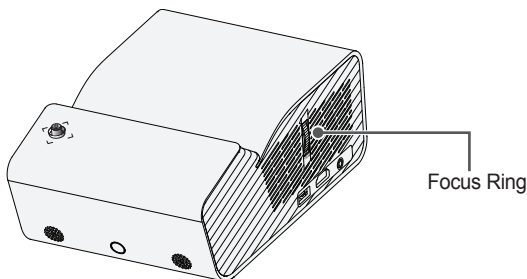

- To bring images into focus, move the Focus Ring slowly up or down, concentrating on the upper central part of the screen. Optimal focus is reached when the left and right sides of the screen appear balanced.

Watching With the Projector

- 1 When in standby mode, press the **POWER** button to turn the projector on.
- 2 Press the **INPUT** button and select the input signal you want.
- 3 Control the projector using the following buttons while watching projector.

Button	Description
VOL ^, v	Adjusts the volume level.
MUTE	Mutes all sounds.
Q.MENU	Accesses the quick menu.
RATIO	Resizes an image.
KEYSTONE	Adjusts Keystone.

- 4 To turn the projector off, press the **POWER** button.

Additional Options

Adjusting Aspect Ratio

Resize an image to view at its optimal size by pressing **RATIO** while you are using the projector.



NOTE

- Available picture size may differ depending on the input signal.
- You can also use the **Q.MENU** or **SETTINGS** button.

Menu	Description
16:9	Resizes images to the 16:9 ratio.
Just Scan	<p>Displays video images in the original size without removing parts of the edge of the image.</p> <ul style="list-style-type: none"> • If you select Just Scan, you may see image noise at the edge or edges of the screen.
Set By Program	Displays images in the same aspect ratio as the original image.
4:3	Resizes images to the previous standard 4:3.
Zoom	<p>Resizes the image to fit the screen width. The top and bottom parts of the image may be cut off.</p> <ul style="list-style-type: none"> • Press the < or > button to zoom in or out of the image. • Press the ^ or v button to move the image.
Cinema Zoom 1	<p>Formats an image to the cinemascope ratio, 2.35:1. It ranges from 1 to 16.</p> <ul style="list-style-type: none"> • Press the < or > button to zoom in or out of the image. • Press the ^ or v button to move the image. • If you enlarge or reduce an image, the image may be distorted.

Using the Keystone Function

To prevent the screen image from becoming trapezoidal, **Keystone** adjusts the top and bottom width of the image if the projector is not set up at a right angle to the screen.

Because the **Keystone** function may cause inferior screen image quality, use this function only when it is not possible to set up the projector at an optimal angle.

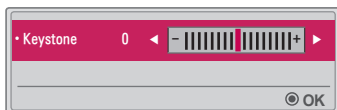



- 1 Press the **KEYSTONE** button to adjust the picture.
 - **Keystone** values differ depending on the **PJT Mode** of **OPTION 2**.
- 2 Press the **OK**  button when done.

Changing Input Device

To select an external input

Selects external input.

The illustration of the menu may differ from the actual screen on the product.

- Press the  **INPUT** button on the remote control to display the input selection screen.
 - Connected inputs are displayed first. However, **SCREEN SHARE** input is always activated.
- Select an input signal using the remote control's  **INPUT** button to connect the projector to the desired input.

You can use the \langle or \rangle button to switch between all the input modes.



Selecting an Input Label

Displays which devices are connected to which input ports.

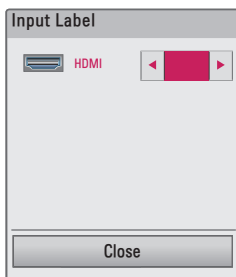

- 1 Press the **INPUT** button on the remote control to display the input selection screen.
- 2 Press the **Red** button.
- 3 Use the **<** or **>** button to select one of the input labels.

Blank Function

Using the Blank Function

This function may be effective when you need to draw attention during a meeting or training.

- 1 Press the **BLANK** button, and the screen is covered by the background color. You can change the background color by referring to *Selecting a Blank Image*.
- 2 Press any button to clear the blank function. To cover the screen temporarily, press the **BLANK** button on the remote control. Do not block the lens with any object while the projector is running. It may become overheated and deformed or even cause a fire.

Selecting a Blank Image

- 1 Press the **SETTINGS** button.
- 2 Press the \wedge , \vee , \lt , or \gt buttons to select **OPTION 2** and press the **OK** \odot button.
- 3 Press the \wedge , \vee buttons to select **Blank Image** and press the **OK** \odot button.
- 4 Press the \wedge or \vee button to move to the setting or option you want and press the **OK** \odot button.

Using the Quick Menu

You can easily customize your frequently used menus.

- 1 Press the **Q.MENU** button.
- 2 Press the **<** or **>** button to select a menu and press **OK**  button.

Menu	Description
Aspect Ratio	Resizes the picture.
PJT Mode	Turns the projected image upside down or flips it horizontally.
Picture Mode	Changes the picture mode.
Sound Mode	Sets the sound mode.
Sleep Timer	Sets the projector to be turned off at the specified time.
Clear Voice II	Makes the voice from the projector crisp and clear.
Energy Saving	Reduces power consumption by adjusting peak screen brightness. (If the screen shows a low battery message, Energy Saving will be changed Maximum mode and will be disabled)
USB Device	Allows you to remove a connected USB device in a safe manner. (The menu is displayed only when the USB device is connected.)

- 3 Press the **^** or **v** button to scroll through the following menus.

ENTERTAINMENT

Using SCREEN SHARE

- 1 Set the external input of the projector to **SCREEN SHARE**.
- 2 Enable related SCREEN SHARE function on the device you wish to connect.
- 3 Connect the projector from the search list on the device you wish to connect. (When you connect the projector to your laptop, input the PIN code shown on your display. The request for a PIN will be shown only at the initial connection.)
- 4 If the desired device accepts the request, SCREEN SHARE will be started.



CAUTION

- Windows 7 / 8 / 8.1 / 10 are compatible with SCREEN SHARE. However, other versions of Windows, and some other operating systems, may not be compatible with SCREEN SHARE.
- Ice Cream Sandwich, Jellybean, Kitkat, Lollypop, and Marshmallow versions of LG's Android devices are guaranteed to be compatible.
- When connecting via SCREEN SHARE, place the device close to the projector.
- The response rate and image quality may vary depending upon the user's environment.
- For more information on the device you want to connect to, refer to its owner's manual.
- Certain Windows 8.1 laptops may have difficulty in reconnecting when initializing the device information during a wireless connection. In this case, it is recommended that you remove the registered device and reconnect.

Setting Up Bluetooth on the Projector

This option is used to output sound from the projector through Bluetooth audio devices.

- Press the **SETTINGS** button on the remote control, and then set **Bluetooth** to **On** in the **WIRELESS** menu.

! NOTE

- The devices that can be connected are as follows: LG BTS1, LG HBS-700, LG HBS-730, LG HBS-800 (Models available for purchase may vary by region.)
- Products from other manufacturers may not be compatible.
- You can use the remote control to adjust the volume of the connected device.
- When connecting devices wirelessly, if the device connection fails, check that the device is connected to a power supply and also check that the Bluetooth audio device is operating properly.
- If **Bluetooth** is turned on, the projector will automatically connect to the last connected Bluetooth device when the projector powers on. (Be sure to check that the last connected Bluetooth device is powered on as well.)
- This projector does not support the LG TV Sound Sync feature. To use products that support the LG TV Sound Sync feature, use the general Bluetooth mode instead of the LG TV mode.
- The Bluetooth function is to connect the product to Bluetooth speakers or Bluetooth headset. You cannot connect the product to a mobile phone through the Bluetooth function.

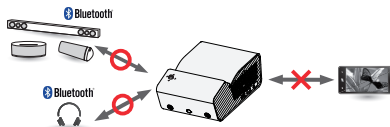

Searching for Bluetooth Devices and Connecting

Go to **SETTINGS** → **WIRELESS** → **Search Device** to search for nearby Bluetooth audio devices and then connect any detected devices to the projector.

(If the device name is longer than 20 characters, no more than 20 will be displayed.)

- 1 Set the Bluetooth device to pairing mode and then select **Search Device**.
 - Select **Stop searching** to view the devices detected so far.
 - If the device has not been detected, check that the device is powered on and in pairing mode.
 - The time it takes to search for devices may vary according to the signal strength and the number of devices.

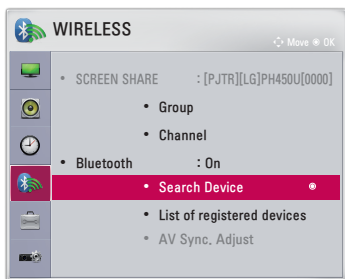

2 When the search is complete, you can select a Bluetooth device and connect to it.

- You can stop the connection process immediately by selecting **Stop searching**.
- The time it takes to connect to a device may vary according to the signal strength and the number of devices.

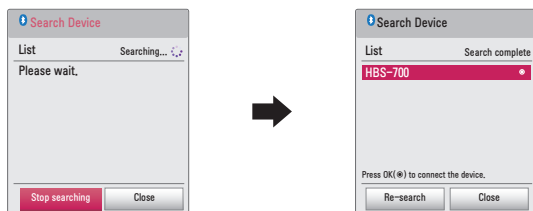

3 When a Bluetooth device is connected, you will hear sound from the projector through the connected device.

- The connected Bluetooth device will be added automatically to the **List of registered devices**. Once registered, Bluetooth devices can be connected simply by selecting them from the **List of registered devices** without having to search for them.
- Connected devices can only be disconnected from **SETTINGS** → **WIRELESS** → **List of registered devices**.

Connecting, Disconnecting, or Deleting Bluetooth Devices in the List of registered devices

In **SETTINGS** → **WIRELESS** → **List of registered devices**, Bluetooth devices are shown in the order that they were connected, and the same devices can be reconnected simply by selecting them without having to search for them again.

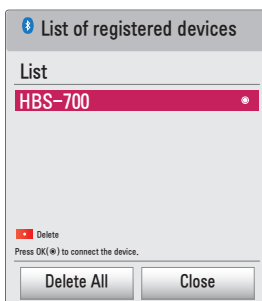

Connecting

Select a Bluetooth device from the **List of registered devices** to connect to it.

- The registered Bluetooth device will attempt to connect automatically depending on the characteristics of the device. (Refer to the manual for the Bluetooth device.)
- You can stop the connection process immediately by selecting **Stop**.
- The time it takes to connect to a device may vary according to the signal strength and the number of devices.

Disconnecting

Select **Disconnect** to disconnect the device.

- You can only disconnect a device from the **List of registered devices**.

Deleting

Select **Delete Marked** or **Delete All** to delete any registered devices.

- **Delete Marked:** Press the **red** button in **List of registered devices** to delete the selected device.
- **Delete All:** Select **Delete All** in **List of registered devices** to delete all of the registered devices.

Adjusting AV Sync. Adjust

When a Bluetooth device is connected, go to **SETTINGS** → **WIRELESS** → **AV Sync. Adjust** to adjust the synchronization between the video and the Bluetooth headset sound.

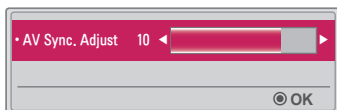

- This feature is only available when a Bluetooth device is connected.
- Audio sync may vary by manufacturer.
- When playing video from a connected USB drive, **AV Sync. Adjust** can also be adjusted using the **Set Audio.** menu.

MY MEDIA

Before Using

Connecting a USB Device

Connect a USB device (external HDD, USB memory) to the USB port of projector to enjoy the content files stored in the USB device with your projector. You cannot write or delete data in the USB device. Connect a USB flash drive as shown below.

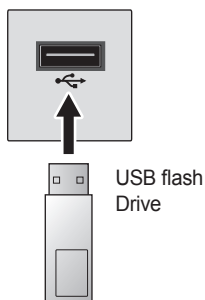

Removing a USB Device

- 1 Click the **Q.MENU** button.
- 2 Use the **<** or **>** button to move to **USB Device** and press the **OK** button.
- 3 Select a USB to remove. Wait for confirmation that the USB device has stopped before removing the USB.



NOTE

- If detached early, an error may occur on the projector or the USB storage device.
- Once a USB device has been selected for removal, it can no longer be read. Remove the USB storage device and then re-connect it.

Tips for using a USB device

- If the USB storage device has a built-in auto recognition program or uses its own driver, it may not work.
- Some USB storage devices may not work or may work incorrectly.
- If you use a USB extension cable, the USB device may not be recognized or may not work properly.
- Use only USB storage devices formatted with the Windows FAT32 or NTFS file system.
- For external USB HDDs, it is recommended that you use devices with a rated voltage of less than 5 V and a rated current of less than 500 mA.
- It is recommended to use a Hard Disk Drive with its own power supply. (If the power being supplied is not sufficient, the USB storage device may not be detected correctly). Note, a USB Hub is not supported.
- It is recommended that you use USB flash drives of 32 GB or less and USB HDDs of 2 TB or less.
- If a USB HDD with power-saving function does not work properly, turn the power off and on. For more information, refer to the user manual of the USB HDD.
- Data in USB storage device can be damaged so be sure to back up important files to other devices. Data maintenance is the user's responsibility and the manufacturer is not responsible for data loss.

To Use My Media

1 Press the **SETTINGS** button on the remote control.

2 Select **MY MEDIA**.

Select desired file from the list. Watch the chosen file.

Sets play related settings by checking option during disk playback.

My Media supporting file

- Maximum data transmission rate: 20 Mbps (Mega bit per second)
- External supported subtitle formats: *.smi, *.srt, *.sub (MicroDVD, SubViewer 1.0/2.0), *.ass, *.ssa, *.txt (TMPlayer), *.psb (PowerDivX)
- Internal supported subtitle formats: SRT/ASS/SSA (Supports internal subtitles generated from DivX6)

Video Supported Codec

Maximum: 1920 x 1080 @ 30p (only Motion JPEG 640 x 480 @ 30p)

Extension	Codec	
.asf .wmv	Video	VC-1 Advanced Profile, VC-1 Simple and Main Profiles
	Audio	WMA Standard, WMA 9 Professional
.divx .avi	Video	DivX3.11, DivX4, DivX5, DivX6, XVID, H.264/AVC
	Audio	MPEG-1 Layer I, II, MPEG-1 Layer III (MP3), Dolby Digital
.mp4 .m4v .mov	Video	H.264/AVC, MPEG-4 Part 2
	Audio	AAC
.mkv	Video	H.264/AVC
	Audio	HE-AAC, Dolby Digital
.ts .trp .tp .mts .m2ts	Video	H.264/AVC, MPEG-2, VC-1
	Audio	MPEG-1 Layer I, II, MPEG-1 Layer III (MP3), Dolby Digital, Dolby Digital Plus, AAC
.vob	Video	MPEG-1, MPEG-2
	Audio	Dolby Digital, MPEG-1 Layer I, II, DVD-LPCM
.mpg .mpeg	Video	MPEG-1
	Audio	MPEG-1 Layer I, II

Audio File

File type	Item	Info
MP3	Bit rate	32 kbps to 320 kbps
	Sampling rate	32 kHz to 48 kHz
AC3	Bit rate	32 kbps to 640 kbps
	Sampling rate	32 kHz, 44.1 kHz, 48 kHz
MPEG	Bit rate	32 kbps to 448 kbps
	Sampling rate	32 kHz to 48 kHz
AAC, HEAAC	Bit rate	24 kbps to 3844 kbps
	Sampling rate	8 kHz to 96 kHz
CDDA	Bit rate	1.44 kbps
	Sampling rate	44.1 kHz
LPCM	Bit rate	1.41 Mbps to 9.6 Mbps
	Sampling rate	Multi-channel : 44.1 kHz, 88.2 kHz / 48 kHz, 96 kHz Stereo : 176.4 kHz, 192 kHz

Available photo file

File type	Item	Info
2D (jpeg, jpg, jpe), 3D (jps)	Support File type	SOF0: Baseline, SOF1: Extend Sequential, SOF2: Progressive
	Picture Size	Minimum: 64 x 64 Maximum: Normal Type: 15360 (W) x 8640 (H) Progressive Type: 1920 (W) x 1440 (H)
3D (mpo)	Support File type	MPO
	Picture Size	4:3 size : 3648 x 2736, 2592 x 1944, 2048 x 1536 3:2 size : 3648 x 2432
BMP	Picture Size	Minimum: 64 x 64 Maximum: 9600 (W) x 6400 (H)
PNG	Support File type	Interlace, Non-Interlace
	Picture Size	Minimum: 64 x 64 Maximum: Interlace: 1200 (W) x 800 (H) Non-Interlace: 9600 (W) x 6400 (H)

* BMP and PNG format files may be slower to display than JPEG.

Watching the Videos

In the **Movie List**, you can watch movies stored on the connected USB device.

Controls playback and sets options while viewing videos.

Tips for Playing Video Files

- Some subtitles created by users may not work properly.
- The video and subtitle files should be placed in the same folder. For subtitles to display correctly, the video and subtitle files must have the same name.
- We do not support any stream that contains GMC (Global Motion Compensation) or Qpel (Quarterpel Motion Estimation).
- Only H.264/AVC profile level 4.1 and lower is supported.
- Video files that exceed 50 GB (gigabyte) are not supported for playback. The file size limit is dependent on the encoding environment.
- DTS audio codec is not supported.

Browsing Movie List

Play a video file stored from a connected device.

- 1 Connect a USB storage device.
- 2 Press the **USB/MY MEDIA** button.
- 3 Use the **<**, or **>** button to select **Movie List** and press the **OK** button.
- 4 Use the **^**, **v**, **<**, or **>** button to select the file you want and press the **OK** button.

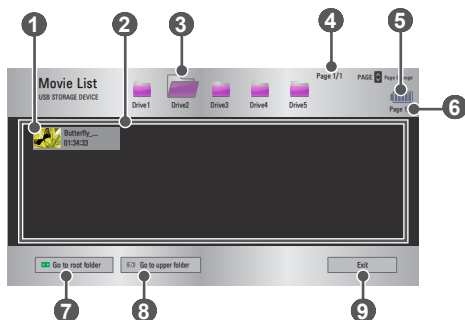

No.	Description	
1	Thumbnails	
	Abnormal file	
	File not supported	
2	File List	
3	Moves to the upper level folder.	
4	Current page/Total no. of folder pages	
5	Displays the remaining battery life.	
6	Current page/Total no. of file pages	

No.	Description
7	Moves to the top level folder.
8	Moves to the upper level folder.
9	Exit Movie List.

5 Control playback by using the following buttons.



Item	Description
◀▶	Shows the current playing position. Use < or > buttons to move forward or backward.
■	Stops playing and returns to Movie List.
▶	Returns to normal playback.
	Pauses the media player. If no button is pressed on the remote control for 10 minutes after pausing, the playback is restarted.
▶▶	Displays in slow motion.
◀◀◀	Whenever this button is pressed, the playback speed is changed.: x2, x4, x8, x16, x32
e	Reduces power consumption by adjusting peak screen brightness. (If the screen shows a low battery message, Energy Saving will be changed Maximum mode and will be disabled)
3D	Switches to the 3D screen.
Option	A pop-up window will appear.
Hide	Hides the playback bar. Press the OK button to make it appear.
Exit	Returns to the Movie List screen.

Options for Movie List

- 1 Press the **Q.MENU** button.
- 2 Use the \wedge or \vee button to move to a desired option and press the **OK** \odot button.
- 3 Use the \wedge , \vee , $<$, or $>$ button to set up each item.

Set Video Play.

Item	Description
Picture Size	<p>Selects the size of a playback screen.</p> <ul style="list-style-type: none"> • Full: Files are played in full screen mode according to the aspect ratio of video. • Original: Displays the video in the original size.
Audio Language	<p>Allows you to select the language you want for the file with multiple audio tracks. This option is not available if the file has only one audio track.</p>
Subtitle Language	<p>The subtitle can be turned on or off.</p> <ul style="list-style-type: none"> • Language: One of any of the available languages can be selected. • Code Page: A character set used for a subtitle can be selected. By default, the subtitle is displayed in a language configured in OPTION 1 \rightarrow Language. <ul style="list-style-type: none"> – Sync: If a subtitle is not synchronized with its video, you can adjust its speed at 0.5 seconds unit. – Position: Moves the location of a subtitle. – Size: Changes the subtitle font size.
Repeat	<p>Turns the repeat function On or Off. When it is set to off, the next file can be played sequentially if the file name is similar.</p>

Set Video.

You can change video settings. (Refer to **PICTURE Settings** on page 77.)

Set Audio.

You can change audio settings. (Refer to **AUDIO Settings** on page 83.)

BLUETOOTH

You can change Bluetooth settings. (Refer to **Setting Up Bluetooth** on the Projector on page 40.)

Set 3D Video

You can set 3D video or 2D video.

3D setting

You can set 3D settings. (Refer to **OPTION 1 Settings** on page 88.)

Registering the DivX code

Checks DivX Reg. Code for replaying DivX protected videos. Register at <http://vod.divx.com>.

Use Reg. Code to rent or purchase movies at www.divx.com/vod.

- 1 In the Settings menu, move to **OPTION 1** and press **DivX(R) VOD**.

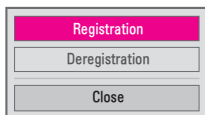

- 2 Press the \wedge or \vee button to move to **Registration** and press the **OK** button.

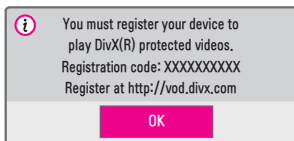

- 3 Check the DivX **Registration code**.



NOTE

- Rented/purchased DivX files cannot be played if the DivX Registration Code of a different device is used. Use only the DivX Registration Code granted to this specific device.
- Converted files not conforming to the DivX Codec Standard may not play or may produce abnormal sound.

To deregister the DivX code

Use the DivX deregistration code to deactivate the DivX DRM function.

- 1 In the Settings menu, move to **OPTION 1** and press **DivX(R) VOD**.
- 2 Use the **^** or **v** button to go to **Deregistration** and press the **OK** button.

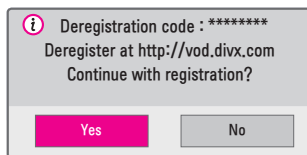
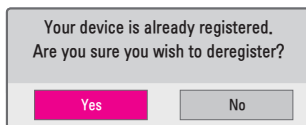
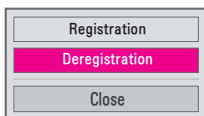

- 3 Select **Yes**.



NOTE

- What is DRM [Digital Rights Management]?
DRM technologies and services protect the interests and rights of copyright holders by preventing illegal use of digital content. Files can be played after the license is verified through an online method, etc.

Viewing the Photos

You can view photos stored on a connected device.

Supported Photo Files

PHOTO (*.JPEG)

Baseline: 64-pixel (width) x 64-pixel (height) - 15360-pixel (width) x 8640-pixel (height)

Progressive: 64-pixel (width) x 64-pixel (height) - 1920-pixel (width) x 1440-pixel (height)

- Non-supported files are displayed in the form of an icon.
- An error message is displayed for corrupted files or file formats that cannot be played.
- Corrupted files may not be displayed properly.
- It may take some time to view high-resolution images in full screen.

Browsing Photo List

- 1 Connect a USB storage device.
- 2 Press the **USB/MY MEDIA** button.
- 3 Use the **<** or **>** buttons to select **Photo List** and press the **OK** button.
- 4 Use the **^**, **v**, **<**, or **>** button to select the file you want and press the **OK** button.

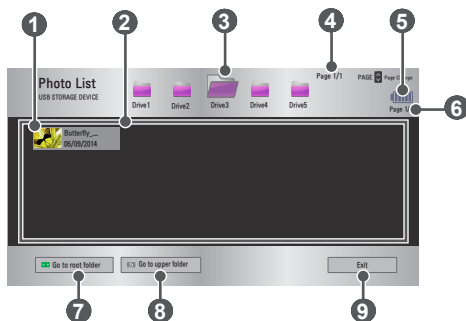

No.	Description	
1	Thumbnails	
	Abnormal file	
	File not supported	
2	File List	
3	Moves to the upper level folder.	
4	Current page/Total no. of folder pages	
5	Displays the remaining battery life.	
6	Current page/Total no. of file pages	
7	Moves to the top level folder.	
8	Moves to the upper level folder.	
9	Exits Photo List.	

5 Control playback by using the following buttons.



Item	Description
	Selects the previous or next photo.
Slideshow	All photos are displayed during slide show. <ul style="list-style-type: none"> Set Slide Speed in the Option → Set Photo View. menu.
BGM	You can listen to music while viewing photos in full size. <ul style="list-style-type: none"> Set the BGM in the Option → Set Photo View. menu.
	Rotates photos. <ul style="list-style-type: none"> Rotates a photo 90°, 180°, 270°, 360° clockwise. Photos cannot be rotated if their width is greater than the height of the max. supported resolution.
	Views the photo in full mode or original mode. Press the blue button to enlarge the image.
	Reduces power consumption by adjusting peak screen brightness. (If the screen shows a low battery message, Energy Saving will be changed Maximum mode and will be disabled)
	Switches to the 3D screen.
Option	A pop-up window will appear.
Hide	Hides the menu on the full size screen. <ul style="list-style-type: none"> To see the menu, press the OK button on the remote control.
Exit	Exit from full screen photo view.

Options for Photo List

- 1 Press the **Q.MENU** button.
- 2 Use the \wedge or \vee button to move to a desired option and press the **OK** \odot button.
- 3 Use the \wedge , \vee , $<$, or $>$ button to set up each item.

Set Photo View.

Item	Description
Slide speed	Selects a slideshow speed.
BGM	Selects a music folder for the background music. <ul style="list-style-type: none"> • You cannot change the music folder while the background music is playing. • For background music, only the folder from the same device can be selected. <ul style="list-style-type: none"> – Repeat: Selects repeat play. – Random: Selects random play.

Set Video.

You can change video settings. (Refer to *PICTURE Settings* on page 77.)

Set Audio.

You can change audio settings. (Refer to *AUDIO Settings* on page 83.)

BLUETOOTH

You can change Bluetooth settings. (Refer to *Setting Up Bluetooth on the Projector* on page 40.)

Set 3D Video

You can set 3D image or 2D image.

3D setting

You can set 3D settings. (Refer to *OPTION 1 Settings* on page 88.)

Listening to Music

You can play audio files stored on the connected device.

Supported Music Files

*.MP3



Bit rate range 32 Kbps to 320 Kbps

- Sampling rate MPEG1 Layer3: 32 kHz, 44.1 kHz, 48 kHz
- Sampling rate MPEG2 Layer3: 16 kHz, 22.05 kHz, 24 kHz

Browsing Music List

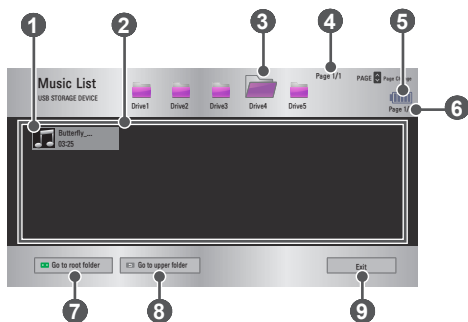
- 1 Connect a USB storage device.
- 2 Press the **USB/MY MEDIA** button.
- 3 Use the **<** or **>** button to select **Music List** and press the **OK** button.
- 4 Use the **^**, **v**, **<**, or **>** button to select the file you want and press the **OK** button.

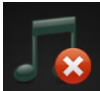

No.	Description	
①	Thumbnails	
	Abnormal file	
	File not supported	
②	File List	
③	Moves to the upper level folder.	
④	Current page/Total no. of folder pages	
⑤	Displays the remaining battery life.	
⑥	Current page/Total no. of file pages	
⑦	Moves to the top level folder.	
⑧	Moves to the upper level folder.	
⑨	Exits Music List.	

5 Control playback by using the following buttons.

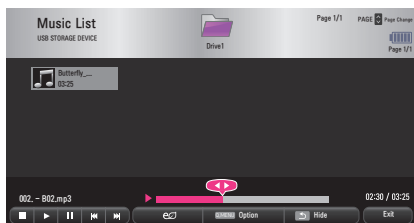

Item	Description
	Changes the playing position.
	Stops playing.
	Returns to normal playback.
	Pauses the media player.
	Plays the previous/next file.
	Reduces power consumption by adjusting peak screen brightness. (If the screen shows a low battery message, Energy Saving will be changed Maximum mode and will be disabled)
Option	Sets up the options of Music List.
Hide	Hides the playback bar. <ul style="list-style-type: none"> Press the OK button to make the playback bar appear.
Exit	Returns to the Music List screen.

Options for Music List

- 1** Press the **Q.MENU** button.
- 2** Use the **^** or **v** button to move to a desired option and press the **OK**  button.
- 3** Use the **^**, **v**, **<**, or **>** button to set up each item.

Set Audio Play.

Item	Description
Repeat	Selects repeat play.
Random	Selects random play.

Set Audio.

You can change audio settings. (Refer to *AUDIO Settings* on page 83.)

BLUETOOTH

You can change Bluetooth settings. (Refer to *Setting Up Bluetooth on the Projector* on page 40.)

Viewing Files

You can see document files stored on a connected device.

Supported File Formats

XLS, XLSX, DOC, DOCX, PPT, PPTX, TXT, PDF, HWP

Microsoft Office: 97/2000/2002/2003/2007 Version

Adobe PDF: 1.0/1.1/1.2/1.3/1.4 Version

Hangul: 97/2000/2002/2005/2007 Version

- File Viewer realigns a document, so it may look different from what is displayed on a PC.
- For documents that include images, the resolution may look lower during the realigning process.
- If the document is large or has many pages, it may take longer to load.
- Unsupported fonts may be replaced by other fonts.
- The file viewer may not open for Office documents that contain many high resolution images. In that case, reduce the image file size, save it on a USB storage device and run the file viewer again or connect your PC to the projector and open the file on your PC.

Browsing File List

- 1 Connect a USB storage device.
- 2 Press the **USB/MY MEDIA** button.
- 3 Use the **<** or **>** button to select **File List** and press the **OK** button.
- 4 Use the **^**, **v**, **<**, or **>** button to select the file you want and press the **OK** button.

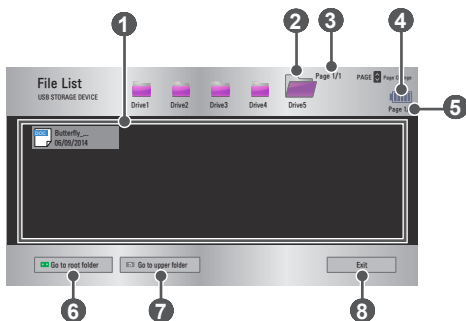

No.	Description
1	File List
2	Moves to the upper level folder.
3	Current page/Total no. of folder pages
4	Displays the remaining battery life.
5	Current page/Total no. of file pages
6	Moves to the top level folder.
7	Moves to the upper level folder.
8	Exits File List.

5 Control playback by using the following buttons.

- Click **Go Page**, then the pop-up window for selecting the number of page appears. Input the page to move to the page you want.
- Press the **VOL** \wedge , \vee button to zoom in or zoom out.

Press the **OK** \odot button and then use the **Up/Down/Left/Right** buttons to move to **Go Page** or **Zoom**.

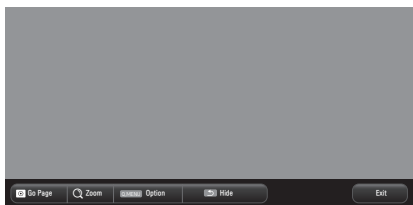

Item	Description
Go Page	Moves to the page you want. Use the Up/Down/Left/Right buttons to select a page and press the OK \odot button.
Zoom	Enlarges or reduces the document.
Option	Sets up the options of File Viewer.
Hide	Hides the menu. <ul style="list-style-type: none"> • Press the OK \odot button to make it appear.
Exit	Returns to the File Viewer screen.

Options for File List

- 1 Press the Q.MENU button.
- 2 Use the \wedge , \vee , \lt , or \gt button to set up each item.

Set FileViewer Option

Item	Description	
Single Page Loading	On	Loads and displays pages one by one. The initial loading time is short but a content-heavy page may be displayed slowly.
	Off	Loads all pages of a file to memory before it starts to display them. The initial loading time is long but you can navigate pages quickly after loading is complete. If a file is too large, it may fail to load all the pages.
Image Quality	You can set the quality of the image included in the document. The following three options are available for the image quality: High, Medium, Low. Higher the image quality, lower the display time.	
Document Align	Selects initial document align method.	

File Viewer settings are default, so close the currently opened document to apply changes to the new document, if any.

3D FUNCTION

3D technology uses different video frames for each eye to add depth to the video.

While Watching 3D

WARNING

- If you view 3D video or images too closely for a long period of time, you may experience eyestrain.
- If you watch the projector or game screen for a long time with 3D glasses on, you may experience dizziness or eye fatigue.
- People with chronic diseases (epilepsy, cardiovascular disease, blood pressure-related diseases, etc.), pregnant women, and people with serious motion sickness should avoid watching 3D video.
- People with stereo blindness, or with stereopsis problems, should also avoid watching 3D video content. It may cause double vision or visual discomfort.
- People with strabismus, amblyopia, or astigmatism may have difficulty perceiving video depth and may be fatigued easily due to double vision or other ailments. It is recommended to rest more frequently than other viewers.
- Because 3D can be perceived as real, some viewers may be surprised or overexcited.
- Do not watch 3D images near fragile objects or any objects that can be knocked over easily.
- Take care not to injure yourself as you may subconsciously try to move away from the life-like 3D images.

- **Warning about photosensitivity seizures**
 - Some users may experience a seizure or other abnormal symptoms when they are exposed to a flashing light or particular patterns from a video game. If anyone in your family has a history of epilepsy or has ever experienced any kind of seizure, please consult your doctor before viewing 3D images.
If you experience one of the following symptoms while watching a 3D video, stop watching the 3D video immediately and take a rest.
 - Dizziness, switched eyesight, twitching of the eye or facial muscles, involuntary movements, cramp, loss of consciousness, confusion, loss of sense of direction, or nausea. If the symptom does not disappear, please consult your doctor.
- You can reduce the risk of photosensitive seizures by taking the following preventive measures.
 - Take a rest of 5 to 15 mins. for every 1 hour of viewing.
 - If vision varies between each eye, correct the variation before beginning to watch a 3D video.
 - Ensure that the 3D video is directly in front of you, at eye level.
 - You should stop watching if you experience a headache, fatigue, or dizziness.
 - Do not view 3D images for a long period of time when you are tired or ill.

CAUTION

- Extra special care is required for children watching a 3D video.

When Watching 3D Video

- Prevent children of 5 years or younger from watching a 3D video. It may impair the development of their eyes.
- Children 10 years old or younger are still developing their eyesight and may have an excessive tendency to touch or jump at the screen. Adult guidance and supervision is recommended.
- Since the distance between the eyes is narrower for children than in adults, children tend to notice a greater difference in the images seen by each eye. Therefore, even while watching the same 3D video, children may have a greater depth perception than adults.
- Children under 19 years old or younger may respond with sensitivity to the light stimuli of 3D content. Excessive viewing when fatigued is not recommended.

- Elderly viewers may have a reduced depth perception than younger viewers. Avoid watching video nearer than the recommended distance.
- Watch 3D images within the optimum viewing angle and distance.
- If you are outside the viewing angle or distance, you may not be able to see 3D images. You cannot view 3D images when you are lying down.
- You may see left and right images overlapped during projector initialization after it is powered on. It may take some time for optimization.
- It may take some time for the 3D image to look normal after you turn your eyes away from the screen and look back at the 3D image.
- It may flicker slightly while watching 3D images under a 3 wavelength lamp fluorescent light (50 Hz to 60 Hz) or near windows. If so, it is recommended to block the sun light with a curtain and to dim the lights.
- The 3D glasses must be DLP-LINK (DLP Ready) type.
- You may not be able to watch 3D properly if there is an obstacle between the projector and 3D glasses.
- Install the 3D projector as far as possible from other devices.
- If a future 3D broadcasting format that is not supported by this projector becomes the standard, an additional device such as a set-top box may be required.

Please check the following when using 3D glasses.

- Do not use 3D glasses as ordinary glasses, sunglasses, or protective goggles.
 - If you do so, this may cause injury.
- Do not store 3D glasses in very hot or very cold conditions. If you do, this may cause them to become distorted. Do not use distorted glasses.
- Do not drop 3D glasses or allow them to come into contact with other objects.
 - This may cause product malfunction.
- The lenses of 3D glasses are easily scratched. Use a soft clean cloth when cleaning them.
- Foreign particles on the cloth may cause scratches.
- Do not scratch the surface of the 3D glasses' lenses with sharp objects or wipe them with chemicals. If the lenses get scratched, images may not look normal when viewing 3D.

Requirements for Watching 3D Images

- * Optimum viewing angle: Top/Bottom/Left/Right 9°
- Recommended viewing distance: 3 m to 5 m (with Adaptor)
1 m to 2 m (without Adaptor)
- Recommended screen size: 101 cm

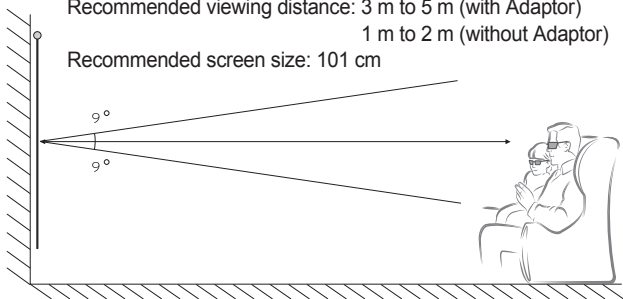

- * Watching 3D videos should be done in dark room environments only.



NOTE

- The pairing with the DLP-LINK glasses is affected by the intensity of light reflected from the screen. Therefore, the pairing with DLP-LINK glasses may not work properly if the light reflected from the screen is not bright enough, such as when the surrounding area is bright, the screen is big, or the maximum energy saving mode is enabled.
- Some menus may not work while playing a 3D video.
- You can only watch a 3D video properly when the 3D video format option has been selected on the projector.

Using the DLP-LINK (DLP-Ready) Type Glasses

- 1 While watching 3D images from the projector, press buttons on the glasses.
- 2 When you press the button, the glasses flicker while synchronizing with the 3D images. (The flickering is a unique operation method of DLP-LINK type glasses. It may be different depending on the glasses type.)
- 3 If the glasses flicker or problems occur while watching 3D, first turn the lights off to make the room darker. Contact your projector seller for queries about the glasses.

To view 3D images

3D imaging is a technology that utilizes the slight difference in left/right eyes to make the images on the projector appear just like real-life 3-dimensional space.

- 1 Play supported 3D video titles.
- 2 Press the **3D** button to activate 3D.
- 3 Turn on the 3D glasses and put them on.
- 4 While viewing 3D images, press the **3D** button on the remote control to end 3D image viewing.
- 5 Press the **L/R** button to switch the playing direction of an image. Select a screen with better 3D display quality.
 - If you press the **3D** button during viewing, it returns to 2D.

* Depending on the input signal, the available 3D type may differ.

Supported 3D Mode

	Signal	Resolution	Horizontal Frequency (kHz)	Vertical Frequency (Hz)	Supported 3D Formats
HDMI	720p	1280 x 720	89.9 / 90	59.94 / 60	Frame Packing
			75	50	Frame Packing
			45	60	Side by side (half), Top and Bottom
			37.5	50	Side by side (half), Top and Bottom
	1080i	1920 x 1080	33.7	60	Side by side (half), Top and Bottom
			28.125	50	Side by side (half), Top and Bottom
	1080p	1920 x 1080	53.95 / 54	23.98 / 24	Frame Packing
			67.5	60	Side by side (half), Top and Bottom, Single Frame Sequential
			27	24	Side by side (half), Top and Bottom
			33.7	30	Side by side (half), Top and Bottom
			56.25	50	Side by side (half), Top and Bottom, Single Frame Sequential

	Signal	Resolution	Horizontal Frequency (kHz)	Vertical Frequency (Hz)	Supported 3D Formats
USB	1080p	1920 x 1080	33.75	30	Side by side, Top and Bottom, MPO, JPS (Photo)

CUSTOMIZING SETTINGS

SETTINGS

- 1** Press the **SETTINGS** button.
- 2** Use the \wedge , \vee , \lt , or \gt button to select the desired item and press the **OK** \odot button.
- 3** Use the \wedge , \vee , \lt , or \gt button to set up the desired item and press the **OK** \odot button.
- 4** Press the **EXIT** button when completed.

Menu	Description
PICTURE	Adjusts the image quality for optimal viewing.
AUDIO	Adjusts the sound quality and volume level.
TIME	Sets time-related settings.
WIRELESS	Wireless-related features.
OPTION 1	Customizes the general settings.
OPTION 2	Customizes the settings related the projector.
INPUT	Selects the desired input source.
MY MEDIA	Accesses photo, music, movie, and document files.

PICTURE Settings

- 1 Press the **SETTINGS** button.
- 2 Use the **^**, **v**, **<**, or **>** buttons to select **PICTURE** and press the **OK** button.
- 3 Use the **^**, **v**, **<**, or **>** button to set up the desired item and press the **OK** button.
 - To return to the previous menu, press the **↶** button.
- 4 Press the **EXIT** button when completed.



The available picture settings are described as follows.

Menu	Description	
Energy Saving	Reduces power consumption by adjusting peak screen brightness. (If the screen shows a low battery message, Energy Saving will be changed Maximum mode and will be disabled)	
	Mode	
	Minimum/ Medium/ Maximum	Applies the pre-set Energy Saving mode.

Menu	Description	
Picture Mode	<p>Selects the picture mode optimized for the viewing environment or the program.</p> <p>You can also customize advanced options for each mode.</p>	
	Mode	
	Vivid	<p>Maximizes the visual effect of video. Heightens contrast, brightness, and sharpness to display vivid images.</p>
	Standard	<p>Displays images in standard levels of contrast, brightness, and sharpness.</p>
	Cinema	<p>Optimizes the image for a movie.</p>
	Sport	<p>Optimizes the image for sports by emphasizing primary colors and dynamic actions.</p>
	Game	<p>Optimizes the image for playing games on fast-moving screens.</p>
Expert1 / Expert2	<p>Menu for adjusting picture quality that allows experts and amateurs to enjoy the best projector viewing.</p> <ul style="list-style-type: none"> – Expert mode is for picture tuning professionals to control and fine-tune using a specific image. For normal images, the effects may not be dramatic. 	
Contrast	<p>Adjusts the difference between bright and dark regions of the screen.</p>	
Brightness	<p>Adjusts the overall screen brightness.</p>	
Sharpness	<p>Adjusts the sharpness of the borders between bright and dark. Horizontal and Vertical Sharpness are available only in Expert1 / Expert2.</p>	
Color	<p>Adjusts the intensity of all colors.</p>	
Tint	<p>Adjusts the balance between red and green levels.</p>	

Menu	Description
Advanced Control	Customizes the advanced settings.
Picture Option	Sets optional settings.
Picture Reset	Resets values customized by the user. Each picture mode is reset. Select the picture mode you wish to reset.
Aspect Ratio	Resizes the picture.

Advanced Control

Menu	Description
Dynamic Contrast	Adjusts contrast and color to the optimal level according to the screen's brightness.
Dynamic Color	Adjusts colors for more natural-looking colors.
Color Gamut	Selects the range of colors that can be expressed. <ul style="list-style-type: none"> • Standard: Displays the original colors of an input signal regardless of the display features. • Wide: Makes use of the display's rich colors.
Skin Color	Skin color spectrum can be separately set to implement the skin color as defined by the user.
Sky Color	Sky color is set separately.
Grass Color	Natural color spectrum (meadows, hills, etc.) can be separately set.
Gamma	Sets the gradation curve according to the output of the picture signal in relation to the input signal.

* Depending on input signal or other picture settings, the range of detailed items for adjustment may differ.

Expert Control

Menu	Description
Dynamic Contrast	Adjusts contrast and color to the optimal level according to the screen's brightness.
Color Gamut	<p>Selects the range of colors that can be expressed.</p> <ul style="list-style-type: none"> • Standard: Displays the original colors of an input signal regardless of the display features. • Wide: Makes use of the display's rich colors.
Edge Enhancer	Shows clearer and distinctive yet natural edges of the video.
Color Filter	Filters a specific color spectrum in RGB colors to fine-tune color saturation and hue accurately.
Color Temperature	<p>In Expert mode, you can customize the options of each mode.</p> <p>Gamma: Select 1.9, 2.2, or 2.4.</p> <p>a. Method: 2 Points</p> <ul style="list-style-type: none"> – Pattern: Inner, Outer – Points: Low, High – Red/Green/Blue: The adjustment range for each color is from -50 to +50. – Apply to all inputs: The values of the Color Temperature is applied to all the input modes. <p>b. Method: 20 Point IRE</p> <ul style="list-style-type: none"> – Pattern: Inner, Outer – IRE (Institute of Radio Engineers) is the unit indicating the size of a video signal and can be set to 5, 10, 15, ... 100. You can fine-tune for each setting as shown below. – Luminance: The adjustment range is 50 to 500. – Red/Green/Blue: The adjustment range is -50 to +50. – Apply to all inputs: The values of the Color Temperature is applied to all the input modes.

Menu	Description
Color Management System	<p>Adjusts Red/Green/Blue/Cyan/Magenta/Yellow colors. Allows an expert to adjust the tint using a test pattern. Six colors (Red/Green/Blue/Cyan/Magenta/Yellow) can be selectively adjusted without affecting other colors. You may not see colors change on a normal picture even after adjustment.</p> <ul style="list-style-type: none"> – Saturation Red/Green/Blue/Cyan/Magenta/Yellow, Tint Red/Green/Blue/Cyan/Magenta/Yellow, Luminance Red/Green/Blue/Cyan/Magenta/Yellow: <p>The adjustment range is -30 to +30 each.</p>

* Depending on input signal or other picture settings, the range of detailed items for adjustment may differ.

Picture Option

Menu	Description
Noise Reduction	Reduces screen noise in the video.
MPEG Noise Reduction	Eliminates noise generated while creating digital picture signals.
Black Level	Adjusts the brightness or darkness of the screen to suit the black level of the picture input using the degree of darkness (black level) of the screen.
Real Cinema	Optimizes the screen for movie viewing.
Color Temperature	Adjusts the overall color of the screen to suit your preference. Select Warm , Natural , Cool , or Medium .

AUDIO Settings

- 1 Press the **SETTINGS** button.
- 2 Use the **^**, **v**, **<**, or **>** button to select **AUDIO** and press the **OK** button.
- 3 Use the **^**, **v**, **<**, or **>** button to set up the desired item and press the **OK** button.
 - To return to the previous menu, press the **↶** button.
- 4 Press the **EXIT** button when completed.

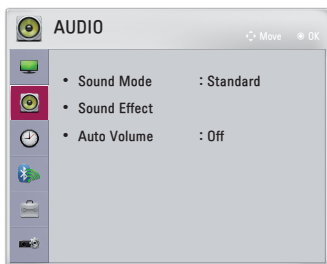

The available audio settings are described as follows.

Menu	Description	
Sound Mode	Sets the sound mode.	
	Mode	
	Standard	Suitable for all types of video.
	News/Music/ Cinema/ Sport/Game	Sets audio optimized for a specific genre.

Menu	Description	
Sound Effect	The user can select various sound effects.	
	Mode	
	Clear Voice II	Makes the voice from the projector crisp and clear.
	Virtual Surround	LG's proprietary audio processing technology allows 5 channel-like surround sound from two speakers. <ul style="list-style-type: none"> • When Clear Voice II is set to on, Virtual Surround cannot be selected.
	Equalizer	Adjusts the volume to a level of your choice using the Equalizer. <ul style="list-style-type: none"> • Audio-band (100 Hz/ 300 Hz/ 1 kHz/ 3 kHz/ 10 kHz) can be adjusted from -10 to 10. • Reset: Resets voice options that the user has changed.
	Balance	Adjusts the balance of the left and right speakers.
Reset	Initialize the applied effect under the Sound Effect menu.	
Auto Volume	Automatically adjusts the volume level.	

TIME Settings

- 1 Press the **SETTINGS** button.
- 2 Use the **^**, **v**, **<**, or **>** button to select **TIME** and press the **OK** button.
- 3 Use the **^**, **v**, **<**, or **>** button to set up the desired item and press the **OK** button.
 - To return to the previous menu, press the **↶** button.
- 4 Press the **EXIT** button when completed.

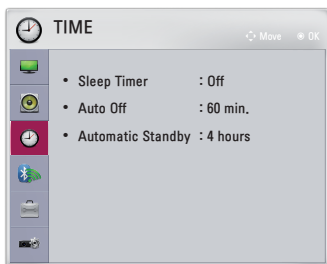

The available time settings are described as follows.

Menu	Description
Sleep Timer	Turns off the projector after a preset number of minutes. To cancel the Sleep Timer , select Off .
Auto Off	If there is no input signal or button press, the projector automatically turns off after the preset time has elapsed.
Automatic Standby	Turns off the projector automatically after a set period of time if there is no button input on the projector.

WIRELESS Settings

- 1 Press the **SETTINGS** button.
- 2 Use the **^**, **v**, **<**, or **>** button to select **WIRELESS** and press the **OK** button.
- 3 Use the **^**, **v**, **<**, or **>** button to set up the desired item and press the **OK** button.
 - To return to the previous menu, press the **↶** button.
- 4 Press the **EXIT** button when completed.



The available wireless settings are described as follows.

Menu	Description	
SCREEN SHARE	The SCREEN SHARE displays the screen of the connected device. <ul style="list-style-type: none"> • You can check the SCREEN SHARE's ID. 	
	Mode	
	Group	This is the group setting for each device supporting the SCREEN SHARE feature. When the wireless connection is weak or unstable, adjust the group setting to correct the problem.
	Channel	<p>You can change the channel used for wireless connections.</p> <ul style="list-style-type: none"> • Search Channels: Select channel searching methods. <ul style="list-style-type: none"> – Auto: The projector searches for available channels and automatically selects the least used channel. – Manual: You can select a channel manually. • Channel: This is shown when Search Channels is set to Manual. It allows you to specify a channel number to use.

Menu	Description	
Bluetooth	Sound is output through the Bluetooth headset. First, set Bluetooth to On.	
	Item	
	Search Device	Search for the device to connect to.
	List of registered devices	Connected devices are saved in the List of registered devices . The saved list of registered devices can be displayed.
AV Sync. Adjust	When the video and the sound are not synchronized correctly, you can manually adjust the synchronization.	

OPTION 1 Settings

- 1 Press the **SETTINGS** button.
- 2 Use the **^**, **v**, **<**, or **>** button to select **OPTION 1** and press the **OK** button.
- 3 Use the **^**, **v**, **<**, or **>** button to set up the desired item and press the **OK** button.
 - To return to the previous menu, press the **↶** button.
- 4 Press the **EXIT** button when completed.



The available option 1 settings are described as follows.

Menu	Description
Language	Selects a desired Menu Language.
3D Mode	Adjusts various aspects of 3D imaging.
	Mode
3D Picture Correction	Switches left/right images of 3D video.
DivX(R) VOD	Sets DivX related settings.
Initial Setting	Resets all the projector settings to the factory default. Do not turn off the power during initialization.
Mode Setting	Selects Standard or Store Demo . When in use in home, please select Standard . Store Demo mode is for store display.

OPTION 2 Settings

- 1 Press the **SETTINGS** button.
- 2 Use the \wedge , \vee , \lt , or \gt button to select **OPTION 2** and press the **OK** button.
- 3 Use the \wedge , \vee , \lt , or \gt button to set up the desired item and press the **OK** button.
 - To return to the previous menu, press the **RETURN** button.
- 4 Press the **EXIT** button when completed.

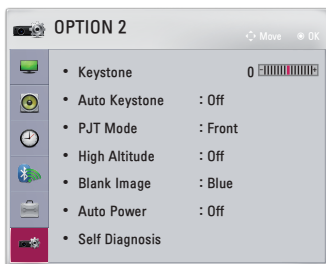

The settings for option 2 are described as follows.

Menu	Description			
Keystone	To prevent the screen image from becoming trapezoidal, Keystone adjusts the top and bottom width of the image if the projector is not set at a right angle to the screen.			
Auto Keystone	Auto Keystone provides a rectangular screen image by automatically adjusting the Keystone number when there is a trapezoidal screen image caused by tilting of the projector.			
	Item			
	<table border="1"> <tr> <td>On</td> <td>Automatically adjusts the Keystone number.</td> </tr> <tr> <td>Off</td> <td>Manually adjusts the Keystone number.</td> </tr> </table>	On	Automatically adjusts the Keystone number.	Off
On	Automatically adjusts the Keystone number.			
Off	Manually adjusts the Keystone number.			
PJT Mode	<p>This function turns the projected image upside down or flips horizontal.</p> <ul style="list-style-type: none"> • Select Rear when projecting from the back of the transparent screen purchased separately. • Select Front Ceiling when installing the product on the ceiling. • When the PJT Mode is Rear Ceiling/Front Ceiling, the left/right of the speaker changes automatically. 			

Menu	Description	
High Altitude	<p>If the projector is used at an altitude higher than 1200 meters, turn this on.</p> <p>Otherwise, the projector may overheat or its protection function may be activated. If this happens, turn the projector off and then on again after waiting for several minutes.</p>	
Blank Image	Selects a background for blank image.	
Auto Power	Makes the projector turn on automatically when the adaptor plug is inserted.	
	Item	
	On	When the AC/DC plug is connected to the projector, it turns on automatically.
Off	When the AC/DC plug is connected to the projector, it goes into standby mode.	
Self Diagnosis	Troubleshoots functional problems that can arise while using the product.	

CONNECTING DEVICES

You can connect various external devices to the projector.

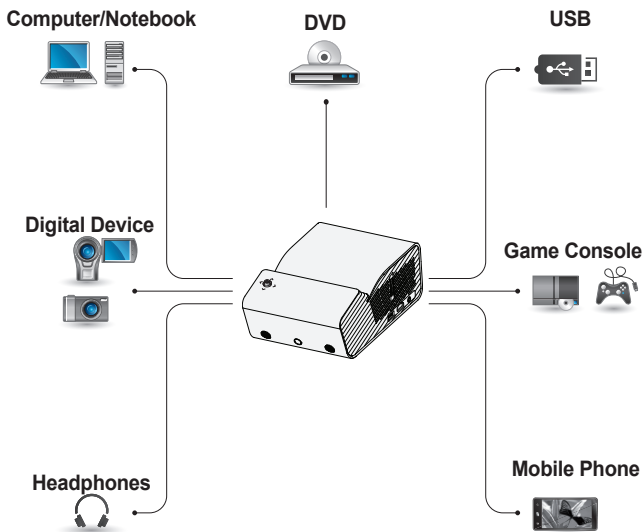

HDMI - Page 92

USB Device - Page 45

Headphone - Page 94

Mobile Phone (MHL/Slimport) - Page 95

Connecting to HD Receiver, DVD Player, or External Devices

Connect an HD receiver, DVD player, or External Devices to the projector and select an appropriate input mode.

HDMI Connection

With an HDMI cable, you can enjoy high quality picture and sound.

Using a HDMI cable, connect the **HDMI MHL** port of the projector to the HDMI output port of the device to connect. Both video and audio are output at the same time.

Press the **INPUT** button on the remote control to select **HDMI**.

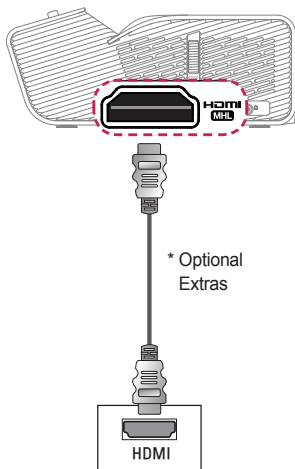

Connecting a PC

The projector supports Plug and Play. Your PC will automatically detect the projector and requires no driver installation.

HDMI Connection

Using an HDMI cable, connect the **HDMI MHL** port of the projector to the HDMI output port of your PC. Both video and audio are output at the same time.

Press the **INPUT** button on the remote control to select **HDMI**.

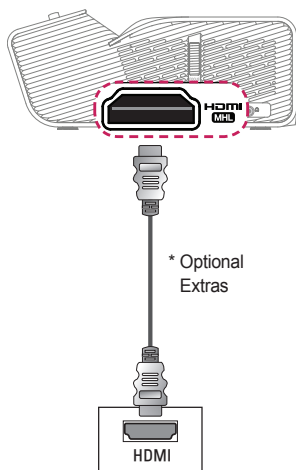

Connecting a Laptop

You can connect the projector to a laptop to use various functions.

HDMI Connection

Using an HDMI cable, connect the **HDMI MHL** port of the projector to the HDMI output port of your laptop. Both video and audio are output at the same time.

Press the  **INPUT** button on the remote control to select **HDMI**.

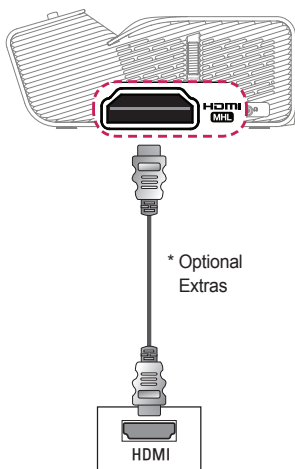

The table below shows examples of switching the output. For more information, refer to the **External Output, Connecting to an External Monitor**, or similar sections of the owner's manual of your computer.

Brand	Switching Output
NEC	Fn + F3
Panasonic	Fn + F3
Toshiba	Fn + F5
IBM	Fn + F7
Sony	Fn + F7
Fujitsu	Fn + F10
LG	Fn + F7
Samsung	Fn + F4
Macintosh	Adjust the control panel to enable mirroring after start-up.

Connecting to Headphones

You can listen to the audio through a headphone.

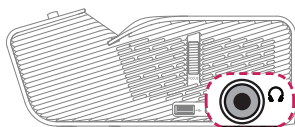

* Not
provided

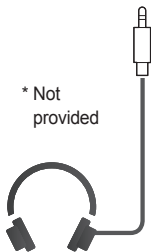

Using the Mirroring Function of a Mobile Phone

MHL/Slimport Connection

You must use a HDMI adapter to connect your cell phone to the projector and to output images and sound from your cell phone to the projector. The compatible HDMI adapters are different, depending upon your cell phone type.

Therefore, purchase an appropriate MHL or Slimport adapter.

(To find out whether your device is MHL/Slimport-certified, please contact your device manufacturer.)

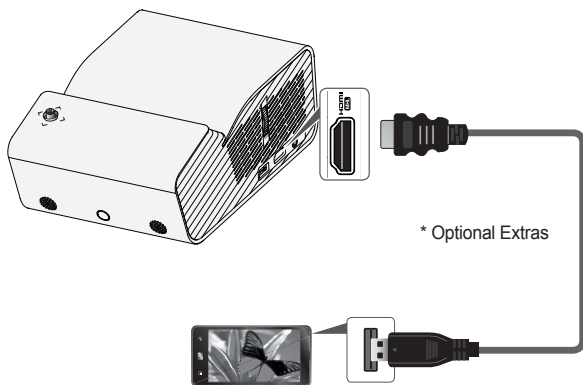

NOTE

- When you connect a mobile phone to the **HDMI MHL** port, you can see the mobile phone screen through a projector.
 - This only applies to mobile phones that support MHL/Slimport.
 - You can use the remote control for some applications.
- Disconnect the MHL/Slimport cable from the projector when:
 - The MHL/Slimport function is disabled.
 - Your mobile device is fully charged in standby mode.

MAINTENANCE

Clean your projector to keep it in optimal condition.

Cleaning

Cleaning the Lens

If there is any dust or staining on the lens surface, you must clean the lens. Use an air spray or a cleaning cloth to clean the lens.

To remove dust or stains, use an air spray or apply a small amount of cleaning agent onto a swab or soft cloth to lightly rub the lens.

Please be aware that liquid may flow into the lens if the product is sprayed directly onto the lens.

Cleaning the Projector Case

To clean the projector case, first unplug the power cord.

To remove dust or stains, use only a dry, lint-free, nonabrasive cloth to polish the lens.

Do not use alcohol, benzene, thinners, or other chemicals, which may damage the case.

SPECIFICATIONS

MODEL	PH450UG (PH450UG-GL)	
Resolution (Pixel)	1280 (Horizontal) × 720 (Vertical)	
Aspect ratio	16:9 (Horizontal:Vertical)	
Panel size	7.93 mm	
Projection distance (Screen Size)	274 mm to 531 mm (1016 mm to 2032 mm)	
Ratio of upward projection	120 %	
Working range of the remote control	6 m	
Power consumption	55 W	
AC-DC Adaptor	19 V  2.53 A (Adaptor Input 100-240 V @ 50/60 Hz)	
Audio Output	1 W + 1 W	
Height	80.5 mm (without foot), 85 mm (with foot)	
Width	132 mm	
Depth	200 mm	
Weight	1100 g	
USB Device	5 V, 0.5 A (Max.)	
Environment Condition	Temperature	
	Operation	0 °C to 40 °C
	Storage	-20 °C to 60 °C
	Relative Humidity	
	Operation	0 % to 80 %
	Storage	0 % to 85 %

* Use only power supplies listed in the user instructions.

* Contents in this manual may be changed without prior notice due to upgrade of product functions.

Supported HDMI(PC) Mode

Resolution	Horizontal Frequency (kHz)	Vertical Frequency (Hz)
640 x 350	31.468	70.09
720 x 400	31.469	70.08
640 x 480	31.469	59.94
800 x 600	37.879	60.31
1024 x 768	48.363	60.00
1152 x 864	54.348	60.053
1280 x 720	45.00	60.00
1280 x 1024	63.981	60.020
1440 x 900	55.935	59.888
1400 x 1050	65.317	59.979
1600 x 900	60	60
1680 x 1050	65.29	59.954
1920 x 1080	67.5	60

- If an invalid signal is input into the projector, it will not be displayed properly on the screen or a message such as **No Signal** or **Invalid Format** will be displayed.
- The projector supports the DDC1/2B type as the Plug and Play function (Auto-recognition of PC monitor).
- In PC mode, 1280 x 720 is recommended for the best picture quality.

Supported HDMI/DTV Mode

Resolution	Horizontal Frequency (kHz)	Vertical Frequency (Hz)
480p	31.47	60
	31.47	59.94
	31.50	60
576p	31.25	50
720p	45.00	60.00
	44.96	59.94
	37.5	50
1080i	33.75	60.00
	33.72	59.94
	28.125	50
1080p	67.500	60
	67.432	59.939
	27.000	24.000
	26.97	23.976
	33.75	30.000
	33.71	29.97
	56.25	50

- To provide the best picture quality, a 720p resolution is recommended.

Open source software notice information

To obtain the source code under GPL, LGPL, MPL, and other open source licenses, that is contained in this product, please visit <http://opensource.lge.com>.

In addition to the source code, all referred license terms, warranty disclaimers and copyright notices are available for download.

LG Electronics will also provide open source code to you on CD-ROM for a charge covering the cost of performing such distribution (such as the cost of media, shipping, and handling) upon email request to opensource@lge.com. This offer is valid for three (3) years from the date on which you purchased the product.

