

IN5552L, IN5554L, IN5555L, IN5852L, IN5854L, IN5855L

User's Guide
Mode d'emploi
Benutzeranleitung
Manuale d'uso
Manual de Uso
Guia do Usuário
Gebruikershandleiding

Användarhandbok
Brukerhåndbok
Руководство по пользователю
사용 설명서
用戶指南
Panduan Pengguna
دليل المستخدم

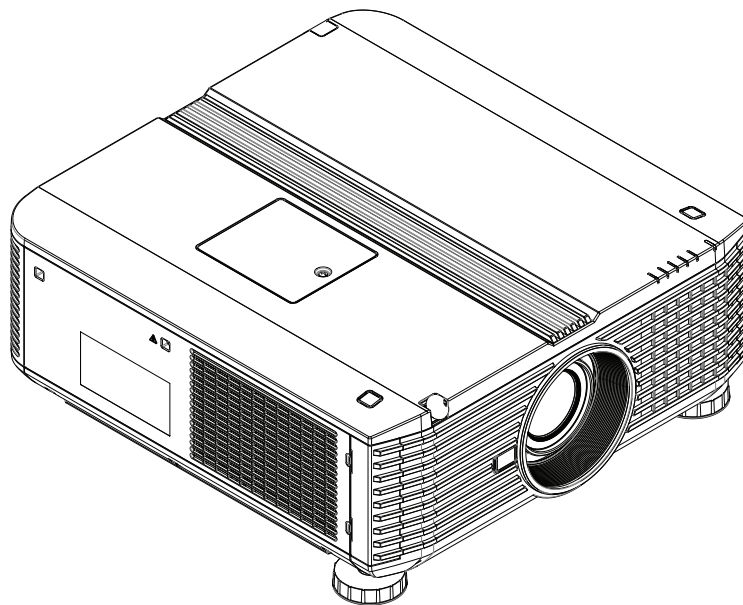

3534227501
DISPERINDAG No. 0287/1.824.51/09.03
Regulatory models: IN5552L, IN5554L, IN5555L, IN5852L, IN5854L, IN5855L

InFocus

Bright Ideas Made Brilliant

Declaration of Conformity

Manufacturer: InFocus Corporation, 13190 SW 68th Parkway, Portland, Oregon
97223-8368 USA

We declare under our sole responsibility that this projector conforms to the following directives and norms:

EMC Directive 2004/108/EC

ErP Directive 2009/125/EC

EMC: EN 55022: 2010

EN 55024: 2010

EN 61000-3-2: 2006+A2:2009

EN 61000-3-3:2008

Low Voltage Directive 2006/95/EC

Safety: IEC 60950-1:2005; EN 60950-1:2006+A12:2011

Trademarks

Apple, Macintosh, and PowerBook are trademarks or registered trademarks of Apple Computer, Inc. IBM is a trademark or registered trademark of International Business Machines, Inc. Microsoft, PowerPoint, and Windows are trademarks or registered trademarks of Microsoft Corporation. Adobe and Acrobat are trademarks or registered trademarks of Adobe Systems Incorporated. DLP® and the DLP logo are registered trademarks of Texas Instruments and BrilliantColor™ is a trademark of Texas Instruments. InFocus, In Focus, and INFOCUS (stylized) are either registered trademarks or trademarks of InFocus Corporation in the United States and other countries



NOTE: This product is covered electrical and electronic equipment under the European Union's Waste from Electrical and Electronic Equipment ("WEEE") Directive (2002/96/EC). The WEEE Directive requires that covered equipment be collected and managed separately from typical household waste in all EU member states. Please follow the guidance of your local environmental authority or ask the shop where you purchased the product for collection or recycling options.

FCC Warning

This device complies with part 15 of the FCC Rules. Operation is subject to the following two conditions: (1) This device may not cause harmful interference, and (2) this device must accept any interference received, including interference that may cause undesired operation.

Note: This equipment has been tested and found to comply with the limits for a Class B digital device, pursuant to part 15 of the FCC Rules. These limits are designed to provide reasonable protection against harmful interference in a residential installation. This equipment generates, uses and can radiate radio frequency energy and, if not installed and used in accordance with the instructions, may cause harmful interference to radio communications. However, there is no guarantee that interference will not occur in a particular installation. If this equipment does cause harmful interference to radio or television reception, which can be determined by turning the equipment off and on, the user is encouraged to try to correct the interference by one or more of the following measures:

--Reorient or relocate the receiving antenna.

--Increase the separation between the equipment and receiver.

--Connect the equipment into an outlet on a circuit different from that to which the receiver is connected.

--Consult the dealer or an experienced radio/TV technician for help.

Changes or modifications not expressly approved by InFocus Corporation may void authority to operate the equipment.

Canada

This Class B digital apparatus complies with Canadian ICES-003. Cet appareil numérique de la classe B est conforme à la norme NMB-003 du Canada.

Agency Approvals

UL, cUL, TUV-GS, SASO, SABS, KC, NOM, PCT, PSB, UL-S(Argentina), C-tick, FCC and CE

Other specific Country Approvals may apply. Please see product certification label.

This document applies to regulatory models IN5552L, IN5554L, IN5555L, IN5852L, IN5854L, and IN5855L.

Input ratings: AC 110-240V, 9-4A, 50-60Hz

InFocus reserves the right to alter product offerings and specifications at any time without notice.

Table of Contents

Introduction	4
Positioning the projector	6
Ceiling Mount	7
Connecting power	8
Connecting a computer source	8
Displaying an image	9
Adjusting the image	10
Connecting a video device	11
Video device connections	11
Shutting down the projector	12
Troubleshooting your setup	12
Using the remote control	20
Using the keypad buttons	22
Using the menus	23
Input menu	24
Picture menu	25
Lamps menu	26
Alignment menu	27
Control menu	28
Service menu	29
Using Projector Web Controls	30
Maintenance	34
Cleaning the lens	34
Replacing the projection lamps	34
Replacing the lens	36
Replacing the filters	37
Changing the color wheel	38
Using the security lock	39
Appendix	40
Optional Lenses	40
PiP Compatibility	46
RS-232 commands	47
Index	54

Important Operating Considerations for Safety

- Refer to this guide for proper startup and shutdown procedures.
- Follow all warnings and cautions in this manual and on the projector.
- Do not block the lens with any object while the projector is being used. Blocking the light path can cause overheating and result in fire.
- Place the projector in a horizontal position no greater than 8 degrees off axis.
- Locate the projector at least 4' (1.2m) away from any heating or cooling vents.
- Do not block ventilation openings. Locate the projector in a well-ventilated area without obstructions to intake or exhaust vents. Do not place the projector on a tablecloth or other soft covering that may block the vents.
- Do not place the projector in direct sunlight, humid, greasy or dusty places or in places where the projector may come into contact with smoke or steam.
- Do not look directly into the lens while the projector is being used.
- Do not drop the projector.
- Do not spill liquid on the projector. Spilled liquid may damage the projector.
- Use the power cord provided. Connect the power cord to a receptacle with a protective safety (earth) ground terminal. A surge-protected power strip is recommended.
- Do not overload wall outlets.
- When disconnecting the power cord, hold the plug, not the cord.
- Wash hands after handling the cables supplied with this product.
- The projector remote control uses batteries. Make sure the batteries' polarity (+/-) is aligned correctly. Dispose of used batteries in accordance with local disposal laws.
- Use an InFocus approved ceiling mount kit for proper fitting, ventilation and installation. The warranty does not cover any damage caused by use of non-approved ceiling mount kits or by installing in an improper location.
- When the projector is ceiling mounted, wear protective eyewear to prevent eye injury before opening lamp door.

- The projector must be installed by a qualified professional in order to ensure proper operation and reduce the risk of hazards or injury. It is not recommended you install the projector yourself.
- Refer all service to qualified service personnel. Servicing your own projector can be dangerous to you and will void the warranty.
- Only use replacement parts specified by InFocus. Unauthorized substitutions may result in fire, electrical shock, or injury, and may void the warranty.
- Only genuine InFocus lamps are tested for use in this projector. Use of non InFocus lamps may cause electrical shock and fire, and may void the projector warranty.
- Hg – Lamp contains mercury. Manage in accordance with local disposal laws. See www.lamprecycle.org.
- The projector uses a high-pressure mercury glass lamp. The lamp may fail prematurely, or it may rupture with a popping sound if jolted, scratched, or handled while hot. The risk of lamp failure or rupture also increases as the lamp age increases; please replace the lamp when the Lamp LED is red.
- In the unlikely event of a lamp rupture, particles may exit through the projector vents. Please keep people, food, and drinks out of the “keep out” area under and around the projector, as indicated by the illustration.

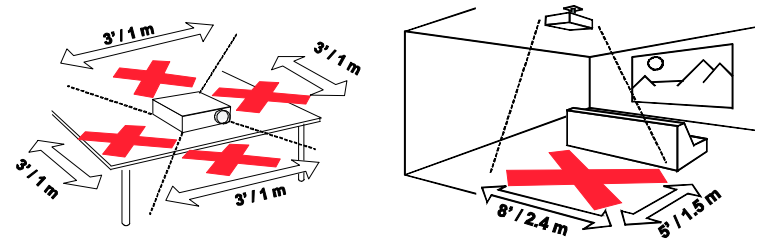

Follow these instructions to help ensure image quality and lamp life over the life of the projector. Failure to follow these instructions may affect the warranty. For complete details of the warranty, see the Safety/Warranty Booklet.

Introduction

Your new digital projector is simple to connect, easy to use, and straightforward to maintain. It is a versatile projector that is flexible enough to fit almost any installation scenario. The IN5552L and IN5852L have XGA 1024 x 768 resolution, the IN5554L and IN5854L have WXGA 1280x800 resolution, and the IN5555L and IN5855L have native WUXGA 1920x1200 resolution. This guide applies to all three products. They are compatible with a wide variety of computers and video devices. Note: These projectors do not ship with a lens. An optional lens must be chosen for the product.

Product Specifications

To read the latest specifications on your multimedia projector, be sure to visit our support website at www.infocus.com/support, as specifications are subject to change.

Online Registration

Register your projector on our website at www.infocus.com/register to activate your warranty and receive product updates, announcements, and registration incentives.

Included Items



Remote Control

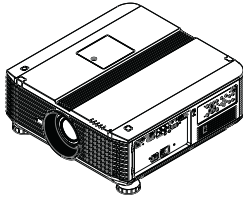

Projector



Dust Cap



Optional RGBCMY
Color Wheel



Power Cord



RGB (VGA) Cord

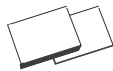

Documentation

Optional Accessories

Optional accessories include optional lenses and a ceiling mount. These items and other accessories can be found on our website at www.infocus.com or at your local dealer.

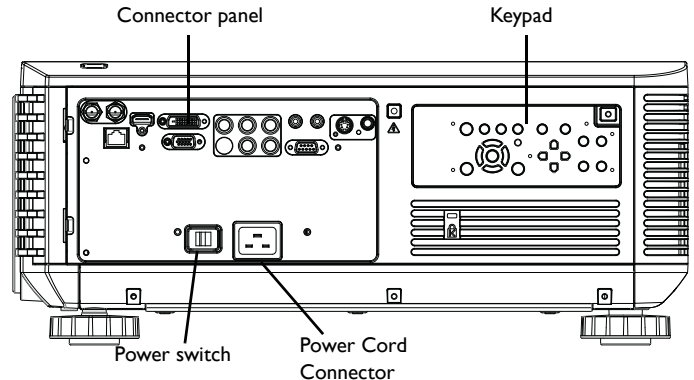
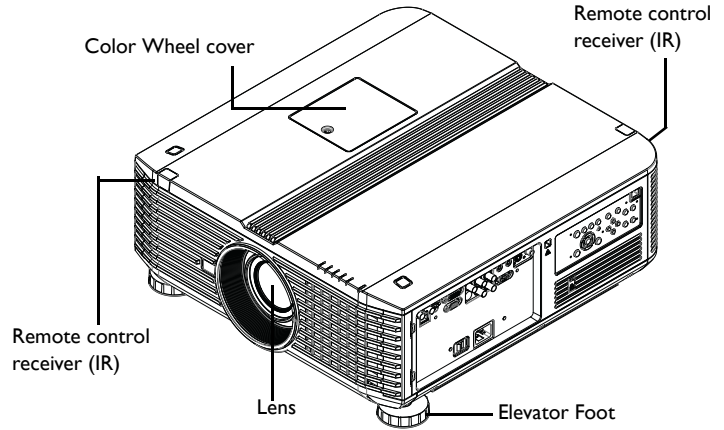

Connector Panel

The projector provides both computer and video connection options, including:

- HDMI
- DVI-D
- 3G-SDI
- BNC RGBHV and YPbPr for RGBHV, EDTV and HDTV
- RGB (VGA) computer
- S-video
- Composite video

The projector also provides the following connectors:

- LAN port for network control and web server.
- 12V screen trigger output
- Wired remote jack
- RS-232 connector for serial control. Command control codes are in the Appendix and on our support website at www.infocus.com/support.

12V Screen Trigger output

The 3.5mm mini-jack screen trigger provides a 12 volt, 0.25 amp DC output. It turns on when the lamp is lit. If you connect your projection screen to this output using the cable that came with your screen, the screen will move down when the lamp is turned on and return to its storage position when the lamp is turned off.

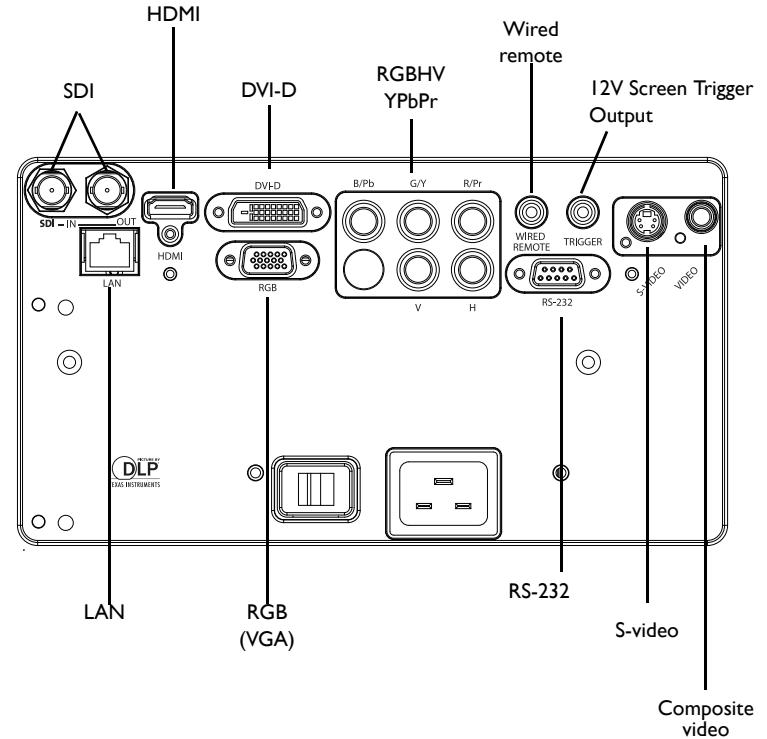

Positioning the Projector

To determine where to position the projector, consider the size and shape of your screen, the location of your power outlets, and the distance between the projector and the rest of your equipment. Here are some general guidelines:

- Position the projector on a flat surface at a right angle to the screen. The projector (with the standard zoom lens, LENS-074) must be at 55.8"/1.42m(XGA) ; 60.2"/1.53m (WXGA) ; 57.2"/1.45m (WUXGA) from the projection screen. See appendix for additional lens information.
- Position the projector within 10 feet (3m) of your power source and within 6 feet (1.8m) of your video device (unless you purchase extension cables). To ensure adequate cable access, do not place the projector within 6 inches (.15m) of a wall or other object.
- Position the projector to the desired distance from the screen. The distance from the lens of the projector to the screen, the zoom setting, and the video format determine the size of the projected image.
- The image exits at a given angle. However, the lens shift feature makes the image offset variable.
- The vertical image offset range for all the projectors is -60% to +20% (default 0%), and the horizontal image offset is +/-10% (default 0%). At 20% vertical offset, the bottom of the image is 20% of the image height above the center of the lens in a tabletop configuration.

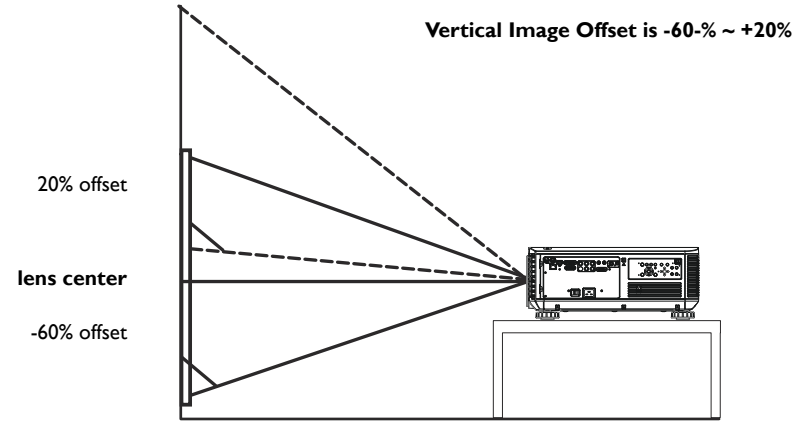

Horizontal Image Offset is +/-10%

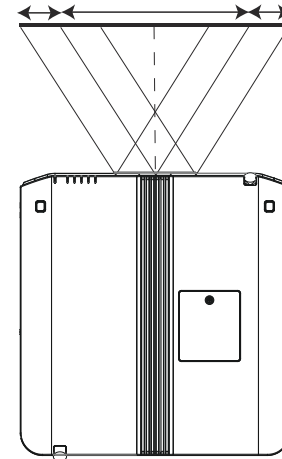

Ceiling Mount

If you wish to install the projector on the ceiling:

- The projector must be installed by a qualified professional in order to ensure proper operation and reduce the risk of hazards or injury. It is not recommended you install the projector yourself.
- We strongly recommend using InFocus approved ceiling mounts for proper fitting, ventilation and installation. Refer to the ceiling mount installation guide for more information. The warranty does not cover any damage caused by use of non-approved ceiling mount kits or by installing in an improper location.
- The ceiling must be strong enough to support the projector and the installation must be in accordance with any local building codes. Consult your dealer for more information.
- The maximum physical pitch is unlimited, however the lamp life will be negatively affected.
- The maximum supported physical horizontal roll is $\pm 10^\circ$. Note: Lamp life will be negatively affected.
- Keep all adjacent surfaces at least 19.7" (50cm) from the sides, 12" (30cm) from the top and bottom of the projector, and 27.6" (70cm) from the back of the projector to preserve required airflow around the projector.

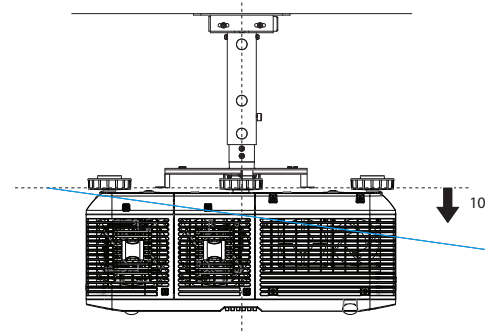

Connecting power

Connect the black power cord to the **Power** connector on the side of the projector and to your electrical outlet. Turn on the power switch. The Power LED on the top of the projector (page 12) turns red.

NOTES: Note: Connection to a circuit with a minimum of 20A capacity is recommended. Always use the power cord that shipped with the projector.

Connect power cord

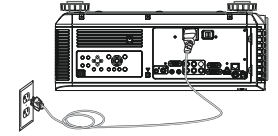

Connecting a computer source

HDMI 1.3 connection

Plug an HDMI cable into the video out connector on the video device and into the **HDMI** connector on the projector.

Connect HDMI cable

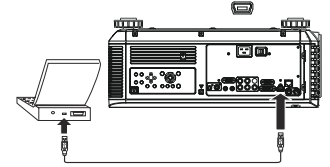

To take advantage of HDMI 1.3 Deep Color (30 bit) you must have a 1.3-compatible source.

DVI-D

Plug a DVI-D cable into the video out connector on the video device and into the **DVI** connector on the projector.

Connect DVI-D cable

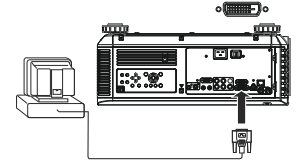

RGB (VGA) connection

Connect one end of the provided computer cable to the **RGB** connector on the projector and the other to the VGA connector on your computer. If you are using a desktop computer, you will need to disconnect the monitor cable from the computer's video port first.

Connect RGB (VGA) cable

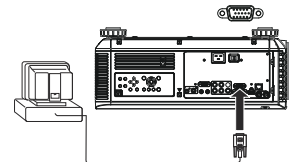

RGBHV connection

Connect one end of the BNC cable to the computer and the other end of the cable into the BNC connectors on the projector.

Connect RGBHV cable

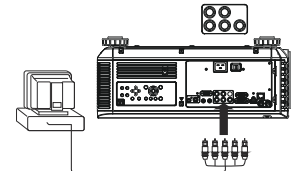

Note: This projector does not support audio. Audio must be routed separately.

Displaying an image

Touch the **Power** button on the keypad or the remote.

The Power button blinks green and the fans start to run. When the lamp turns on, the start up screen will display and the Power button will become solid green. It can take a minute for the image to achieve full brightness.

No start up screen? Get help on page 13.

Turn on your computer or video device.

The image should appear on the projection screen. If it doesn't, press the **Input** button on the projector's keypad or remote.

If you are using a laptop, make sure its external video port is active.

Many laptops do not automatically turn on their external video port when a projector is connected. Usually a key combination like Fn + F8 or CRT/LCD key turns the external display on and off. Locate a function key labeled CRT/LCD or a function key with a monitor symbol. Press **Fn** and the labeled function key simultaneously.

Refer to your laptop's documentation for more information about your laptop's key combination.

No laptop image? Try pressing the **Auto Sync** button on the keypad or remote. Get help on page 22.

Press Power button

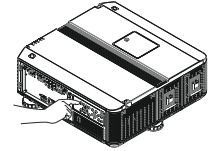

Turn on computer or video device

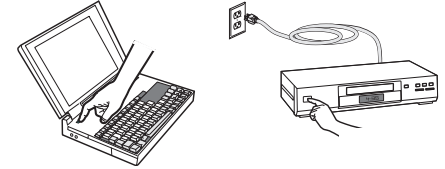

Activate laptop's external port



Monitor key or
LCD/CRT key

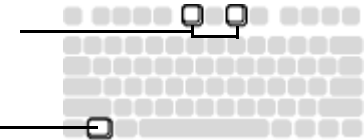

Adjusting the image

Position the projector to the desired distance from the screen at a 90 degree angle to the screen. See the Appendix for screen sizes and distances associated with the various lens options.

If the image is square but not centered on the screen or viewing area, adjust Zoom or Lens Shift using the keypad or remote. Focus can also be adjusted using the keypad or remote.

Rotate the elevator feet for adjustment of the projector's height. Avoid placing your hands near the hot exhaust vent at the back of the projector.

Adjust the Contrast or Brightness in the Picture menu. See page 25 for help with these menu adjustments.

Adjust distance

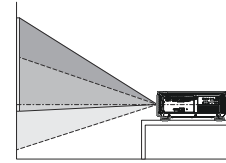

Adjust zoom, focus and lens shift.

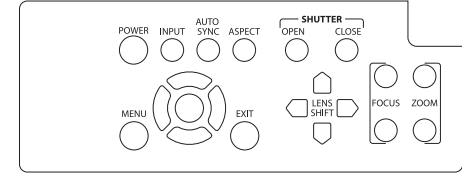

Adjust height

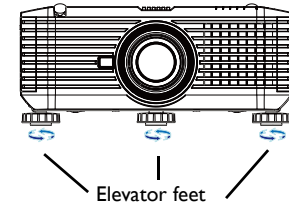

Adjust contrast and brightness.

INPUT	PICTURE	LAMPS	ALIGNMENT	CONTROL	SERVICE
Picture Mode	< High Bright >				
Contrast	< 100 >				
Brightness	< 100 >				
Adaptive Contrast	< Off >				
Saturation	< — >				
Hue	< — >				
Gamma	< Video >				
Color	< Enter >				
Sharpness	< 0 >				
Noise Reduction	< 0 >				
Aspect Ratio	< 16:10 >				
OverScan	< Off >				
VGA Setup	Enter				
Auto Sync	Execute				

Connecting a video device

You can connect video devices such as VCRs, DVD players, camcorders, digital cameras, video game consoles, HDTV receivers, and TV tuners to the projector.

Note: This projector does not support audio. You must connect audio directly from your source to a stereo or home theater system.

You can connect the projector to most video devices that can output video. You cannot directly connect the coaxial cable that enters your house from a cable or satellite company; the signal must pass through a tuner first. Examples of tuners are digital cable boxes, VCRs, digital video recorders, and satellite TV boxes. Basically, any device that can change channels is considered a tuner.

Although the aspect ratio is automatically selected by the projector based on the signal input, you can change the aspect ratio, if desired. The projector's Aspect Ratio setting is accessed through the Aspect button on the remote or through the projector's Picture Menu. See page 25 for more information.

Video device connections

No video cables are provided with the projector. You can order cables from InFocus or use your own.

HDMI 1.3 connection

HDMI is a standard, uncompressed, all-digital audio/video interface. HDMI provides an interface between sources, such as set-top boxes, DVD players, and receivers and your projector. Plug an HDMI cable into the video out connector on the video device and into the **HDMI** connector on the projector.

To take advantage of HDMI 1.3 Deep Color (30 bit) you must have a 1.3-compatible source.

G3-SDI

Connect a BNC coaxial cable into the video device. Plug the other end of the cable into the **SDI In** connector on the projector.

Component video connection

Plug a BNC type component cable into the video device. Plug the other end of the component cable into the YPbPr connectors as appropriate.

In addition, a Component to VGA adapter can be used in conjunction with the VGA connectors. Plug the component cable into the video device. Plug the other end of

the component cable into the adapter and plug the adapter into the RGB connector.

Component offers the highest quality analog video output.

S-video connection

If your video device uses a round, four-prong S-video connector, plug an S-video cable into the S-video connector on your video device and into the **S-video** connector on the projector.

S-video delivers higher quality video output than composite.

Composite video connection

Plug the composite video cable's yellow connector into the video out connector on the video device. Plug the other yellow connector into the yellow **Video connector** on the projector.

Composite Video output from composite connections is not as high quality as S-video or as Component.

RGB (VGA) connection

If your video device has a 15-pin VGA output, plug one end of the included computer cable into the VGA connector on your video source. Plug the computer cable into the **RGB** connector on the projector.

G3-SDI Out

Connect one end of a BNC coaxial cable into the **SDI Out** connector on the projector and the other end into another projector to daisy-chain the projectors.

Shutting down the projector

Auto Power Off

The projector has an Auto Power Off feature that automatically turns the projector off if no active sources are detected and no user interaction with the projector is performed for 20 minutes. By default, this feature is off.

Turning off the projector

To turn the projector off, press the **Power** button on the remote or keypad twice. The lamp turns off and the LED blinks orange for 10 seconds while the fans continue to run to cool the lamp. When the lamp has cooled, the LED lights red and the fans stop. Unplug the power cable and turn off the power switch to completely power off the projector.

Troubleshooting your setup

The Status Indicator LEDs on top of the projector indicates the state of the projector and is helpful when troubleshooting.

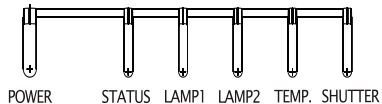
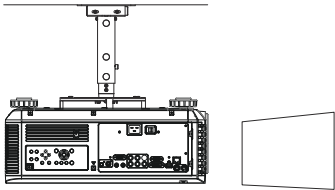
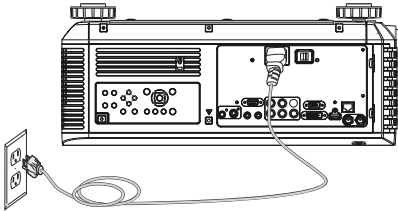
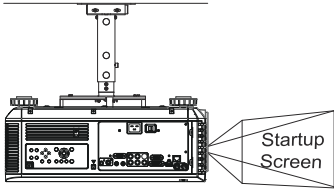
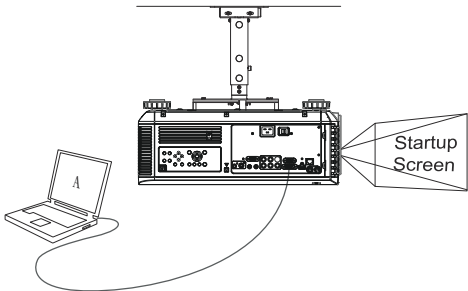
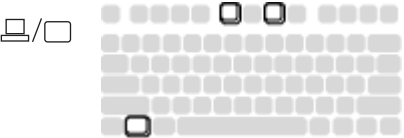

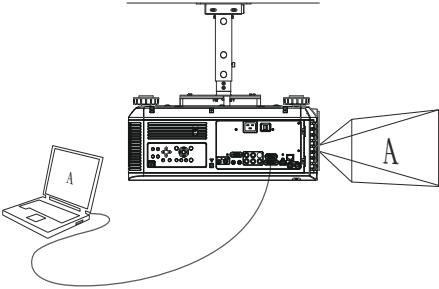

Table 1: Status indicator LED behavior and meaning

LED Indicator	Meaning
Power: Solid red Blinking green Solid green Blinking orange	The projector is plugged in. The power button has been pressed and the software is initializing. The projector is on and initialized. The power button has been pressed to turn the projector off and the fans are running to cool the projector.
Status	Turn the projector off and wait one minute, then turn the projector on again. If the Status LED turns on again, service is required. Visit www.infocus.com/support to contact service.
Lamp 1/Lamp 2: Flashing Green Solid Green Flashing Red Solid Red	The lamp is warming up. The lamp is on. A lamp error occurred. Turn the projector off and wait one minute, then turn the projector on again. If the lamp light turns on again, replace the lamp and reset the lamp timer (page 35). Note: the projector may need to be serviced. The lamp needs to be replaced.
Temp	The projector is too hot. Make sure the vents aren't blocked (see page 18). Turn the projector off and wait one minute, then turn the projector on again. Contact Technical Support if the problem persists. Visit www.infocus.com/support to contact service.
Shutter	The shutter is closed. Press the Shutter button to open the shutter.

Problem	Solution	Result
<p data-bbox="48 120 274 146">No start up screen.</p> 	<p data-bbox="661 120 1159 197">Plug the power cord into the projector, turn on the power switch and press the power button.</p> 	<p data-bbox="1183 120 1362 146">Correct image.</p> 
<p data-bbox="48 510 430 537">Only the start up screen appears.</p> 	<p data-bbox="661 510 1038 560">Press the Input button to activate the laptop's external port.</p>  <p data-bbox="673 843 829 870">Restart laptop</p> 	<p data-bbox="1183 510 1506 537">Computer image projected.</p> 

Problem

No computer image, just the words “Signal out of range.”

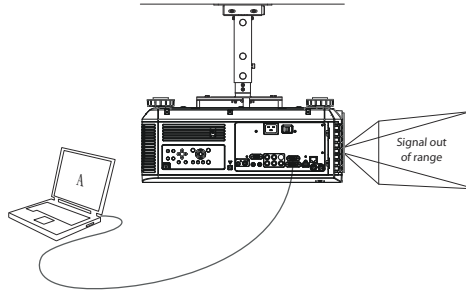

Solution

Press the Auto Sync button on the keypad or remote. To adjust computer refresh rate, go to Control Panel > Display > Settings > Adapter (location varies by operating system).

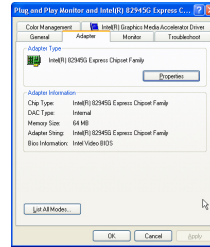

You may also need to set a different resolution on your computer, as shown in the following problem, “image fuzzy or cropped.”

Result

Computer image projected.

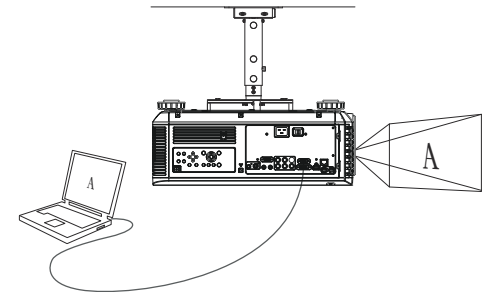

Only my laptop's background appears, not the Desktop icons.

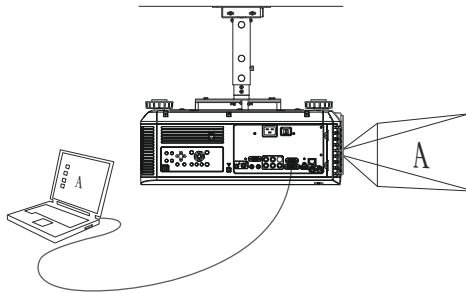

Windows - Disable “Extend my Windows Desktop” in Control Panel > Display > Settings > Display 2 (location varies by operating system).

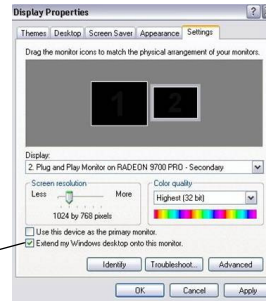

Uncheck this option, then click Apply

Background and Desktop projected.

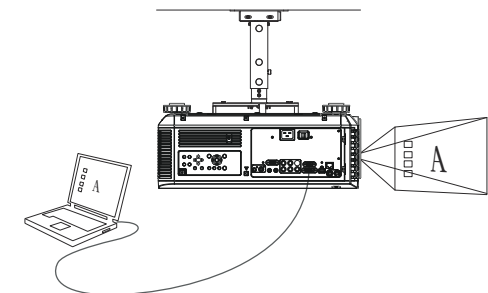

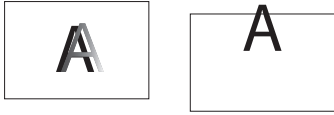





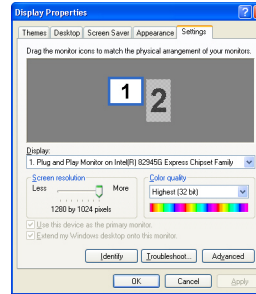
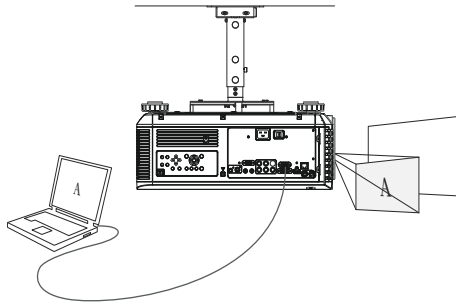
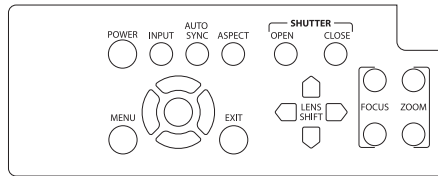
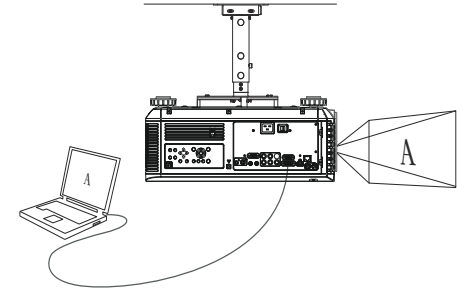

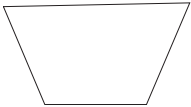

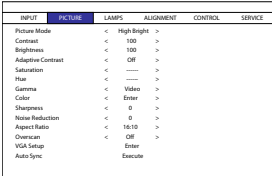

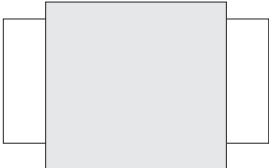
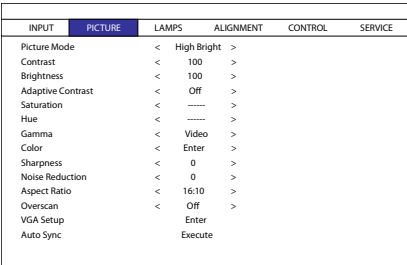
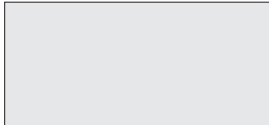
Problem**Image fuzzy or cropped****Solution**

Set your computer's display resolution to the native resolution of the projector (Start > Settings > Control Panel > Display > Settings tab).

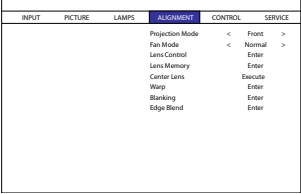
For a laptop, disable laptop monitor or turn-on dual-display mode

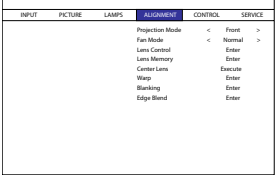
**Result****Image clear and not cropped.****Image not centered on screen.****Adjust Lens Shift using the keypad or remote.****Correct image.**

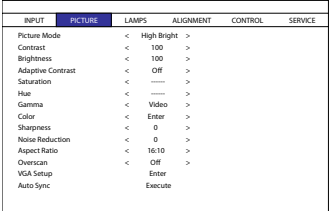
Problem	Solution	Result																																																																																										
<p>Image not square.</p> 	<p>Adjust the angle of the projector, so that it is square with the screen.</p>	<p>Square image.</p> 																																																																																										
<p>Image not sharp.</p> 	<p>Adjust Sharpness in the Picture menu.</p>  <table border="1" data-bbox="743 397 1015 572"> <thead> <tr> <th>INPUT</th> <th>PICTURE</th> <th>LAMPS</th> <th>ALIGNMENT</th> <th>CONTROL</th> <th>SERVICE</th> </tr> </thead> <tbody> <tr> <td>Picture-Mode</td> <td><</td> <td>High Bright</td> <td>></td> <td></td> <td></td> </tr> <tr> <td>Contrast</td> <td><</td> <td>100</td> <td>></td> <td></td> <td></td> </tr> <tr> <td>Brightness</td> <td><</td> <td>100</td> <td>></td> <td></td> <td></td> </tr> <tr> <td>Adaptive Contrast</td> <td><</td> <td>Off</td> <td>></td> <td></td> <td></td> </tr> <tr> <td>Saturation</td> <td><</td> <td>-----</td> <td>></td> <td></td> <td></td> </tr> <tr> <td>Hue</td> <td><</td> <td>-----</td> <td>></td> <td></td> <td></td> </tr> <tr> <td>Gamma</td> <td><</td> <td>Video</td> <td>></td> <td></td> <td></td> </tr> <tr> <td>Color</td> <td><</td> <td>Enter</td> <td>></td> <td></td> <td></td> </tr> <tr> <td>Sharpness</td> <td><</td> <td>0</td> <td>></td> <td></td> <td></td> </tr> <tr> <td>Noise Reduction</td> <td><</td> <td>0</td> <td>></td> <td></td> <td></td> </tr> <tr> <td>Aspect Ratio</td> <td><</td> <td>16:10</td> <td>></td> <td></td> <td></td> </tr> <tr> <td>Overscan</td> <td><</td> <td>Off</td> <td>></td> <td></td> <td></td> </tr> <tr> <td>VGA Setup</td> <td><</td> <td>Enter</td> <td>></td> <td></td> <td></td> </tr> <tr> <td>Auto Sync</td> <td><</td> <td>Execute</td> <td>></td> <td></td> <td></td> </tr> </tbody> </table>	INPUT	PICTURE	LAMPS	ALIGNMENT	CONTROL	SERVICE	Picture-Mode	<	High Bright	>			Contrast	<	100	>			Brightness	<	100	>			Adaptive Contrast	<	Off	>			Saturation	<	-----	>			Hue	<	-----	>			Gamma	<	Video	>			Color	<	Enter	>			Sharpness	<	0	>			Noise Reduction	<	0	>			Aspect Ratio	<	16:10	>			Overscan	<	Off	>			VGA Setup	<	Enter	>			Auto Sync	<	Execute	>			<p>Correct image.</p> 
INPUT	PICTURE	LAMPS	ALIGNMENT	CONTROL	SERVICE																																																																																							
Picture-Mode	<	High Bright	>																																																																																									
Contrast	<	100	>																																																																																									
Brightness	<	100	>																																																																																									
Adaptive Contrast	<	Off	>																																																																																									
Saturation	<	-----	>																																																																																									
Hue	<	-----	>																																																																																									
Gamma	<	Video	>																																																																																									
Color	<	Enter	>																																																																																									
Sharpness	<	0	>																																																																																									
Noise Reduction	<	0	>																																																																																									
Aspect Ratio	<	16:10	>																																																																																									
Overscan	<	Off	>																																																																																									
VGA Setup	<	Enter	>																																																																																									
Auto Sync	<	Execute	>																																																																																									
<p>Image does not fit 4:3 or 16:9 screen.</p> 	<p>Change Aspect Ratio to 4:3 or 16:9 in the Picture menu.</p>  <table border="1" data-bbox="675 669 1083 933"> <thead> <tr> <th>INPUT</th> <th>PICTURE</th> <th>LAMPS</th> <th>ALIGNMENT</th> <th>CONTROL</th> <th>SERVICE</th> </tr> </thead> <tbody> <tr> <td>Picture-Mode</td> <td><</td> <td>High Bright</td> <td>></td> <td></td> <td></td> </tr> <tr> <td>Contrast</td> <td><</td> <td>100</td> <td>></td> <td></td> <td></td> </tr> <tr> <td>Brightness</td> <td><</td> <td>100</td> <td>></td> <td></td> <td></td> </tr> <tr> <td>Adaptive Contrast</td> <td><</td> <td>Off</td> <td>></td> <td></td> <td></td> </tr> <tr> <td>Saturation</td> <td><</td> <td>-----</td> <td>></td> <td></td> <td></td> </tr> <tr> <td>Hue</td> <td><</td> <td>-----</td> <td>></td> <td></td> <td></td> </tr> <tr> <td>Gamma</td> <td><</td> <td>Video</td> <td>></td> <td></td> <td></td> </tr> <tr> <td>Color</td> <td><</td> <td>Enter</td> <td>></td> <td></td> <td></td> </tr> <tr> <td>Sharpness</td> <td><</td> <td>0</td> <td>></td> <td></td> <td></td> </tr> <tr> <td>Noise Reduction</td> <td><</td> <td>0</td> <td>></td> <td></td> <td></td> </tr> <tr> <td>Aspect Ratio</td> <td><</td> <td>16:10</td> <td>></td> <td></td> <td></td> </tr> <tr> <td>Overscan</td> <td><</td> <td>Off</td> <td>></td> <td></td> <td></td> </tr> <tr> <td>VGA Setup</td> <td><</td> <td>Enter</td> <td>></td> <td></td> <td></td> </tr> <tr> <td>Auto Sync</td> <td><</td> <td>Execute</td> <td>></td> <td></td> <td></td> </tr> </tbody> </table>	INPUT	PICTURE	LAMPS	ALIGNMENT	CONTROL	SERVICE	Picture-Mode	<	High Bright	>			Contrast	<	100	>			Brightness	<	100	>			Adaptive Contrast	<	Off	>			Saturation	<	-----	>			Hue	<	-----	>			Gamma	<	Video	>			Color	<	Enter	>			Sharpness	<	0	>			Noise Reduction	<	0	>			Aspect Ratio	<	16:10	>			Overscan	<	Off	>			VGA Setup	<	Enter	>			Auto Sync	<	Execute	>			<p>Correct image.</p> 
INPUT	PICTURE	LAMPS	ALIGNMENT	CONTROL	SERVICE																																																																																							
Picture-Mode	<	High Bright	>																																																																																									
Contrast	<	100	>																																																																																									
Brightness	<	100	>																																																																																									
Adaptive Contrast	<	Off	>																																																																																									
Saturation	<	-----	>																																																																																									
Hue	<	-----	>																																																																																									
Gamma	<	Video	>																																																																																									
Color	<	Enter	>																																																																																									
Sharpness	<	0	>																																																																																									
Noise Reduction	<	0	>																																																																																									
Aspect Ratio	<	16:10	>																																																																																									
Overscan	<	Off	>																																																																																									
VGA Setup	<	Enter	>																																																																																									
Auto Sync	<	Execute	>																																																																																									

Problem	Solution	Result
<p>Image upside down.</p> 	<p>Turn Projection Mode to Front in the Alignment menu.</p> 	<p>Correct image.</p> 
<p>Image reversed left to right.</p> 	<p>Turn Projection Mode to Front in the Alignment menu.</p> 	<p>Correct image.</p> 
<p>Projected colors don't match source.</p> 	<p>Adjust color, tint, brightness, contrast in the Picture menu and/or color space in the Input menu.</p> 	<p>Correct image.</p> 

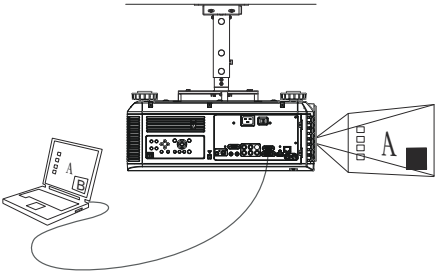
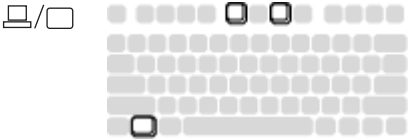
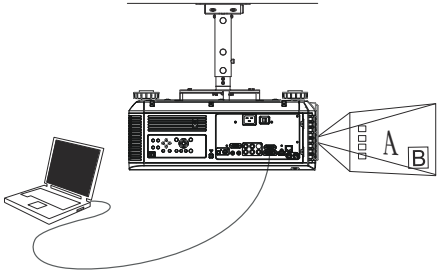
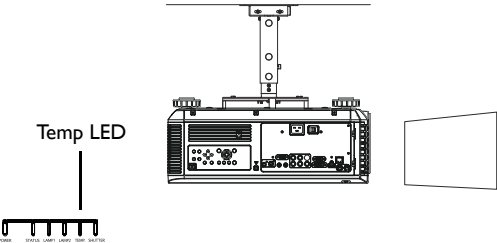
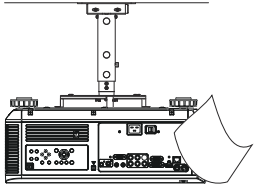
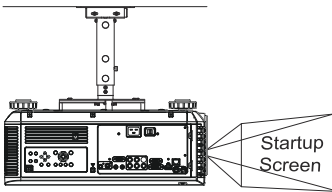
Problem	Solution	Result
<p data-bbox="48 89 517 146">The video embedded in my PowerPoint presentation does not play on the screen.</p> 	<p data-bbox="604 89 1152 118">Turn off the internal LCD display on your laptop.</p> 	<p data-bbox="1183 89 1546 118">Embedded video plays correctly.</p> 
<p data-bbox="48 525 560 554">Lamp won't turn on and the Temp LED is on.</p> 	<p data-bbox="604 525 1147 583">Make sure vents aren't blocked, turn the projector off and allow it to cool for one minute.</p> 	<p data-bbox="1183 525 1355 554">Lamp turns on.</p> 

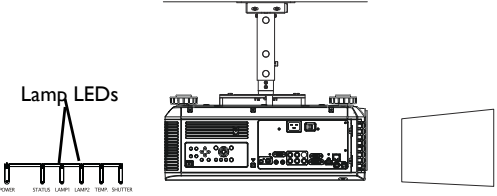
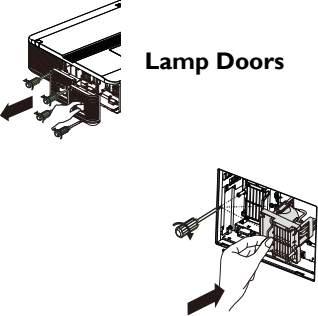
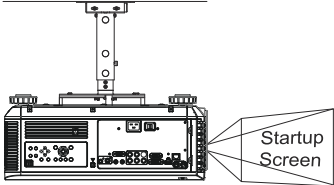
Problem	Solution	Result
<p data-bbox="48 101 562 153">Lamps won't turn on and the Lamp LEDs are turned on.</p>  <p data-bbox="93 265 197 288">Lamp LEDs</p> <p data-bbox="1593 303 1663 348">Startup Screen</p>	<p data-bbox="604 110 1086 138">The lamps must be replaced (see page 34).</p>  <p data-bbox="795 211 939 234">Lamp Doors</p> <p data-bbox="991 360 1083 406">Replace lamps</p>	<p data-bbox="1182 89 1355 118">Lamps turn on.</p>  <p data-bbox="1593 303 1663 348">Startup Screen</p>

Still need assistance?

If you need assistance, visit our support website at www.infocus.com/support or call us. Check out the How To section for additional information on using this projector for home theater or gaming applications.

This product is backed by a limited warranty. An extended warranty plan may be purchased from your dealer. When sending the projector in for repair, we recommend shipping the unit in its original packing material, or having a professional packaging company pack the unit. Please insure your shipment for its full value.

Using the remote control

The remote uses two (2) AA batteries (not included). Install batteries by removing the cover from the remote's back, aligning the + and - ends of the batteries, sliding them into place, and then replacing the cover.

Caution:

- When disposing of batteries, be sure to do so in an environmentally proper manner.
- If the remote control gets wet, wipe it dry immediately.
- Avoid excessive heat and humidity.
- Ensure the batteries' polarity (+/-) is aligned correctly.
- Do not mix new and old batteries together, or different types of batteries together.
- Replace the batteries as soon as they run out.
- Remove the batteries from the remote control when storing or when the remote will not be used for a prolonged period.

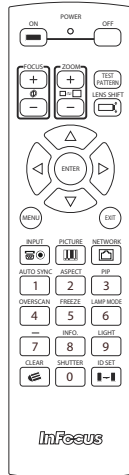

To operate, point the remote at the projector (not at the computer). The range of optimum operation is about 30' (9m).

Press the remote's **Power On** and **Off** buttons to turn the projector on and off (see page 12 for shutdown information).

Press the remote's **Menu** button to open the projector's menu system. Use the arrow buttons to navigate, and the **Enter** button to select features and adjust values in the menus. See page 23 for more information on the menus.

The remote also has:

- **Focus** button turns on the focus control.
- **Zoom** button turns on the zoom control.
- **Test Pattern** button toggles between different test patterns.
- **Lens Shift** button turns on the lens shift control.
- **Exit** closes the onscreen menus (page 23).
- **Input** button to switch between sources.
- **Picture** button toggles between different picture modes.
- **Network** button displays network information.
- **Auto Sync** button resynchronizes the projector to the source.
- **Aspect** button toggles between aspect ratios (see page 25).
- **PiP** button turns on the PiP feature.
- **OverScan** button toggles between overscan modes.
- **Freeze** button freezes/unfreezes the source image being displayed.
- **Lamp Mode** button toggles between single and dual lamp mode.
- - button is not used on this projector.
- **Info.** button displays projector and source information.
- **Light** button turns on the remote's backlight.
- **Clear** button clears the ID Set entry information.
- **Shutter** button to blank the screen.
- **ID Set** button allows the user to specify the remote and projector ID set. This is helpful when more than one projector is used in a room. See the Setting an ID Code for the Remote and Projector section on the next page.

Wired Remote Option

If the wireless range of the remote is not sufficient, the remote can be wired directly into the projector's Wired Remote connector.

Setting an ID Code for the Remote and Projector

A unique ID number can be set, pairing both the projector and remote, so that the remote will only control the projector it is paired with.

Note: Always press and hold the ID Set button before pressing any other buttons on the remote and always release the **ID Set** button after releasing the other buttons.

To review the current ID Code settings: Press and hold the **ID Set** button on the remote for 5-8 seconds.

If the projector and remote ID codes have never been set, the following message displays, "[PJ_ID] X ... [RC_ID] X ... [RC_TBL] 0".

PJ_ID refers to the current projector ID number and RC_ID refers to the current remote ID number.

RC_TBL refers to the remote control table and displays 1 if the projector and remote are paired or 0 if they are not paired.

To set the ID Code:

- 1 Using the "RSE" RS232 command (see "Control commands" on page 47 for more information), set the projector ID code. Valid commands are RSE1 through RSE9. For example, RSE3 sets the projector ID code to "3".
- 2 To verify that the projector ID number has been set correctly, press and hold the ID Set button on the remote for 5-8 seconds and verify that the projector ID number ([PJ_ID]) displays the number you entered using the RSE command. In our example, the following message would display, "[PJ_ID] 3 ... [RC_ID] X ... [RC_TBL] 0".
- 3 To set the remote ID number, press and hold the **ID Set** button and **Menu** button simultaneously for 5-8 seconds or until the message, "Please press ID SET + #", displays.
- 4 While continuing to hold the **ID Set** button, release the **Menu** button and

press the button which corresponds with the projector ID number set in Step #1. For example, pressing **ID Set** and "3" on the remote will set the remote ID code to "3".

- 5 Continue holding these buttons until a confirmation message appears. For example, if both the projector and remote ID codes are set to "3" successfully, the message, "[PJ_ID] 03 ... [RC_ID] 03 ... [RC_TBL] 1" displays. **Note:** If the PJ_ID and RC_ID numbers match, but the RC_TBL displays 0, press and hold the ID Set button for an additional 5-8 seconds.
- 6 The projector and remote are now paired. Other remotes will not operate this projector.

To clear the current ID Code settings: Press and hold the **ID Set** button and the Clear button simultaneously for 5-8 seconds, or until the message "ID Cleared" displays. This clears the remote ID number.

Note: It is not necessary to clear the projector ID number, however if you wish to do this, you must reset the projector ID number using the RSE command code "RSE255".

Troubleshooting the remote

- Make sure the batteries are installed in the proper orientation and are not dead.
- Make sure you're pointing the remote at the projector or the screen, not the computer, and are within the remote range of 32.8' (10m) at +/- 30 degrees. For best results, point the remote at the projector.

Using the keypad buttons

Most buttons are described in detail in other sections, but here is an overview of their functions:

Power—turns the projector on and off (page 8).

Input—changes the active source (page 8).

Auto Sync—resynchronizes the projector to the source.

Aspect - toggles between different aspect ratio modes.

Shutter Open - opens the shutter.

Shutter Close - closes the shutter.

Menu - opens the onscreen menus (page 23).

Up/Down/Left/Right arrows—navigates to and adjusts settings in the menus (page 23).

Enter - confirms choices made in the menus (page 23).

Exit - closes the onscreen menus (page 23).

Lens Shift - shifts the lens position up, down, left and right.

Focus +/- - adjusts the focus of the image.

Zoom +/- - increases and decreases the image size.

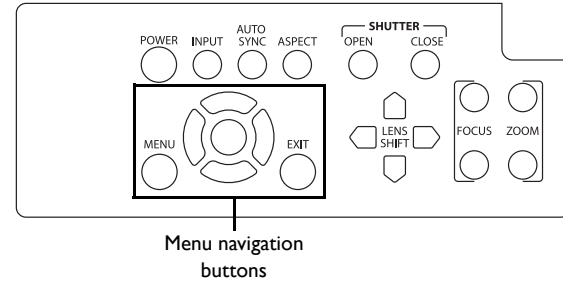

Using the menus

To open the menus, press the **Menu** button on the keypad or remote. Use the left and right arrow buttons to move between the menus, and the up and down to navigate to the desired menu item.

Once a menu item is highlighted, the left and right arrow buttons can be used to adjust the value, select an option, turn the feature on or off, or enter a submenu.

Press the **Exit** button to exit the menu system immediately or press the **Menu** button to go back to the main menu bar and ultimately close the menus.

The menus are grouped by usage:

- The Input menu provides source specific selection and adjustments.
- The Picture menu provides common image adjustments.
- The Lamps menu provides lamp selection and power adjustments.
- The Alignment menu provides installation specific adjustments.
- The Control menu provides set-up type adjustments that are not changed often.
- The Service menu provides information about the projector and source.

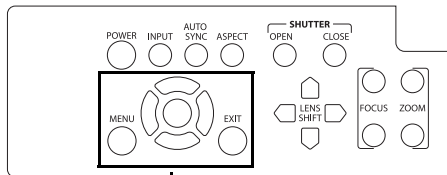

Menu navigation buttons

INPUT	PICTURE	LAMPS	ALIGNMENT	CONTROL	SERVICE
Input Selection		Enter			
PIP		Enter			
Text Pattern		Enter			
Color Space	<	Auto	>		
Input Lock	<	Auto	>		
Background	<	Logo	>		
Video Standard	<	----	>		
Auto Sync Adjust	<	Always	>		

Input menu

INPUT	PICTURE	LAMPS	ALIGNMENT	CONTROL	SERVICE
Picture Mode	<	High Bright	>		
Contrast	<	100	>		
Brightness	<	100	>		
Adaptive Contrast	<	OFF	>		
Saturation	<	----	>		
Hue	<	----	>		
Gamma	<	Video	>		
Color	<	Enter	>		
Sharpness	<	0	>		
Noise Reduction	<	0	>		
Aspect Ratio	<	16:10	>		
Overscan	<	OFF	>		
WGA Setup	<	Enter	>		
Auto Sync				Execute	

Picture Menu

INPUT	PICTURE	LAMPS	ALIGNMENT	CONTROL	SERVICE
Mode		<	High Bright	>	
Power		<	Eco	>	
High Altitude		<	OFF	>	
Custom Power Level		<	OFF	>	
Lamp 1 Status			OFF		
Lamp 2 Status			On		

Lamps menu

INPUT	PICTURE	LAMPS	ALIGNMENT	CONTROL	SERVICE
Projection Mode	<	Front	>		
Fan Mode	<	Normal	>		
Lens Control			Enter		
Lens Memory			Enter		
Center Lens			Execute		
Warp			Enter		
Blanking			Enter		
Edge Blend			Enter		

Alignment menu

INPUT	PICTURE	LAMPS	ALIGNMENT	CONTROL	SERVICE
Eco Network Power	<	Standard	>		
Auto Power Off	<	OFF	>		
Auto Power On	<	OFF	>		
Projector Control	<	Network	>		
Network			Enter		
Start Up Logo	<	On	>		
Trigger	<	Auto	>		
Auto Search	<	OFF	>		
Dynamic Black	<	OFF	>		
Language	<	Enter	>		

Control menu

INPUT	PICTURE	LAMPS	ALIGNMENT	CONTROL	SERVICE
Model:					16552L
Serial Number:					C27700000807
Software Version:					ME01-GE02-UR02-5050-39-DPNE02-P03-E07
Active/PP Source:					VGA / OFF
Pixel Clock:					88.51 MHz
Signal Format:					1280x800@60Hz
H/V Refresh Rate:					H: 49.726 KHZ V: 60 HZ
Lamp 1 Time:					5 HRS
Lamp 2 Time:					5 HRS
Power On Time:					5 HRS
Blue Only	<	OFF	>		
Factory Reset				Enter	

Service menu

Input menu

Input Selection: Allows you to choose the source you wish to display.

PiP: Allows you to display two distinct sources simultaneously, switch sources, and choose between five different PiP placement options.

Press the **Enter** button on the remote or control panel to access the PiP submenu. Turn on the PiP Option to access the PiP Input, PiP Swap and Position features. Review “PiP Compatibility” on page 46 for PiP configuration options.

Test Pattern: Allows you to choose between various test pattern screens.

Color Space: This option applies to computer and component video sources. It allows you to select a color space that has been specifically tuned for the input signal. When **Auto** is selected, the projector automatically determines the standard. To choose a different setting, turn off **Auto**, then choose between the other computer and video options.

Input Lock: Allows you to manually select the output frame rate (48Hz, 50Hz or 60Hz). When **Auto** is selected, the projector automatically determines the standard.

Background: Allows you to select a blank blue, black or white startup screen instead of the default InFocus logo.

Video Standard: Allows you to select a video standard that has been specifically tuned for the input signal. When **Auto** is selected, the projector automatically determines the standard. To choose a different setting, turn off **Auto**, then choose between the other options.

Auto Sync Adjust: Allows you choose when you would like the projector to synchronize the image. **Auto** will synchronize the image when a different timing is detected. **Always** will synchronize the image each time a new source is detected.

Off never synchronizes the image.

INPUT	PICTURE	LAMPS	ALIGNMENT	CONTROL	SERVICE
Input Selection				Enter	
PiP				Enter	
Test Pattern				Enter	
Color Space	<	Auto	>		
Input Lock	<	Auto	>		
Background	<	Logo	>		
Video Standard	<	-----	>		
Auto Sync Adjust	<	Always	>		

Input menu

Picture menu

Picture Mode: Presets are provided that optimize the projector for displaying computer presentations and video images under certain conditions. Select between High Bright, Presentation and Video.

Contrast: Controls the degree of difference between the lightest and darkest parts of the picture and changes the amount of black and white in the image.

Brightness: Changes the intensity of the image.

Adaptive Contrast: Turn on this feature to allow the projector to modify the contrast ratio based on the different areas of the image.

Saturation: Composite/S-video sources only. Allows you to adjust the color saturation levels of the image.

Hue: Composite/S-video sources only. Allows you to adjust the color hue.

Gamma: Allows you to choose Video, Film, and Graphics color gamma options.

Color: Press the **Enter** button on the remote or control panel to access the color submenu.

- **Color Temperature:** Changes the intensity of the colors. Select a listed relative warmth value. (Composite/S-video sources only.)
- **Trim:** Allows you to change the color lift (offset) and color gain of the red, green and blue channels.

Sharpness: Changes the clarity of the edges of a video image. Select a sharpness setting.

Noise Reduction: Reduces temporal and/or spatial noise in the image.

Aspect Ratio: Adjusts ratio of the image width to image height. Choose between 16:9, 1.88, 2.35, Letterbox, Native, Unscaled, 5:4, 4:3, and 16:10.

Overscan: Removes noise around the video image.

VGA Setup: Press the **Enter** button on the remote or control panel to access the VGA Setup submenu. You can adjust H total, H Start, H Phase, and V Start.

Auto Sync: Forces the projector to reacquire and lock to the input signal. This is useful when signal quality is marginal. Press the **Enter** button on the remote or control panel to automatically synchronize the signal.

INPUT	PICTURE	LAMPS	ALIGNMENT	CONTROL	SERVICE
Picture Mode	<	High Bright	>		
Contrast	<	100	>		
Brightness	<	100	>		
Adaptive Contrast	<	OFF	>		
Saturation	<	-----	>		
Hue	<	-----	>		
Gamma	<	Video	>		
Color	<	Enter	>		
Sharpness	<	0	>		
Noise Reduction	<	0	>		
Aspect Ratio	<	16:10	>		
Overscan	<	OFF	>		
VGA Setup	<	Enter	>		
Auto Sync	<	Execute	>		

Picture menu

Lamps menu

Mode: Allows you to choose between single and dual lamp modes. Note: When using single lamp mode, the lamp with the least number of lamp hours turns on. Individual lamps are not user selectable.

Power: Allows you to choose between Normal, Custom Power Level, and Eco power levels. When Custom Power Level is chosen, the Custom Power Level menu item becomes adjustable. When Eco is chosen, the lamp output and the fan speed are lowered, making the lamp dimmer and the projector quieter.

High Altitude: This feature should be turned **On** when the projector is being used in an environment at 5500' (1600m) and above sea level. Note: Turning High Altitude On will cause the fan to run faster and slightly louder. If the projector is used above 5500' (1600') and this feature is Off, the projector may shut down and overheat.

Custom Power Level: Allows you to adjust the power level you want manually. Use the left and right arrow buttons to adjust the level. Press the **Menu** button to return to the menu system or **Exit** to exit the Custom Power Level feature and the menu system. Note: Power must be set to Custom Power Level to access this feature.

Lamp 1 Status: Displays the status of Lamp 1. This is a read-only item. To select single and dual lamp modes, use **Mode**.

Lamp 2 Status: Displays the status of Lamp 2. This is a read-only item. To select single and dual lamp modes, use **Mode**.

INPUT	PICTURE	LAMPS	ALIGNMENT	CONTROL	SERVICE
		Mode	<	High Bright	>
		Power	<	Eco	>
		High Altitude	<	Off	>
		Custom Power Level	<	Off	>
		Lamp 1 Status		Off	
		Lamp 2 Status		On	

Lamps menu

Alignment menu

Projection Mode: Allows you to change the orientation of the image for ceiling mounted, rear-projection and table-top orientations.

Fan Mode: Allows you to manually select the fan tilt position. By default, the position is horizontal (Normal), but if the projector is installed at an angle, it is recommended that the fan mode be changed to Up or Down accordingly. Note: Lamp life will be affected when Up or Down is selected. The fan speed also changes with each orientation.

Lens Control: Allows you to adjust the lens shift. This is the same as pressing the Lens Shift button on the keypad or remote.

Lens Memory: Allows you to save the lens shift, zoom and focus settings for a particular source into one of ten memory locations. Press the **Enter** button to access the Lens Memory submenu. Use the Save Memory feature to save up to 10 source-specific lens settings. Use Load Memory to restore a saved setting.

Center Lens: Press the **Enter** button on the remote or control panel to center the lens.

Warp: Allows you to adjust keystone, rotation, pincushion/barrel, and corner positions. This is especially useful when projecting on uneven or rounded surfaces and when stacking two projectors and overlaying the images.

Press the **Enter** button to access the submenu. To make warp adjustments, highlight the desired option and press the **Enter** button. Use the arrow keys to make adjustments. Select Reset to return to factory default settings.

Blanking: Allows you to adjust the display range (blanking) at the top, bottom, left and right edges of the input signal.

Edge Blend: When set to On, you can adjust the blend width and black level uplift. Align Patterns are also available.

INPUT	PICTURE	LAMPS	ALIGNMENT	CONTROL	SERVICE
			Projection Mode	<	Front >
			Fan Mode	<	Normal >
			Lens Control		Enter
			Lens Memory		Enter
			Center Lens		Execute
			Warp		Enter
			Blanking		Enter
			Edge Blend		Enter

Alignment menu

Control menu

Eco Network Power: When this feature is set to Standard, Projector Control is set to RS232 and all network functions continue to work when the projector is in standby (powered off but connected to AC Power). When this feature is set to Eco, network functions will not work when the projector is in standby.

Auto Power Off: When this feature is on, the projector is automatically turned off after no signals are detected for 20 minutes. If an active signal is received before the projector powers down, the image will be displayed.

Auto Power On: When this feature is on, the projector automatically turns on when electrical power is connected. This allows control of ceiling mounted projectors with a wall power switch.

Projector Control: Allows you to choose between RS232 and LAN projector control methods.

Network: Press **Enter** button to review the current network settings. Note: Network configuration and operation are made via the LAN Configuration Utility.

Start Up Logo: When this feature is on, the projector will display the InFocus logo upon start-up.

Trigger: If you enable this feature and connect your projection screen to this output using the cable that came with your screen, the screen will move down when the lamp is turned on and the screen will return to its storage position, when the lamp is turned off.

Auto Search: When this feature is on, the projector automatically finds the active source. To display another source, you must manually select one by pressing the **Input** button on the remote or keypad.

Dynamic Black: Turn this feature on when watching motion video in order to improve the contrast of darker scenes.

Language: Allows you to select a language for the onscreen menu.

INPUT	PICTURE	LAMPS	ALIGNMENT	CONTROL	SERVICE
			Eco Network Power	< Standard >	
			Auto Power Off	< OFF >	
			Auto Power On	< OFF >	
			Projector Control	< Network >	
			Network	Enter	
			Start Up Logo	< On >	
			Trigger	< Auto >	
			Auto Search	< OFF >	
			Dynamic Black	< OFF >	
			Language	Enter	

Control menu

Service menu

Model: Displays the model number of the projector (read-only).

Serial Number: Displays the serial number of the projector (read-only).

Software Version: Displays the current firmware version the projector is using (read-only).

Active/PIP Source: Displays the source type which is being used in the Picture-in-Picture window (read-only).

Pixel Clock: Displays the pixel clock settings of the current source (read-only).

Signal Format: Displays the signal format settings of the current source (read-only).

H/V Refresh Rate: Displays the horizontal and vertical refresh rate settings of the current source (read-only).

Lamp 1 Time: Displays the number of hours Lamp 1 has been used (read-only).

Lamp 2 Time: Displays the number of hours Lamp 2 has been used (read-only).

Power On Time: Displays the number of hours the projector has been used (read-only).

Blue Only: Displays a blue screen used for color calibration.

Factory Reset: Restores all settings to their defaults. Note: You must confirm this before the reset will occur by click “OK” to the Reset Everything? dialog box.

INPUT	PICTURE	LAMPS	ALIGNMENT	CONTROL	SERVICE
Model:					INSSZL
Serial Number :					C277XXXX00807
Software Version :					ME01-GE02-UB02-5050-39-DPNE02-P03-E07
Active/PIP Source :				VGA	/ OFF
Pixel Clock :					88.51 MHz
Signal Format :					1280x800@60Hz
H/V Refresh Rate :					H: 49.726 KHZ V: 60 HZ
Lamp 1 Time :					5 HRS
Lamp 2 Time :					3 HRS
Power On Time :					5 HRS
Blue Only				< OFF >	
Factory Reset					Enter

Service menu

Using Projector Web Controls

Projector Web Controls allow you to configure and control a networked projector via a web browser. **NOTE:** Projector web pages are always displayed in English.

Configuring and Controlling the Projector via a Web Browser

Before using Projector Web Controls, your projector must be configured properly with your network. Consult your network administrator before connecting the projector to your network. Incorrect network configuration of the projector may cause problems on your network.

You can control the projector and make adjustments via the network using a web browser on a computer that is connected to the same network as the projector.

NOTES:

- The computer and projector must each have proper IP addresses, and must share the same subnet mask and gateway. The default IP address of the projector is 192.168.0.100. The network settings of the projector can only be changed via a web browser.
- JavaScript must be enabled in your browser to use the projector web pages properly. If JavaScript is disabled, see the Help files for your web browser for details on how to enable it.
- Projector Control in the projector's Control menu must be set to Network. In order to have access to Projector Web Controls at all times, Eco Network Power in the Control menu must also be set to Standard.

Logging in

To log into Projector Web Controls, follow these steps:

- 1 Make sure the projector is connected to the network and connected to AC power.
- 2 Verify that the projector menu settings Control > Projector Control is set to Network.

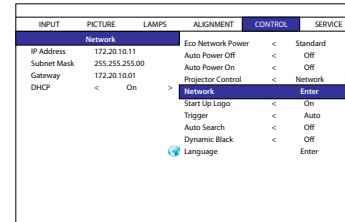

INPUT	PICTURE	LAMPS	ALIGNMENT	CONTROL	SERVICE
Network					
IP Address	172.20.10.11		Eco Network Power	<	Standard >
Subnet Mask	255.255.255.00		Auto Power Off	<	Off >
Gateway	172.20.10.01		Auto Power On	<	Off >
DHCP	<	On >	Projector Control	<	Network >
Network >					
			Start Up Logo	<	On >
			Trigger	<	Auto >
			Auto Search	<	Off >
			Dynamic Back	<	Off >
			Language	<	Enter >

Control > Network submenu

- 3 Go to Control > Network and press the **Enter** button on the remote. The IP address will display on the left-hand side. Verify that the DHCP setting is set to ON. Note: If you change the DHCP setting to ON, you may need to exit and re-enter the menu to see the IP address.
- 4 Open a web browser on your computer.
- 5 Enter the projector's IP address (preceded by http://) into the web browser's address bar. Example: If the IP address is 192.168.0.100, enter http://192.168.0.100 into the browser's address bar. Note: If you don't know the projector's IP address, turn on the projector and review the network information in the Control > Network submenu.
- 6 The web user interface will open. The projector information will display.

Using Projector Web Controls

Changes you make are applied immediately.

- **To change a numeric setting** (e.g. Brightness): Click the corresponding up or down button.
- **To perform a command** (e.g. Source): Click the corresponding button.

Controls Menu

Source/General Submenu: allows you to change the video source, turn the projector on or put it into standby, open and close the shutter, and set the projector control to network or RS232 control.

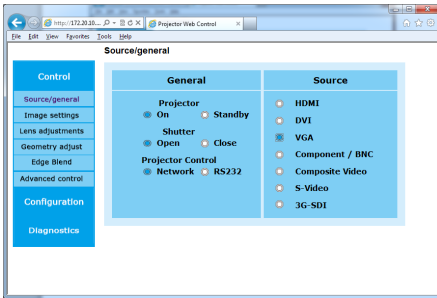
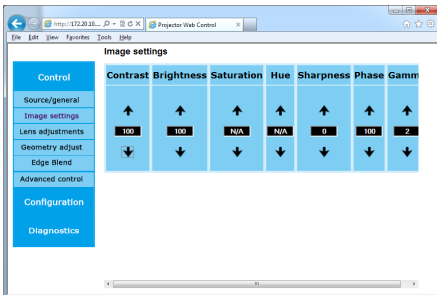
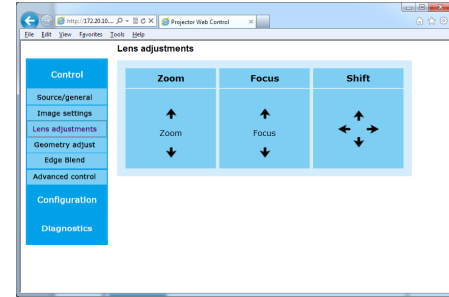

Image Settings Submenu: allows you to adjust contrast, brightness, saturation, hue, sharpness, phase and gamma for the projected video source.



Lens Adjustments Submenu: allows you to adjust the lens zoom, focus and position.



Geometry Adjust Submenu: allows you to adjust the blanking, warp, four corners and aspect ratio of the projector.

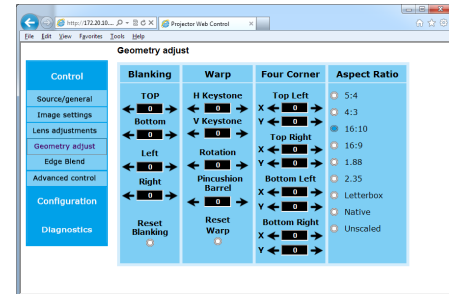

Edge Blend Submenu: allows you to adjust edge blend, blend width, black level uplift and black level uplift.

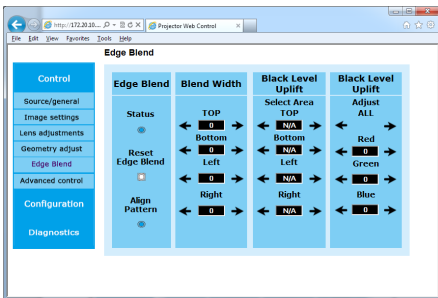

Advanced Control Submenu: allows you to adjust the color temperature, color offset and color gain of the projector.

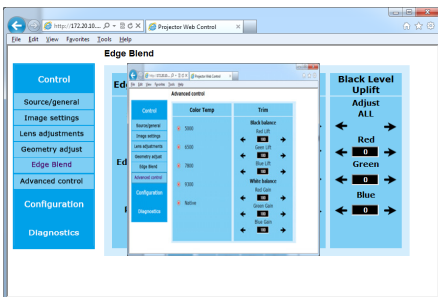

Configuration Menu

IP Configuration Submenu: allows you to manually enter the IP address configuration for your projector. Consult with your network administrator before making any changes on this page; incorrect network configuration of the projector may cause problems on your network.

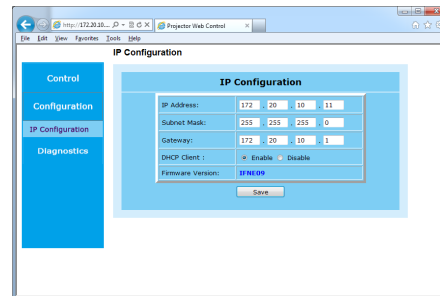

Advanced Diagnostic Submenu: displays read-only error code information used in troubleshooting.

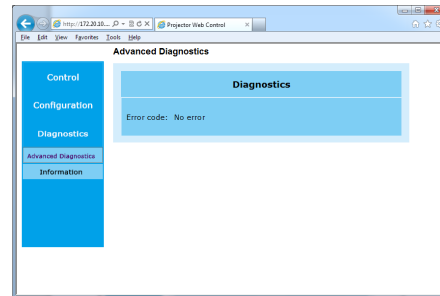

Information Submenu: displays a read-only page of projector information.

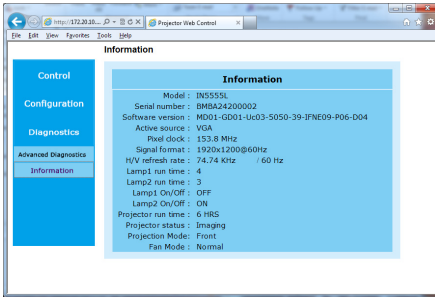

To upgrade Projector Network Firmware: Upgrades the firmware for the projector's network features (this firmware is separate from the regular projector firmware). Key in the IP address followed by "/firmwareUpdate.htm" on the URL box to activate the firmware update procedure. Follow the prompts to accomplish the upgrade.

Note: DHCP must be disabled or OFF in order for the "/firmwareUpdate.htm" feature to work.

Troubleshooting Network Functions

- If the network status displays "Not Connected" in the projector's Network menu, or if the projector does not display its IP address, check the cable and the network configuration.
- If your web browser displays "Page Not Found" or a similar error when you try to access the projector's web pages, verify that the projector is connected to the network. Note: Projector Control in the Control menu must be set to Network.
- Make sure Eco Network Power in the Control menu is set to Standard (if it is set to Eco, the projector web pages will not be available).

Maintenance

Cleaning the lens

- 1 Turn the projector off and unplug the power cord.
- 2 Apply a non-abrasive camera lens cleaner to a soft, dry cloth.
 - Avoid using an excessive amount of cleaner, and don't apply the cleaner directly to the lens. Abrasive cleaners, solvents or other harsh chemicals might scratch the lens.
- 3 Lightly wipe the cleaning cloth over the lens in a circular motion.

WARNINGS:

- Turn the projector off and unplug power cord before cleaning any part of the projector.
- Do not open any cover on the projector, except the lamp cover or projector top cover.
- Do not attempt to service this product yourself as opening and removing covers will void the warranty and may expose you to dangerous voltage and other hazards. Refer all servicing to qualified service personnel.

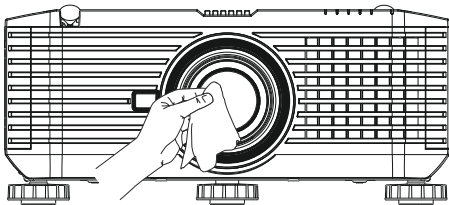

Replacing the projection lamp

The lamp hours timer counts the number of hours each lamp has been in use. When the lamp time has expired, the Lamp LED (Lamp1 or Lamp2) on top of the projector will light solid red.

- **NOTE:** Be sure to use the InFocus lamp module designed for this projector. You can order new lamps from www.infocus.com (in select areas), your retailer or your dealer. **Only genuine InFocus lamps are tested for use in this projector.** Use of non InFocus lamps may cause electrical shock and fire, and may void the projector warranty. InFocus is not liable for the performance, safety or certification of any other lamps.

WARNINGS:

- The projector uses two high-pressure mercury glass lamps. The lamps may fail prematurely or rupture with a popping sound if jolted, scratched, or handled while hot. The risk of lamp failure or rupture also increases as the lamp age increases; it is recommended that both lamps be replaced simultaneously when a Lamp LED (Lamp1 or Lamp2) is solid red.
- To avoid burns, allow the projector to cool for at least 60 minutes before you replace the lamps.
- Unplug the power cord before replacing the lamps.
- Do not drop the lamp modules. The glass may shatter and cause injury.
- Do not touch the glass surface of the lamp modules. Fingerprints can obscure projection sharpness and may cause the glass to shatter.
- Be extremely careful when removing the lamp modules. In the unlikely event that a lamp ruptures, small glass fragments may be generated. Although the lamp modules are designed to contain most of these fragments, use caution when removing them.
- Before replacing a ruptured lamp, clean the lamp compartment and dispose of cleaning materials. Wash hands after lamp replacement.
- When replacing the lamps while the projector is ceiling-mounted, wear protective eyewear to prevent eye injury.
- Hg – Lamp contains mercury. Manage in accordance with local disposal laws. See www.lamprecycle.org.

- 1 Turn the projector off and unplug the power cord.
- 2 Wait 60 minutes to allow the projector to cool thoroughly.
- 3 Remove the lamp doors by loosening 2 captive screws on each lamp door and pulling the doors straight off being careful not to damage the ground wires connecting the doors to the projector. Note: Do not remove the ground wires.
- 4 Loosen the 3 captive shoulder screws (marked by arrows) that attach the first lamp module to the projector. Carefully remove the lamp module. Do the same for the second lamp module. Dispose of the lamps in an environmentally proper manner in accordance with local disposal laws.
- 5 Carefully align and insert the new lamp modules and tighten the screws.
- 6 Replace the lamp doors and secure the screws.
- 7 Plug in the power cord, turn on the power switch and press the **Power** button to turn the projector back on. Note: Connection to a circuit with a minimum of 20A capacity is recommended.
- 8 To reset the lamp hour timer, use the RS232 commands, LMR (Lamp 1) and LDR (Lamp 2). See "Control commands" on page 47 for more information.

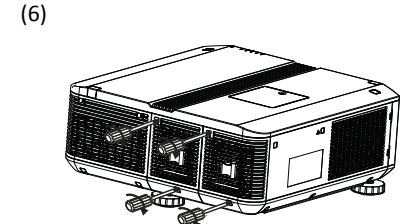
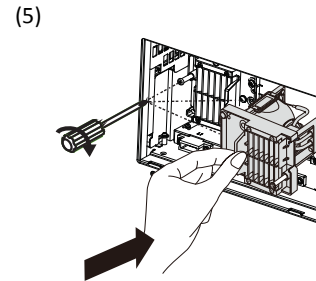
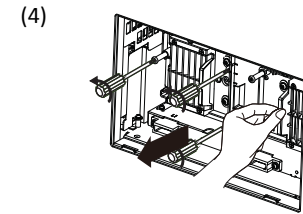
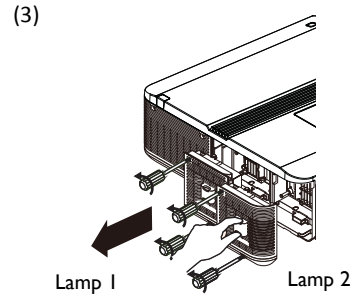
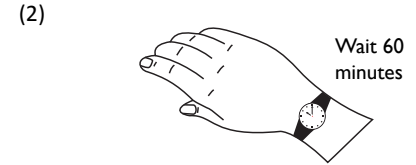
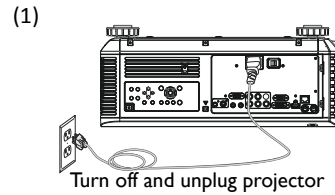

Replacing the lens

This projector is shipped without a lens. You can order a lens from www.infocus.com (in select areas), your retailer or your dealer.

- 1 Turn the projector off and unplug the power cord.
- 2 Wait 60 minutes to allow the projector to cool thoroughly.
- 3 If a lens is not attached, remove the dust cap from the projector and go to Step 6.
- 4 If a lens is attached, press and hold the release button located near the lens (marked "Press: Release lens") to release the lock.
- 5 Twist the lens counter-clockwise and carefully remove it from the front of the projector. Release the release button.
- 6 Insert the new lens into the projector carefully, arrow side up, through the front of the projector. Turn the lens clockwise until you hear a click.
- 7 Plug in the power cord, turn on the power switch and press the **Power** button to turn the projector back on. Note: Connection to a circuit with a minimum of 20A capacity is recommended.
- 8 Activate the Center Lens feature in the Alignment menu. (This will allow the lens to work properly.)

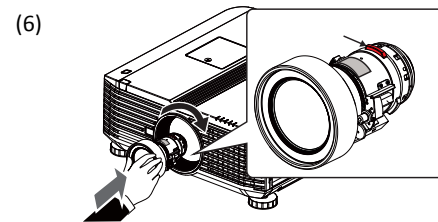
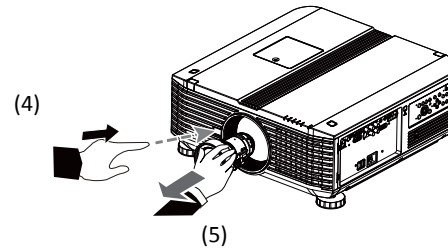
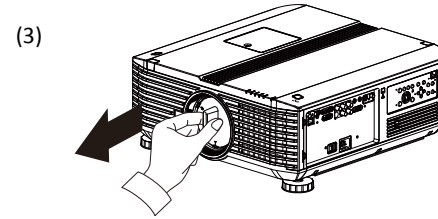
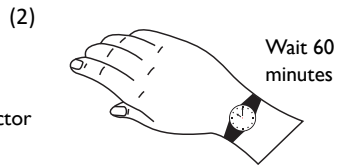
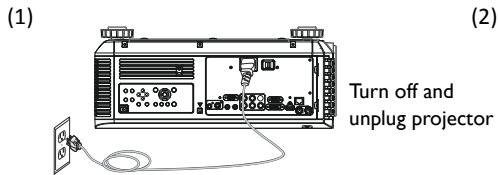

Replacing the filters

It is recommended that you clean the filters every 250 hours (or as needed depending on your room environment) and replace the filters at the same time as you replace the lamps. Follow the instructions below.

- 1 Turn the projector off and unplug the power cord. Wait 60 minutes to allow the projector to cool thoroughly.
- 2 Press the release levers on the filter cover (located on the front corner of the projector) and swing the cover to remove it. Repeat for the filter cover located on the opposite front corner.
- 3 Gently pull out each filter, noting the orientation of each. Replace with the new filters which come with your replacement lamp modules or vacuum the existing filters (and the area around the filter covers) carefully. Note: If the filters are damaged or heavily soiled, they must be replaced.
- 4 Gently re-insert the filters into the filter slots, making sure that the Air Flow arrows are pointed towards the projector intake vents. Replace the filter covers by aligning the hinges and pressing the covers closed.
- 5 Plug in the power cord, turn on the power switch and press the **Power** button to turn the projector back on. Note: Connection to a circuit with a minimum of 20A capacity is recommended.

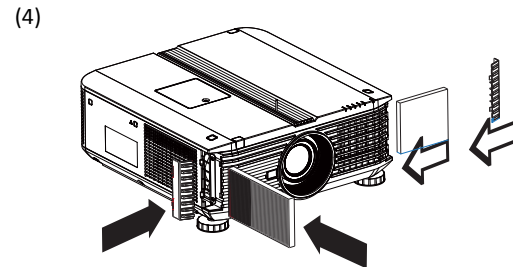
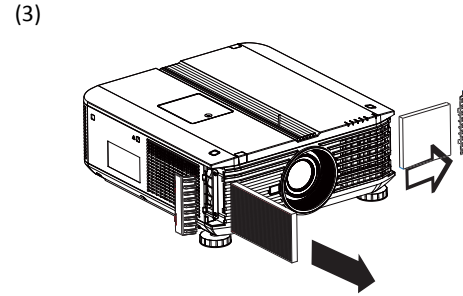
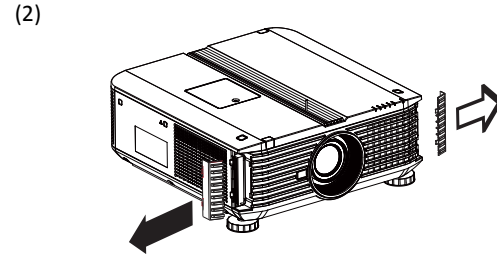
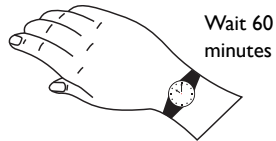
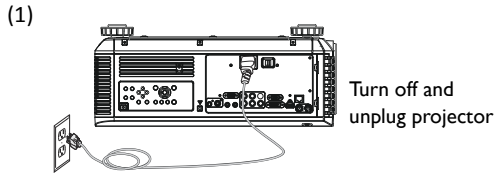

Replacing the color wheel

The color wheel of your projector is user replaceable. The color wheel which was installed by the factory is designed for maximum color brightness and has 6 color segments (RYGCWB). The optional color wheel which came as an accessory is designed for fully saturated color and contains 6 color segments (RGBCMY). Follow the instructions below to replace your color wheel.

- 1 Turn the projector off and unplug the power cord.
- 2 Wait 60 minutes to allow the projector to cool thoroughly.
- 3 Loosen the captive screw on the color wheel cover and lift the door up.
- 4 Loosen the 4 color wheel screws which are marked by arrows.
- 5 Remove the color wheel.
- 6 Align the new color wheel and tighten the 4 captive screws.
- 7 Replace the color wheel cover and tighten the captive screw.
- 8 Plug in the power cord, turn on the power switch and press the **Power** button to turn the projector back on. Note: Connection to a circuit with a minimum of 20A capacity is recommended.

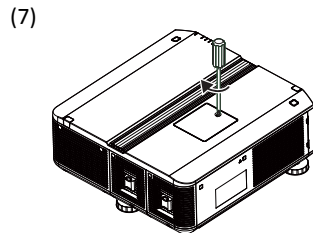
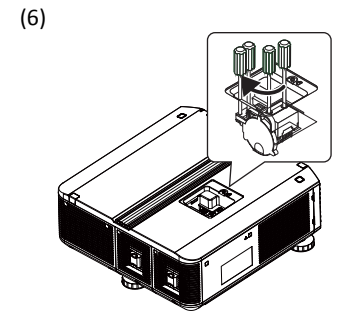
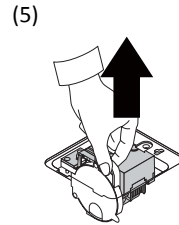
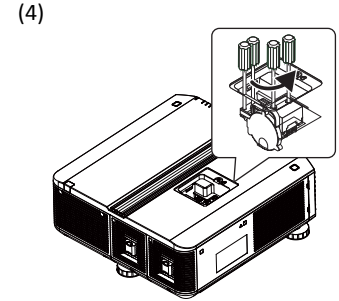
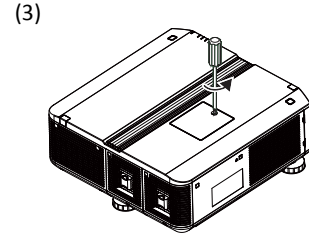
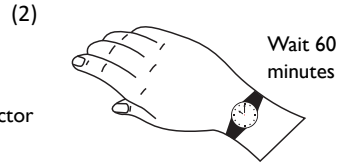
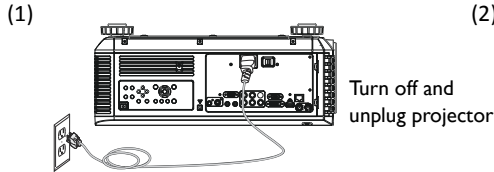

Using the security lock

The projector has a security lock for use with a Cable Lock System. Refer to the information that came with the lock for instructions on how to use it.

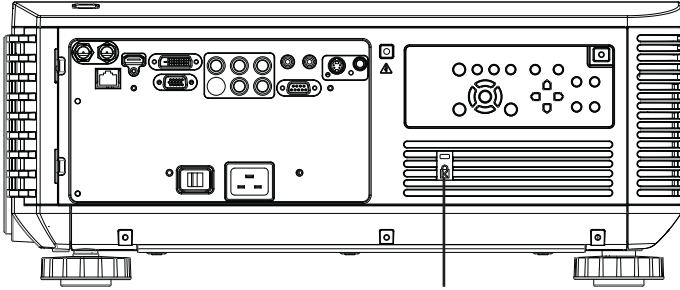

Security lock

Appendix

Optional Lenses

Standard Zoom Lens Features and Specifications (LENS-074):

- Motorized Zoom and Focus

- Lens Shift Position: -20% ~ +60% Vertical; +/-10% Horizontal
- F-Number: 1.7 - 1.9; Focal Length: 26 - 34mm
- Zoom Ratio: 1.3:1
- Throw Distance Ratio: 1.43-1.88:1 (XGA); 1.53-2.02:1 (WXGA); 1.46-1.92:1 (WUXGA).

Standard Zoom Lens		XGA Image Size (Width) +/-10%				WXGA Image Size (Width) +/-10%				WUXGA Image Size (Width) +/-10%			
Throw Distance		Minimum		Maximum		Minimum		Maximum		Minimum		Maximum	
Inch	M	Inch	M	Inch	M	Inch	M	Inch	M	Inch	M	Inch	M
30	.76	15.96	0.41	20.98	0.53	14.85	0.38	19.61	0.50	15.63	0.40	20.55	0.52
36	.91	19.15	0.49	25.17	0.64	17.82	0.45	23.53	0.60	18.75	0.48	24.66	0.63
45	1.14	23.94	0.61	31.47	0.80	22.28	0.57	29.41	0.75	23.44	0.60	30.82	0.78
60	1.52	31.91	0.81	41.96	1.07	29.70	0.75	39.22	1.00	31.25	0.79	41.10	1.04
77	1.96	40.96	1.04	53.85	1.37	38.12	0.97	50.33	1.28	40.10	1.02	52.74	1.34
90	2.29	47.87	1.22	62.94	1.60	44.55	1.13	58.82	1.49	46.88	1.19	61.64	1.57
136	3.45	72.34	1.84	95.10	2.42	67.33	1.71	88.89	2.26	70.83	1.80	93.15	2.37
180	4.57	95.74	2.43	125.87	3.20	89.11	2.26	117.65	2.99	93.75	2.38	123.29	3.13
225	5.72	119.68	3.04	157.34	4.00	111.39	2.83	147.06	3.74	117.19	2.98	154.11	3.91
300	7.62	159.57	4.05	209.79	5.33	148.51	3.77	196.08	4.98	156.25	3.97	205.48	5.22
375	9.53	199.47	5.07	262.24	6.66	185.64	4.72	245.10	6.23	195.31	4.96	256.85	6.52
500	12.70	265.96	6.76	349.65	8.88	247.52	6.29	326.80	8.30	260.42	6.61	342.47	8.70

Wide Fixed Lens Features and Specifications (LENS-075):

- Motorized Focus
- Lens Shift Position: 0%
- F-Number: 1.85

- Focal Length: 11.6mm
- Zoom Ratio: n/a
- Throw Distance Ratio: 0.63:1 (XGA); 0.68:1 (WXGA); 0.64:1 (WUXGA)

Wide Fixed Lens Throw Distance		XGA Image Size (Width) +/-10%		WXGA Image Size (Width) +/-10%		WUXGA Image Size (Width) +/-10%	
Inch	M	Inch	M	Inch	M	Inch	M
30	.76	47.62	1.21	44.12	1.12	46.88	1.19
36	.91	57.14	1.45	52.94	1.34	56.25	1.43
45	1.14	71.43	1.81	66.18	1.68	70.31	1.79
60	1.52	95.24	2.42	88.24	2.24	93.75	2.38
77	1.96	122.22	3.10	113.24	2.88	120.31	3.06
90	2.29	142.86	3.63	132.35	3.36	140.63	3.57
136	3.45	215.87	5.48	200.00	5.08	212.50	5.40
180	4.57	285.71	7.26	264.71	6.72	281.25	7.14
225	5.72	357.14	9.07	330.88	8.40	351.56	8.93
300	7.62	476.19	12.10	441.18	11.21	468.75	11.91
375	9.53	595.24	15.12	551.47	14.01	585.94	14.88
500	12.70	793.65	20.16	735.29	18.68	781.25	19.84

Wide Zoom Lens Features and Specifications (LENS-076):

- Motorized Zoom and Focus
- Lens Shift Position: -20% ~ +60% Vertical; +/-10% Horizontal
- F-Number: 1.85-2.5

- Focal Length: 18.7-26.5mm
- Zoom Ratio: 1.41:1
- Throw Distance Ratio: 1.04-1.48:1 (XGA); 1.11-1.59:1 (WXGA); 1.06-1.72:1 (WUXGA)

Wide Zoom Lens		XGA Image Size (Width) +/-10%				WXGA Image Size (Width) +/-10%				WUXGA Image Size (Width) +/-10%			
Throw Distance		Minimum		Maximum		Minimum		Maximum		Minimum		Maximum	
Inch	M	Inch	M	Inch	M	Inch	M	Inch	M	Inch	M	Inch	M
30	.76	20.27	0.51	28.85	0.73	18.87	0.48	27.03	0.69	19.74	0.50	28.30	0.72
36	.91	24.32	0.62	34.62	0.88	22.64	0.58	32.43	0.82	23.68	0.60	33.96	0.86
45	1.14	30.41	0.77	43.27	1.10	28.30	0.72	40.54	1.03	29.61	0.75	42.45	1.08
60	1.52	40.54	1.03	57.69	1.47	37.74	0.96	54.05	1.37	39.47	1.00	56.60	1.44
77	1.96	52.03	1.32	74.04	1.88	48.43	1.23	69.37	1.76	50.66	1.29	72.64	1.85
90	2.29	60.81	1.54	86.54	2.20	56.60	1.44	81.08	2.06	59.21	1.50	84.91	2.16
136	3.45	91.89	2.33	130.77	3.32	85.53	2.17	122.52	3.11	89.47	2.27	128.30	3.26
180	4.57	121.62	3.09	173.08	4.40	113.21	2.88	162.16	4.12	118.42	3.01	169.81	4.31
225	5.72	152.03	3.86	216.35	5.50	141.51	3.59	202.70	5.15	148.03	3.76	212.26	5.39
300	7.62	202.70	5.15	288.46	7.33	188.68	4.79	270.27	6.86	197.37	5.01	283.02	7.19
375	9.53	253.38	6.44	360.58	9.16	235.85	5.99	337.84	8.58	246.71	6.27	353.77	8.99
500	12.70	337.84	8.58	480.77	12.21	314.47	7.99	450.45	11.44	328.95	8.36	471.70	11.98

Long Zoom I Lens Features and Specifications (LENS-077):

- Motorized Zoom and Focus
- Lens Shift Position: -20% ~ +60% Vertical; +/-10% Horizontal
- F-Number: 1.85 - 2.41
- Focal Length: 52.8-79.1mm
- Zoom Ratio: 1.5:1
- Throw Distance Ratio: 2.97-4.46:1 (XGA); 3.19-4.78:1 (WXGA); 3.04-4.56:1 (WUXGA)
- Adds .3" (8.4mm) to the total length of the projector.

Long Zoom I Lens		XGA Image Size (Width) +/-10%				WXGA Image Size (Width) +/-10%				WUXGA Image Size (Width) +/-10%			
Throw Distance		Minimum		Maximum		Minimum		Maximum		Minimum		Maximum	
Inch	M	Inch	M	Inch	M	Inch	M	Inch	M	Inch	M	Inch	M
30	.76	6.73	0.17	10.10	0.26	6.28	0.16	9.40	0.24	6.58	0.17	9.87	0.25
36	.91	8.07	0.21	12.12	0.31	7.53	0.19	11.29	0.29	7.89	0.20	11.84	0.30
45	1.14	10.09	0.26	15.15	0.38	9.41	0.24	14.11	0.36	9.87	0.25	14.80	0.38
60	1.52	13.45	0.34	20.20	0.51	12.55	0.32	18.81	0.48	13.16	0.33	19.74	0.50
77	1.96	17.26	0.44	25.93	0.66	16.11	0.41	24.14	0.61	16.89	0.43	25.33	0.64
90	2.29	20.18	0.51	30.30	0.77	18.83	0.48	28.21	0.72	19.74	0.50	29.61	0.75
136	3.45	30.49	0.77	45.79	1.16	28.45	0.72	42.63	1.08	29.82	0.76	44.74	1.14
180	4.57	40.36	1.03	60.61	1.54	37.66	0.96	56.43	1.43	39.47	1.00	59.21	1.50
225	5.72	50.45	1.28	75.76	1.92	47.07	1.20	70.53	1.79	49.34	1.25	74.01	1.88
300	7.62	67.26	1.71	101.01	2.57	62.76	1.59	94.04	2.39	65.79	1.67	98.68	2.51
375	9.53	84.08	2.14	126.26	3.21	78.45	1.99	117.55	2.99	82.24	2.09	123.36	3.13
500	12.70	112.11	2.85	168.35	4.28	104.60	2.66	156.74	3.98	109.65	2.79	164.47	4.18

Long Zoom 2 Lens Features and Specifications (LENS-078):

- Motorized Zoom and Focus
- Lens Shift Position: -20% ~ +60% Vertical; +/-10% Horizontal
- F-Number: 1.85 - 2.48
- Focal Length: 78.5-121.9mm
- Zoom Ratio: 1.55:1
- Throw Distance Ratio: 4.4-6.85:1 (XGA); 4.71-7.26:1 (WXGA); 4.50-7.00:1 (WUXGA)
- Adds 1.93" (48.9mm) to the total length of the projector.

Long Zoom 2 Lens		XGA Image Size (Width) +/-10%				WXGA Image Size (Width) +/-10%				WUXGA Image Size (Width) +/-10%			
Throw Distance		Minimum		Maximum		Minimum		Maximum		Minimum		Maximum	
Inch	M	Inch	M	Inch	M	Inch	M	Inch	M	Inch	M	Inch	M
30	.76	4.38	0.11	6.82	0.17	4.13	0.10	6.37	0.16	4.29	0.11	6.67	0.17
36	.91	5.26	0.13	8.18	0.21	4.96	0.13	7.64	0.19	5.14	0.13	8.00	0.20
45	1.14	6.57	0.17	10.23	0.26	6.20	0.16	9.55	0.24	6.43	0.16	10.00	0.25
60	1.52	8.76	0.22	13.64	0.35	8.26	0.21	12.74	0.32	8.57	0.22	13.33	0.34
77	1.96	11.24	0.29	17.50	0.44	10.61	0.27	16.35	0.42	11.00	0.28	17.11	0.43
90	2.29	13.14	0.33	20.45	0.52	12.40	0.31	19.11	0.49	12.86	0.33	20.00	0.51
136	3.45	19.85	0.50	30.91	0.79	18.73	0.48	28.87	0.73	19.43	0.49	30.22	0.77
180	4.57	26.28	0.67	40.91	1.04	24.79	0.63	38.22	0.97	25.71	0.65	40.00	1.02
225	5.72	32.85	0.83	51.14	1.30	30.99	0.79	47.77	1.21	32.14	0.82	50.00	1.27
300	7.62	43.80	1.11	68.18	1.73	41.32	1.05	63.69	1.62	42.86	1.09	66.67	1.69
375	9.53	54.74	1.39	85.23	2.16	51.65	1.31	79.62	2.02	53.57	1.36	83.33	2.12
500	12.70	72.99	1.85	113.64	2.89	68.87	1.75	106.16	2.70	71.43	1.81	111.11	2.82

Semi Long Zoom Lens Features and Specifications (LENS-079):

- Motorized Zoom and Focus
- Lens Shift Position: -20% ~ +60% Vertical; +/-10% Horizontal
- F-Number: 1.86-2.48

- Focal Length: 32.9-54.2mm
- Zoom Ratio: 1.65:1
- Throw Distance Ratio: 1.84-3.05 (XGA); 1.98-3.27:1 (WXGA); 1.88-3.11:1 (WUXGA)

Semi Long Zoom Lens		XGA Image Size (Width) +/-10%				WXGA Image Size (Width) +/-10%				WUXGA Image Size (Width) +/-10%			
Throw Distance		Minimum		Maximum		Minimum		Maximum		Minimum		Maximum	
Inch	M	Inch	M	Inch	M	Inch	M	Inch	M	Inch	M	Inch	M
30	.76	9.84	0.25	16.30	0.41	9.17	0.23	15.15	0.38	9.65	0.25	15.96	0.41
36	.91	11.80	0.30	19.57	0.50	11.01	0.28	18.18	0.46	11.58	0.29	19.15	0.49
45	1.14	14.75	0.37	24.46	0.62	13.76	0.35	22.73	0.58	14.47	0.37	23.94	0.61
60	1.52	19.67	0.50	32.61	0.83	18.35	0.47	30.30	0.77	19.29	0.49	31.91	0.81
77	1.96	25.25	0.64	41.85	1.06	23.55	0.60	38.89	0.99	24.76	0.63	40.96	1.04
90	2.29	29.51	0.75	48.91	1.24	27.52	0.70	45.45	1.15	28.94	0.74	47.87	1.22
136	3.45	44.59	1.13	73.91	1.88	41.59	1.06	68.69	1.74	43.73	1.11	72.34	1.84
180	4.57	59.02	1.50	97.83	2.48	55.05	1.40	90.91	2.31	57.88	1.47	95.74	2.43
225	5.72	73.77	1.87	122.28	3.11	68.81	1.75	113.64	2.89	72.35	1.84	119.68	3.04
300	7.62	98.36	2.50	163.04	4.14	91.74	2.33	151.52	3.85	96.46	2.45	159.57	4.05
375	9.53	122.95	3.12	203.80	5.18	114.68	2.91	189.39	4.81	120.58	3.06	199.47	5.07
500	12.70	163.93	4.16	271.74	6.90	152.91	3.88	252.53	6.41	160.77	4.08	265.96	6.76

PiP Compatibility

PiP allows two distinct sources to be displayed simultaneously. Switch primary sources, make picture adjustments and choose one of multiple display options: either two side by side horizontal or vertical source regions, or a small secondary

source image displayed on top of the primary source in one of four placement options. See page 24 for details. The following source combinations (marked with an "X") are supported:

	HDMI	DVI	RGB	BNC	S-video	Composite	SDI
HDMI			X	X	X	X	
DVI			X	X	X	X	
RGB	X	X			X	X	X
BNC	X	X			X	X	X
S-video	X	X	X	X			X
Composite	X	X	X	X			X
SDI			X	X	X	X	

Control commands

IMPORTANT: When formatting commands sent from a control system or computer, enclose commands in parentheses "(" and ")".

Serial Communication Configuration

Visit our website for additional RS-232 settings and information.

To control this projector via RS-232, connect a straight through cable and set the control system serial port settings to match the following communication configuration:

RS-232 Port Settings	
Setting	Value
Bits per second	38,400
Data bits	8
Parity	None
Stop bits	1
Flow control	None
Emulation	VT100

Network Communication Configuration

For network control, you can access the projector through Port 23 (Telnet).

We use the same control codes on serial as we do over the network. InFocus network control uses the Telnet packet structure.

Command Format

All commands consist of 3 alpha characters followed by a request, all enclosed in parentheses. The request can be a read request (indicated by a "?") or a write request (indicated by 1 to 4 ASCII digits).

A read request example:

(AAA?) where
(starts the command
AAA denotes the command
? denotes the read request
) ends the command

A read command returns the range and the current setting, for example:

Read Command Examples		
Function	Command	Response
Brightness	(BRT?)	(0-200, 100)
Lamp Hours	(LMP?)	(0-32766, 42)

A write request example:

(AAA####) where
(starts the command
AAA denotes the command
denotes the value to be written
(leading zeros not necessary)
) ends the command

Some commands have ranges, while others are absolute. If a number greater than the maximum range is received, it is automatically set to the maximum number for that function. If a command is received that is not understood, a "?" is returned. With absolute settings, "0" is off, 1-9999 is on. The one exception is the Power command, where 0 is off and 1 is on.

To assure the projector can process a command, wait 3 seconds before entering the next command.

Write Command Examples		
Function	Command	Response
Brightness	(BRT100)	Sets the brightness to 100
Power	(PWR0)	Turns power off
Power	(PWR1)	Turns power on

Error Conditions

Not all commands are supported for all projectors. If an unsupported command is issued, the command will be ignored. If a command is received that is not understood, a '?' character will be returned indicating the command was not understood.

Limitations

The projector cannot respond to commands coming in at a high-rate. Therefore, a delay must occur between commands to ensure that the command gets properly executed. To assure the projector can process a command, wait 3 seconds before entering the next command.

Function	Com mand	RW	Min	Max	Default	Step
AC Power On 0: Disable; 1: Enable	APO	RW	0	1	0	1
Active Source 0: HDMI 1: DVI 2: VGA 3: Component / BNC 4: Composite 5: S-Video 6: 3G-SDI	SRA	RW	0	6	0	1
Aspect Ratio 0: 5:4 1: 4:3 2: 16:10 3: 16:9 4: 1.8 5: 2.35 6: Letterbox 7: Native 8: Unscaled	AZT	RW	0	8	2	1
Auto Off Time 0: Off (never) 1: On (20 minutes)	AOT	RW	0	1	0	1

Auto Source 0: Disable; 1: Enable	ASC	RW	0	1	0	1
Auto Sync 0: Off 1: On	AIM	W	0	1	1	1
Blank Bottom	BBO	RW	0	360	0	1
Blank Left	BLE	RW	0	534	0	1
Blank Reset 1: Reset	BRS	W		1		
Blank Right	BRI	RW	0	534	0	1
Blank Screen 0: Disable; 1: Enable	BLK	RW	0	1	0	1
Blank Top	BTO	RW	0	360	0	1
Blue Gain	BCG	RW	0	200	100	1
Blue Offset	BCO	RW	0	200	100	1
Blue Only 0: Off 1: On	BON	RW	0	1	0	1
Brightness	BRT	RW	0	200	100	1
Center Lens 1: Center Lens	MHC	W		1		
Color	COL	RW	0	200	100	1
Color Space 0: Auto 1: YCbCr (REC709) 2: YPbPr (REC601) 3: RGB-PC (0-255) 4: RGB-Video (16-235)	CSM	RW	0	4	0	1

Color Temp 0: 5000K (Warmest) 2: 6500K (Warm) 3: 7800K 4: 9300K (Cool) 5: Native (Bright)	TMP	RW	0	5	Source Specific	I
Contrast	CON	RW	0	200	100	I
Custom Lamp Power	CLP	RW	0	25		I
DHCP Enable 0: Disable; 1: Enable	DHP	RW	0	1	0	I
Dual Lamp Mode 0: Single lamp 1: Both lamps	DLI	RW	0	1	1	I
Dynamic Black 0: Off 1: On	DYB	RW	0	1	0	I
Dynamic Contrast 0: Off 1: On	DYC	RW	0	1	0	I
Edge Blend Alignment Pattern 0: Off 1: On	EBL	RW	0	1	0	I
Edge Blend All	EBA	RW	0	32	0	I
Edge Blend Black Level Uplift Bottom	EUB	RW	0	0,8,1 6,24, 32	0	I
Edge Blend Black Level Uplift Left	EUL	RW	0	0,4,8, 12,16 ,20,2 4,28, 32	0	I

Edge Blend Black Level Uplift Right	EUR	RW	0	0,4,8, 12,16 ,20,2 4,28, 32	0	I
Edge Blend Black Level Uplift Top	EUT	RW	0	0,8,1 6,24, 32	0	I
Edge Blend Blue	EBB	RW	0	32	0	I
Edge Blend Green	EBG	RW	0	32	0	I
Edge Blend Red	EBR	RW	0	32	0	I
Edge Blend Reset	EBZ	W		1		
Edge Blend Status 0: Edge Blending Off 1: Edge Blending On	EBS	RW	0	1	0	I
Edge Blend Width Left	EWL	RW	0	0,200 - 800	0	I
Edge Blend Width Right	EWR	RW	0	0,200 - 800	0	I
Edge Blend Width Top	EWT	RW	0	0,200 - 500	0	I
Edge Blend Width Bottom	EWB	RW	0	0,200 - 500	0	I

Error Condition 0: No error 1: Lamp not lit after 5 attempts 3: Lamp went out unexpectedly 4: Fan failure 5: Overtemperature 6: Low voltage ?: Query	ERR	R	0	6	0	I
Factory Reset 1: Reset	RST	W		1		
Fan Position 0: Normal 1: Vertical 2: Down	FNP	RW	0	2	0	I
Firmware Version	FWV	R			string	
Focus Far 0: Fine Step 1: Large Step	MFF	W	0	1	1	I
Focus Near 0: Fine Step 1: Large Step	MFN	W	0	1	1	I
Gamma 0: Film 1: Graphics 2: Video 3: Linear	GTB	RW	0	3	Source Specific	I
Gateway Address GT1: 1st Octet GT2: 2nd Octet GT3: 3rd Octet GT4: 4th Octet	GT n	RW	0	255	0	I

Green Gain	GCG	RW	0	200	100	I
Green Offset	GCO	RW	0	200	100	I
High Altitude Mode	HAL	RW	0	1	0	I
Horz. Keystone	DHK	RW	-350	350	0	I
Horz. Refresh Rate	QHR	R			string	
Horz. Total	HZT	RW	0	200	100	I
Horz. Position	HPS	RW	0	200	100	I
Horz. Phase	HPH	RW	0	200	100	I
Input Lock 0: Auto 1: 48Hz 2: 50Hz 3: 60Hz	ILC	RW	0	3	0	I
IP Address IP1: 1st Octet IP2: 2nd Octet IP3: 3rd Octet IP4: 4th Octet	IP n	RW	0	255	0	I
Lamp 1 Hours ?: Query	LMP	R	0	n/a	string	I
Lamp 1 Reset 1: Reset	LMR	W		1		
Lamp 1 Status 0: Off 1: On	DLS	R	0	1	1	I
Lamp 2 Hours ?: Query	LDH	R	0	n/a	string	I
Lamp 2 Reset 1: Reset	LDR	W		1		

Lamp 2 Status 0: Off 1: On	DLD	R	0	I	I	I
Lamp Power 0: Eco 1: Normal 2: Dimming	IPM	RW	0	2	I	I
Language 0: English 1: French 2: Spanish 3: German 4: Portuguese 5: Chinese Simplified 6: Korean 7: Arabic 8: Indonesian 9: Italian 10: Norwegian 11: Dutch 12: Swedish 13: Russian 14: Finnish 15: Polish	LAN	RW	0	15	0 (5 for China models)	I
Lens Horizontal Shift Left 0: Fine Step 1: Large Step	MHL	W	0	I		I
Lens Horizontal Shift Right 0: Fine Step 1: Large Step	MHR	W	0	I		I
Lens Memory Load	LLO	W	I	10		I
Lens Memory Save	LSA	W	I	10		I
Lens Vertical Shift Down 0: Fine Step 1: Large Step	MVD	W	0	I		I

Lens Vertical Shift Up 0: Fine Step 1: Large Step	MVU	W	0	I		I
Model	MDL	R			string	
Noise Reduction	NRL	RW	0	200	0	I
Overscan 0: Off; 1: Zoom; 2: Crop	OVS	RW	0	2	0	I
Picture-in-Picture Enable 0: PIP disable 1: PIP enable	SSC	RW	0	I	0	I
Picture-in-Picture Position 0: Top Left 1: Top Right 2: Bottom Left 3: Bottom Right 4: Split Left/Right	SSY	RW	0	7	0	I
Picture-in-Picture Source 1: HDMI 2: DVI 3: VGA 4: Component / BNC 5: Composite 6: S-Video 7: 3G-SDI	SSL	RW	I	7	Source Specific	
Picture-in-Picture Swap 1: Swap	SSS	W		I		
Pincushion Correction	WPP	RW	-100	100	0	I
Pixel Clock	QPC	R			string	
Power 0: Turn Off; 1: Turn On	PWR	RW	0	I	0	I
Power On Time	LMT	R			string	

Power Saving Mode 0: ECO standby mode 1: Standard standby mode	SPS	RW	0	1	1	1
Presets 0: High Bright 1: Presentation 2: Video	PST	RW	0	2	Source Specific	1
Projection Mode 0: Front 1: Rear 2: Ceiling + Front 3: Ceiling + Rear	CEL	RW	0	3		1
Projector Control 0: RS232 1: Network	PJC	RW	0	1	0	1
Projector ID 1...9: Projector ID 255: Empty ID	RSE	RW	1	255	255	1
Projector Status 0. Initializing Standby 1. Standby 2. Initializing Warmup 3. PreCooling 4. Attempting to strike Lamp 5. Checking Lamp Ignition Status 8. Initializing Image 9. Initializing OSD 10. Displaying Image 11. Initializing Cool-down 12. Cooling down 13. Initializing Error Msg 14. Displaying Error Msg 15. Low-Temp Warmup 16. Initializing DMD	SYS	R	0	17		1

Red Gain	RCG	RW	0	200	100	1
Red Offset	RCO	RW	0	200	100	1
Resolution	RES	R			string	
Rotate Image	WPR	RW	-20	+20	0	1
Search Screen 0: Logo 1: Blue 2: Black 3: White	DSU	RW	0	3	0	1
Serial Number	USN	R			string	
Sharpness	SHP	RW	0	200	0	1
Shutter Close 0: Open 1: Close	SHT	RW	0	1	0	1
Source Select 0: HDMI 1: DVI 2: VGA 3: Component / BNC 4: Composite 5: S-Video 6: 3G-SDI	SRC	RW	0	6	0	1
Startup Screen 0: Off 1: On	SLO	RW	0	1		1
Subnet Address NM1: 1st Octet NM2: 2nd Octet NM3: 3rd Octet NM4: 4th Octet	NMn	RW	0	255	0	1

Test Pattern 0: Color Bar 1: Cross Hatch 2: Burst 3: Red 4: Green 5: Blue 6: White 7: Black 8: Cross Mark 9: Cross Hatch + Mark 10: Red (TI) 11: Green (TI) 12: Blue (TI) 13: HRamp (TI) 14: Off	TPS	RW	0	14	14	1
Tint	TNT	RW	0	200	100	1
Total Projector Time	LMT	R			string	
Trigger Event 0: 5:4 1: 4:3 2: 16:10 3: 16:9 4: 1.88 5: 2.35 6: Letterbox 7: Native 8: Unscaled 9: Auto	SCT	RW	0	9	9	1
Vertical Keystone	DKV	RW	-200	200	0	1
Vertical Position	VPS	RW	0	200	100	1
Vertical Refresh Rate	VPC	R			string	

Video Standard 0: Auto 1: PAL 2: SECAM 3: NTSC	VSU	RW	0	3	0	1
W2 Recover	W2R	W		1		
Warp Bottom Left Corner x	WCX	RW	-192	192	0	1
Warp Bottom Left Corner y	WCY	RW	-120	120	0	1
Warp Bottom Right Corner x	WDX	RW	-192	192	0	1
Warp Bottom Right Corner y	WDY	RW	-120	120	0	1
Warp Reset 1: Reset	WRT	W		1		
Warp Top Left Corner x	WAX	RW	-192	192	0	1
Warp Top Left Corner y	WAY	RW	-120	120	0	1
Warp Top Right Corner x	WBX	RW	-192	192	0	1
Warp Top Right Corner y	WBY	RW	-120	120	0	1
Zoom In 0: Fine Step 1: Large Step	MZI	W	0	1		1
Zoom Out 0: Fine Step 1: Large Step	MZO	W	0	1		1

INDEX

A

- Accessories 4
- Adjusting the image 10
- Alignment menu 27

B

- BNC 8

C

- Cable box 11
- Ceiling mount 7, 27
- Cleaning the lens 34
- Color Wheel, replacement 38
- Component 5, 11
- Composite 5, 11
- Configuring and Controlling the Projector via a Web Browser 30
- Connecting a computer source 8
- Connecting a video device 11
- Connecting power 8
- Connector panel 5
- Connectors
 - Component 11
 - Composite 5, 11
 - DVI-D 5, 8
 - HDMI 5, 8, 11
 - LAN 5
 - Power 8
 - RGB (VGA) 5, 8, 11
 - RGBHV 5, 8
 - RS-232 5
 - SDI 5, 11
 - SDI Out 11
 - S-video 5, 11
 - Wired remote jack 5

YPbPr 5

- Control commands 47
- Control menu 28
- Control panel 22

D

- Displaying an image 9
- DVI-D 5, 8

F

- Focus 10, 20, 22

G

- G3-SDI 11
- G3-SDI Out 11

H

- HDMI 5, 8, 11
- High altitude feature 26

I

- Image offset 6
- Image size charts 40–45
- Input menu 24

K

- Keypad buttons 22

L

- Lamp timer reset 35
- Lamp, replacement 34
- Lamps menu 26
- LAN 5
- Laptop port activation 9
- LED indicators 12
- Lens replacement 36

Lens shift 10, 20, 22
Lens, cleaning 34
Lenses, optional 40–45

M

Maintenance 34–38
Menu system (OSD) 23

N

Network communication configuration 47
Network functions 30

O

Optimizing computer image 23
Optional lenses 40–45

P

Picture menu 25
PiP (Picture-in-Picture) feature 24
PiP compatibility 46
Positioning the projector 6
Power connection 8
Product specifications 4
Projection mode 27

R

Rear projection 27
Remote control 20
Replacing the color wheel 38
Replacing the filters 37
Replacing the lens 36
Replacing the projection lamp 34
Reset the lamp timer 35
RGB 5, 11
RGBHV 5, 8
RS-232 commands 47

RS-232 connector 5

S

Screen trigger 5, 28
SDI 5
Security lock 39
Serial communication configuration 47
Serial control 5
Service menu 29
Shutter 20, 22
Shutting down the projector 12
S-video 5, 11

T

Troubleshooting
 Embedded video does not play on screen 18
 Image does not fit the screen 16
 Image fuzzy or cropped 15
 Image not centered on screen 15
 Image not sharp 16
 Image not square 16
 Image reversed left to right 17
 Image upside down 17
 Lamp won't turn on 18, 19
 LED indicators 12
 Network Functions 33
 No start up screen 13
 Only "Signal out of range" message 14
 Only laptop background displays - no Desktop icons 14
 Only the start up screen appears 13
 Projected colors don't match source 17
 Remote 21
Tuners 11

U

USB 8

Using network functions 30
Using the remote control 20

V

VGA 5, 8, 11
Video device connections 11

W

Warranty 19
Wired remote 5, 21

Y

YPbPr 5

Z

Zoom 10, 20, 22