

Lenovo Yoga S730-13IWL User Guide



Read the safety notices and important tips in the included manuals before using your computer.



Notes

- Before using the product, be sure to read *Lenovo Safety and General Information Guide* first.
- The latest *Safety and Warranty Guide*, *Setup Guide*, and *Regulatory Notice* are available on the Lenovo Support Web site at: <https://support.lenovo.com>.
- The latest electronic compliance information and environmental declarations are available from the Lenovo compliance information Web sites.
 - To view compliance information, go to: <https://www.lenovo.com/compliance>.
 - To download environmental information, go to: <https://www.lenovo.com/ecodeclaration>.
- Some instructions in this guide may assume that you are using Windows® 10. If you are using another Windows operating system, some operations may be slightly different. If you are using other operating systems, some operations may not apply to you.
- The features described in this guide are common to most models. Some features may not be available on your computer or your computer may include features that are not described in this user guide.
- Microsoft® makes periodic feature changes to the Windows operating system through Windows Update. As a result, some information in this guide may become outdated. Refer to Microsoft resources for the latest information.
- The illustrations in this manual may differ from the actual product. Please refer to the actual product.

First Edition (July 2018)

© Copyright Lenovo 2018.

LIMITED AND RESTRICTED RIGHTS NOTICE: If data or software is delivered pursuant to a General Services Administration "GSA" contract, use, reproduction, or disclosure is subject to restrictions set forth in Contract No. GS-35F-05925.

Contents

Chapter 1. Getting to know your computer	1
Top view	1
Left-side view	3
Right-side view	4
Bottom view	5
Status indicators	6
Chapter 2. Starting to use your computer	8
Microsoft resources for Windows	8
Windows 10 desktop components	9
Putting the computer to sleep or shutting it down	11
Connecting to a wireless network	12
Using the keyboard	13
Chapter 3. Recovering or restoring Windows	16
Restoring from a system restore point	17
Resetting your computer	18
Using a recovery drive to restore or recover Windows	19
Chapter 4. Troubleshooting	20
Display problems	20
Sleep problems	21
Battery pack problems	22
Sound problems	22
Other problems	22
Trademarks	24

Chapter 1. Getting to know your computer

■ ■ Top view

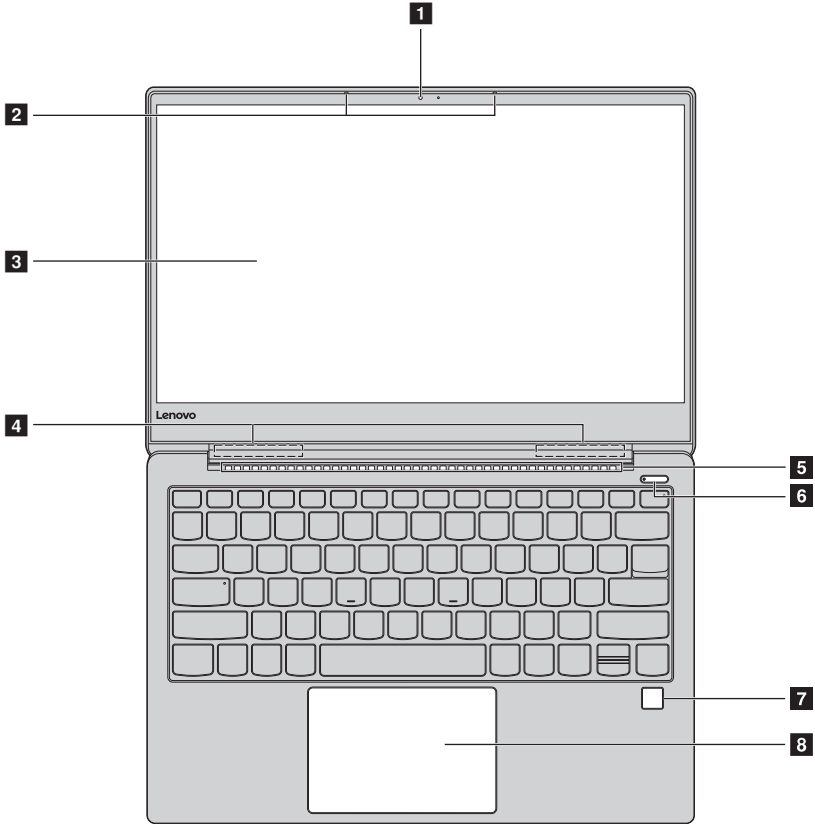

Figure 1. Top view - Lenovo Yoga S730-13IWL

Note: The dashed areas indicate parts that are not visible externally.

⦿ Attention:

- Do *not* open the display panel beyond 180 degrees. When closing the display panel, be careful *not* to leave pens or any other objects between the display panel and the keyboard. Otherwise, the display panel may be damaged.

Chapter 1. Getting to know your computer

- 1 Integrated camera** The integrated camera can be used for video conferencing.
- 2 Built-in microphone** Capture sound for video conferencing, voice narration, or audio recording.
- 3 Computer display** The LCD display with LED backlight provides brilliant visual output.
- 4 Wireless LAN antennas** The wireless antennas are connected with the built-in wireless adapter to send and receive wireless radio signals.
- 5 Ventilation slots** Dissipate internal heat.
- 6 Power button** Press this button to turn on the computer.
When Windows is running, press the Power button to put the computer into sleep mode.
- 7 Fingerprint reader** Registers fingerprints that can be used as passwords to secure your computer.
- 8 Touch pad and click buttons** The touch pad functions as a conventional mouse.
Touch pad: To move the pointer on the screen, slide your fingertip over the pad in the direction in which you want the pointer to move.
Click buttons: The functions of the Click buttons correspond to those of the left and right mouse buttons on a computer mouse.

Note: You can enable/disable the touch pad by pressing **F6** ()

■ ■ Left-side view

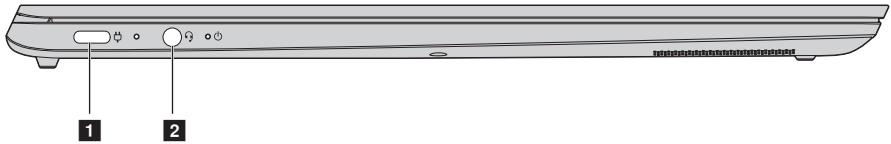

Figure 2. Left-side view - Lenovo Yoga S730-13IWL

- | | | |
|----------|--|--|
| 1 | ac power adapter jack/Type-C port | This jack can be used as both ac power adapter jack and Type-C port, supporting USB 3.1. |
| 2 | Combo audio jack | Connects to headsets. |

Notes:

- The combo audio jack does not support conventional microphones.
- The recording function may not be supported if third-party headphones or headsets are connected, due to different industry standards.

Chapter 1. Getting to know your computer

■ ■ Right-side view

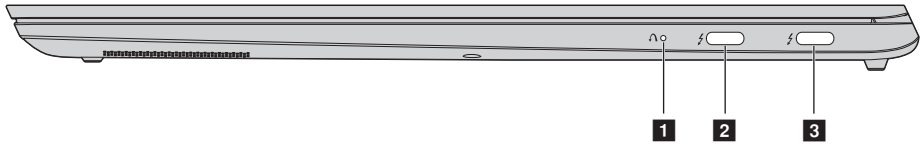

Figure 3. Right-side view - Lenovo Yoga S730-13IWL

1 Novo button

When the computer is off, press this button to start the System Recovery or the BIOS setup utility, or to enter the boot menu.

2 USB (Type-C) / port

3

The USB (Type-C) connectors support both the USB Type-C™ standard and Thunderbolt™ 3 technology. With a compatible USB-C cable, you can use this connector to transfer data, charge your device, or connect your computer to external displays. Both connectors are also compatible with DisplayPort® standard: this means you can connect a high-performance monitor, or other devices that use a DisplayPort connector.

Note: Port **2** has the “Always On USB” feature, which allows you to charge your external devices even when your computer is turned off.

■ ■ **Bottom view**

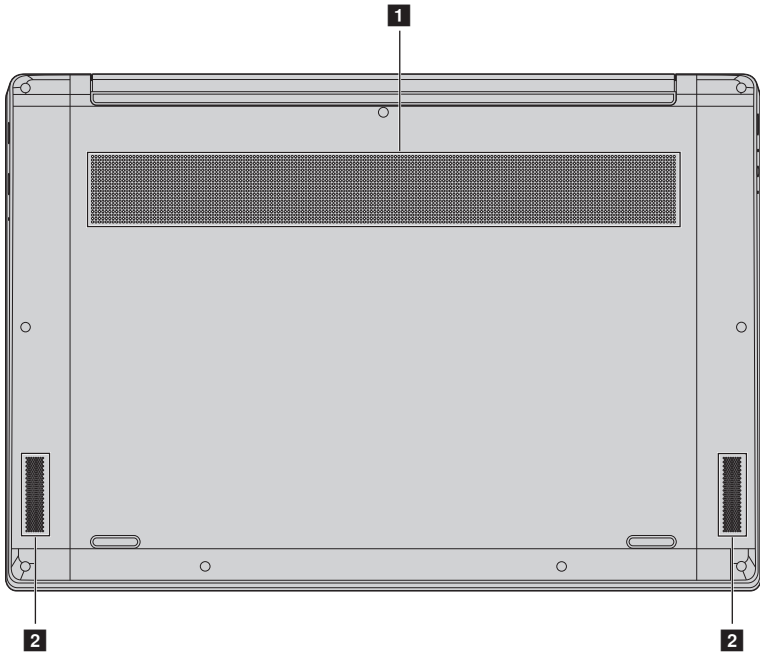

Figure 4. Bottom view - Lenovo Yoga S730-13IWL

1 Ventilation slots Dissipate internal heat.

Note: Make sure that none of the ventilation slots are blocked, or else overheating of the computer may occur.

2 Speakers Provide audio output.

Chapter 1. Getting to know your computer

■ ■ Status indicators

This section helps you locate and identify the various status indicators on your computer.

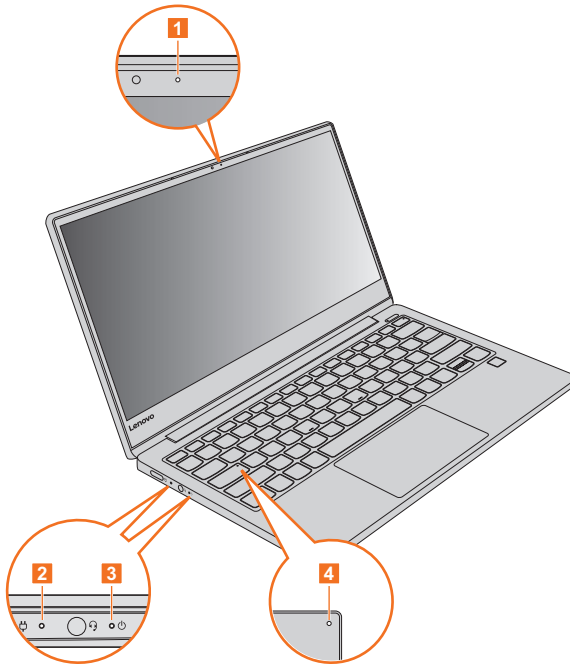

Figure 5. Indicators - Lenovo Yoga S730-13IWL

- 1** **Camera status indicator** When this indicator is on, the camera is in use.

2 Battery/Charging status indicator

ac power adapter status	Indicator status	Meaning
Disconnected	Off	The battery is not charging.
	Solid amber	The battery has between 1% and 90% charge and is still charging.
Connected	Solid white	The battery has more than 90% charge, charging will continue until the battery is fully charged.

3 Power status indicator

Indicator	Indicator status	Meaning
Power status indicator	On (solid white)	The computer is powered on and the battery has between 21% and 100% charge.
	On (solid amber)	The computer is powered on and the battery has between 1% and 20% charge.
	Slow blinking amber	The computer is in sleep mode and the battery has between 1% and 20% charge.
	Slow blinking white	The computer is in sleep mode and the battery has between 21% and 100% charge.
	Off	The computer is powered off.

4 Caps Lock indicator

When this indicator is on, you can type uppercase letters directly.

Chapter 2. Starting to use your computer

■ ■ Microsoft resources for Windows ---







Microsoft provides a comprehensive set of information about Windows.

- The preinstalled **Tips** app provides new features and tips for Windows. You can start the **Tips** app by typing “Tips” in the search box of your Windows desktop and selecting the matching results.
- The preinstalled **Get Help** app provides support and assistance for using Windows. You can start the **Get Help** app by typing “Get Help” in the search box of your Windows desktop and selecting the matching result. You must be connected to the Internet to use the **Get Help** app.
- The Microsoft support Web site <https://support.microsoft.com/> provides comprehensive helpful information about Windows.

Windows 10 desktop components



Figure 6. Windows 10 desktop

- | | |
|--|--|
| 1 Settings button  | 2 Power button  |
| 3 Start button  | 4 Search box  |
| 5 Task view button  | 6 Wireless status icon  |
| 7 Battery status icon  | 8 Action center  |

Settings button

Settings lets you perform basic tasks. You can also search for more settings using the settings search box.



Battery status icon

You can move your pointer to this icon to check the battery status. The battery status icon displays the percentage of battery power remaining and how long you can use your computer before you must charge the battery.

Chapter 2. Starting to use your computer

Wireless status icon

This icon shows the status of your computer's wireless connection.

-  Your computer is not connected to any wireless network.
-  Your computer is connected to a wireless network.
-  Airplane mode is on.

Action center

Here you can find important notifications from Windows and your apps. You can also change common settings quickly.

■ ■ Putting the computer to sleep or shutting it down

When you have finished working with your computer, you can put it to sleep or shut it down.

■ Putting your computer to sleep

When the computer is in sleep mode, you can quickly wake it to resume use, bypassing the startup process.

To put the computer to sleep, do one of the following:

- Close the display lid.
- Press and hold the power button for 1 second.
- Move the cursor to the lower-left corner, and then select the Start button.

Select **Power**  → **Sleep**.

Note: Put your computer to sleep before you move it. Moving your computer while the hard disk drive is spinning can damage the hard disk, causing loss of data.

To wake up the computer, do one of the following:

- Press any key on the keyboard.
- Press the power button.

■ Shutting down the computer

If you are not going to use your computer for a long time, shut it down.

To shut down your computer, do one of the following:

- Move the cursor to the lower-left corner, and then select the Start button.

Select **Power**  → **Shut down**.

- Right-click the Start button in the lower-left corner and select **Shut down or sign out** → **Shut down**.

Chapter 2. Starting to use your computer

■ ■ Connecting to a wireless network

Wireless connection is the transfer of data using radio waves instead of cables.

■ Connecting to a Wi-Fi network

Your computer comes with a built-in Wi-Fi network card to help you establish wireless connections and monitor connection status.

① Click the wireless icon in the notification area.

Note: If the wireless icon is not displayed, airplane mode may be turned on.

② Select the network name you want to connect to and click **Connect**.

③ Enter the security key when prompted and click **Next**.

■ Turning on/off airplane mode

- Press **F7** on the keyboard.
- Click **Start** → **Settings** → **Network & Internet** → **Airplane mode**. Slide the toggle for Airplane mode to turn it on or off.
- In action center, click the **Airplane mode** button to turn it on or off.

Using the keyboard

Hotkeys

Some keys on the keyboard are printed with symbols. These keys are called hotkeys and can be pressed alone to change certain settings quickly.

Note: Some hotkeys share keys with function keys (F1 to F12). If Hotkey mode is set as disabled in the BIOS setup utility, you need to press the Fn key with these hotkeys to access certain settings.

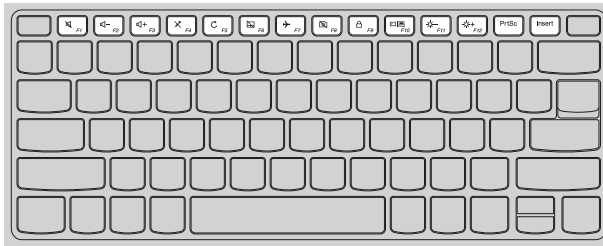
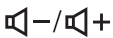

Figure 7. Hotkeys - Lenovo Yoga S730-13IWL

Hotkey	Function
	Mutes/unmutes the sound.
	Decreases/increases the volume level.
	Enables/disables built-in microphones.
	Refreshes page.
	Enables/disables the touch pad.
	Turns on/off airplane mode.
	Enables/disables the integrated camera.
	Locks/unlocks the LCD screen.
	Switches display devices.



Mutes/unmutes the sound.



Decreases/increases the volume level.



Enables/disables built-in microphones.



Refreshes page.



Enables/disables the touch pad.



Turns on/off airplane mode.



Enables/disables the integrated camera.





Locks/unlocks the LCD screen.



Switches display devices.

Chapter 2. Starting to use your computer

Hotkey	Function
 -/ 	Decreases/increases display brightness.
PrtSc	Enables the print screen function.
Insert	Enables the insert function.

Fn + Space: Adjusts the keyboard backlight.

Setting hotkey mode

The **Hotkey Mode** setting in the BIOS setup utility determines whether hotkeys takes precedence over function keys.

- 1 Shut down the computer.
- 2 Press the Novo button and then select **BIOS Setup**.
- 3 In the BIOS setup utility, open the **Configuration** menu, and change the setting of **Hotkey Mode** to **Enabled** or **Disabled**.
- 4 Open the **Exit** menu, and select **Exit Saving Changes**.

Hidden keys

Some character keys on your keyboard can be used with the **Fn** key to enable certain settings. These keys are called hidden keys.

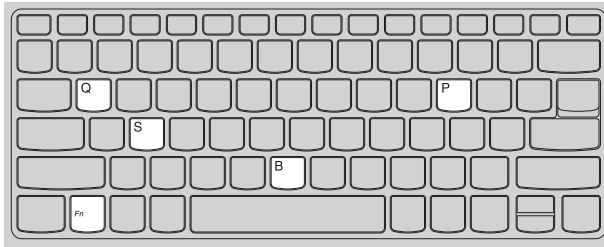

Figure 8. Hidden keys - Lenovo Yoga S730-13IWL

- | | |
|----------------|-------------------------------|
| Fn + B: | Activates the break function. |
| Fn + P: | Activates the pause function. |
| Fn + S: | Activates the system request. |
| Fn + Q: | Activates the Quiet Mode. |

Chapter 3. Recovering or restoring Windows

This chapter provides information about the recovery options for Windows 10.

You may need to recover or restore Windows if you encounter the following situations:

- Your computer cannot start properly.
- Your computer does not work well after installing apps, drivers, or updates.

Windows 10 provides several options for you to recover or restore Windows. The following table helps you decide which option to use if you're having problems with your computer.

Problem	Available options
Your computer isn't working well after installing apps, drivers, or updates.	Restore from a system restore point.
Your computer isn't working well and you don't know what is causing the problem.	Reset your computer.
Windows cannot start properly.	Use a recovery drive to recover or restore your computer.
You want to recycle or donate your computer.	Reset your computer.

■ Restoring from a system restore point

- ➊ In the search box of your Windows desktop, search for Recovery and then select it.
- ➋ Select **Open System Restore** → **Next**.
- ➌ Select a restore point and then select **Next** → **Finish**.

Note: You may select **Scan for affected programs** to check which program and driver installation is associated with a particular restore point.

■ Windows System Restore

System Restore is a tool included in Windows. It monitors changes to Windows system files and saves system state as a restore point. If your computer does not work properly after installing apps, drivers, or updates, you can revert your system to a previous restore point.

Note: Reverting your system to a previous restore point does not affect your personal data.

System Restore creates restore points in three cases:

- automatically when it detects changes to Windows system files
- at regular intervals (if set up by the user)
- at any time by the user

■ Creating a system restore point manually

You can use Windows System Restore to create a restore point at any time.

- ➊ In the search box of your Windows desktop, search for **Create a restore point** and then select it.
- ➋ Select the **System Protection** tab and then select **Create**.

■ ■ Resetting your computer

If your computer isn't working well and you're not sure why, you can reset your computer.

- ❶ To reset your computer:
 - When the computer is off, press the **Novo** button to open the Novo Menu; select **System Recovery** → **Troubleshoot** → **Reset this PC**.
 - In Windows, go to **Settings** → **Update & security** → **Recovery**; under **Reset this PC**, select **Get Started**.
- ❷ Choose an option.
 - If you want to keep your personal files, select **Keep my files**.
 - Otherwise, select **Remove everything**.

Note: If you're planning to donate, recycle, or sell your PC, use this option and choose to fully clean the drive. This might take an hour or two, but it makes it harder for other people to recover files you've removed.

■ ■ Using a recovery drive to restore or recover Windows

If Windows cannot start properly, you can use a recovery drive (created in advance) to restore or recover Windows.

- ❶ Connect the recovery drive to your computer; restart your computer and set it up to start from the recovery drive.
- ❷ On the **Choose an option** screen, select **Troubleshoot**.
- ❸ Choose a recovery option.
 - Select **Advanced Options** → **System Restore** to restore your computer to a system restore point.
 - Select **Recover from a drive**.

Note: If you did not select the **Back up system files to the recovery drive** option when creating the recovery drive, **Recover from a drive** is not available.

⦿ **Attention:**

- All personal files created on your computer will be deleted after recovering from the drive.

■ Creating a recovery drive

Use a USB drive (not included) to create a recovery drive. You can use it to fix problems with your computer in cases when Windows cannot start properly.

- ❶ In the search box of your Windows 10, search for **Create a recovery drive** and then select it.
- ❷ Make sure **Back up system files to the recovery drive** is selected and then select **Next**.
- ❸ Connect a USB drive to your computer, select it and then select **Next** → **Create**.

⦿ **Attention:**

- If there are personal files on the USB drive, back up all personal files before using it to create a recovery drive.

⦿ **Important:**

- When your recovery drive is created, you might see a **Delete the recovery partition from your PC** option. If you want to free up drive space on your computer, select it and then select **Delete**. Otherwise, select **Finish**.

Chapter 4. Troubleshooting

■ ■ Display problems

■ When I turn on the computer, nothing appears on the screen.

Make sure that:

- The ac power adapter is connected to the computer and plugged into a working electrical outlet.
- The computer power is on. (Press the power button again for confirmation.)
- The brightness level of the screen is appropriately set.

If these items are correctly set, yet the screen remains blank, have the computer serviced.

■ When I turn on the computer, only a white cursor appears on a blank screen.

- Turn off the computer, and then turn it on again.
- If the problem persists, restore backed-up files to your Windows environment or the entire contents of your hard disk to its original factory contents using the Windows recovery system. If you still see only the cursor on the screen, have the computer serviced.

■ The screen goes blank while the computer is on.

Your screen saver or power management may be enabled. Do one of the following to resume from sleep mode:

- Press any key on the keyboard.
- Press the power button.

■ The screen is blank.

Do the following:

- If you are using the ac power adapter or the battery pack, and the battery status indicator shows that the battery is not depleted, press **F12** to make the screen brighter.
- If the system status indicator is blinking, press the power button to resume from sleep mode.
- If the problem persists, follow the solution in the next problem “The screen is unreadable or distorted.”

■ The screen is unreadable or distorted.

Make sure that:

- The screen resolution and color quality are correctly set.
- The monitor type is correct.

■ Incorrect characters appear on the screen.

Are the operating system or programs installed correctly? If they are installed and configured correctly, have the computer serviced.

■ Sleep problems

■ The critical low-battery error message appears, and the computer immediately turns off.

The battery power is getting low. Connect the ac power adapter to the computer.

■ The computer enters sleep mode immediately after Power-on self-test (POST).

Make sure that:

- The battery pack is charged.
- The operating temperature is within the acceptable range. See “Chapter 2. Use and care Information” in the *Lenovo Safety and General Information Guide*.

Note: If the battery pack is charged and the temperature is within range, have the computer serviced.

■ The computer does not resume from sleep mode, and the computer does not work.

- If your computer is in sleep mode, connect the ac power adapter to the computer and then press the power button.
- If the system still does not resume from sleep mode, stops responding, or cannot be turned off, reset the computer. Unsaved data may be lost. To reset the computer, press and hold the power button for eight seconds or more. If the computer is still not reset, remove the ac power adapter.

Chapter 4. Troubleshooting

■ ■ Battery pack problems

■ Battery status icon shows status incorrectly.

Your computer shuts down before the battery status icon shows empty, or your computer continues operating after the battery status icon shows empty.

- Recharge the battery.

■ ■ Sound problems

■ No sound can be heard from the speakers even when the volume is turned up.

Make sure that:

- The Mute function is off.
- The combo audio connector is not being used.
- The speakers are selected as the playback device.

■ ■ Other problems

■ Your computer does not respond.

- To turn off your computer, press and hold the Power button for eight seconds or more. If the computer still does not respond, remove the ac power adapter.
- Your computer might lock when it enters sleep mode during a communication operation. Disable the sleep timer when you are working on the network.
 - To disable the sleep timer, click **Start** → **Settings** → **System** → **Power & sleep**; under Sleep, select **Never** in the pull down menu.

■ A connected external device does not work.

- Do not connect or disconnect any external device cables other than USB while the computer power is on. Otherwise, you might damage your computer.

- When using high power consumption external devices such as an external USB optical disk drive, use an external device power adapter. Otherwise, the device may not be recognized, and the system may shut down as a result.

Trademarks

LENOVO, LENOVO logo, Yoga and the Yoga logo are trademarks of Lenovo. Microsoft, Windows and Cortana are trademarks of the Microsoft group of companies. USB Type-C and USB-C are trademarks of USB Implementers Forum. Thunderbolt is a trademark of Intel Corporation or its subsidiaries in the U. S. and/or other countries. DisplayPort is a trademark of the Video Electronics Standards Association. Wi-Fi is a registered trademark of Wi-Fi Alliance. All other trademarks are the property of their respective owners. © 2018 Lenovo.

