

SAMSUNG

USER MANUAL

7 SERIES

Thank you for purchasing this Samsung product.



To receive more complete service, please register your product at www.samsung.com/register

Model _____ Serial No. _____

Before Reading This User Manual

This TV comes with this user manual and an embedded e-Manual.

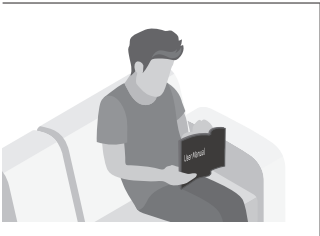
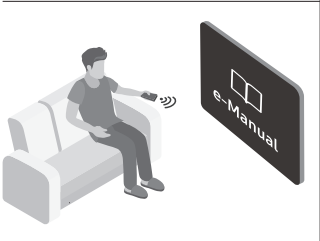

Before reading this user manual, review the following:

	User Manual	Read this provided user manual to see information about product safety, installation, accessories, initial configuration, and product specifications.
	e-Manual	For more information about this TV, read the e-Manual embedded in the product. <ul style="list-style-type: none">To open the e-Manual,  >  Settings > Support > Open e-Manual



On the website, you can download the user manual and see its contents on your PC or mobile device.

Learning the e-Manual's assistance functions

- Some menu screens cannot be accessed from the e-Manual.

	(Search)	Select an item from the search results to load the corresponding page.
	(Index)	Select a keyword to navigate to the relevant page.
	(Recent pages)	Select a topic from the list of recently viewed topics.

Learning the functions of the buttons that appear on e-Manual topic pages

	(Try Now)	Access the associated menu item and try out the feature directly.
	(Link)	Access a topic referred to on an e-Manual topic page.

Features of your new TV

Home Screen

In Home Screen, you can easily run the apps that have been used previously or frequently. The apps can also be moved or deleted in the screen.

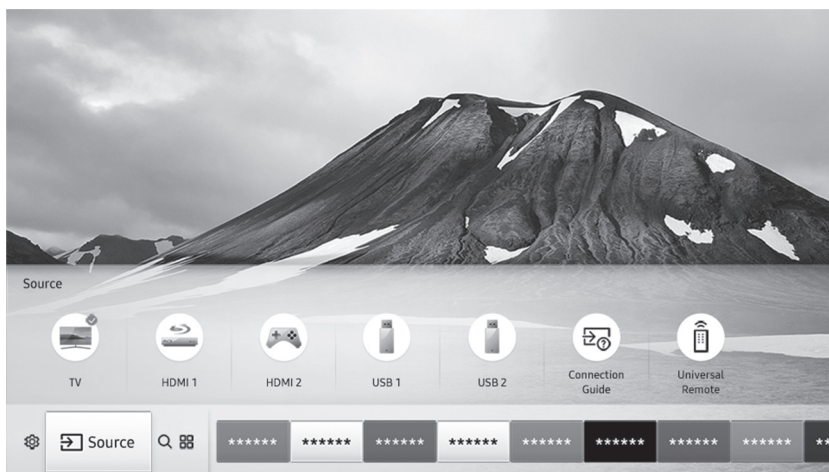

e-Manual

Get help from a detailed, on-screen user's manual built into your TV.







Voice Interaction

Access and control menu options and functions using voice commands.



Warning! Important Safety Instructions

Please read the Safety Instructions before using your TV.

CAUTION			Class II product: This symbol indicates that a safety connection to electrical earth (ground) is not required.
RISK OF ELECTRIC SHOCK. DO NOT OPEN.			
CAUTION: TO REDUCE THE RISK OF ELECTRIC SHOCK, DO NOT REMOVE COVER (OR BACK). THERE ARE NO USER SERVICEABLE PARTS INSIDE. REFER ALL SERVICING TO QUALIFIED PERSONNEL.			AC voltage: Rated voltage marked with this symbol is AC voltage.
	This symbol indicates that high voltage is present inside. It is dangerous to make any kind of contact with any internal part of this product.		DC voltage: Rated voltage marked with this symbol is DC voltage.
	This symbol indicates that this product has included important literature concerning operation and maintenance.		Caution. Consult instructions for use: This symbol instructs the user to consult the user manual for further safety related information.

- The slots and openings in the cabinet and in the back or bottom are provided for necessary ventilation. To ensure reliable operation of this apparatus and to protect it from overheating, these slots and openings must never be blocked or covered.
 - Do not place this apparatus in a confined space, such as a bookcase or built-in cabinet, unless proper ventilation is provided.
 - Do not place this apparatus near or over a radiator or heat register, or where it is exposed to direct sunlight.
 - Do not place vessels (vases etc.) containing water on this apparatus, as this can result in a fire or electric shock.
- Do not expose this apparatus to rain or place it near water (near a bathtub, washbowl, kitchen sink, or laundry tub, in a wet basement, or near a swimming pool, etc.). If this apparatus accidentally gets wet, unplug it and contact an authorised dealer immediately.
- This apparatus uses batteries. In your community, there might be environmental regulations that require you to dispose of these batteries properly. Please contact your local authorities for disposal or recycling information.
- Do not overload wall outlets, extension cords, or adaptors beyond their capacity, since this can result in fire or electric shock.
- Power-supply cords should be placed so that they are not likely to be walked on or pinched by items placed upon or against them. Pay particular attention to cords at the plug end, at wall outlets, and at the point where they exit from the appliance.
- To protect this apparatus from a lightning storm, or when left unattended and unused for long periods of time, unplug it from the wall outlet and disconnect the antenna or cable system. This will prevent damage to the set due to lightning and power line surges.
- Before connecting the AC power cord to the DC adaptor outlet, make sure that the voltage designation of the DC adaptor corresponds to the local electrical supply.
- Never insert anything metallic into the open parts of this apparatus. This may cause a danger of electric shock.

- To avoid electric shock, never touch the inside of this apparatus. Only a qualified technician should open this apparatus.
- Be sure to plug in the power cord until it is firmly seated. When unplugging the power cord from a wall outlet, always pull on the power cord's plug. Never unplug it by pulling on the power cord. Do not touch the power cord with wet hands.
- If this apparatus does not operate normally - in particular, if there are any unusual sounds or smells coming from it - unplug it immediately and contact an authorised dealer or service centre.
- Be sure to pull the power plug out of the outlet if the TV is to remain unused or if you are to leave the house for an extended period of time (especially when children, elderly, or disabled people will be left alone in the house).
 - Accumulated dust can cause an electric shock, an electric leakage, or a fire by causing the power cord to generate sparks and heat or by causing the insulation to deteriorate.
- Be sure to contact an authorised Samsung service centre for information if you intend to install your TV in a location with heavy dust, high or low temperatures, high humidity, chemical substances, or where it will operate 24 hours a day such as in an airport, a train station, etc. Failure to do so may lead to serious damage to your TV.
- Use only a properly grounded plug and wall outlet.
 - An improper ground may cause electric shock or equipment damage. (Class I Equipment only.)
- To turn off this apparatus completely, disconnect it from the wall outlet. To ensure you can unplug this apparatus quickly if necessary, make sure that the wall outlet and power plug are readily accessible.
- Store the accessories (batteries, etc.) in a location safely out of the reach of children.
- Do not drop or strike the product. If the product is damaged, disconnect the power cord and contact a Samsung service centre.
- To clean this apparatus, unplug the power cord from the wall outlet and wipe the product with a soft, dry cloth. Do not use any chemicals such as wax, benzene, alcohol, thinners, insecticide, aerial fresheners, lubricants, or detergents. These chemicals can damage the appearance of the TV or erase the printing on the product.
- Do not expose this apparatus to dripping or splashing.
- Do not dispose of batteries in a fire.
- Do not short-circuit, disassemble, or overheat the batteries.
- There is danger of an explosion if you replace the batteries used in the remote with the wrong type of battery. Replace only with the same or equivalent type.

* The figures and illustrations in this User Manual are provided for reference only and may differ from the actual product appearance. The product design and specifications may change without notice. CIS languages (Russian, Ukrainian, Kazakhs) are not available for this product, since this is manufactured for customers in the EU region.

Contents

Before Reading This User Manual	2
Features of your new TV	3
Warning! Important Safety Instructions	4

01 What's in the Box?

02 Assembling the TV

Attaching the TV to the Stand	10
Mounting the TV on a wall	10
Providing proper ventilation for your TV	12
Safety Precaution: Securing the TV to the wall to prevent falling	12

03 The TV Controller

Using the TV Controller	14
The Standard Remote Control	15
The Samsung Smart Remote	16
Installing batteries into the Samsung Smart Remote	18
About the Samsung Smart Remote	18
Controlling External Devices with the TV Remote - Using the Universal Remote	20

04 Performing the initial setup

Initial setup	21
---------------	----

05 Connections

Connecting devices to your TV	22
Connecting to the Internet	23

06 Selecting Connected Devices

Changing the input signal	24
Editing external devices	24
Using additional functions	24

07 Troubleshooting and Maintenance

Troubleshooting	25
What is Remote Support?	27
Eco Sensor and screen brightness	28
Caring for the TV	28

08 Specifications and Other Information

Specifications	29
Environmental Considerations	29
Decreasing power consumption	30
Licences	30
Still image warning	31
Warranty Card	34
WARRANTY CONDITIONS	34

01 What's in the Box?

Make sure the following items are included with your TV. If any items are missing, contact your dealer.

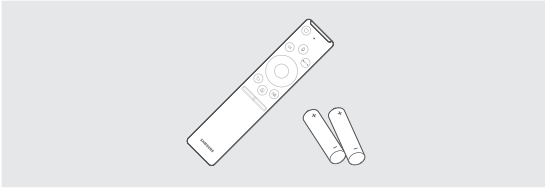

Samsung Smart Remote & Batteries (AA x 2)

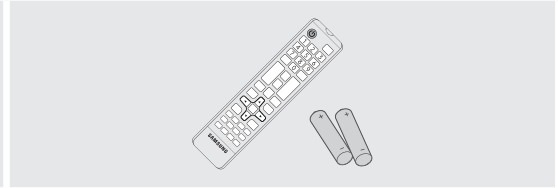

Remote Control & Batteries (AAA x 2)

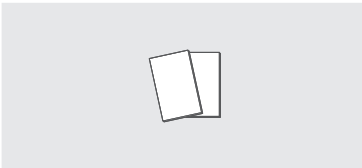

User Manual

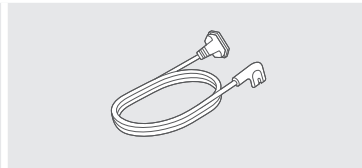

TV Power Cable

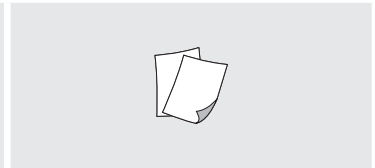

Warranty Card / Regulatory Guide



One Connect / One Connect Cable

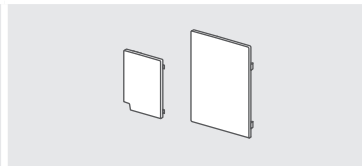

Cover Terminal



Wall Mount Adapter

- The items' colours and shapes may vary depending on the models.
- Cables not included can be purchased separately.
- Check for any accessories hidden behind or in the packing materials when opening the box.

An administration fee may be charged in the following situations:

- (a) An engineer is called out at your request, but there will be no defect with the product (i.e., where the user manual has not been read).
- (b) You bring the unit to a repair centre, but there will be no defect identified the product (i.e., where the user manual has not been read).

You will be informed of the administration fee amount before a technician visits.



Warning: Screens can be damaged from direct pressure when handled incorrectly. We recommend lifting the TV at the edges, as shown.

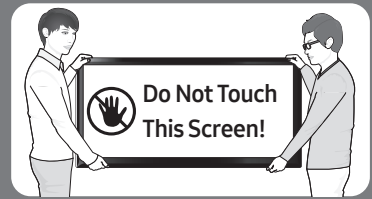

02 Assembling the TV

Attaching the TV to the Stand

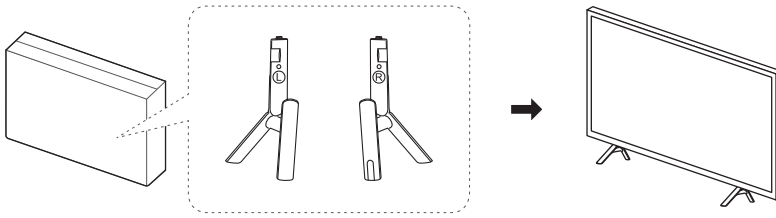

Make sure you have all the accessories shown, and that you assemble the stand following the provided assembly instructions.

Mounting the TV on a wall



If you mount this TV on a wall, follow the instructions exactly as set out by the manufacturer. Unless it is correctly mounted, the TV may slide or fall and cause serious injury to a child or adult and serious damage to the TV.

For models providing wall mount adapters, install them as shown in the figure below before installing the wall mount kit.

- Refer to the installation manual included with the Samsung wall mount kit.

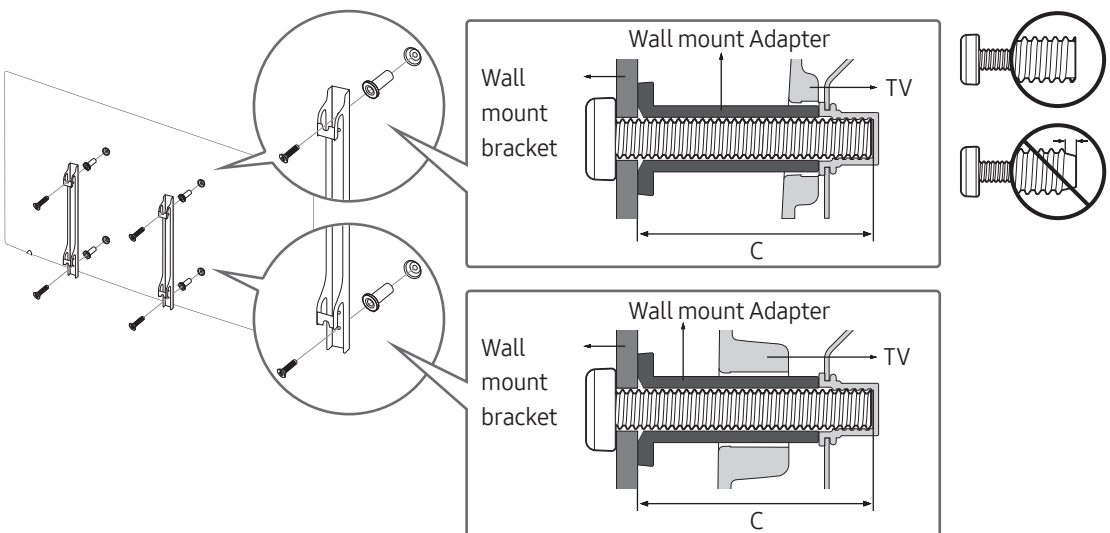

- Samsung Electronics is not responsible for any damage to the product or injury to yourself or others if you choose to install the wall mount on your own.
- You can install your wall mount on a solid wall perpendicular to the floor. Before attaching the wall mount to surfaces other than plaster board, contact your nearest dealer for additional information. If you install the TV on a ceiling or slanted wall, it may fall and result in severe personal injury.
- Standard dimensions for wall mount kits are shown in the table below.
- If you are installing a third-party wall mount, note that the length of the screws you can use to attach the TV to the wall mount is shown in column C in the table below.
- When installing a wall mount kit, we recommend you fasten all four VESA screws.
- If you want to install a wall mount kit that attaches to the wall using two top screws only, be sure to use a Samsung wall mount kit that supports this type of installation. (You may not be able to purchase this type of wall mount kit, depending on the geographical region.)

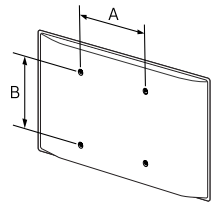
TV size in inches	VESA screw hole specs (A * B) in millimetres	C (mm)	Standard Screw	Quantity	
49 ~ 75	400 x 400	43 ~ 45	M8	4	



Do not install your wall mount kit while your TV is turned on. This may result in personal injury from electric shock.

- Do not use screws that are longer than the standard dimension or do not comply with the VESA standard screw specifications. Screws that are too long may cause damage to the inside of the TV set.
- For wall mounts that do not comply with the VESA standard screw specifications, the length of the screws may differ depending on the wall mount specifications.
- Do not fasten the screws too firmly. This may damage the product or cause the product to fall, leading to personal injury. Samsung is not liable for these kinds of accidents.
- Samsung is not liable for product damage or personal injury when a non-VESA or non-specified wall mount is used or when the consumer fails to follow the product installation instructions.
- Do not mount the TV at more than a 15 degree tilt.
- Always have two people mount the TV onto a wall.

Providing proper ventilation for your TV

When you install your TV, maintain a distance of at least 10 cm between the TV and other objects (walls, cabinet sides, etc.) to ensure proper ventilation. Failing to maintain proper ventilation may result in a fire or a problem with the product caused by an increase in its internal temperature.

When you install your TV with a stand or a wall mount, we strongly recommend you use parts provided by Samsung Electronics only. Using parts provided by another manufacturer may cause difficulties with the product or result in injury caused by the product falling.

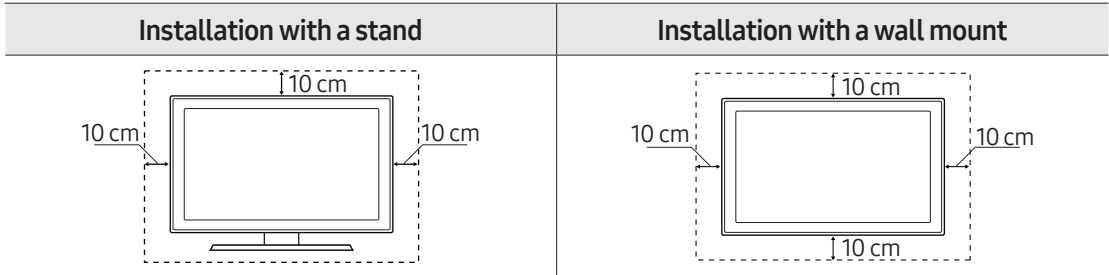

Other Cautions

- The actual appearance of the TV may differ from the images in this manual, depending on the model.
- Be careful when you touch the TV. Some parts can be somewhat hot.

Safety Precaution: Securing the TV to the wall to prevent falling



Caution: Pulling, pushing, or climbing on the TV may cause the TV to fall. In particular, ensure your children do not hang on or destabilise the TV. This action may cause the TV to tip over, causing serious injuries or death. Follow all safety precautions provided in the Safety Flyer included with your TV. For added stability and safety, you can purchase and install the anti-fall device as described below.



WARNING: Never place a television set in an unstable location. The television set may fall, causing serious personal injury or death. Many injuries, particularly to children, can be avoided by taking simple precautions such as

- Using cabinets or stands recommended by the manufacturer of the television set.
- Only using furniture that can safely support the television set.
- Ensuring the television set is not overhanging the edge of the supporting furniture.
- Not placing the television set on tall furniture (for example, cupboards or bookcases) without anchoring both the furniture and the television set to a suitable support.
- Not placing the television set on cloth or other materials that may be located between the television set and supporting furniture.
- Educating children about the dangers of climbing on furniture to reach the television set or its controls.

If you are retaining and relocating the television set that you are replacing with this new set, you should apply the same precautions to the old set.

Preventing the TV from falling

1. Using the appropriate screws, firmly fasten a set of brackets to the wall.
to the wall. Confirm that the screws are firmly attached to the wall.
 - You may need additional material such as wall anchors depending on the type of wall.
2. Using the appropriately sized screws, firmly fasten a set of brackets to the TV.
 - For the screw specifications, refer to "Standard Screw" in the table on the previous page.
3. Connect the brackets fixed to the TV and the brackets fixed to the wall with a durable, heavy-duty string, and then tie the string tightly.
 - Install the TV near the wall so that it does not fall backwards.
 - Connect the string so that the brackets fixed to the wall are at the same height as or lower than the brackets fixed to the TV.

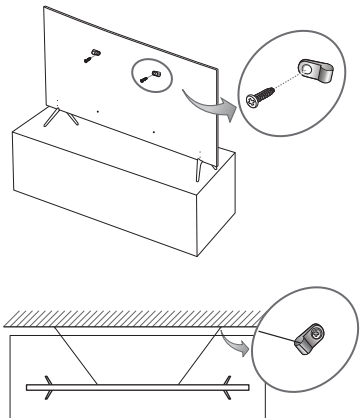

03 The TV Controller

Using the TV Controller

You can turn on the TV with the **TV Controller** button at the bottom of the TV, and then use the **Control menu**. The **Control menu** appears when the **TV Controller** is pressed while the TV is On. For more information about its usage, refer to the figure below.

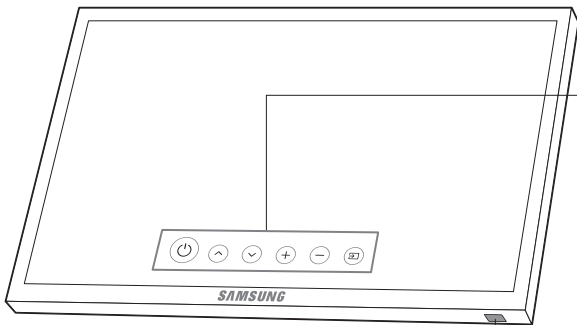

Control menu

- ⏻ : Power off
- ⏪ : Channel Up
- ⏩ : Channel Down
- ⏮ : Volume Up
- ⏭ : Volume Down
- ⏴ : Source

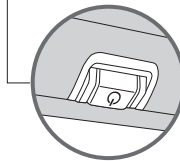

TV Controller / Remote control sensor

Press: Move

Press & Hold: Select

The **TV Controller** is located on the bottom of the TV.

The Standard Remote Control

Learn where the function buttons are on your remote, such as: **SOURCE**, **TTX/MIX**, **PRE-CH**, **CH**, **CH LIST**, **SETTINGS**, **REC**, **INFO**, **RETURN** and **EXIT**.

- This remote control has Braille points on the **Power**, **Channel**, **Volume**, and **Enter** buttons and can be used by visually impaired persons.
- Your TV also comes with a Samsung Smart Remote. For more information about the Samsung Smart Remote, refer to page 16.

Power
Turns the TV on and off.

SOURCE
Displays and selects available video sources.

-VOL+
Adjusts the volume.

MUTE
Turns the sound on/off.

CH
Changes the current channel.

CH LIST
Launches the **Channel List**.

SETTINGS
Sets the **Quick Settings** the menu on the **Settings** of the home screen.

(Smart Hub)
Launches **Home Screen**.

GUIDE
Displays the Electronic Programme Guide (EPG).

PIC SIZE
Changes the picture size.

PICTURE
Changes the picture mode.

AD/SUBT.
Displays the **Accessibility Shortcuts**.

■
Stops playing content.

Number
Gives direct access to channels.

TTX/MIX
Alternately selects Teletext ON, Double, Mix or OFF.

PRE-CH
Returns to the previous channel.

REC
Records whatever you are currently watching.

- This function is not available in specific geographical areas.

INFO
Displays information about the current programme or content.

(Enter)
Selects or runs a focused item.

▲ ▼ ◀ ▶
Moves the cursor, selects the on-screen menu items, and changes the values seen on the TV's menu.

RETURN
Returns to the previous menu or channel.

EXIT
Exits the menu.

A, B, C, D
Use these buttons according to the directions on the TV screen.

◀ ▶ || ▶▶
Use these buttons with specific features. Use these buttons according to the directions on the TV screen.

- The button names above may be differ from the actual names.

The Samsung Smart Remote

- Colours and shape may vary depending on the model.
- For more information about Samsung Smart Remote, see the e-Manual chapter, "**Remote Control and Peripherals > About the Samsung Smart Remote.**"

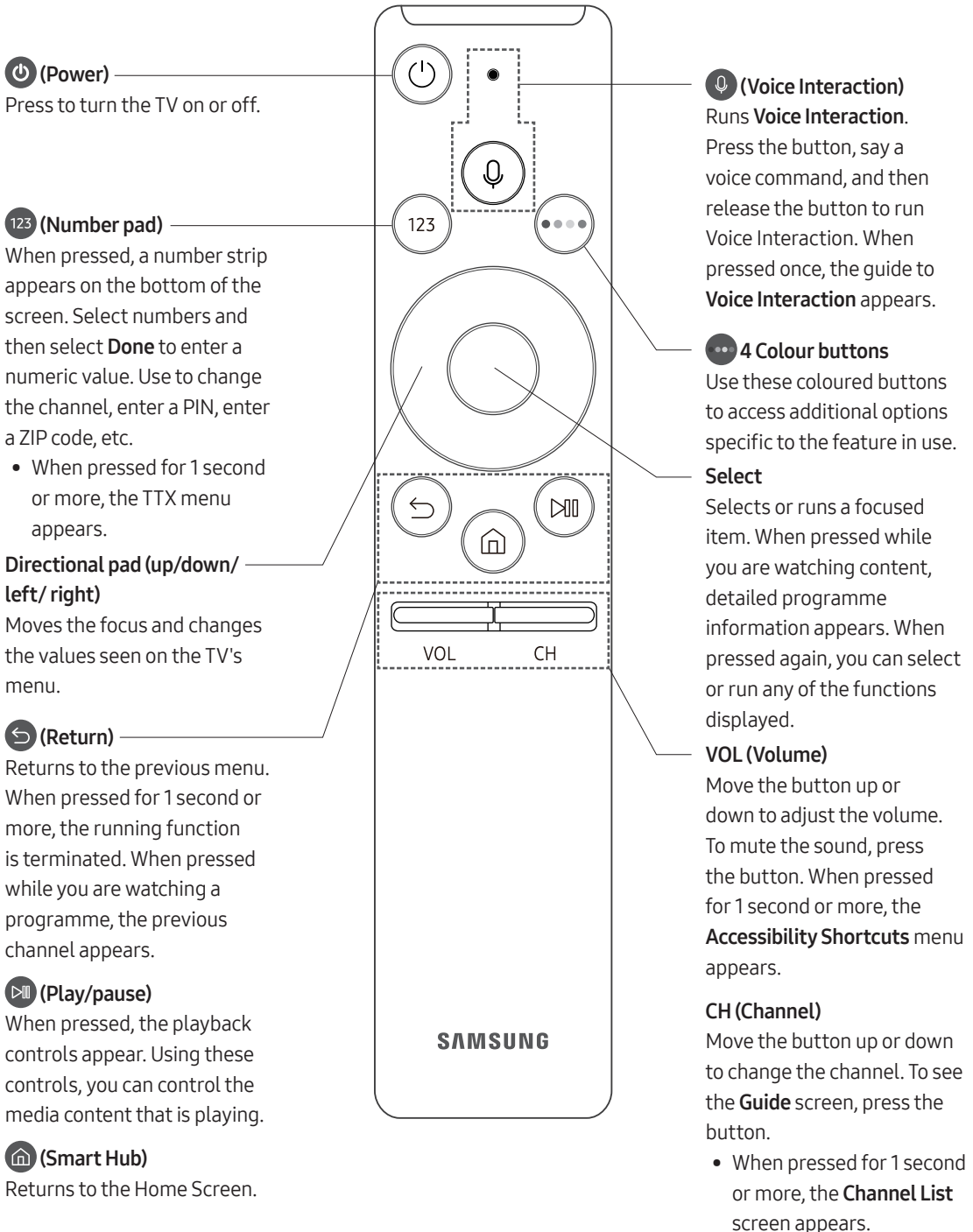

Installing batteries into the remote control (Battery size: AAA)

Match the polarities of the batteries to the symbols on the battery compartment.

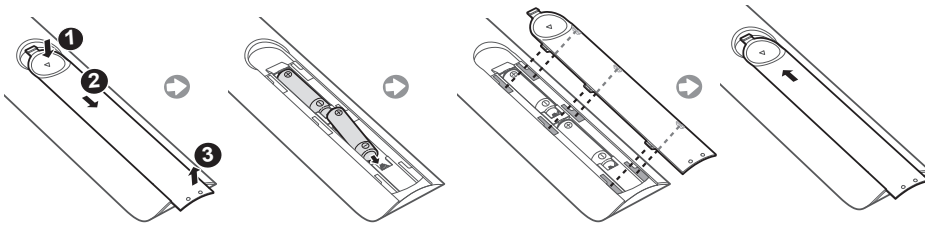

- The colour and shape of the remote may vary depending on the model.
 - Use the remote control within 7 m of the TV.
 - Bright lights may affect the performance of the remote control. Avoid using the remote control near special fluorescent lights or neon signs.
1. Gently pull on the battery cover's notch and then remove the cover completely once it comes loose.
 2. Insert 2 AAA alkaline batteries, making sure to align the positive and negative polarities correctly.
 3. Place the battery cover on the remote control and insert the cover into the remote control.
 4. Slide the battery cover in the order shown so that the cover is completely attached to the remote control.

Installing batteries into the Samsung Smart Remote

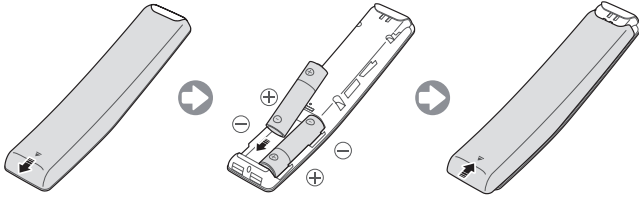

To install the batteries, push the rear cover open in the direction of the arrow, and then insert the batteries as shown in the figure. Make sure that the positive and negative ends are facing in the correct direction.



- Alkaline batteries are recommended for longer battery life.

About the Samsung Smart Remote

When you start the TV for the first time by pressing the **⏻ (Power)** button on the Samsung Smart Remote, the TV automatically pairs with the Samsung Smart Remote. Once the TV and Samsung Smart Remote have paired, you can use the Samsung Smart Remote to operate the TV.

We recommend using Samsung Smart Remote at a distance of less than 6m. A usable distance may differ depending on the wireless environmental conditions.

Pairing the TV to the Samsung Smart Remote

When you turn on the TV for the first time, the Samsung Smart Remote pairs to the TV automatically. If the Samsung Smart Remote does not pair to the TV automatically, point it at the remote control sensor of the TV, and then press and hold the  and  buttons simultaneously for 3 seconds or more.

- The Samsung Smart Remote can only be paired to one TV at a time.

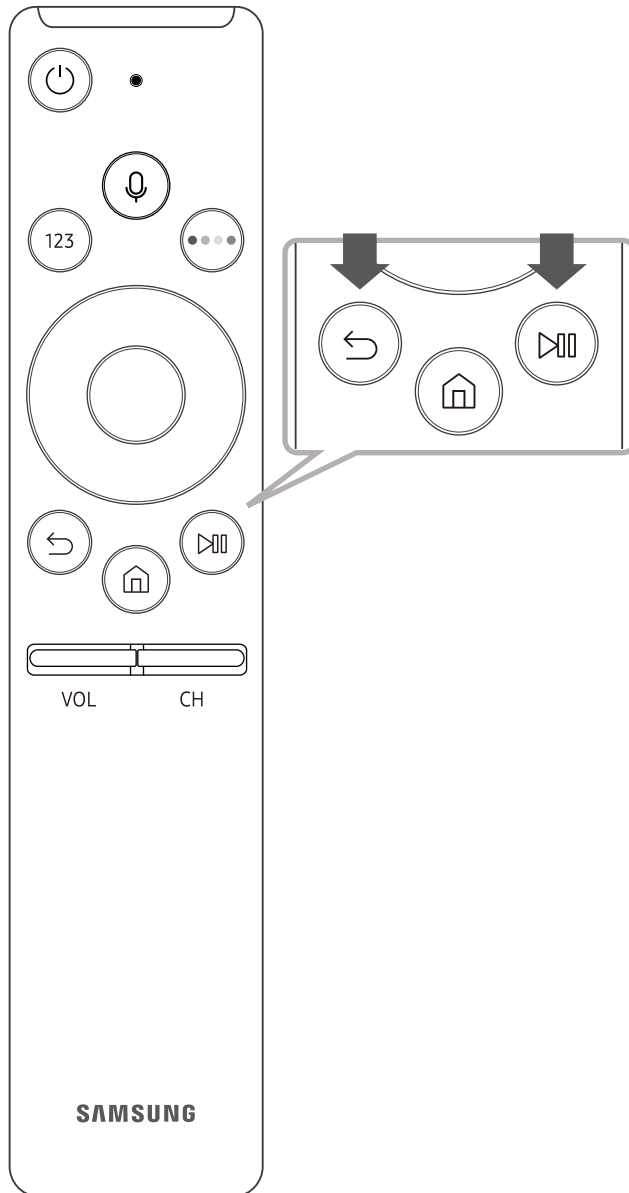

Controlling External Devices with the TV Remote - Using the Universal Remote

 >  Source > Universal Remote



You can control external devices connected to the TV using the remote control. To control external devices, register them by following the instructions on the screen.

- Availability depends on the specific model.
- You can also use the **Anynet+ (HDMI-CEC)** function to operate external Samsung devices with your TV's remote control without any additional setup.
- Certain external devices connected to the TV may not support the universal remote feature.
- Do not place any obstacles in front of an external device. It may cause signals from the remote control to be transmitted improperly.
- The TV memorises both the external device and its connection port (HDMI 1, HDMI 2, etc.).

04 Performing the initial setup

- The initial setup differs from model to model.
- Turn on the TV using the  button on the remote control or TV controller.

Initial setup

The initial setup dialogue box appears when the TV is first activated. Follow the on-screen instructions to finish the initial setup process such as selecting the menu language, scanning channels, connecting to the network, and more. During each step, either make a choice or skip the step. You can manually perform this process at a later time in the  >  **Settings** > **General** > **Start Setup** menu.

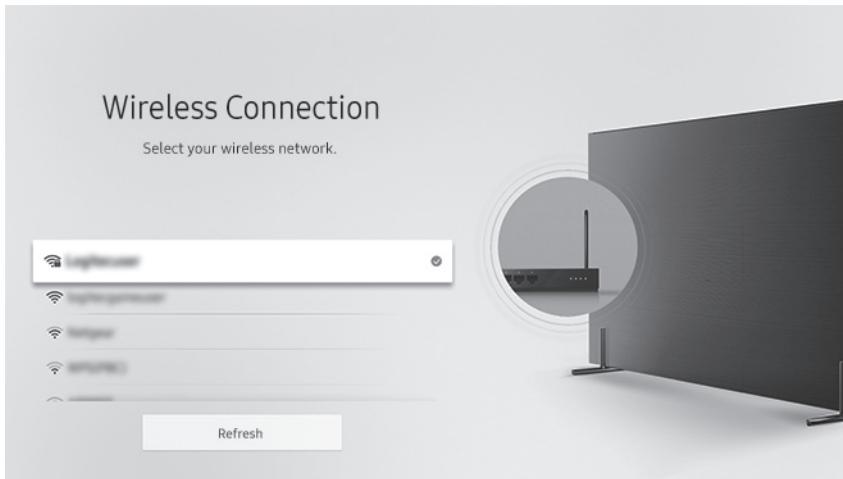

- If you connect any external device to HDMI IN (STB) before starting initial setup, the source of your live TV signal is set to **STB**. After finishing with this process, you will not be able to scan all channels and stores them in the TV's memory.
- If you want to connect aerial cable to your TV, select **Aerial**. In this case, you will be able to scan all channels and stores them in the TV's memory.

05 Connections



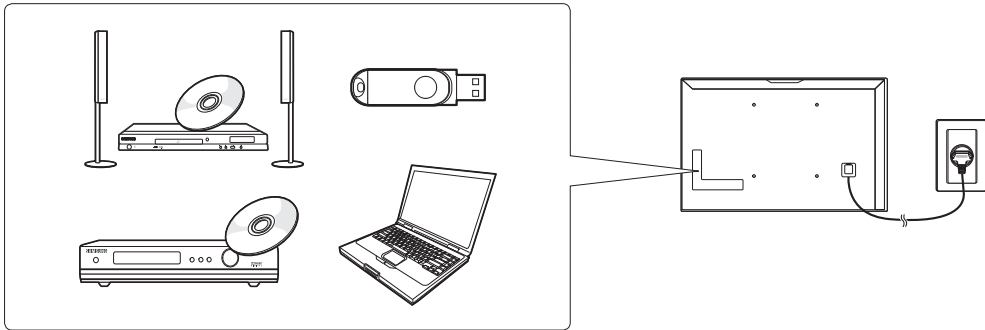

Connecting devices to your TV

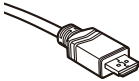

You can connect various external devices using the connectors located at the back of the product. Check the connectors and then refer to the Quick Guide for more instructions on supported external devices.

For more information about connections, see the **e-Manual** chapter "**Connections.**"

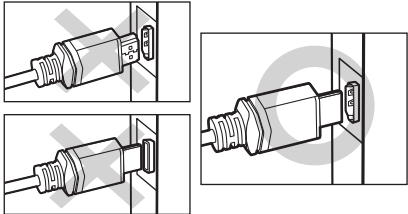
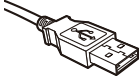
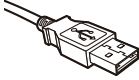
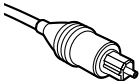
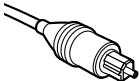
Make sure you have the correct cable before plugging it in. Illustrations of common plugs and ports are shown below.

	Cable Plugs	Ports	
HDMI			 <p> Warning Do not plug cables in upside down. Be sure to check the orientation of the plug before plugging it in.</p>
USB			
Optical			

Connecting to the Internet

Connecting the TV to a network gives you access to online services such as the Smart Hub, as well as software updates.

- For more information about Smart Hub, see the e-Manual chapter, "**Smart Features > Smart Hub.**"
- The shape of the rear panel differs among the models.

Network Connection - Wireless

Connect the TV to the Internet using a standard router or modem.

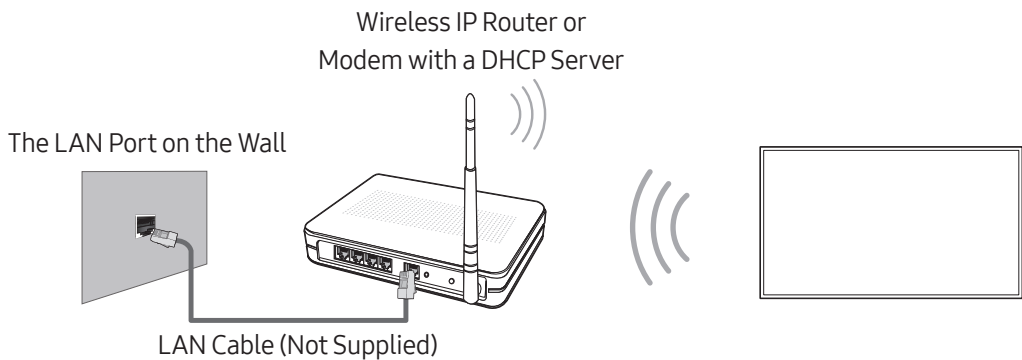

Network Connection - Wired

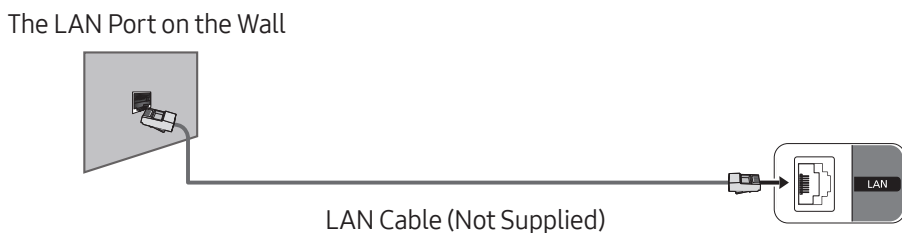

There are three main ways to connect your TV to your network using cable, depending on your network setup. They are illustrated starting below:



- The TV does not support network speeds less than or equal to 10Mbps.
- Use Cat7 (*STP Type) cable for the connection.
 - * Shielded Twist Pair

06 Selecting Connected Devices

Changing the input signal

 >  **Source**

When you select a connected external device on the **Source** screen, the output of the selected device is displayed on the TV's screen.

- For more information about selecting connected devices, see the e-Manual chapter "**Switching between external devices connected to the TV**".

Editing external devices

You can change the port name for a connected external device or add it to Home Screen.

1. Move the focus to a connected external device.
2. Press the Up directional button. The following 2 functions become available. (Note that available functions may differ with the port type.)
 - **Edit:** You can change the port name of an external device for easy identification.
 - **Add to Home:** You can add the port of an external device to the Home Screen for quick switching.
 - **Information:** You can view the detailed information about the external devices connected to the TV.

Using additional functions

You can use the following features on the **Source** screen.

- **Connection Guide:** The guide to device connections
- **Universal Remote:** The function that lets you register external devices to your Samsung Smart Remote and control them using the standard remote control.

07 Troubleshooting and Maintenance

Troubleshooting

If the TV seems to have a problem, first review this list of possible problems and solutions. Alternatively, review the Troubleshooting Section in the e-Manual. If none of these troubleshooting tips apply, please visit “www.samsung.com” and click on Support, or contact the call centre listed on the back cover of this manual.

- This TFT LED panel is made up of sub pixels which require sophisticated technology to produce. There may be, however, a few bright or dark pixels on the screen. These pixels will have no impact on the performance of the product.
- To keep your TV in optimum condition, upgrade to the latest software. Use the **Update Now** or **Auto update** functions on the TV's menu (🏠 > ⚙️ **Settings** > **Support** > **Software Update** > **Update Now** or **Auto update**).

The TV won't turn on.

- Make sure that the AC power cord is securely plugged in to the TV and the wall outlet.
- Make sure that the wall outlet is working and the power indicator on the TV is lit and glowing a solid red.
- Try pressing the Power button on the TV to make sure that the problem is not with the remote control. If the TV turns on, refer to “Remote control does not work” below.

There is no picture/video/sound, or a distorted picture/video/sound from an external device, or “Weak or No Signal” is displayed on the TV, or you cannot find a channel.

- Make sure the connection to the device is correct and that all cables are fully inserted.
- Remove and reconnect all cables connected to the TV and the external devices. Try new cables if possible.
- Confirm that the correct input source has been selected (🏠 > **Source**).
- Perform a TV self diagnosis to determine if the problem is caused by the TV or the device (🏠 > ⚙️ **Settings** > **Support** > **Self Diagnosis** > **Start Picture Test** or **Start Sound Test**).
- If the test results are normal, reboot the connected devices by unplugging each device's power cord and then plugging it in again. If the issue persists, refer to the connection guide in the user manual of the connected device.
- If the TV is not connected to a cable or satellite box, run **Auto Tuning** to search for channels (🏠 > ⚙️ **Settings** > **Broadcasting** > **Auto Tuning Settings** > **Auto Tuning**).
 - This function is only available on certain models in specific geographical areas.

The remote control does not work.

- Check if the power indicator on the TV blinks when you press the remote's Power button. If it does not, replace the remote control's batteries.
- Make sure that the batteries are installed with their poles (+/-) in the correct direction.
- Try pointing the remote directly at the TV from 1.5 ~ 1.8 m away.
- If your TV came with a Samsung Smart Remote (Bluetooth Remote), make sure to pair the remote to the TV.

The cable or satellite box remote control doesn't turn the TV on or off or adjust the volume.

- Programme the cable or satellite box remote control to operate the TV. Refer to the cable or satellite box user manual for the SAMSUNG TV code.

The TV settings are lost after 5 minutes.

- The TV is in the **Retail Mode**. Change the **Usage Mode** in the **General Menu** to **Home Mode** (🏠 > ⚙️ **Settings** > **General** > **System Manager** > **Usage Mode** > **Home Mode**).



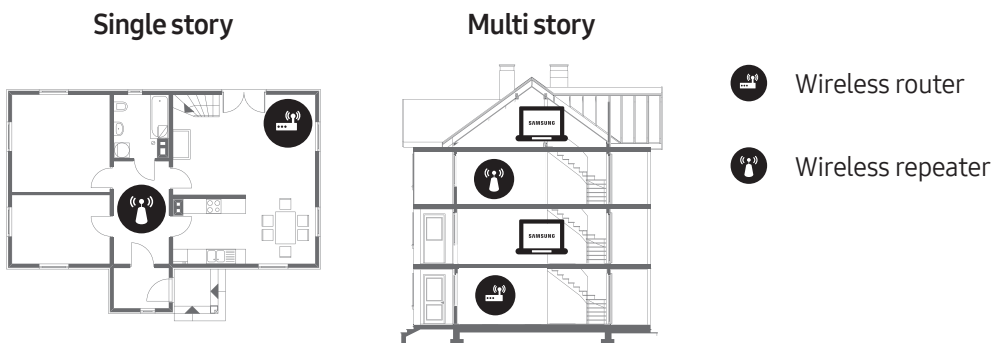

Intermittent Wi-Fi

- Make sure the TV has a network connection (🏠 > ⚙️ **Settings** > **General** > **Network** > **Network Status**).
- Make sure the Wi-Fi password is entered correctly.
- Check the distance between the TV and the Modem/Router. The distance should not exceed 15.2 m.
- Reduce interference by not using or turning off wireless devices. Also, verify that there are no obstacles between the TV and the Modem/Router. (The Wi-Fi strength can be decreased by appliances, cordless phones, stone walls/fireplaces, etc.)



- Contact your ISP and ask them to reset your network circuit to re-register the Mac addresses of your new Modem/Router and the TV.

Video App problems (Youtube etc)

- Change the DNS to 8.8.8.8. Select  >  **Settings** > **General** > **Network** > **Network Status** > **IP Settings** > **DNS setting** > **Enter manually** > **DNS Server** > enter 8.8.8.8 > **OK**.
- Reset by selecting  >  **Settings** > **Support** > **Self Diagnosis** > **Reset Smart Hub**.

What is Remote Support?

Samsung Remote Support service offers you one-on-one support with a Samsung Technician who can remotely:

- Diagnose your TV
- Adjust the TV settings for you
- Perform a factory reset on your TV
- Install recommended firmware updates



How does Remote Support work?

You can easily have a Samsung Tech service your TV remotely:

1. Call the Samsung Contact Centre and ask for remote support.
2. Open the menu on your TV and go to the **Support** section.
3. Select **Remote Management**, then read and agree to the service agreements. When the PIN screen appears, provide the PIN number to the agent.
4. The agent will then access your TV.

Eco Sensor and screen brightness



Eco Sensor adjusts the brightness of the TV automatically. This feature measures the light in your room and optimises the brightness of the TV automatically to reduce power consumption. If you want to turn this off, go to  >  **Settings** > **General** > **Eco Solution** > **Ambient Light Detection**.

- If the screen is too dark while you are watching TV in a dark environment, it may be due to the **Ambient Light Detection** function.
- Do not block the sensor with any object. This can decrease picture brightness.

Caring for the TV

- If a sticker was attached to the TV screen, some debris can remain after you remove the sticker. Please clean the debris off before watching TV.
- The exterior and screen of the TV can get scratched during cleaning. Be sure to wipe the exterior and screen carefully using a soft cloth to prevent scratches.
- Do not spray water or any liquid directly onto the TV. Any liquid that goes into the product may cause a failure, fire, or electric shock.
- To clean the screen, turn off the TV, then gently wipe away smudges and fingerprints on the panel with a micro-fiber cloth. Clean the body or panel of the TV with a micro-fiber cloth dampened with a small amount of water. After that, remove the moisture with a dry cloth. While cleaning, do not apply strong force to the surface of the panel because it can damage the panel. Never use flammable liquids (benzene, thinner, etc.) or a cleaning agent. For stubborn smudges, spray a small amount of screen cleaner on a micro-fiber cloth, and then use the cloth to wipe away the smudges.

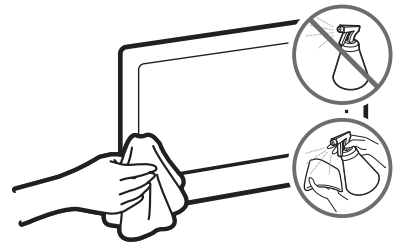

08 Specifications and Other Information

Specifications

Model Name	UE49MU7000	UE55MU7000
Display Resolution	3840 x 2160	3840 x 2160
Screen Size (Diagonal)	49 inches (123 cm)	55 inches (138 cm)
Sound (Output)	40 W	40 W
Stand Swivel (Left / Right)	0°	0°
Dimensions (W x H x D)		
Body	1090.3 x 634.1 x 55.3 mm	1226.1 x 710.5 x 54.8 mm
With stand	1090.3 x 706.2 x 246.1 mm	1226.1 x 782.7 x 246.1 mm
Weight		
Without Stand	14.3 kg	17.4 kg
With Stand	14.7 kg	17.9 kg
Model Name	UE65MU7000	UE75MU7000
Display Resolution	3840 x 2160	3840 x 2160
Screen Size (Diagonal)	65 inches (163 cm)	75 inches (189 cm)
Sound (Output)	40 W	40 W
Stand Swivel (Left / Right)	0°	0°
Dimensions (W x H x D)		
Body	1445.1 x 834.3 x 54.7 mm	1678.4 x 971.3 x 59.6 mm
With stand	1445.1 x 913.3 x 289.6 mm	1678.4 x 1059.4 x 354.2 mm
Weight		
Without Stand	23.4 kg	37.2 kg
With Stand	24.1 kg	38.1 kg

Environmental Considerations

Operating Temperature	10°C to 40°C (50°F to 104°F)
Operating Humidity	10% to 80%, non-condensing
Storage Temperature	-20°C to 45°C (-4°F to 113°F)
Storage Humidity	5% to 95%, non-condensing

- The design and specifications are subject to change without prior notice.
- For information about the power supply, and more information about power consumption, refer to the label-rating attached to the product.
- Typical power consumption is measured according to IEC 62087.
- You can see the label-rating inside of the cover terminal.

Decreasing power consumption

When you shut the TV off, it enters Standby mode. In Standby mode, it continues to draw a small amount of power. To decrease power consumption, unplug the power cord when you don't intend to use the TV for a long time.

Licences



HDMI

The terms HDMI and HDMI High-Definition Multimedia Interface, and the HDMI Logo are trademarks or registered trademarks of HDMI Licensing LLC in the United States and other countries.

Still image warning

Avoid displaying still images (such as jpeg picture files), still image elements (such as TV channel logos, stock or news crawls at the screen bottom etc.), or programmes in panorama or 4:3 image format on the screen. If you constantly display still pictures, it can cause image burn-in on the LED screen and affect image quality. To reduce the risk of this adverse effect, please follow the recommendations below:

- Avoid displaying the same TV channel for long periods.
- Always try to display any image in full screen. Use the picture format menu of the TV for the best possible match.
- Reduce brightness and contrast to avoid the appearance of after-images.
- Use all TV features designed to reduce image retention and screen burn. Refer to the e-Manual for details.

Recommendation - EU Only



Hereby, Samsung Electronics, declares that this TV is in compliance with the essential requirements and other relevant provisions of Directive 1999/5/EC.

The official Declaration of Conformity may be found at <http://www.samsung.com>, go to Support > Search Product Support and enter the model name.

This equipment may only be used indoors.

This equipment may be operated in all EU countries.



**Correct Disposal of This Product (Waste Electrical & Electronic Equipment)
(Applicable in countries with separate collection systems)**

This marking on the product, accessories or literature indicates that the product and its electronic accessories (e.g. charger, headset, USB cable) should not be disposed of with other household waste at the end of their working life. To prevent possible harm to the environment or human health from uncontrolled waste disposal, please separate these items from other types of waste and recycle them responsibly to promote the sustainable reuse of material resources.

Household users should contact either the retailer where they purchased this product, or their local government office, for details of where and how they can take these items for environmentally safe recycling.

Business users should contact their supplier and check the terms and conditions of the purchase contract. This product and its electronic accessories should not be mixed with other commercial wastes for disposal.



**Correct disposal of the batteries in this product
(Applicable in countries with separate collection systems)**

This marking on battery, manual or packaging indicates that the batteries in this product should not be disposed of with other household waste at the end of their working life.

Where marked, the chemical symbols Hg, Cd or Pb indicate that the battery contains mercury, cadmium or lead above the reference levels in EC Directive 2006/66. If batteries are not properly disposed of, these substances can cause harm to human health or the environment.

To protect natural resources and to promote material reuse, please separate batteries from other types of waste and recycle them through your local, free battery return system.

For information on Samsung's environmental commitments and product-specific regulatory obligations, e.g. REACH, WEEE, Batteries, visit http://www.samsung.com/uk/aboutsamsung/samsungelectronics/corporatecitizenship/data_corner.html

WARNING - TO PREVENT THE SPREAD OF FIRE, KEEP CANDLES OR OTHER ITEMS WITH OPEN FLAMES AWAY FROM THIS PRODUCT AT ALL TIMES.



- **WARNINGS:** Image retention, commonly known as screen burn-in, can occur on most types of television if the same image is displayed continuously. The most common causes of image retention are logos that remain stationary on the TV screen. These logos are common on many programmes received via a satellite box. To reduce this risk, avoid displaying still images for long durations and lower the brightness or contrast settings to decrease the intensity of the picture. Extended viewing of movies and programmes in aspect ratios that are different from the aspect ratio of the TV may cause image retention. Always try to avoid black borders at the top or bottom by using the zoom function. This will help eliminate the black borders and fit the picture to the entire area of the screen. Using a video game console may cause image retention and is not recommended. When using a PC input, avoid displaying still images for long durations and reduce the brightness or contrast settings to decrease the intensity of the picture.
- **IMPORTANT:** Image retention issues are not covered by your Samsung® warranty.

Warranty Card



United Kingdom



Republic of Ireland (EIRE)

This Samsung product is warranted for a period of twelve (12) months from the original date of purchase, against defective materials and workmanship. In the event that warranty service is required, you should return the product to the retailer from whom it was purchased. However, Samsung Authorised Dealers and Authorised Service Centres in other EC Countries will comply with the warranty on the terms issued to purchasers in the country concerned. In case of difficulty, details of our Authorised Service Centres are available from:

Samsung Electronics U.K. Ltd
Samsung Customer Support Centre
Selectapost 38, Sheffield, S97 3FJ
United Kingdom

United Kingdom

Tel : 0330 SAMSUNG (7267864)
www.samsung.com/uk/support

EIRE

Tel : 0818 717100
www.samsung.com/ie/support

WARRANTY CONDITIONS

1. The warranty is only valid if, when warranty service is required, the warranty card is fully and properly completed and is presented with the original invoice or sales slip or confirmation, and the serial number on the product has not been defaced.
2. Samsung's obligations are limited to the repair or, at its discretion, replacement of the product or the defective part.
3. Warranty repairs must be carried out by Authorised Samsung Dealers or Authorised Service Centres. No re-imbursment will be made for repairs carried out by non Samsung Dealers and, any such repair work and damage to the products caused by such repair work will not be covered by this warranty.
4. This product is not considered to be defective in materials nor workmanship by reason that it requires adaptation in order to conform to national or local technical or safety standards in force in any country other than the one for which the product was originally designed and manufactured.
5. This warranty covers none of the following:
 - a) Periodic check ups, maintenance and repair or replacement of parts due to normal wear and tear.
 - b) Cost relating to transport, removal or installation of the product.
 - c) Misuse, including the failure to use this product for its normal purposes or incorrect installation.
 - d) Damage caused by Lightning, Water, Fire, Acts of God, War, Public Disturbances, incorrect mains voltage, improper ventilation or any other cause beyond the control of Samsung.
 - e) Spillage of food or liquid or use of any other hazardous substances, which may effect the product.
 - f) Performance due to differences in broadcasting method between countries
6. This warranty is valid for any person who legally acquired possession of the product during the warranty period.
7. The consumers statutory rights in any applicable national legislation whether against the retailer arising from the purchase contract or otherwise are not affected by this warranty. Unless there is national legislation to the contrary, the rights under this warranty are the consumers sole rights and Samsung, its subsidiaries and distributors shall not be liable for indirect or consequential loss or any damage to records, compact discs, videos or audio taper or any other related equipment or material.
8. Some products may differ from these guidelines. Please check with your dealer or the local Samsung web-site.

**This page is intentionally
left blank.**

SAMSUNG



BN68-08442H-00

Contact SAMSUNG WORLD WIDE

If you have any questions or comments relating to Samsung products, please contact the SAMSUNG customer care centre.

Country	Customer Care Centre 	Web Site
EIRE	0818 717100	www.samsung.com/ie/support
UK	0330 SAMSUNG (7267864)	www.samsung.com/uk/support