



RM7501K/RM8601K  
Interactive Flat Panel  
User Manual

## Disclaimer

BenQ Corporation makes no representations or warranties, either expressed or implied, with respect to the contents of this document. BenQ Corporation reserves the right to revise this publication and to make changes from time to time in the contents thereof without obligation to notify any person of such revision or changes.

## Copyright

Copyright 2018 BenQ Corporation. All rights reserved. No part of this publication may be reproduced, transmitted, transcribed, stored in a retrieval system or translated into any language or computer language, in any form or by any means, electronic, mechanical, magnetic, optical, chemical, manual or otherwise, without the prior written permission of BenQ Corporation.

# Table of Contents

Safety warnings and precautions .....	1
Important safety instructions .....	2
Notes on the LCD panel of this display .....	2
Safety notice for remote control .....	3
Battery safety notice .....	3
BenQ ecoFACTS .....	4
Package contents .....	5
Setting up the display .....	6
Mounting the display .....	6
Parts of the display and their functions .....	8
Front/Rear panel .....	8
Input/output terminals .....	9
Remote control .....	10
Using the remote control .....	12
Connection .....	13
Connecting audio/video signals .....	13
Connecting the multimedia inputs .....	16
Connecting the touch module .....	17
Connecting power .....	18
Installing and Removing OPS module .....	19
Using the touch screen .....	20
Important instructions for using the touch screen .....	24
Basic operations .....	25
Turning the display on or off .....	25
Initial Setup .....	25
Sidebar Menu .....	26
Switching input signals .....	27
<b>Eye Care</b> solutions .....	28
Downloading software .....	28
Setting up Internet connection .....	28
Updating software .....	29
Restoring to the default settings .....	30
Adjusting audio volume level .....	30

The OSD (On-Screen Display) menu .....	31
OSD menu overview .....	31
Operations in the OSD menu.....	32
<b>Picture</b> menu.....	33
<b>Sound</b> menu.....	34
<b>Setting</b> menu.....	35
Working with Android OS .....	37
<b>Settings</b> .....	38
<b>Local Application</b> .....	39
<b>BenQ Suggest</b> .....	40
<b>Browser</b> .....	41
<b>ES File Explorer</b> .....	42
<b>InstaQPrint</b> .....	43
<b>InstaQShare</b> .....	44
<b>Multimedia</b> .....	46
<b>WPS Office</b> .....	47
Product information.....	49
Specifications.....	49
Dimensions.....	52
Supported input .....	54
Troubleshooting.....	55

## Safety warnings and precautions



The lightning flash with arrowhead symbol, within an equilateral triangle, is intended to alert the user to the presence of uninsulated "dangerous voltage" within the product's enclosure that may be of sufficient magnitude to constitute a risk of electric shock to persons.



The exclamation point within an equilateral triangle is intended to alert the user to the presence of important operating and maintenance (servicing) instructions in the literature accompanying the appliance.

### THIS EQUIPMENT MUST BE GROUNDED

To ensure safe operation, the three-pin plug must be inserted only into a standard three-pin power outlet which is effectively grounded through normal household wiring. Extension cords used with the equipment must have three cores and be correctly wired to provide connection to the ground. Wrongly wired extension cords are a major cause of fatalities.

The fact that the equipment operates satisfactorily does not imply that the power outlet is grounded or that the installation is completely safe. For your safety, if you are in any doubt about the effective grounding of the power outlet, please consult a qualified electrician.

- The mains plug of the power supply cord shall remain readily operable. The AC receptacle (mains socket outlet) shall be installed near the equipment and shall be easily accessible. To completely disconnect this equipment from the AC mains, disconnect the power cord plug from the AC receptacle.
- Do not place this display on an uneven, sloping or unstable surface (such as a trolley) where it may fall and cause damage to itself or others.
- Do not place this display near water, like a spa or pool, or in a position which will allow the splashing or spraying of water onto the display, like in front of an open window where rain water may enter.
- Do not install this display in a confined space without proper ventilation and air circulation, such as in a closed cabinet. Allow proper space around the display for dissipating heat inside. Do not block any openings and vents on the display. Overheating may result in hazards and electric shock.
- Installation of this display should only be performed by a qualified technician. Failure to install this display properly may cause injuries and damages to the personnels and the display itself. Check the installation regularly and maintain the display periodically to ensure the best working condition.
- Use only the accessories approved or recommended by the manufacturer to mount this display. Using wrong or unsuitable accessories may cause the display to fall and result in serious personal injuries. Make sure that the surface and fixing points are strong enough to sustain the weight of the display.
- To reduce the risk of electric shock, do not remove covers. No user serviceable parts inside. Refer servicing to qualified service personnel.
- To prevent personal injuries, mounting the display or installing desktop stands is required before use.

## Important safety instructions

1. Read these instructions.
2. Keep these instructions.
3. Heed all warnings.
4. Follow all instructions.
5. Do not use this apparatus near water.
6. Clean only with dry cloth.
7. Do not block any ventilation openings. Install in accordance with the manufacturer's instructions.
8. Do not install near any heat sources such as radiators, heat registers, stoves, or other apparatus (including amplifiers) that produce heat.
9. Do not defeat the safety purpose of the polarized or grounding-type plug. A polarized plug has two blades with one wider than the other. A grounding-type plug has two blades and a third grounding prong. The wide blade or the third prong are provided for your safety. If the provided plug does not fit into your outlet, consult an electrician for replacement of the obsolete outlet.
10. Protect the power cord from being walked on or pinched particularly at plugs, convenience receptacles, and the point where they exit from the apparatus.
11. Only use attachments/accessories specified by the manufacturer.
12. Use only with the cart, stand, tripod, bracket, or table specified by the manufacturer, or sold with the apparatus. When a cart is used, use caution when moving the cart/apparatus combination to avoid injury from tip-over.
13. Unplug this apparatus during lightning storms or when unused for long periods of time.
14. Refer all servicing to qualified service personnel. Servicing is required when the apparatus has been damaged in any way, such as power-supply cord or plug is damaged, liquid has been spilled or objects have fallen into the apparatus, the apparatus has been exposed to rain or moisture, does not operate normally, or has been dropped.



## Notes on the LCD panel of this display

- The Liquid Crystal Display (LCD) panel of this display has a very thin protective layer of glass which is liable to marking or scratching, and cracking if struck or pressured. The liquid crystal substrate is also liable to damage under excessive force or extreme temperatures. Please handle with care.
- The response time and brightness of the LCD panel may vary with the ambient temperature.
- Avoid placing the display in direct sun or where direct sun or spot lighting will shine onto the LCD panel, as the heat may damage the panel and the external casing of the display, and the bright light will make viewing the display more difficult than necessary.
- The LCD panel consists of individual pixels to display images and is manufactured according to the design specifications. While 99.9% of these pixels work normally, 0.01% of the pixels may remain constantly lit (in red, blue or green) or unlit. This is a technical limitation of the LCD technology and is not a defect.
- LCD screens, like plasma (PDP) and conventional CRT (Cathode Ray Tube) screens, are also susceptible to 'screen burn-in' or 'image retention' which can be found on the

screen as visible fixed lines and shades. To avoid such damage to the screen, avoid displaying still images (like On-Screen Display menus, TV station logos, fixed/inactive text or icons) for more than 30 minutes. Change the aspect ratio from time to time. Fill the entire screen with the image and eliminate the black bars whenever possible. Avoid displaying images in 16:9 aspect ratio over a long period of time, otherwise there may be visible burn marks on the screen as two vertical lines.

Note: Under certain circumstances, condensation may occur on the inner side of the cover glass, it's a natural phenomenon and will not affect the operation of the display. This condensation will usually disappear after around 2 hours of normal operation.

- RM series does not offer image retention function, for more information, please refer to installation guide.
- RM series does not support portrait use; portrait use may cause display damage. BenQ warranty will not cover faulty usage.

## Safety notice for remote control

- Do not put the remote control in the direct heat, humidity, and avoid fire.
- Do not drop the remote control.
- Do not expose the remote control to water or moisture. Failure to do so could result in malfunction.
- Confirm there is no object between the remote control and the remote sensor of the product.
- When the remote control will not be used for an extended period, remove the batteries.

## Battery safety notice

The use of the wrong type of batteries may cause chemical leaks or explosion. Please note the following:

- Always ensure that the batteries are inserted with the positive and negative terminals in the correct direction as shown in the battery compartment.
- Different types of batteries have different characteristics. Do not mix different types.
- Do not mix old and new batteries. Mixing old and new batteries will shorten battery life or cause chemical leaks from the old batteries.
- When batteries fail to function, replace them immediately.
- Chemicals which leak from batteries may cause skin irritation. If any chemical matter seeps out of the batteries, wipe it up immediately using a dry cloth, and replace the batteries as soon as possible.
- Due to varying storage conditions, the battery life for the batteries included with your product may be shortened. Replace them within 3 months or as soon as you can after initial use.
- There may be local restrictions on the disposal or recycling of batteries. Consult your local regulations or waste disposal provider.

The product is designed for IT power distribution system with phase-to-phase voltage 230V.

## BenQ ecoFACTS

BenQ has been dedicated to the design and development of greener product as part of its aspiration to realize the ideal of the "Bringing Enjoyment 'N Quality to Life" corporate vision with the ultimate goal to achieve a low-carbon society. Besides meeting international regulatory requirement and standards pertaining to environmental management, BenQ has spared no efforts in pushing our initiatives further to incorporate life cycle design in the aspects of material selection, manufacturing, packaging, transportation, using and disposal of the products. BenQ ecoFACTS label lists key eco-friendly design highlights of each product, hoping to ensure that consumers make informed green choices at purchase. Check out BenQ's CSR Website at <http://csr.BenQ.com/> for more details on BenQ's environmental commitments and achievements.





## Package contents

Open the sales package and check the contents. If any item is missing or damaged, please contact your dealer immediately.

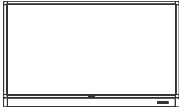

LCD display

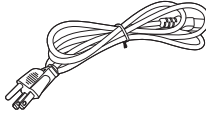

Power cord x6

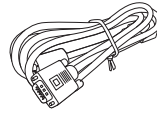

D-Sub (15-pin)  
cable x1



Remote control

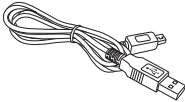

USB cable x1

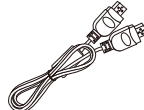

HDMI cable x1

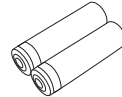

AAA battery x 2

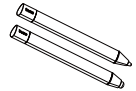

Touch pen x 2



Quick start guide



- The type of power cord supplied may differ from that illustrated depending on your region of purchase.
- Before discarding the package, check that you haven't left any accessories inside the box.
- Dispose of packaging materials wisely. You can recycle the cardboard carton. Consider storing the package (if possible) for future transport of the display.
- Do not leave plastic bags within reach of young children or babies.

# Setting up the display

## Mounting the display

You can install the display on a vertical surface with a suitable wall mounting bracket or on a horizontal surface with the optional desktop stands. Please pay attention to the following notes during installation:

- This display should be installed by at least two adult persons. Attempting to install this display by only one person may result in danger and injuries.
- Refer the installation to qualified technicians. Improper installation may cause the display to fall or malfunction.

## Installing the display on a wall

1. Place a clean, dry and lint-free cloth on a flat, horizontal and object-free surface. Make sure that the size of the cloth is larger than the display.
2. Gently lay the display on the cloth with the LCD screen facing down.
3. Remove the desktop stands from the display if installed.
4. Identify the wall mounting screw holes on the back of the display as shown in the illustration.

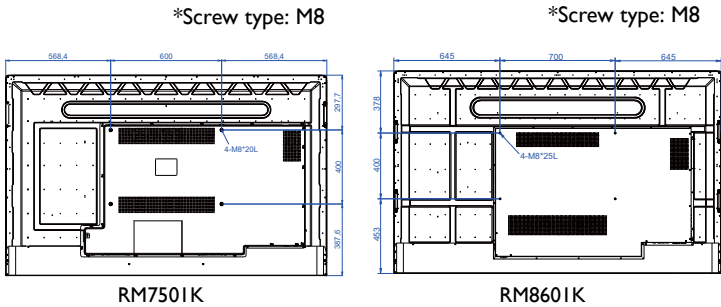

5. Install the wall mounting bracket on the display and attach the display to the wall according to the mounting bracket's instructions. The length of the screw should exceed the thickness of the wall mounting bracket by at least 10 mm. Make sure that all screws are tightened and secured properly. (Recommended torque: 470 - 635N•cm). The mounting means should be strong enough to bear the weight of the display.

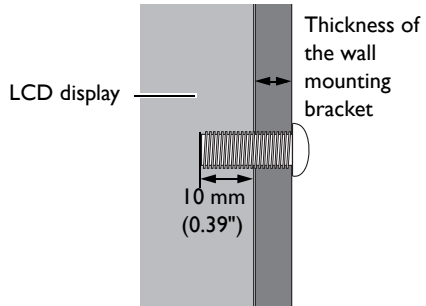



- To maintain proper ventilation, keep at least 10 mm of clear space from the back cover of the display to the wall.
- Please consult a professional technician for wall mount installations. The manufacturer accepts no liability for installations not performed by a professional technician.

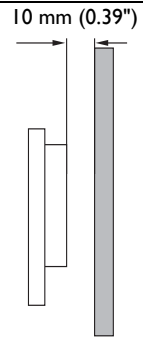

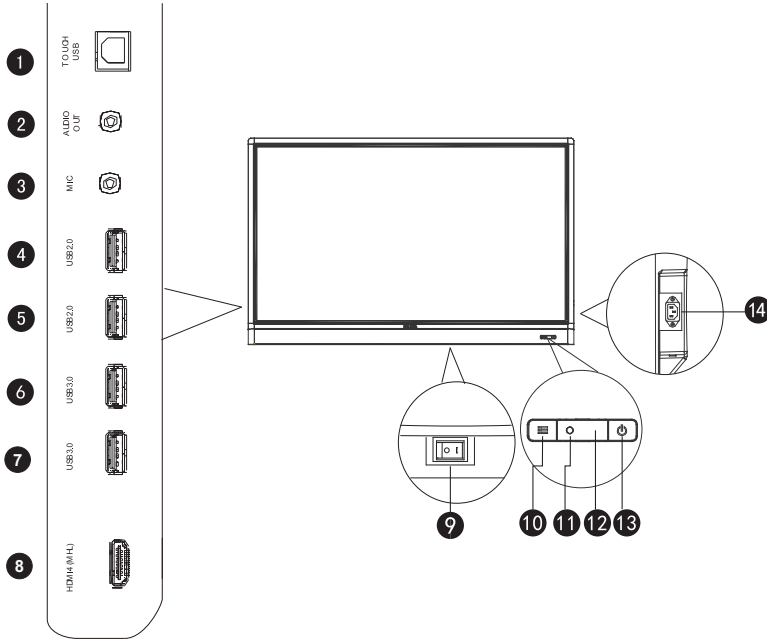

# Parts of the display and their functions

## Front/Rear panel



No.	Name	Description
1	<b>TOUCH USB</b>	Connects the USB cable from the display to a computer to use the touch module.
2	<b>AUDIO OUT</b>	Connects to an external audio device (such as a speaker, stereo system, or headphone) to output the audio that is supplied by the video source.
3	<b>MIC</b>	Connects to a microphone.
4	<b>USB2.0</b>	Accesses multimedia files on USB drives directly.
5	<b>USB2.0</b>	
6	<b>USB3.0</b>	Accesses multimedia files on USB drives directly.
7	<b>USB3.0</b>	
8	<b>HDMI 4(MHL)</b>	Receives HDMI signals from an external device or an MHL compatible device.
9	<b>Power Switch</b>	<p>Used to isolate the power supply from the system.</p> <ul style="list-style-type: none"> <li>• When the switch is set to ON (I), the system will automatically enter standby mode.</li> <li>• When the switch is set to OFF (O), this will completely cut off the power supply.</li> </ul>

10	 <b>MENU</b>	Press to open or close the sidebar menu.
11	<b>Ambient Light Sensor</b>	Detects the ambient room light conditions to automatically adjust the display backlight brightness.
12	<b>Remote Control Sensor</b>	Receives the signal from the remote control.
13	 <b>POWER</b>	Press to turn the display on or off.
14	<b>Power-in</b>	Connects with the supplied power cord.

## Input/output terminals

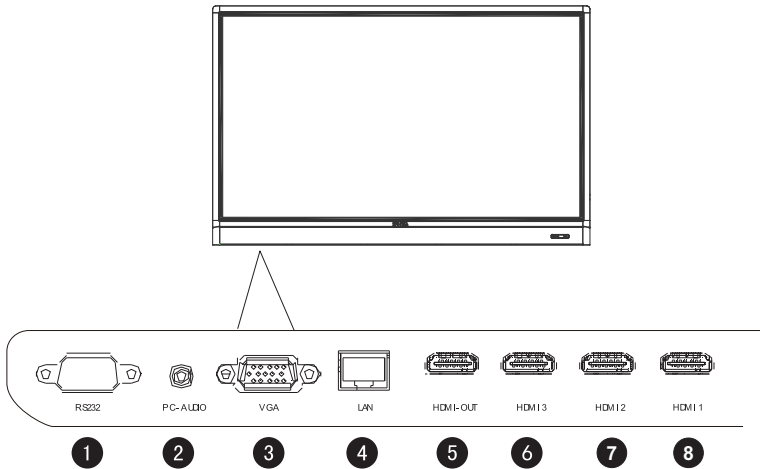

No.	Name	Description
1	<b>RS232</b>	Serial interface, used for mutual transfer of data between devices.
2	<b>PC AUDIO</b>	Receives audio signals from an external device.
3	<b>VGA</b>	Receives analog RGB signals from an external device (such as a computer).
4	<b>LAN</b>	Connects to a network using the Ethernet cable.
5	<b>HDMI OUT</b>	Connects to display devices with an HDMI input ( <b>HDMI 1</b> , <b>HDMI 2</b> , <b>HDMI 3</b> , or <b>OPS</b> input).
6	<b>HDMI 3</b>	Receives HDMI signals from an external device.
7	<b>HDMI 2</b>	Receives HDMI signals from an external device.
8	<b>HDMI 1</b>	Receives HDMI signals from an external device.

## Remote control

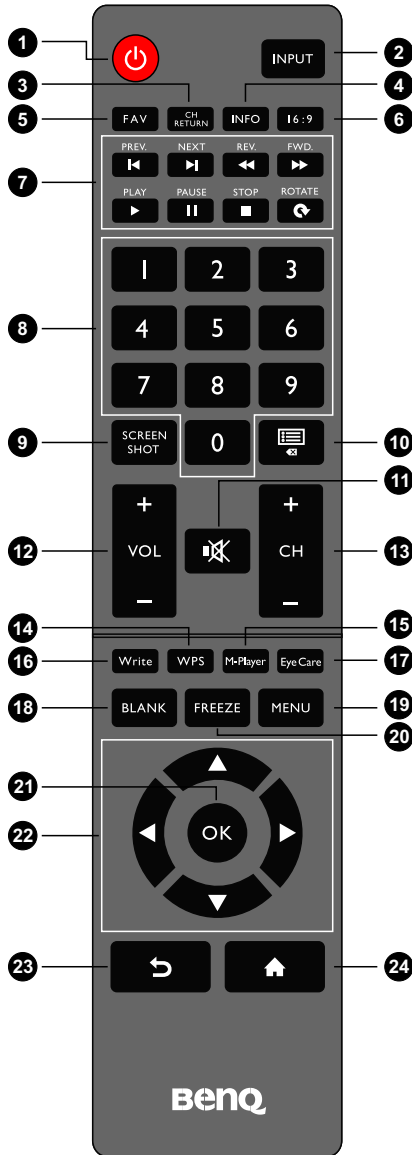

### 1 POWER

Turns the display on or off.

### 2 INPUT

Selects an input source.

### 3 CH RETURN

Returns to the previous program channel (This function is only supported for certain models).

### 4 INFO

Shows the current input source and resolution.

### 5 FAV

Shows the favorite program channel (This function is only supported for certain models).

### 6 16:9

Changes the aspect ratio of the display image.

### 7 MULTI-MEDIA buttons

Used to control the media playback.

### 8 Numeric buttons (0-9)

Performs as numeric buttons when the OSD menu is on.

### 9 SCREEN SHOT

Captures a screenshot and automatically save it to the display's internal memory, or to a USB drive if plugged.

### 10 CHLIST ( )

Deletes a character / displays program list (This function is only supported for certain models).

### 11 MUTE

Turns on or off the mute function.

### 12 VOL- / VOL+

Turns down/up the volume.

### 13 CH- / CH+

- Selects the program channel.

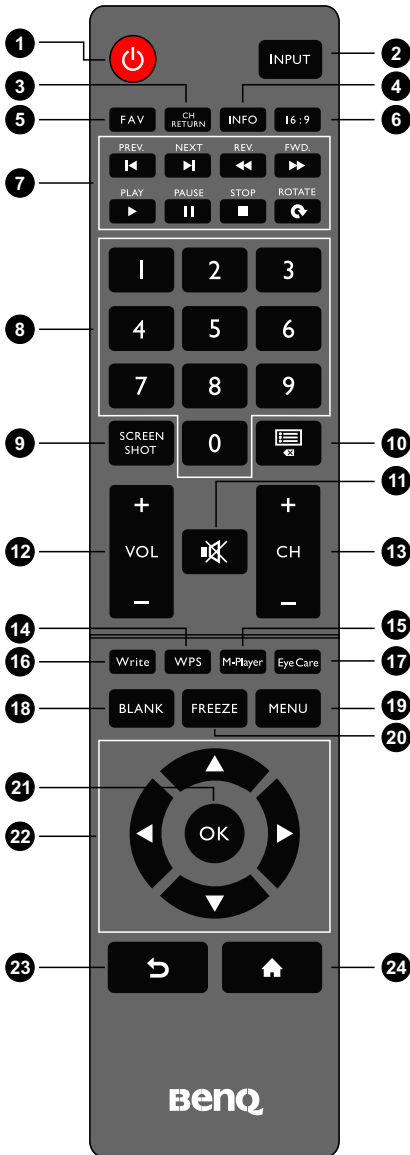

- Press and hold the **CH+** button to enable/disable **Keypad Lock** function.
- Press and hold the **CH-** button to enable/disable **IR Lock** function.

#### 14 WPS

Switches the system into Android OS, then opens the WPS office app.

#### 15 M-Player

Switches the system into Android OS, then opens the Multimedia app.

#### 16 Write

Switches the system into Android OS, then opens the EZWrite 4.1 Lite app.

#### 17 Eye Care

Sets the display mode to **Eyecare** mode. Refer to [Picture menu on page 33](#).

#### 18 BLANK

Hides the image (the screen becomes blank) when the OSD menu is off. Press again to resume normal display.

#### 19 MENU

Opens or closes the OSD menu.

#### 20 FREEZE

Freezes the image when the OSD menu is off.

#### 21 OK

Confirms your selection or save changes.

#### 22 Cursor keys (▲/▼/◀/▶)

Scrolls through settings and options in the OSD menu when the OSD menu is on.

#### 23 Back button (↶)

Returns to the previous page (in Android OS).

#### 24 Home button (⬆)

Returns to the home screen (in Android OS).



The users can keep pushing **Eye Care** on the remote control and then the eye care mode will be shown on the top-left corner of the display, which is the low blue light mode.

## Using the remote control

### Installing remote control batteries



1. Open the remote control battery compartment cover.

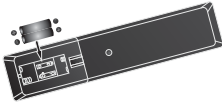

2. Insert the supplied batteries ensuring that the positive and negative marked battery terminals match the (+) and (-) marks in the battery compartment.



The supplied batteries are provided for your convenience so that you can operate the display straight away. You should replace them as soon as possible.



3. Refit the battery compartment cover.

### Remote control usage tips

- Point and aim the top front of the remote control directly at the display's remote control sensor window when you press the buttons.
- Do not let the remote control become wet or place it in humid environments (like bathrooms).
- If the display's remote control sensor window is exposed to direct sunlight or strong light, the remote control may not operate properly. In this situation, change the light source, readjust the angle of the display or operate the remote control from a location closer to display's remote control sensor window.

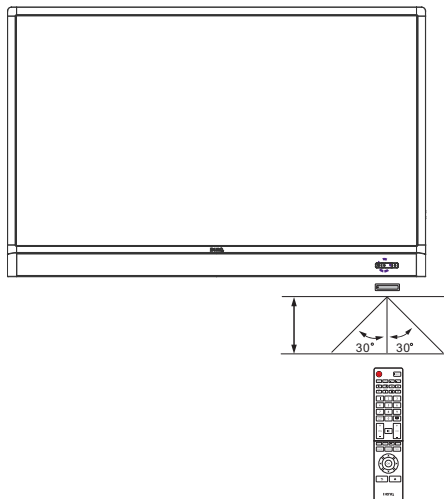



## Connection

### Connecting audio/video signals

Pay attention to the following notes when you connect cables:

- Please turn off all devices.
- Familiarize yourself with the audio/video ports on the display and the devices you want to use. Be aware that incorrect connections may adversely affect picture quality.
- Do not remove cables from the ports by pulling the cable itself. Always grasp and pull the connectors at the end of the cable.
- Ensure that all cables are fully inserted and firmly seated.

### Connecting the VGA input

1. Connect the **VGA** jack on the display to the VGA output jack on a computer using a D-Sub (15-pin) cable.
2. Connect the computer's audio output jack to the **PC AUDIO** jack on the display using a suitable audio cable.
3. To view images from this input, press the **INPUT** button on the remote control, or tap the **Input Source** (⇄) icon in the sidebar menu, and then select **VGA**.

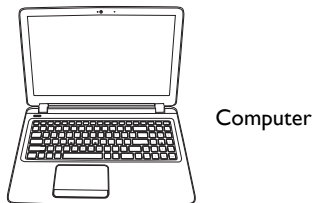
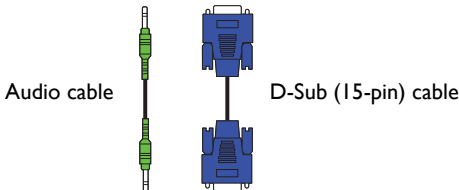
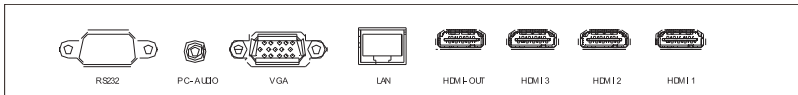

The audio cable is not supplied and should be purchased separately.

## Connecting the digital inputs

1. Connect the HDMI output jack of a computer or A/V device (such as a VCR or DVD player) to the **HDMI 1**, **HDMI 2**, **HDMI 3**, or **HDMI 4(MHL)** input jack on the display using the supplied HDMI cable.
2. To view video image from this input, press the **INPUT** button on the remote control, or tap the **Input Source** (⏮) icon in the sidebar menu, and then select **HDMI 1**, **HDMI 2**, **HDMI 3**, or **HDMI 4**.

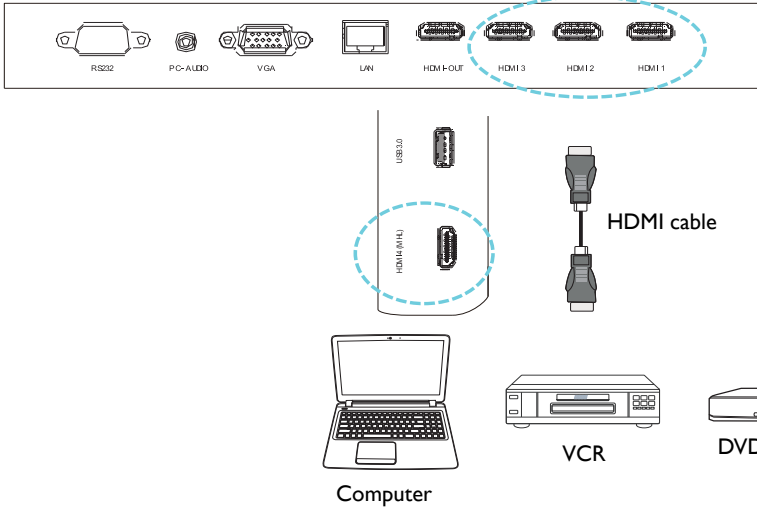

All HDMI ports support 4K resolution.

## Connecting the mobile device inputs

1. Connect the Micro-USB output jack of an MHL compatible device (such as a Smartphone or tablet) to the **HDMI 4(MHL)** input jack on the display using an MHL cable.
2. To view video image from this input, press the **INPUT** button on the remote control, or tap the **Input Source** (↵) icon in the sidebar menu, and then select **HDMI 4**.

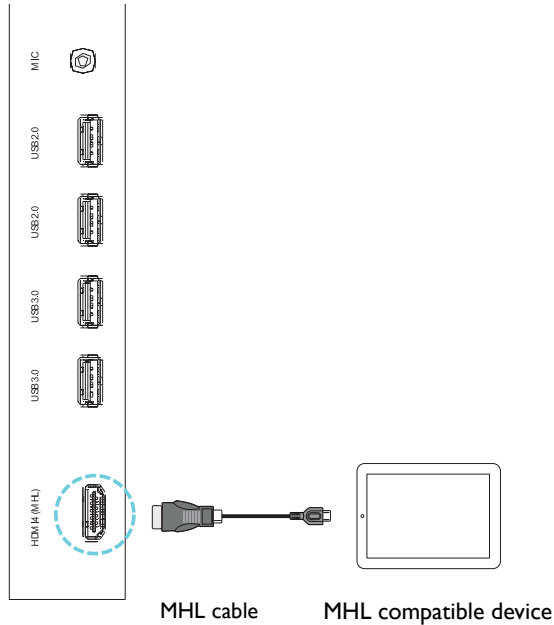

The MHL cable is not supplied and should be purchased separately.

## Connecting the multimedia inputs

To view multimedia files on the USB flash drive:

1. Plug the USB flash drive in the **USB2.0** or **USB3.0** port.
2. A dialog box appears on the screen. Select **Ok** to enter the multimedia mode.



USB flash drive

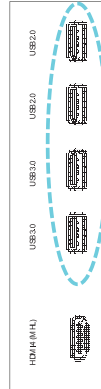

The USB flash drives are not supplied and should be purchased separately.

---

## Connecting the touch module

Connect the USB TYPE A FOR TOUCH (type A) jack (**TOUCH USB**) on the display to the USB port of a computer using the supplied USB cable. The touch module of the display supports easy Plug-and-Play operation. There is no need to install additional drivers on the computer.

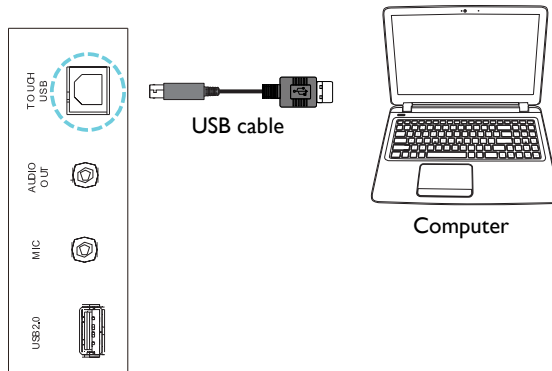

- Avoid blocking the touch screen frame (where sensors are located) when initiating the touch module.
- It is highly recommended that you connect the display to the PC or laptop directly. Avoid connecting the display to a face plate device which may cause failures in touch operations.
- If any ghost image occurs, please try to unplug and then re-plug all USB cables. If the failure image still exists, use another USB type A to A cable.

## Connecting power

Plug one end of the power cord into the Power-in jack on the display and the other end into an appropriate power outlet (if the outlet is switched, turn on the switch).

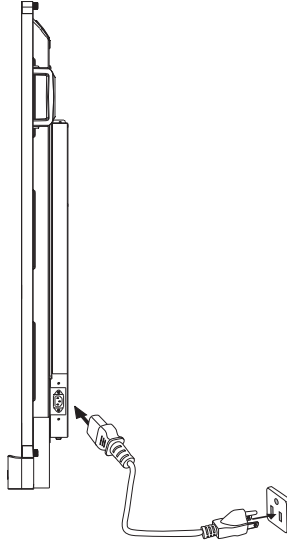

- The supplied power cord is suitable for use with 110-240V AC power only.
- The power cord and outlet illustrated may differ from the ones used in your region.
- Only use an appropriate power cord for your region. Never use a power cord which appears damaged or frayed, or change the plug type on the power cord.
- Be aware of the power loading when you use extension cords or multiple outlet power boards.
- There are no user serviceable parts in this display. Never unscrew or remove any covers. There are dangerous voltages inside the display. Turn off the power and unplug the power cord if you intend to move the display.

## Installing and Removing OPS module

The illustration shown below is for your reference. The actual content, pre-installed applications and available services may vary by the product supplied for your region. OPS module should be purchased separately.

To install the OPS module:

1. Power off the display.
2. Remove the two screws to remove the OPS cover.
3. Insert the OPS module and then secure with screws.



Keep the OPS cover for future use.

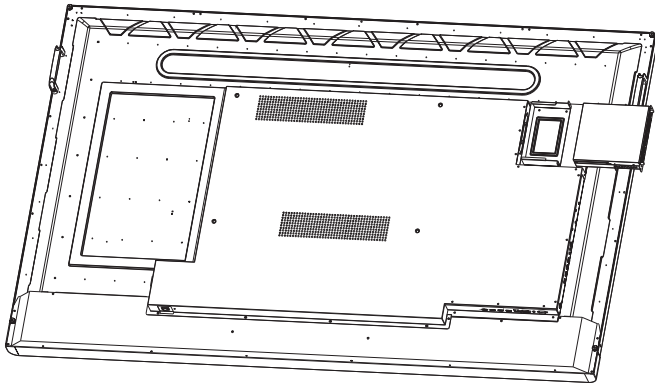

To remove the OPS module:

1. Power off the display.
2. Remove the two screws and pull out the OPS module.

## Using the touch screen



You can use the optical touch screen to control your operating system. The touch screen can emulate basic mouse functions and supports multi-touch functions for Windows 7/8\*. The following table shows a list of gestures you can use on the touch screen.

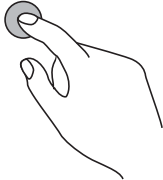
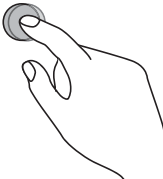
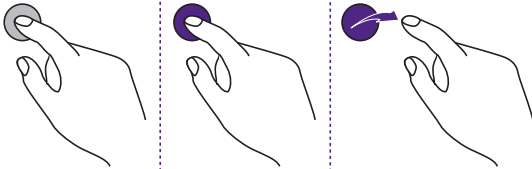
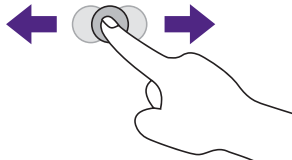

- Ensure that you have installed the USB cable on the display to a computer.
- \*Multi-touch functions are only supported by Windows 8, Windows 7 - Home Premium, Professional, Enterprise and Ultimate versions. For Windows XP, Windows Vista and Windows 7 - Starter and Home Basic versions, multi-touch are not supported.
- Windows is a registered trademark of Microsoft Corporation in the United States and other countries.

OS functions	Gesture actions
For Windows XP, Windows Vista, Windows 7, Windows 8.1, and Windows 10	
Click	Tap the screen once. 
Double-click	Tap the screen twice. 
Right-click	<ol style="list-style-type: none"> <li>1. Press on the target.</li> <li>2. Hold and wait for a blue ring to appear.</li> <li>3. Release your finger.</li> </ol> 
Drag	Drag one finger left or right. 

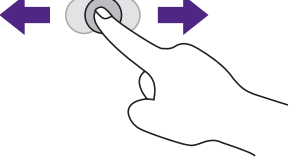
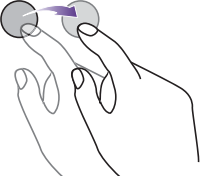

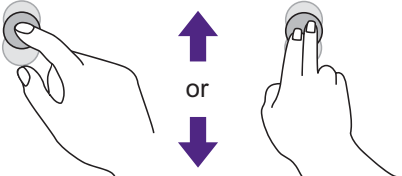
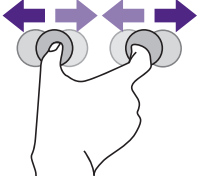
OS functions	Gesture actions
For Windows Vista, Windows 7, Windows 8.1, and Windows 10	
Selection	<p>Drag one finger left or right.</p> 
Pan up / Pan down / Back / Forward	<p>Quickly drag your finger (Flick) in a desired direction.</p> 
Multi-touch functions	
For Windows 7 - Home Premium, Professional, Enterprise and Ultimate versions	
Right-click	<ol style="list-style-type: none"> <li>1. Press on the target.</li> <li>2. Tap the screen with another finger.</li> <li>3. Release the second finger.</li> </ol> 
Scrolling	<p>Drag one or two fingers up or down.</p> 
Zoom	<p>Move two fingers apart or toward each other.</p> 

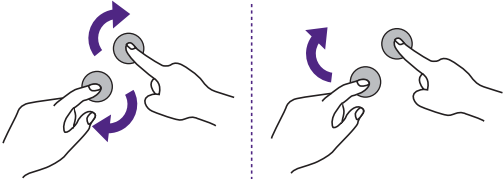
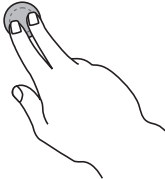
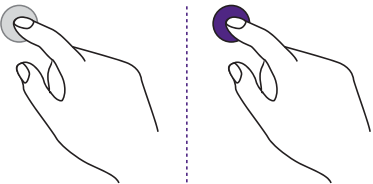
OS functions	Gesture actions
Supported by specific applications	<ul style="list-style-type: none"> <li>• Move two fingers in opposing directions.</li> <li>• Use one finger to pivot around another.</li> </ul> 
Supported by specific applications	<p>Tap two fingers simultaneously. The target should be the midpoint between the fingers.</p> 
For Windows XP, Windows Vista and Windows 7	
Wakeup from Windows sleep mode (S3)	<p>Press and hold for 4 seconds.</p> 

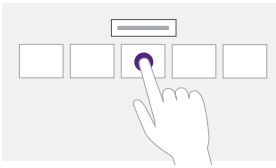
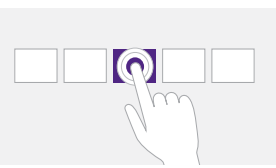
Gesture	Description
For Windows 8	
	<p>Press and hold to learn</p> <p>This touch interaction causes detailed information or teaching visuals (for example, a tooltip or context menu) to be displayed without a commitment to an action. Anything displayed this way should not prevent users from panning if they begin sliding their finger.</p>
	<p>Tap for primary action</p> <p>Tapping on an element invokes its primary action, for instance launching an application or executing a command.</p>

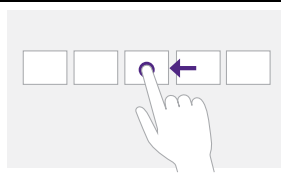
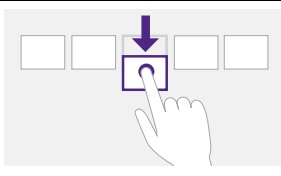
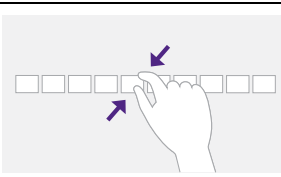
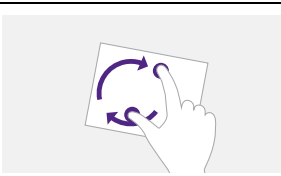
Gesture	Description
	<p><b>Slide to pan</b></p> <p>Slide is primarily used for panning interactions but can also be used for moving, drawing or writing. Slide can also be used to target small, densely packed elements by scrubbing (sliding the finger over related objects such as radio buttons).</p>
	<p><b>Swipe to select, command, and move</b></p> <p>Sliding the finger a short distance, perpendicular to the panning direction, selects objects in a list or grid (ListView and GridLayout controls). Display the AppBar with relevant commands when objects are selected.</p>
	<p><b>Pinch and stretch to zoom</b></p> <p>While the pinch and stretch gestures are commonly used for resizing, they also enable jumping to the beginning, end, or anywhere within content with Semantic Zoom. A Semantic Zoom control provides a zoomed out view for showing groups of items and quick ways to dive back into them.</p>
	<p><b>Turn to rotate</b></p> <p>Rotating with two or more fingers causes an object to rotate.</p>

## Important instructions for using the touch screen

Please clean the frame when there is sign of malfunction on the touch screen.

- Before you clean the screen, make sure the display is turned off, and unplug the power cord.
- Remove dust or dirt from the screen and the infrared plastic filter periodically. It is suggested using a small amount of alcohol to clean the infrared plastic filter.
- To avoid damage to the screen, never use any type of abrasive materials to wipe the screen.
- Use a neutral detergent to clean the touch screen. Avoid using detergents with erosive substance, such as banana oil or ammonia.
- Moisten a clean soft, lint-free cloth with a neutral detergent and then clean the touch screen.
- Do not spray a detergent on the screen surface or the body directly. It may result in a short circuit to the touch screen.
- Keep the touch screen out of direct sunlight or spotlights.

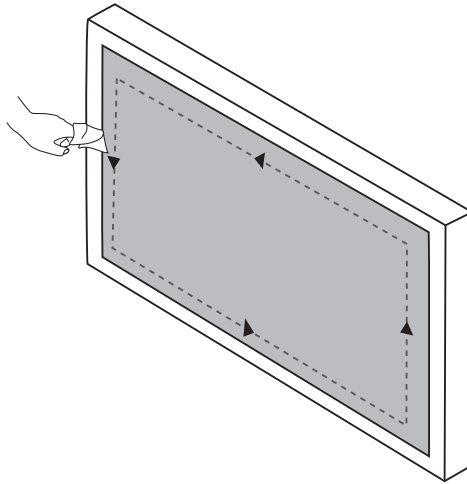

## Basic operations

### Turning the display on or off

Before turning on the display, make sure the power switch is set to ON (I). The system will enter standby mode.

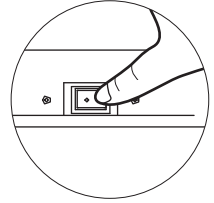

- To turn on the display, press the **POWER** button on the control panel or on the remote control.
- To turn off the display, press the **POWER** button on the control panel or on the remote control. The system will automatically enter standby mode.

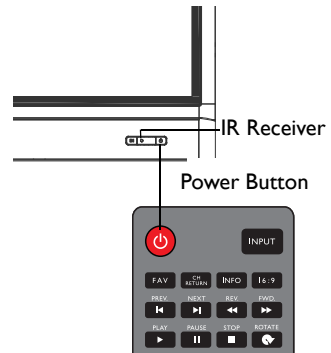

The display's standby mode still consumes power. To completely cut off power supply, set the power switch to OFF (O) and then disconnect the power cord from the power outlet.

## Initial Setup

After you have connected the display to the power, you are ready to power on the display. The first time you power on the display, you will be guided through a series of setup screens. Follow the on-screen instructions or the steps below to start up your display and complete the initial setup.

1. Turn on the display. Wait for the display to boot up with the BenQ screen. This may take a moment.
2. Tap **Next** on the screen to begin. Follow the on-screen instructions to set up the language, date and time, and network. Or you can skip some of these steps and complete the setup later.

## Sidebar Menu

To access the sidebar menu:

1. Press the **MENU** (☰) button on the control panel, or swipe in from the right edge of the screen. The sidebar menu appears at the right side of the screen.

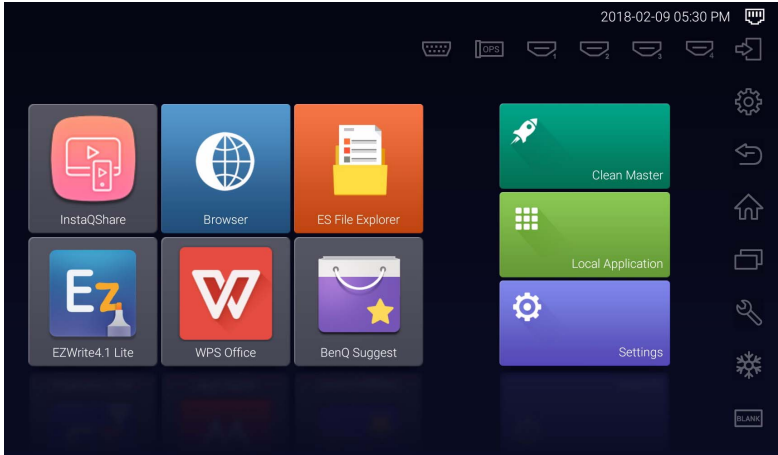

2. Tap the option/function that you want to use.

Options Name/Icon	Description
<b>Input Source</b> (☞)	Selects an input signal. Refer to <a href="#">Switching input signals on page 27</a> for more information.
<b>Display Settings</b> (⚙️)	Opens or closes the OSD menu.
<b>Back</b> (⏪)	Returns to the previous screen or exit the running application.
<b>Home</b> (🏠)	Returns to the Android home screen.
<b>Recent apps</b> (📁)	Displays a list of the most recently used apps.
<b>Tools</b> (🔧)	Reveals additional tools, including <b>Volume</b> , <b>Screen Capture</b> , and <b>Whiteboard</b> functions.
<b>Freeze</b> (❄️)	Freezes the screen, tap again to unfreeze screen.
<b>Blank</b> (BLANK)	Hides the image (the screen becomes blank), tap again to resume normal display.

## Switching input signals

To select an input signal:

- Press the **INPUT** button on the remote control, and press the ◀ or ▶ button to select an input signal.



- Tap the **Input Source** (↔) icon in the sidebar menu, and then tap an input signal.

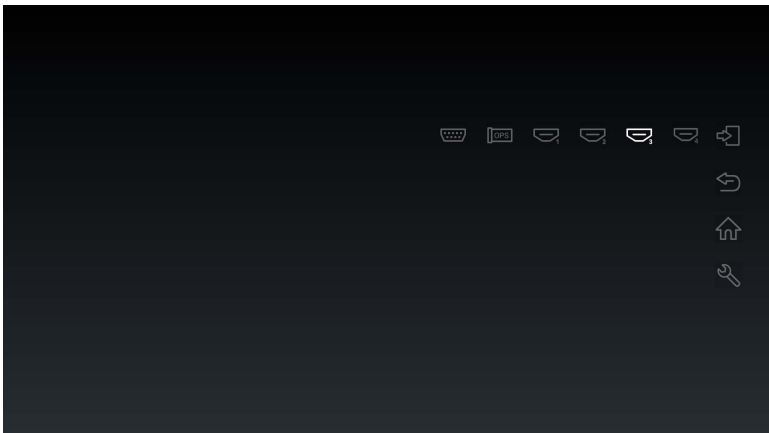

## Eye Care solutions

Blue light with wavelengths under 455 nm could affect vision and age the eyes. **Eye Care** solution is designed for eyesight protection: the display provides proprietary eye-care technology with zero-flicker performance and ultra-low blue light emission, preventing eyestrain, eye fatigue and macular degeneration caused by extended sessions in front of a display. In addition, advanced anti-glare screen treatment minimizes distracting reflections and glare for optimal productivity and comfort.



Suggestions for long-term use of the display:

- Rest your eyes for 10 minutes after 30 minutes of continuous use.
- For every 20 minutes of display viewing, look into the distance for 20 seconds.
- When your eyes get sore and strained, close your eyes for a minute and then roll your eyes in all directions.

## Downloading software

BenQ may periodically release software updates that may add functions or applications associated with your display. To check if there is a software update available for your device or to obtain the software license key, please visit <http://business-display.benq.com/en/findproduct/ifp/software.html>. Then enter the serial number (can be found on the sticker attached on the back of the display) and click **OK** to access the Software download page.

## Setting up Internet connection

Your display must be connected to a network to download updates or surf the Internet.

### Wired Connection

1. Connect one end of the Ethernet cable to the LAN port of the display.
2. Connect the other end of the Ethernet cable to the LAN port of the router.
3. Press the **HOME** (🏠) button on the remote control, or tap the **Home** (🏠) icon in the sidebar menu to open the Android home screen.
4. On the home screen, select **Settings** (⚙️) > **Wireless & networks** (📶) > **Ethernet configuration** to view the internet settings.

### Wireless Connection

Please contact your local dealer for more information on configuring the wireless connection.

1. Press the **HOME** (🏠) button on the remote control, or tap the **Home** (🏠) icon in the sidebar menu to open the Android home screen.
2. On the home screen, select **Settings** (⚙️) > **Wireless & networks** (📶) > **Wi-Fi** > **On/Off** to turn Wi-Fi on.



3. A list of available networks is displayed. Tap the network you want to connect to and tap **Connect**.



If you are connecting to a secured wireless network, enter the password for the wireless network access when prompted and tap **Connect**.

## Updating software

Whenever a new version of software is available, the system will automatically detect the update and will prompt you to download it every time you turn on the display.

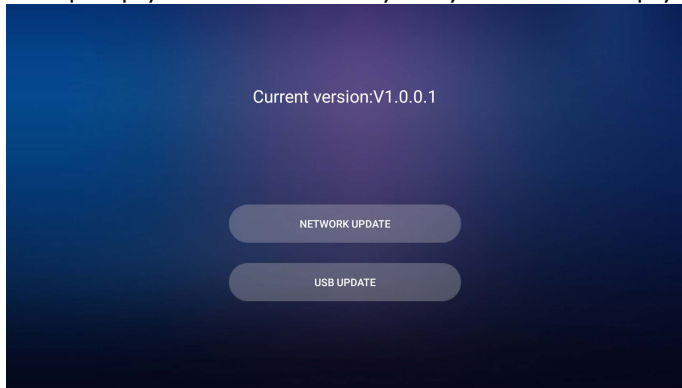

There are two methods that can be used to update the software:

- If you want to update the software via the internet, select **NETWORK UPDATE** and then press the **OK** button on the remote control.
- If you want to update the software via the USB port, select **USB UPDATE** then press the **OK** button on the remote control.

Or you can skip this step and update the software later.



- Software update process may take some time to complete.
- During the update process, do not turn off the device or disconnect the Internet connection. Any interruptions during the software update process may permanently damage your display.

## Restoring to the default settings

If you encounter problems with your display, you can restore all parameters to the factory default settings.



Before performing a factory reset, make sure to back up your important data and files.

There are two methods that can be used to reset your display.

### Via OSD menu

1. Press the **MENU** button on the remote control, or tap the **Display Settings** (⚙️) icon in the sidebar menu to open the OSD menu.
2. Press the ◀ or ▶ button on the remote control (or swipe left or right along the top of the OSD menu on the screen) to select the **Setting** menu.
3. In the **Setting** menu, press the ▲ or ▼ button on the remote control (or scroll down on the screen) to select **Restore To Default**.
4. A confirmation appears on the screen, select **Yes** to reset your display.

### Via Android OS

1. Press the **HOME** (🏠) button on the remote control, or tap the **Home** (🏠) icon in the sidebar menu to open the Android home screen.
2. On the home screen, select **Settings** (⚙️) > **Personal** > **Reset**.
3. In the **Reset** menu, select **Factory data reset**.
4. In the **Factory data reset** menu, select **Reset device** > **Erase everything**.

## Adjusting audio volume level

Press **VOL-** / **VOL+** on the remote control, or tap **Tools** (🔧) > **Volume** (🔊) in the sidebar Menu to adjust the volume.

# The OSD (On-Screen Display) menu

## OSD menu overview

Menu name	Options/functions	See page
Picture	<ul style="list-style-type: none"> <li>• <b>Picture Mode</b></li> <li>• <b>Contrast</b></li> <li>• <b>Brightness</b></li> <li>• <b>Hue</b></li> <li>• <b>Sharpness</b></li> <li>• <b>Saturation</b></li> <li>• <b>Back Light</b></li> <li>• <b>PC Image Mode</b></li> <li>• <b>Color Temperature</b></li> <li>• <b>Zoom Mode</b></li> </ul>	<a href="#">33</a>
Sound	<ul style="list-style-type: none"> <li>• <b>Sound Mode</b></li> <li>• <b>Low Pitch</b></li> <li>• <b>High Pitch</b></li> <li>• <b>Balance</b></li> </ul>	<a href="#">34</a>
Setting	<ul style="list-style-type: none"> <li>• <b>Menu Time</b></li> <li>• <b>Anti Image Retention</b></li> <li>• <b>HDMI_CEC</b></li> <li>• <b>HDMI EDID Version</b></li> <li>• <b>Light Sensor</b></li> <li>• <b>Keypad Lock</b></li> <li>• <b>IR Lock</b></li> <li>• <b>Power On Mode</b></li> <li>• <b>Power Save</b></li> <li>• <b>Boot Source</b></li> <li>• <b>Software Update(USB)</b></li> <li>• <b>Restore To Default</b></li> </ul>	<a href="#">35</a>



Some options are only available when a certain input signal source is selected.

## Operations in the OSD menu

### Using the touch screen

1. Swipe in from the right edge of the screen to reveal the sidebar menu, and tap **Display Settings** (⚙️) to open the OSD menu.



2. Swipe left or right along the top of the OSD menu on the screen to select the submenu.

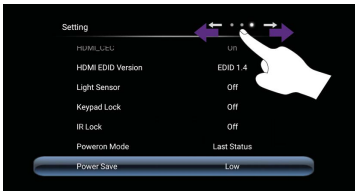

3. Scroll up or down to browse the items.



4. Tap an option to adjust and save the settings.

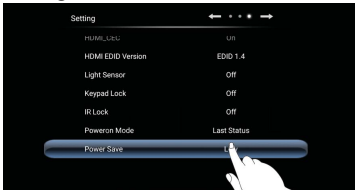

### Using the remote control

1. Press the **MENU** button to open the OSD menu.



2. Press the **▲** or **▼** button to select an item.

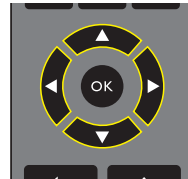

3. Press the **OK** button to confirm selections.

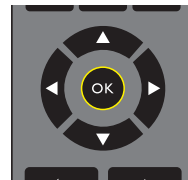



4. Press the **▲** and **▼** button to select a feature and press the **◀** or **▶** button to adjust settings. Press the **OK** button to confirm changes.

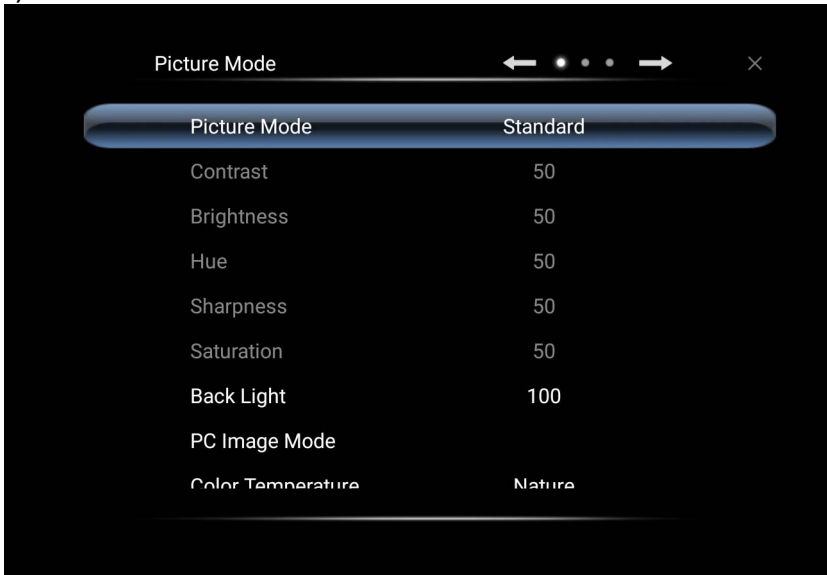

## Picture menu

Screen images and icons in this document are for your reference only. Actual displays may vary.



Name	Description
<b>Picture Mode</b>	Sets the display mode. Available modes are <b>PC</b> , <b>Lightness</b> , <b>Standard</b> , <b>Eyecare</b> , and <b>User</b> . The properties such as <b>Contrast</b> , <b>Brightness</b> , <b>Hue</b> , <b>Sharpness</b> , <b>Saturation</b> , and <b>PC Image Mode</b> can be adjusted if the mode is set to <b>User</b> .  If the mode is set to <b>Eyecare</b> , low blue light will be activated.
<b>Contrast</b>	Adjusts the degree of difference between darkness and lightness.
<b>Brightness</b>	Adjusts the balance between light and dark shades.
<b>Hue</b>	Adjusts the degree of how we perceive colors.
<b>Sharpness</b>	Adjusts the clarity and visibility of the edges of the subjects in the image.
<b>Saturation</b>	Adjusts the purity degree of colors.
<b>Back Light</b>	Adjusts the back light darkness and lightness.
<b>PC Image Mode</b>	Adjusts the PC display settings. Sets PC image mode to <b>Auto Tune</b> to synchronize the display automatically, or manually fine-tunes <b>Clock</b> , <b>Phase</b> , <b>Horizontal Position</b> , and <b>Vertical Position</b> .
<b>Color Temperature</b>	Adjusts the color temperature. Available options are <b>Cold</b> , <b>Nature</b> , and <b>Warm</b> .

<b>Zoom Mode</b>	<p>Sets the aspect ratio of the displayed image.</p> <p>The supported aspect ratio varies depending on the input source:</p> <ul style="list-style-type: none"> <li>• HDMI: <b>Auto, Panorama Mode, Just Scan, 14:9, PC Mode, Default, 16:9, and 4:3.</b></li> <li>• VGA: <b>16:9, 4:3, 14:9, PC Mode, and Default.</b></li> </ul>
------------------	--

## Sound menu

Screen images and icons in this document are for your reference only. Actual displays may vary.

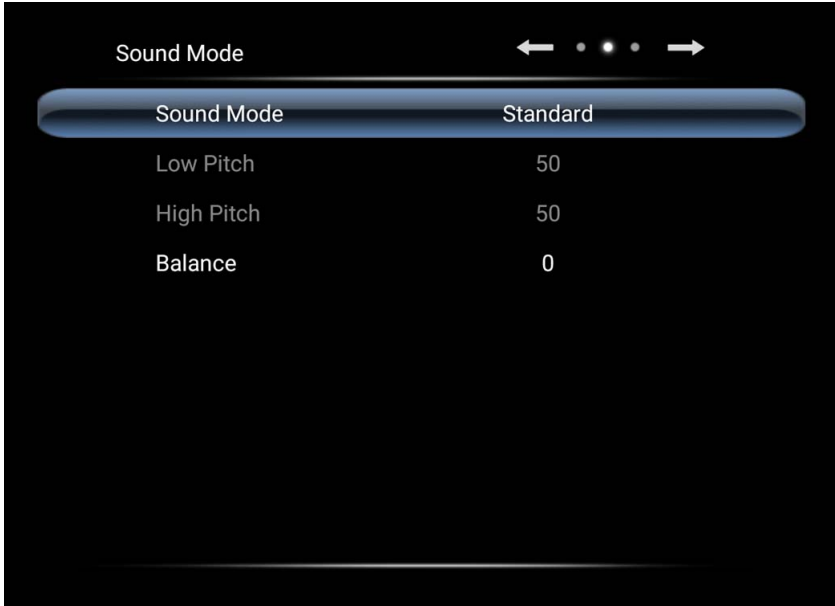

Name	Description
<b>Sound Mode</b>	Selects a preset audio mode. Available modes are <b>Standard, Music, Movie, Sports, and User</b> . The properties such as <b>Low Pitch</b> and <b>High Pitch</b> can be adjusted if the mode is set to <b>User</b> .
<b>Low Pitch</b>	Adjusts the bass level.
<b>High Pitch</b>	Adjusts the treble level.
<b>Balance</b>	Adjusts the sound balance between the left and right speakers.

## Setting menu

Screen images and icons in this document are for your reference only. Actual displays may vary.

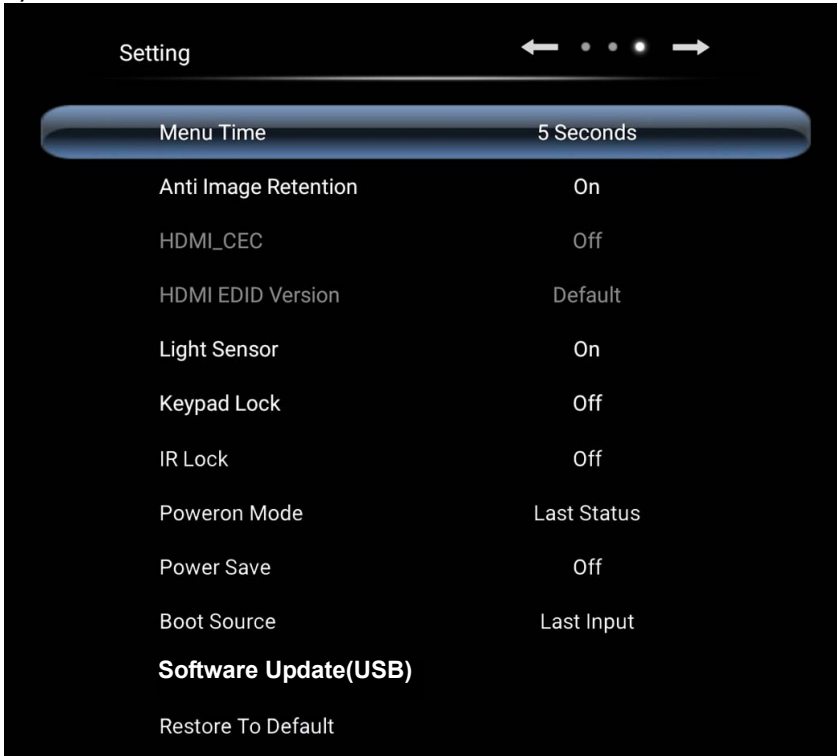

Name	Description
<b>Menu Time</b>	Adjusts the display time of the OSD menu. Available options are <b>5 Seconds, 10 Seconds, 15 Seconds, 20 Seconds, 30 Seconds, or Always.</b>
<b>Anti Image Retention</b>	Enables/disables the image retention function.
<b>HDMI_CEC</b>	Allows the user to command and control the CEC-enabled devices connected through HDMI by using only one remote control.
<b>HDMI EDID Version</b>	Adjusts the output signal's image resolution to match the display's native resolution. Available options are <b>Default, EDID 1.4, or EDID 2.0.</b>
<b>Light Sensor</b>	Enables/disables the ambient light sensor.
<b>Keypad Lock</b>	Enables/disables the buttons on the control panel.
<b>IR Lock</b>	Enables/disables the input from the remote control.

<b>Power On Mode</b>	<p>Sets the display to a specific power mode once the main power has been re-supplied after a shut-down (for example a power outage). Available options are <b>Power Off</b>, <b>Last Status</b>, or <b>Force On</b>.</p> <p> If the mode is set to <b>Power Off</b>, you need to press the <b>POWER</b> button on the control panel or on the remote control to turn the display on.</p>
<b>Power Save</b>	<p>Sets the display to reduce power consumption automatically. Available options are <b>Low</b>, <b>High</b>, or <b>Off</b>.</p> <ul style="list-style-type: none"> <li>• <b>Low:</b> If the display receives no signal or any operations for 5 minutes, the screen becomes blank until a signal is detected from the input source.</li> <li>• <b>High:</b> If the display receives no signal or any operations for 5 minutes, it automatically goes into stand-by mode.</li> <li>• <b>Off:</b> The display always keeps in power-on mode.</li> </ul>
<b>Boot Source</b>	<p>Sets the video source after a reboot. Available options are <b>Last Input</b>, <b>VGA</b>, <b>OPS</b>, <b>HDMI 1</b>, <b>HDMI 2</b>, <b>HDMI 3</b>, <b>HDMI 4</b>, and <b>Android</b>.</p>
<b>Software Update(USB)</b>	<p>Updates to a new version of the system software.</p>
<b>Restore To Default</b>	<p>Restores all parameters to the factory default settings.</p>



## Working with Android OS

To switch to the Android OS:

1. Press the **MENU** (☰) button on the control panel, or swipe in from the right edge of the screen. The sidebar menu appears at the right side of the screen.
2. Tap the **Home** (🏠) icon in the sidebar menu to open the Android home screen.

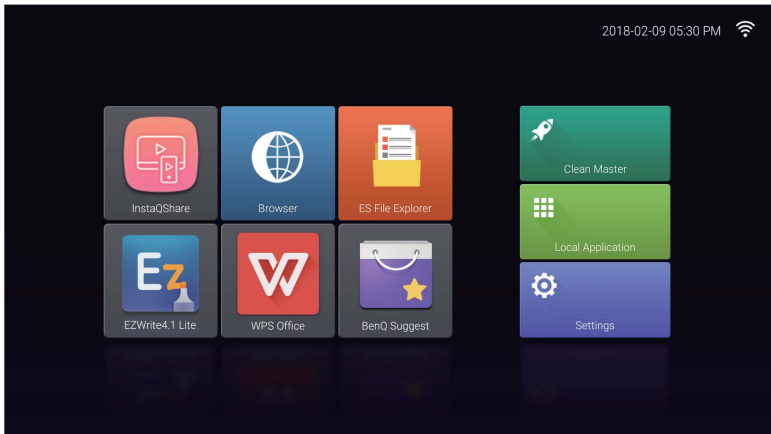

3. Select the application that you want to access.
  - Using the touch pen or your finger: Tap your desired application icon to launch the application.
  - Using the remote control: Press the 3 or 4 button to select your desired application and press the **OK** button to launch the application.



- Select **Local Application** (☐☐☐☐) to access all applications.
- To return to the Android home screen, press the **HOME** (🏠) button on the remote control, or tap **Home** (🏠) icon in the sidebar menu.
- Since the system does not support any third party applications, users may be unable to open an application even if the installation has completed successfully.

## Settings

Tap  to launch **Settings**. With this application, you can view and configure the settings for your device.

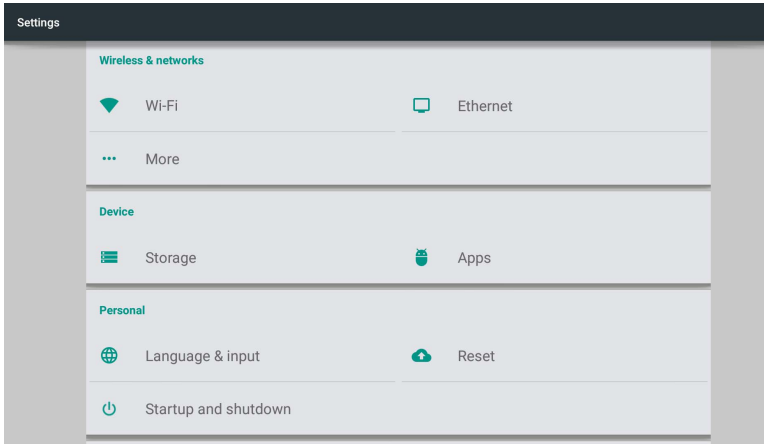

Tap the desired menu option to enter its submenu.







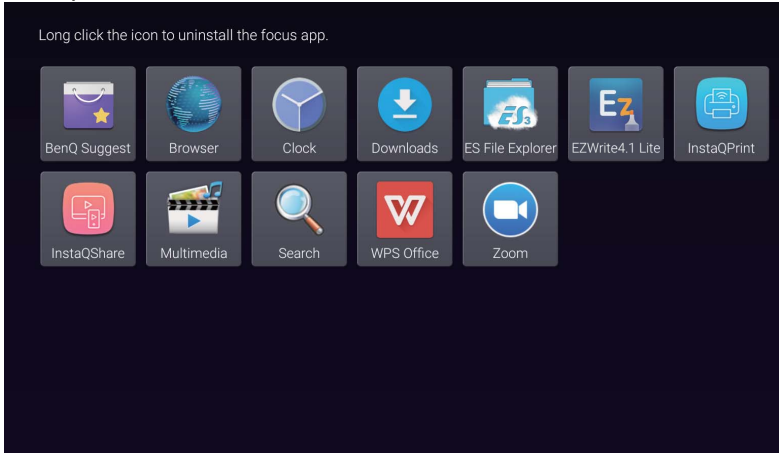

Menu Option	Description
<b>Wireless &amp; networks</b>	Select <b>Wi-Fi</b> or <b>Ethernet</b> to view the network status or configure the network connection.
<b>Device</b>	<ul style="list-style-type: none"> <li>• Select <b>Storage</b> to view the system storage information.</li> <li>• Select <b>Apps</b> to view downloaded apps, system apps, and running apps.</li> </ul>
<b>Personal</b>	<ul style="list-style-type: none"> <li>• Select <b>Language &amp; input</b> to change the system language and input.</li> <li>• Select <b>Reset</b> to restore all parameters to the factory default settings.</li> <li>• Select <b>Startup and shutdown</b> to schedule power on/off.</li> </ul>
<b>System</b>	<ul style="list-style-type: none"> <li>• Select <b>Date &amp; time</b> to set the date and time.</li> <li>• Select <b>About device</b> to update software or view the basic system information (i.e. device name, legal information, model name, software version, serial number, and build information).</li> </ul>

## Local Application

Tap  to launch **Local Application**. This menu allows you to view all the applications installed in your device.



Tap the desired app to launch the app.

Application Name/Icon	Description
<b>BenQ Suggest</b> 	Shows the Android apps suggested by BenQ. Refer to <a href="#">BenQ Suggest on page 40</a> for more information.
<b>Browser</b> 	Accesses web pages. Refer to <a href="#">Browser on page 41</a> for more information.
<b>ES File Explorer</b> 	Manages files stored on the display's internal memory and connected storage devices. Refer to <a href="#">ES File Explorer on page 42</a> for more information.
<b>EZWrite 4.1 Lite</b> 	Draws on the screen or annotates. Refer to <a href="#">EZWrite 4.1 Lite Documents</a> for more information.
<b>InstaQPrint</b> 	Prints files stored on the display's internal memory and connected storage devices, or any images shown on the display. Refer to <a href="#">InstaQPrint on page 43</a> for more information.
<b>InstaQShare</b> 	Shares files stored on the display's internal memory and connected storage devices. Refer to <a href="#">InstaQShare on page 44</a> for more information.
<b>Multimedia</b> 	Browses the multimedia files stored on the display's internal memory or connected storage devices. Refer to <a href="#">Multimedia on page 46</a> for more information.
<b>WPS Office</b> 	Reads and edits files in Office formats, including, *.doc, *.txt, *.xls, *.pdf, and *.ppt. Refer to <a href="#">WPS Office on page 47</a> for more information.
<b>Zoom</b> 	Allows a video conference meeting with any other <b>Zoom</b> users.

## BenQ Suggest

Tap  to launch **BenQ Suggest**. With this application, you can view apps suggested by BenQ for download.

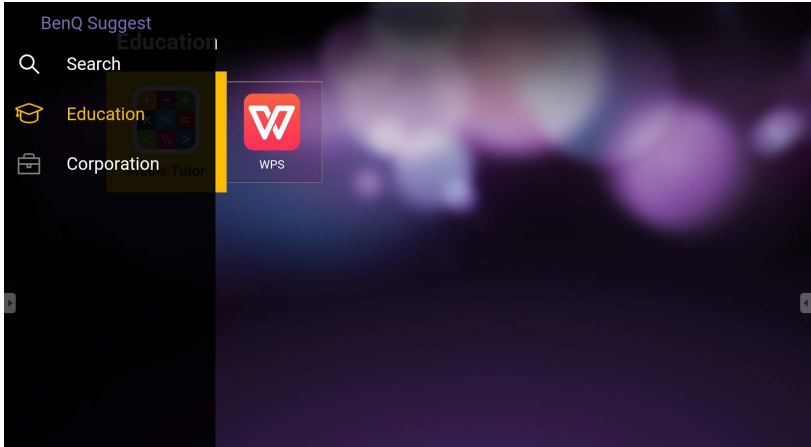

Tap the category on the left panel to browse the suggested apps. Tap an app from the selected category to view a basic description of the app.

Function	Description
<b>Search</b> (🔍)	Tap to search for an app.
<b>Education</b> (🎓)	Tap to show the suggested apps in the <b>Education</b> category.
<b>Corporation</b> (💼)	Tap to show the suggested apps in the <b>Corporation</b> category.

## Browser

Tap  to launch **Browser**. With this application, you can view web pages.



Before launching the application, make sure your display is properly connected to Internet.

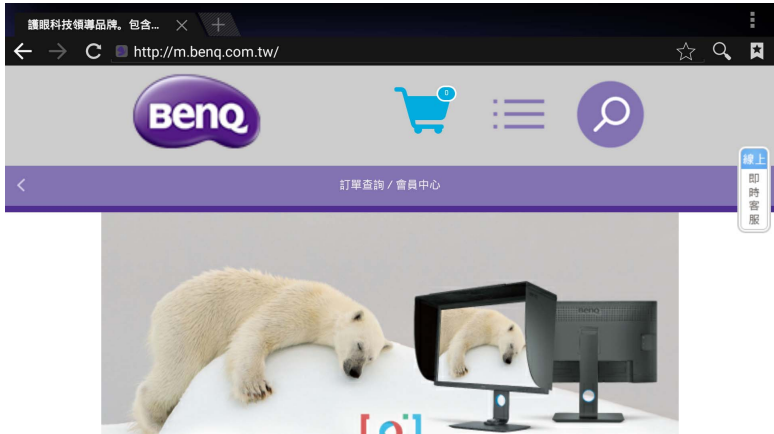

Tap the icon on the top panel to activate its function. Slide on the screen to scroll the viewed page.





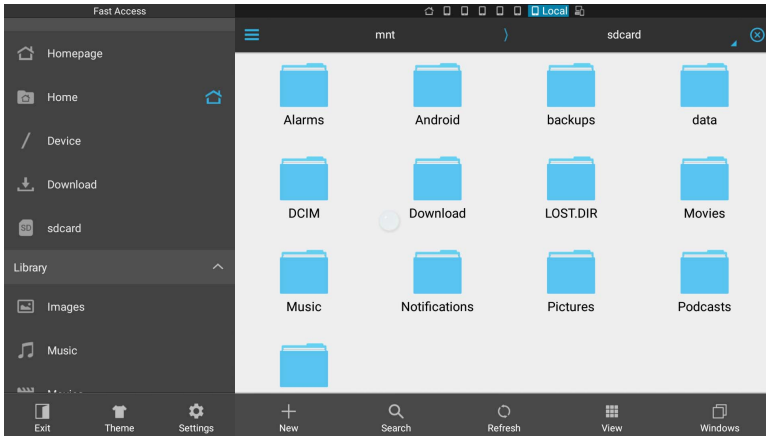

Function	Description
Address Bar	Enter the web page address to view the page.
Close (X)	Tap to close the current web page.
New (+)	Tap to open a new web page.
Settings (≡)	Tap to configure the browser settings.
Back (←)	Tap to return to the previous page.
Next (→)	Tap to go to the next page.
Refresh (C)	Tap to reload the current web page.
Favorite (☆)	Tap to save the current web page to bookmarks.
Search (Q)	Tap to search the Internet.
Bookmarks (★)	Tap to select bookmarks, history, or saved favorite web pages to visit.

## ES File Explorer

Tap  to launch **ES File Explorer**. With this application, you can manage the files and apps.



Tap the category on the left panel and select the desired folder to browse. Tap a file in the folder, then you can view or edit the file according to the available options.

Function	Description
<b>Exit</b> (  )	Tap to close <b>ES File Explorer</b> .
<b>Theme</b> (  )	Tap to change different theme.
<b>Settings</b> (  )	Tap to access more advanced options.
<b>New</b> (+)	Tap to create a new folder.
<b>Search</b> (  )	Tap to search for files in the internal memory or external device.
<b>Refresh</b> (  )	Tap to reload the current page.
<b>View</b> (  )	Tap to toggle between list view or icons view.
<b>Windows</b> (  )	Tap to switch between open windows.

## InstaQPrint

Tap  to launch **InstaQPrint**. With this application, you can print a file or website image using a Wi-Fi or remote printer.



- Before launching the application, make sure your display is properly connected to Internet.
- For the list of supported printers, see [https://printhead.com/list\\_of\\_supported\\_printers.php](https://printhead.com/list_of_supported_printers.php).



1. Tap the option on the left panel and browse and select the desired file, photo, page, or image you want to print.
2. Tap **Manage Printers** to choose which printer that you want to use.
3. To select a printer:
  - Tap an option from the list of available printers on the left panel.
  - Tap **Scan for Wi-Fi Printers** to search for printers automatically.
  - Tap **Manual Setup** to add a new printer manually.

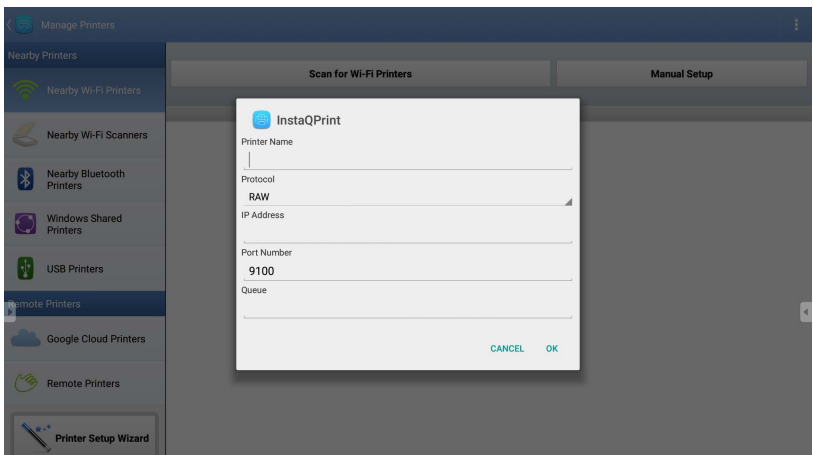

## InstaQShare

Tap  to launch **InstaQShare**. With this application, you can mirror the display's screen on your smartphone or tablet for hands-on annotation, mirror the screen of your smartphone or tablet on the display, or transform your smartphone or tablet into a remote control for the display.





Before launching the application, make sure your display is properly connected to Internet.

*Seamless Sharing Across all Fields*

*InstaQShare facilitates intuitive and instant wireless presentation that supports smooth content transmission. This makes business or education presentation easier and simpler than ever.*

RM7501K: 571363









**Network Connect**

Make sure your device is connected to the same local area network with RM7501K.



**Install App**



Click to enlarge

Visit "<http://192.168.31.179:8000>" with web browser or scan the QR-code to download and install app.



**Click to connect**

Launch InstaQShare and click "RM7501K" to connect.

 Setting

To use **InstaQShare**:

1. Make sure your mobile device (such as smartphone or tablet) and the display are connected to the same network.
2. Scan the QR code to download and install the **InstaQShare** app on your mobile device.
3. Open the **InstaQShare** app on your mobile device, and then click the **InstaQShare** ID name that you want to connect to.
4. Enter the password shown on the upper right corner of the display.
5. Once the mobile device has successfully connected to the display, a confirmation message will appear on the display. Tap **Allow** on the display to confirm the connection.
6. Once connected you can:
  - Mirror the display's screen on your mobile device, by tapping **TV Mirror** on your mobile device.
  - Mirror the device's screen on the display, by tapping  on your mobile device.
  - Operate the display by using your mobile device as a remote control.



Once connected, any operations on the display or mobile device will also show up on your mobile device and display.



You can also tap **Setting** (⚙️) in the lower right corner of the display to modify the settings for **InstaQShare**, such as the **InstaQShare** ID name, password, or mirroring confirmation message.

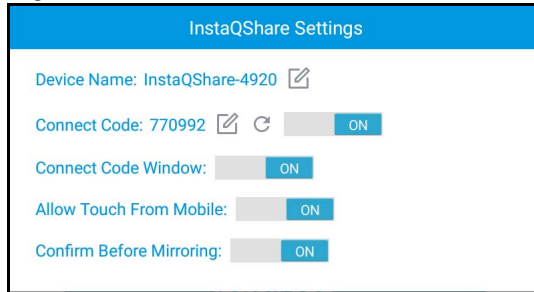

## Multimedia

Tap  to launch **Multimedia**. With this application, you can browse the photos, songs, or videos stored on the internal memory or connected storage devices.

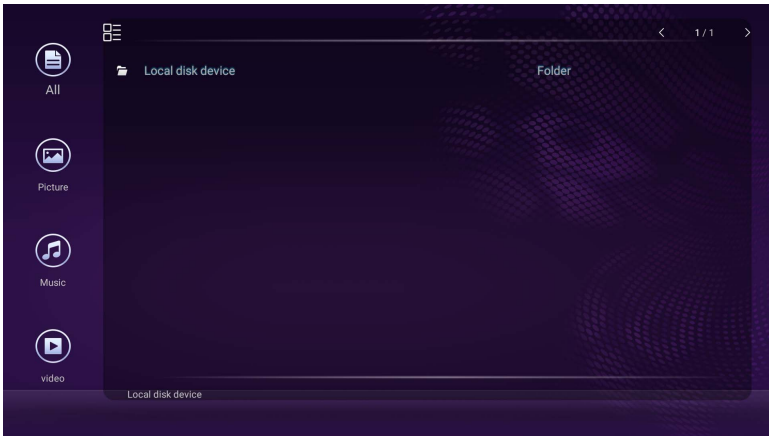

- Tap **All** to view the all files.
- Tap **Picture** to view the photos. Tap the desired photo to view it in full screen.
- Tap **Music** to view the audio files. Tap the desired audio file to play the song/audio clip.
- Tap **Video** to view the videos. Tap the desired video file to play the video clip.

### Supported multimedia file formats

#### Video

Supported File Formats	File Extension
MPEG1 / MPEG2 / MPEG4 / H264 / RM / RMVB / MOV / MJPEG / VC1 / DIVX / FLV	.avi / .mpg / .dat / .vob / .div / .mov / .mkv / .rm / .rmvb / .mp4 / .mjpeg / .ts / .trp / .wmv / .asf / .flv

#### Photo

Supported File Formats	File Extension
JPEG / BMP / PNG	.jpg / .bmp / .png

#### Audio

Supported File Formats	File Extension
WMA / MP3/ M4A (AAC)	.wma / .mp3 / .m4a

## WPS Office

Tap  to launch **WPS Office**. With this application, you can open document files including PDFs as well as Microsoft Word, PowerPoint and Excel documents.

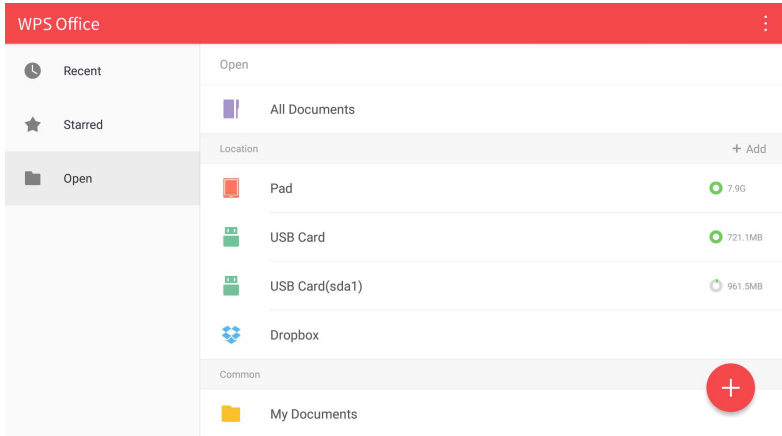

To edit a file with **WPS Office**:

1. Tap **Open** () on the left panel to browse and open a file located in either the display's internal memory, an external storage device, or cloud storage.
2. Tap the function menu on the top panel to access the file format's various functions.



The description below is for a PowerPoint file, the function menus for other file formats will vary.

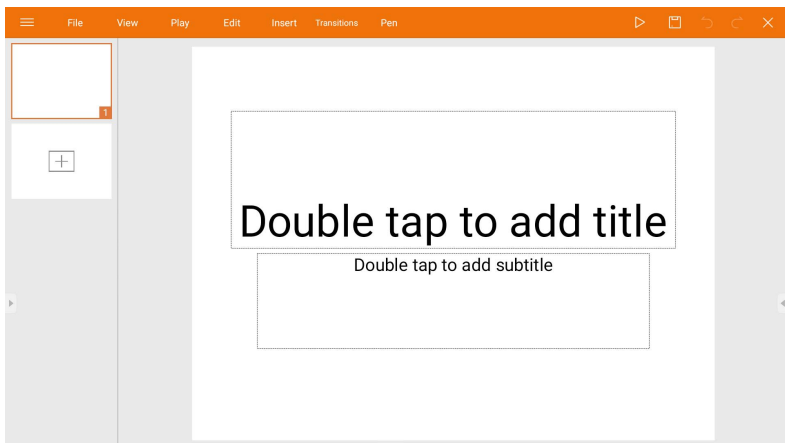

Function	Description
<b>File</b>	Tap to open, save, share, print, and manage your presentations.
<b>View</b>	Tap to change or edit the presentation views.

<b>Play</b>	Tap to start or set up a slide show.
<b>Edit</b>	Tap to edit the content or format of the slides.
<b>Insert</b>	Tap to insert tables, pictures, charts, comments, video, or audio.
<b>Transitions</b>	Tap to apply or adjust the timing of a transition.
<b>Pen</b>	Tap to write, draw, paint or sketch to the slides.
<b>Play (▶)</b>	Tap to start a slide show.
<b>Save As (☐)</b>	Tap to save the presentation file on either the display's internal memory, an external storage device, or cloud storage.
<b>Undo (↶)</b>	Tap to undo an action.
<b>Redo (↷)</b>	Tap to redo the last action.
<b>Close (✕)</b>	Tap to close the presentation file.
<b>Back (←)</b>	Tap to return to the previous page.
<b>Next (→)</b>	Tap to go to the next page.
<b>Exit (⏏)</b>	Tap to exit <b>WPS Office</b> .

## Supported Office versions and file formats

Supported Office versions: 97 / 2000 / XP / 2003 / 2007 / 2010

Supported Office software formats:

Office Software	Supported File Formats
Word	wps / wpt / doc / docx / dot / dotx / txt / log / irc / c / cpp / h / asm / s / java / asp / bat / bas / prg / cmd
Excel	et / ett / xls / xlsx / xlt / xltx / csv / xlsx / xltm
PowerPoint	ppt / pptx

# Product information

## Specifications

Item		Specifications	
		RM7501K	RM8601K
LCD panel	Backlight	DLED	DLED
	Panel size	75"	86"
	Pixel pitch (mm)	0.429 (H) x 0.429 (V)	0.4935 (H) x 0.4935 (V)
	Native resolution (pixels)	UHD 3840 x 2160	UHD 3840 x 2160
	Brightness (cd/m <sup>2</sup> ) (typical)	350	400
	Contrast (typical)	1200:1	
	Response time (ms) (typical)	8	
	Panel Bit	10 bit	10 bit
Touch	Technology	IR Touch	
	Resolution	32767 x 32767	
	Capacity	10 points (Varies from operating systems and applications)	
	Accuracy	±1mm over 90% of touchable area	
	Touch Output	x2	
	Operating System	Windows XP/Vista 7, 8,10/Linux/Mac/Android/Chrome	
Panel glass	Tempered glass (thickness, Mohs scale)	4mm, 7H	
	Anti bacteria coating	X	
	AG80	O	
Input	Computer	VGA (D-Sub 15-pin), HDMI 2.0 x4	
	Video	HDMI 2.0 x4 (HDML 2.0 MHL x1, share with HDMI)	
	Audio	Mic-in (3.5 mm Jack)	
	USB	Type-A x4 (2.0 x 2; 3.0 x 2), Type-B x1	
	Control	RS-232 (D-Sub 9-pin)	
	OPS Option Slot	Open pluggable specification (Intel OPS standard) x 1 (19V/4.5A)	
Output	Computer	HDMI 2.0	
	Video	HDMI 2.0	
	Audio	PC-audio (3.5 mm jack)	
	Control	RS-232 (D-Sub 9-pin)	
Audio	Audio W (Amp)	20W x 2	
	Internal speaker	O	

Power	Supply	100 - 240V AC, 50/60 Hz, 5.0A	100 - 240V AC, 50/60 Hz, 5.5A
	Consumption Max.	460W	500W
	Consumption Standby	≤0.5W	
Environment	Operating Temperature	0°C - 40°C	
	Operating Humidity	20% ~ 80% RH Non-Condensing	20% ~ 80% RH Non-Condensing
	Storage Temperature	-10°C - 60°C	
	Storage Humidity	10% ~ 60% RH Non-Condensing	10% ~ 60% RH Non-Condensing
	Display Orientation	Landscape	
Mechanical	Weight (without packing / with packing)	60.8kg / 72kg ±1.5Kg	86.2kg / 99kg ±1.5Kg
	Dimensions (W x H x D) (mm)	1736.8 x 1085.3 x 137.1	1990 x 1231 x 140.9
	Bezel Dimension - T/B/L/R (mm)	28 / 98 / 28 / 28	
Feature	DVI daisy chain	X	X
	RS232 control daisy chain	X	X
	Image setting	O	O
	Picture mode	O	O
	Sharpness enhancement	O	O
	Proof of image retention	O	O
	Dimming control	X	X
	Blank	O	O
	Freeze	O	O
	10-bit color processing	O	O
	Built-in video wall support	X	X
	Scheduling	O	O
	Source / volume control	O	O
	HDMI-HDCP	O	O
	HDMI-MHL	O	O
	De-Interlacing / Comb Filter	X	X
Ambient light sensor	O	O	



- Specifications and functions are subject to change without notice.
- To make sure that the touch function works properly on Mac OS X 10.10, you are recommended to perform screen calibration first. Contact BenQ dealer for the required calibration utility.

Item		RM7501K	RM8601K
System	CPU	ARM Cortex A53 1.4GHz, Quad Core (MSD6A828)	
	System Memory	2GB	
	Storage	32GB	
	OS	Android 5.0	



- OS: This Android 5.0 operating system is not standard Android, so access to Google Play™ is not available. APK cannot be installed in the default location unless given permission by the management units. Contact your BenQ dealer for the required support for the management permission. Without management permission, installing function won't work. There is no guarantee that the self-installed APK can function normally.
- Storage: Content storage may vary by the product supplied for your region. Pre-installed system and apps may take up some space.

# Dimensions

## RM7501K

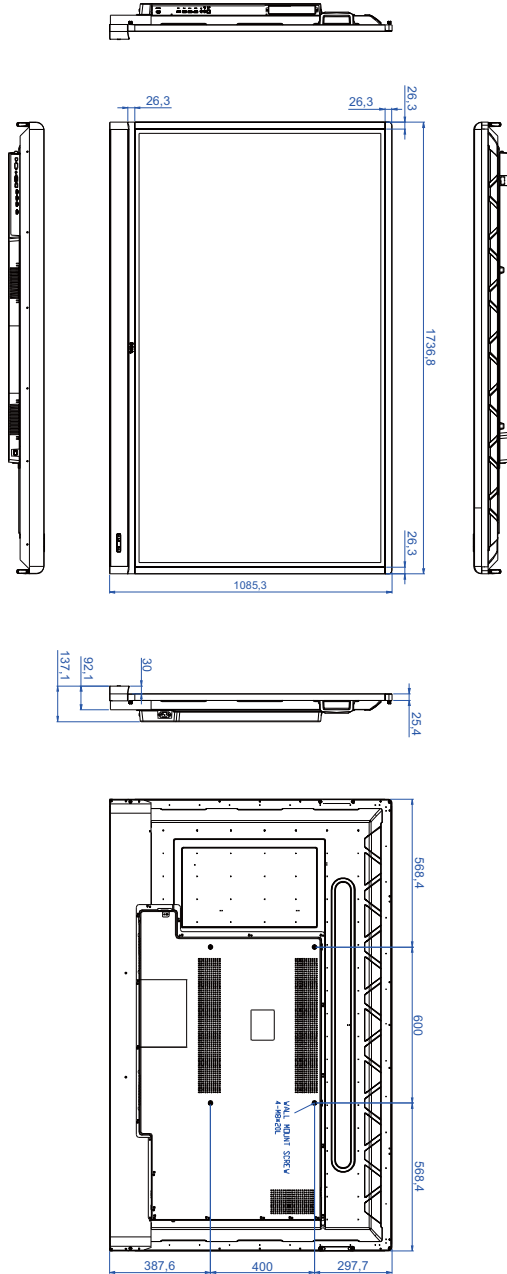

Unit: mm



RM8601K

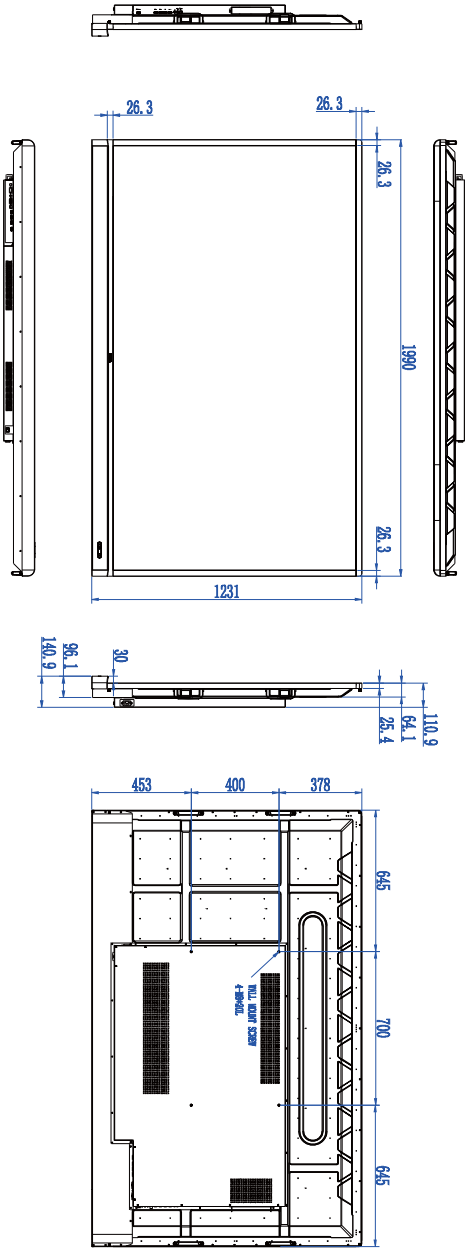

Unit: mm

## Supported input

signal resolution

### RM7501K & RM8601K

Resolution	Input source		
	HDMI 1/ HDMI 2/ HDMI 3/ OPS	HDMI 4	VGA
640 x 350 @ 85Hz	○	○	
640 x 480 @ 85Hz	○	○	
640 x 480 @ 60Hz	○	○	○
720 x 400 @ 85Hz	○	○	
720 x 400 @ 70Hz			○
720 x 576 @ 60Hz	○	○	
800 x 600 @ 85Hz	○	○	
800 x 600 @ 60Hz			○
1024 x 768 @ 85Hz	○	○	
1024 x 768 @ 60Hz			○
1152 x 864 @ 75Hz	○	○	
1280 x 720 @ 120Hz	○	○	
1280 x 720 @ 60Hz	○	○	○
1280 x 800 @ 60Hz			○
1280 x 960 @ 60Hz	○	○	
1280 x 1024 @ 85Hz	○	○	
1360 x 768 @ 60Hz			○
1366 x 768 @ 60Hz			○
1600 x 900 @ 60Hz			○
1600 x 1200 @ 60Hz	○	○	
1920 x 1080 @ 60Hz	○	○	○
3840 x 2160 @ 30Hz	○	○	
3840 x 2160 @ 60Hz		○	



• ○: supported

• Blank: not supported

# Troubleshooting

Problem	Solution
No picture	<p>Check the following:</p> <ul style="list-style-type: none"> <li>• Is the display turned on? Check the power indicator of the display.</li> <li>• Is the signal source device turned on? Turn on the device and try again.</li> <li>• Are there any loose cable connections? Make sure that all cables are connected firmly.</li> <li>• Have you chosen an unsupported output resolution on the computer? Refer to <a href="#">Supported input on page 54</a> to select a supported resolution and try again.</li> <li>• Have you chosen an unsupported output resolution on the DVD or Blu-ray disc player? Refer to <a href="#">Supported input on page 54</a> to select a supported resolution and try again.</li> </ul>
No sound	<p>Check the following:</p> <ul style="list-style-type: none"> <li>• Have you turned on the mute function on the display or the input source device? Turn off the mute function or increase the audio volume level and try again.</li> <li>• Are there any loose cable connections? Make sure that all cables are connected firmly.</li> </ul>
The computer input image looks strange	<ul style="list-style-type: none"> <li>• Have you chosen an unsupported output resolution on the computer? Refer to <a href="#">Supported input on page 54</a> to select a supported resolution and try again.</li> <li>• Use the <b>Auto Tune</b> function (See <a href="#">Picture menu on page 33</a>) to let the display automatically optimize the display of computer image.</li> <li>• If the result of the <b>Auto Tune</b> function is not satisfactory, use the <b>Clock</b>, <b>Phase</b>, <b>Horizontal Position</b>, and <b>Vertical Position</b> functions to manually adjust the image.</li> </ul>
The displayed image looks blurry or grainy	<ul style="list-style-type: none"> <li>• Use the <b>Default</b> function (See <a href="#">Setting menu on page 35</a>) to set the output signal's image resolution match to the display's native resolution.</li> <li>• If the result of the <b>Default</b> function is not satisfactory, use the <b>EDID 1.4</b> or <b>EDID 2.0</b> functions to manually adjust the resolution.</li> </ul>
The control panel buttons do not work	<p>Have you locked the control panel buttons? Refer to the <b>Keypad Lock</b> function (See <a href="#">Setting menu on page 35</a>) to unlock the buttons and try again.</p>

---

The remote control does not work	<ul style="list-style-type: none"><li>• Check for incorrect battery orientation.</li><li>• Check for dead batteries.</li><li>• Check your distance and angle from the display.</li><li>• Check whether remote control is properly being pointed at the display's remote control sensor window.</li><li>• Check for any obstacle between the remote control and the remote control sensor window.</li><li>• Check that the remote control sensor window is not under strong fluorescent lighting, or in direct sunlight.</li><li>• Check for any devices (computer or personal digital assistant, PDA) nearby that transmit infrared signals which may cause interference to signal transmission between the remote control and the display. Turn off the infrared function of these devices.</li></ul>
USB Function	<p>When working with the environment of ESD interference, it is normal that the USB connection will be disconnected. The users have to restart the USB connection manually.</p>