

Dell OptiPlex 7760 All-in-One

Setup and specifications guide



Notes, cautions, and warnings

 | **NOTE:** A NOTE indicates important information that helps you make better use of your product.

 | **CAUTION:** A CAUTION indicates either potential damage to hardware or loss of data and tells you how to avoid the problem.

 | **WARNING:** A WARNING indicates a potential for property damage, personal injury, or death.

© 2018 Dell Inc. or its subsidiaries. All rights reserved. Dell, EMC, and other trademarks are trademarks of Dell Inc. or its subsidiaries. Other trademarks may be trademarks of their respective owners.

Contents

1 Set up your computer	5
2 Chassis	9
Front chassis view.....	9
Back chassis view.....	10
Left chassis view.....	11
Right chassis view.....	12
Bottom chassis view.....	12
Transform.....	12
Height Adjustable stand.....	13
Articulating stand.....	13
Pop-Up Camera - optional.....	14
3 System specifications	15
Processor.....	15
Memory.....	16
Storage.....	16
Audio.....	17
Video controller.....	17
Web camera.....	18
Communications - Integrated.....	18
External ports and connectors.....	18
Display.....	19
Power.....	20
Physical system dimensions.....	21
Environmental.....	23
4 System setup	24
BIOS overview.....	24
Navigation keys.....	25
Boot Sequence.....	25
Entering BIOS setup program.....	25
General screen options.....	26
System configuration screen options.....	27
Security screen options.....	28
Secure boot screen options.....	30
Intel Software Guard Extensions screen options.....	31
Performance screen options.....	31
Power Management screen options.....	32
POST Behavior screen options.....	33
Manageability.....	33
Virtualization support screen options.....	34
Wireless screen options.....	34

Maintenance screen options.....	34
System Log screen options.....	35
Advanced configuration options.....	35
System and setup password.....	35
Assigning a system password and setup password.....	35
Deleting or changing an existing system setup password.....	36
5 Software.....	37
Supported operating systems.....	37
Downloading drivers.....	37
Intel chipset drivers.....	38
Display adapter drivers.....	40
Audio drivers.....	40
Network drivers.....	40
Camera drivers.....	40
Storage drivers.....	40
Security drivers.....	41
Bluetooth drivers.....	41
USB drivers.....	41
6 Getting help.....	42
Contacting Dell.....	42

Set up your computer

- 1 Set up the stand.

Height Adjustable stand

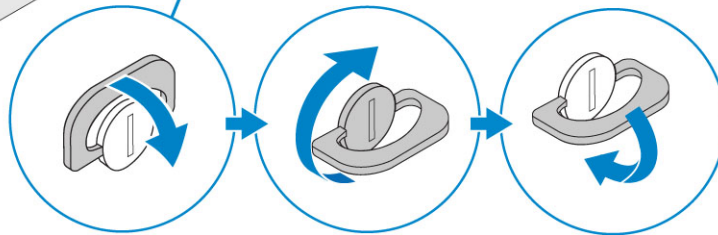
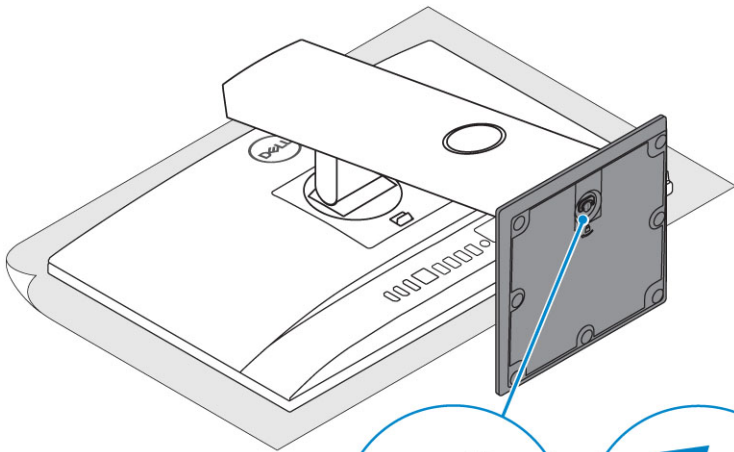
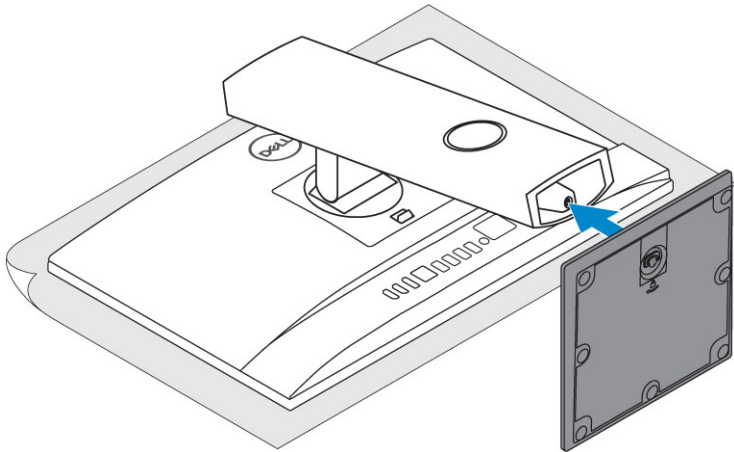
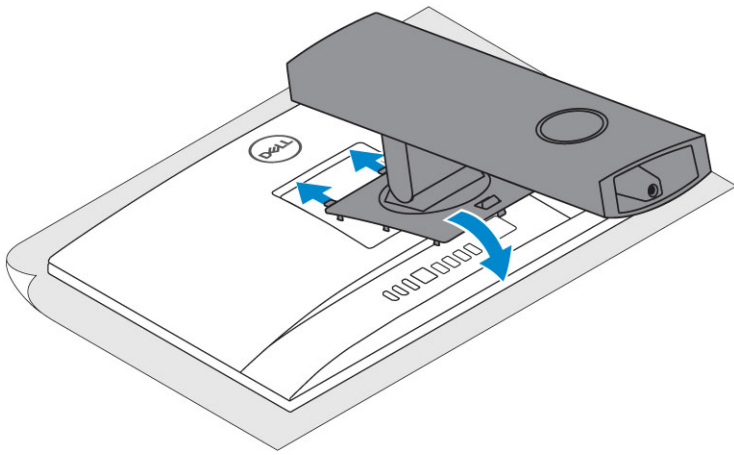

Articulating stand

NOTE: The stand comes assembled in the box.

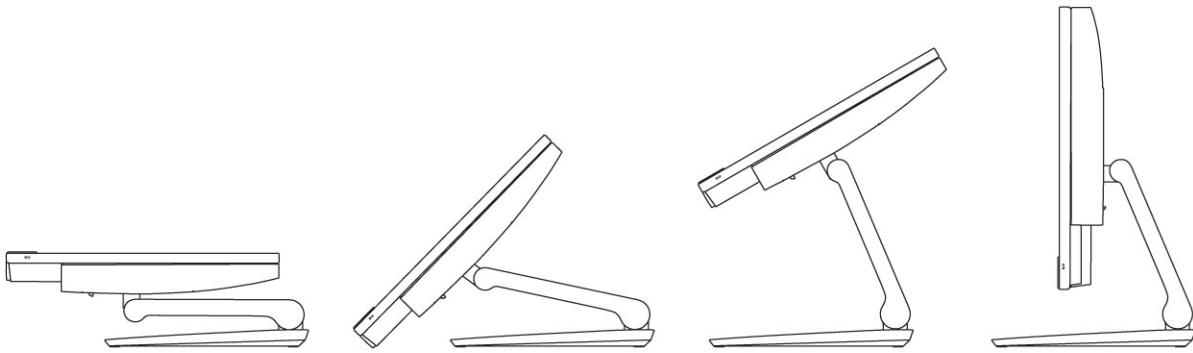

2 Set up the keyboard and mouse.

NOTE: See the documentation that shipped with the keyboard and mouse.

3 Route the cable through the stand, then connect the power cable.

Height Adjustable stand

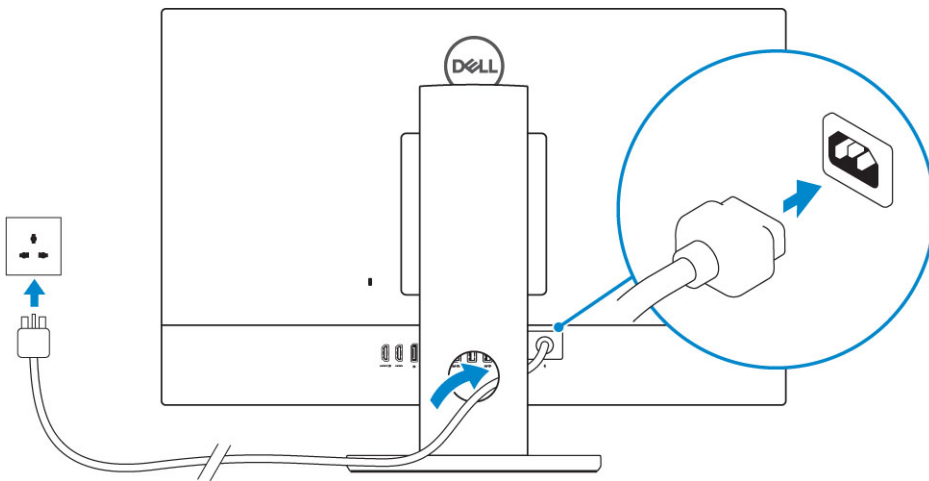

Articulating stand

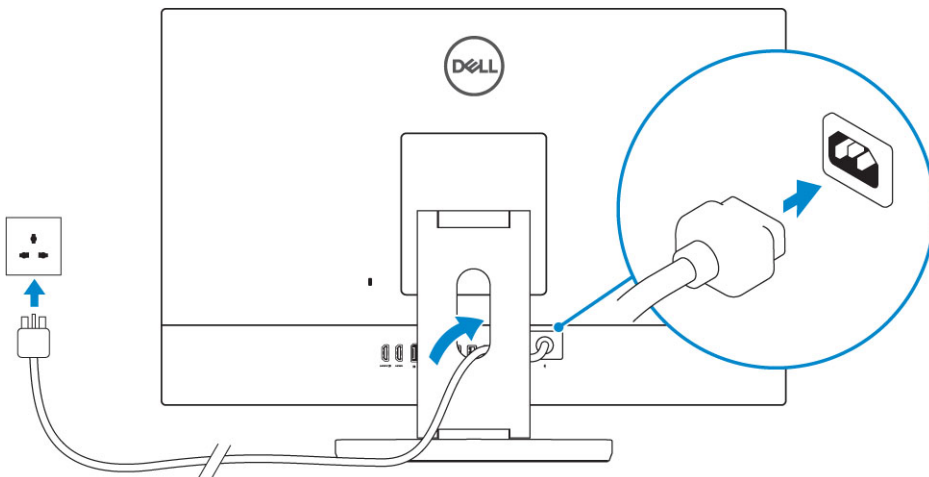

4 Press the power button.

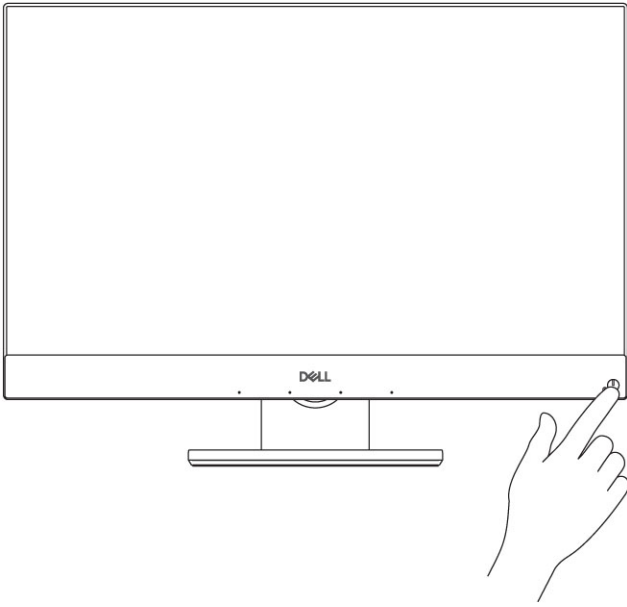

Chassis

Topics:

- Front chassis view
- Back chassis view
- Left chassis view
- Right chassis view
- Bottom chassis view
- Transform
- Pop-Up Camera - optional

Front chassis view

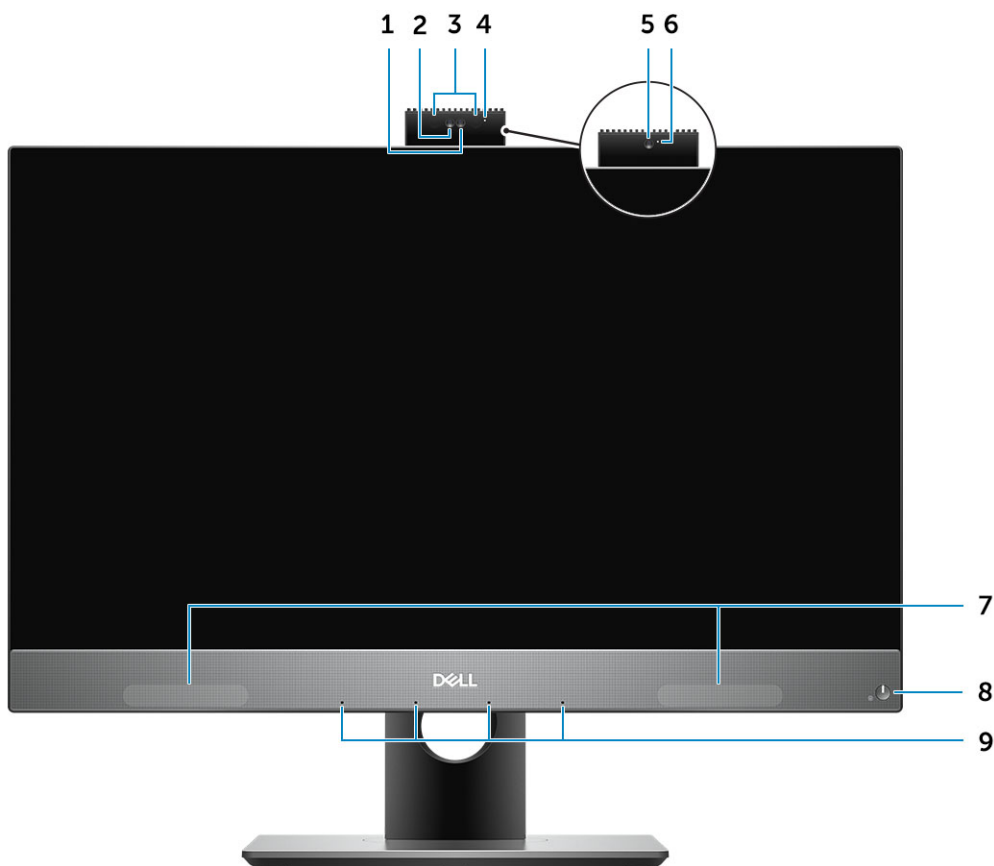

- | | | | |
|---|--|---|-------------------------------------|
| 1 | Full high-definition (FHD) camera (optional) | 2 | FHD infrared (IR) camera (optional) |
| 3 | IR emitters (optional) | 4 | Camera status light (optional) |
| 5 | FHD camera (optional) | 6 | Camera status light (optional) |

- 7 Speakers
- 9 4 Mic Array

- 8 Power button/Power-status light

Back chassis view



- | | |
|--------------|----------------------|
| 1 Back cover | 2 Security lock slot |
| 3 Base cover | 4 Stand |

Base cover

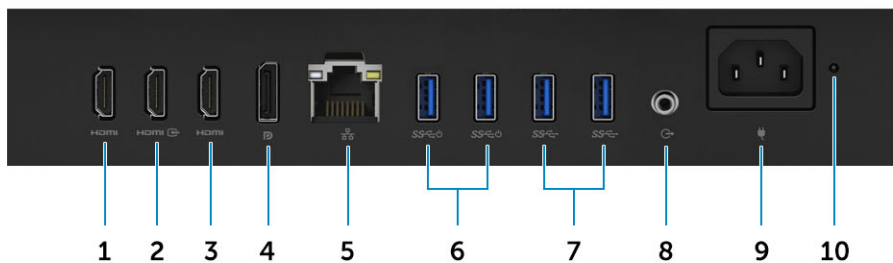

- | | |
|---|--|
| 1 HDMI-out port (with discrete graphics card) | 2 HDMI-in port (optional) |
| 3 HDMI-out port (with integrated graphics card) | 4 DisplayPort |
| 5 Network port | 6 USB 3.1 Gen 1 ports with Power on/ Wake-up support |
| 7 USB 3.1 Gen 1 ports | 8 Audio out port |
| 9 Power connector port | 10 Power supply diagnostic light |

Left chassis view

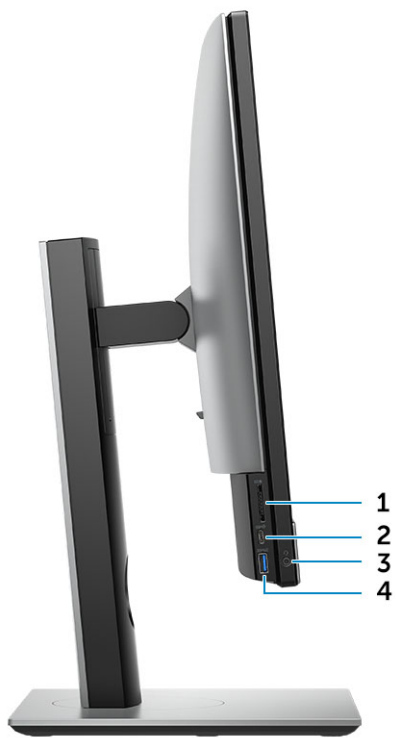

- 1 SD card reader
- 3 Headset/Universal audio port

- 2 USB 3.1 Gen 2 Type-C port
- 4 USB 3.1 Gen 1 port with PowerShare

Right chassis view

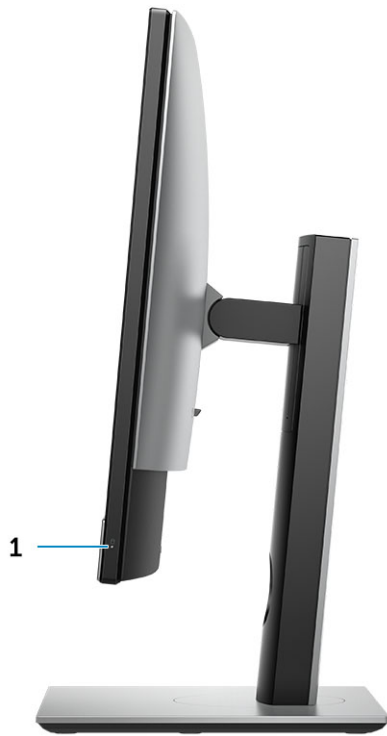

- 1 Hard drive activity light

Bottom chassis view



- 1 Service Tag label

- 2 Display Built-in Self Test button/Video input selection

Transform

Height Adjustable stand



Articulating stand

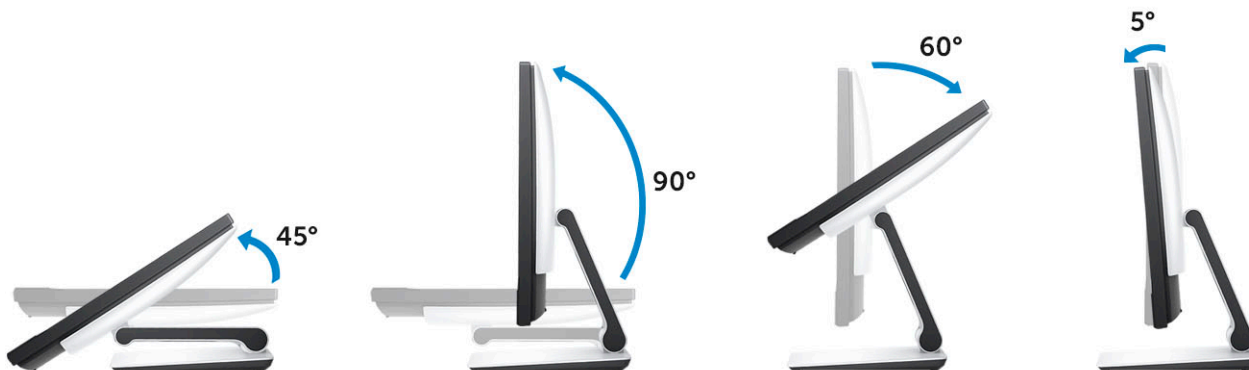

Pop-Up Camera - optional

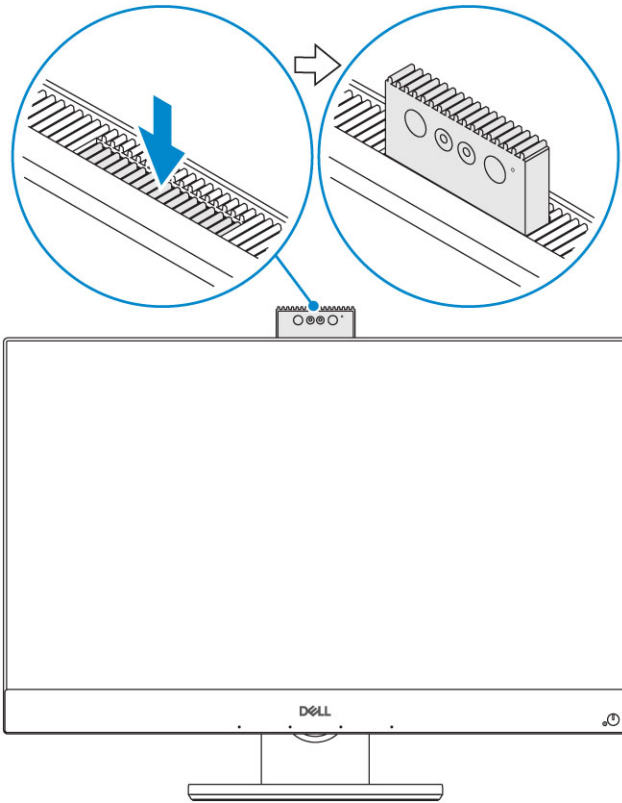

NOTE: Extend the camera while using any camera function so that the camera is not blocked.

System specifications

NOTE: Offerings may vary by region. The following specifications are only those required by law to ship with your computer. For more information about the configuration of your computer, go to Help and Support in your Windows operating system and select the option to view information about your computer.

Topics:

- [Processor](#)
- [Memory](#)
- [Storage](#)
- [Audio](#)
- [Video controller](#)
- [Web camera](#)
- [Communications - Integrated](#)
- [External ports and connectors](#)
- [Display](#)
- [Power](#)
- [Physical system dimensions](#)
- [Environmental](#)

Processor

Global Standard Products (GSP) are a subset of Dell's relationship products that are managed for availability and synchronized transitions on a worldwide basis. They ensure the same platform is available for purchase globally. This allows customers to reduce the number of configurations managed on a worldwide basis, thereby reducing their costs. They also enable companies to implement global IT standards by locking in specific product configurations worldwide. The following GSP processors identified below will be made available to Dell customers.

Device Guard (DG) and Credential Guard (CG) are the security features available on Windows 10 Enterprise. Device Guard is a combination of enterprise-related hardware and software security features, when configured together, will lock a device down so that it can only run trusted applications. Credential Guard uses virtualization-based security to isolate secrets (credentials) so that only privileged system software can access them. Unauthorized access to these secrets can lead to credential theft attacks. Credential Guard prevents these attacks by protecting NTLM password hashes and Kerberos Ticket Granting Tickets.

NOTE: Processor numbers are not a measure of performance. Processor availability is subject to change and may vary by region/country.

Table 1. Processor specifications

Type
Intel Core i3 - 8100 (4 Cores/6MB/4T/3.6GHz/65W)
Intel Core i3 - 8300 (4 Cores/8MB/4T/3.7GHz/65W)
Intel Core i5 - 8400 (6 Cores/9MB/6T/up to 4.0GHz/65W)
Intel Core i5 - 8500 (6 Cores/9MB/6T/up to 4.1GHz/65W)

Type

Intel Core i5 - 8600 (6 Cores/9MB/6T/up to 4.3GHz/65W)

Intel Core i7 - 8700 (6 Cores/12MB/12T/up to 4.6GHz/65W)

Memory

Table 2. Memory specifications

Minimum memory configuration	4 GB (1 x 4GB module)
Maximum memory configuration	32 GB
Number of slots	2 SODIMM
Maximum memory supported per slot	16 GB
Memory options	<ul style="list-style-type: none">• 4 GB - 1 x 4 GB• 8 GB - 1 x 8 GB• 8 GB - 2 x 4 GB• 16 GB - 2 x 8 GB• 16 GB - 1 x 16 GB• 32 GB - 2 x 16 GB
Type	DDR4 SDRAM Non-ECC memory
Speed	<ul style="list-style-type: none">• 2666 MHz• 2400 MHz on i3 processor

Storage

Table 3. Storage specifications

Primary/Boot drive	Secondary drive	Capacity
One Solid-State Drive (SSD)	M.2 2280	<ul style="list-style-type: none">• Up to 512 GB• Up to 1 TB
One 2.5" Hard-Disk Drive (HDD)	Approximately (2.760 x 3.959 x 0.374 inches)	Up to 2 TB
One 2.5" Solid-State Hybrid Drive (SSHD)	Approximately (2.760 x 3.959 x 0.276 inches)	Up to 1 TB

Table 4. Dual Storage Combinations

Primary/Boot drive	Secondary drive
1 x M.2 Drive	NA
1 x M.2 Drive	1 x 2.5" Drive
1 x 2.5" Drive	NA
1 x 2.5" HDD with M.2 Optane	NA

NOTE: Supports RAID 0 and 1 with M.2 and 2.5" HDD.

Audio

Table 5. Audio

Integrated Realtek ALC3289 High Definition Audio

High Definition Stereo support	Yes
Number of channels	2
Number of Bits / Audio resolution	16, 20, and 24-bit resolution
Sampling rate (recording/playback)	Support 44.1K/48K/96K/192 kHz sample rates
Signal to Noise Ratio	98 dB DAC outputs, 92 dB for ADC inputs
Analog Audio	Yes
Waves MaxxAudio Pro	Yes

Audio Jack Impedance

Microphone	40K ohm~60K ohm
Line-In	N/A
Line-Out	100~150 ohm
Headphone	1~4 ohm
Internal Speaker Power Rating	3 Watt (average) / 4 Watt (peak)

Video controller

Table 6. Video

Controller	Type	Graphics memory type
Intel UHD Graphics 630	UMA	Integrated
NVIDIA GeForce GTX 1050, 4GB	Discrete	GDDR5

Table 7. Video port resolution matrix

	DisplayPort 1.2	HDMI 1.4	HDMI 2.0b
Max resolution - Single display	4096x2160	<ul style="list-style-type: none">2560x1600 @ 24Hz4096x2160 @ 24Hz	<ul style="list-style-type: none">2560x1600 @ 24Hz4096x2160 @ 24Hz
Max resolution - Dual MST	<ul style="list-style-type: none">2560x16003440x1440	N/A	N/A
Max Resolution - Dual MST	2560x1080	N/A	N/A

All resolutions shown at 24bpp and unless specifically stated are @60Hz refresh

Web camera

Table 8. Web camera(optional)

Maximum Resolution	2.0 MP
Camera type	<ul style="list-style-type: none">• FHD• FHD + Infrared (IR)
Video Resolution	<ul style="list-style-type: none">• FHD - 1080p• FHD + IR - 1080p + VGA
Diagonal Viewing Angle	<ul style="list-style-type: none">• FHD - 74.9°• IR - 88°
Power Saving Support	Suspend, Hibernation
Automatic Image Control	Automatic Exposure Control (AE) Automatic White Balance Control (AWB) Automatic Gain Control (AGC)
Webcam Mechanical Privacy	Pop up camera

Communications - Integrated

Table 9. Communications - Integrated

Network adapter	Integrated Intel i219-LM 10/100/1000 Mb/s Ethernet (RJ-45) with Intel Remote Wake UP and PXE
-----------------	---

External ports and connectors

Table 10. External ports and connectors

USB 3.1 Gen 1 (Side/Rear/Internal)	1/4/0 <ul style="list-style-type: none">• One USB 3.1 Gen 1 port with PowerShare (side)• Two USB 3.1 Gen 1 ports with Power on/Wake-up support (rear)• Two USB 3.1 Gen 1 ports (rear)
USB 3.1 Gen 2 (Side/Rear/Internal)	1/0/0 One USB 3.1 Gen 2 Type-C port (side)
Network Connector (RJ-45)	1 Rear
HDMI 1.4 Out	1 Rear (Integrated graphics configurations)
HDMI In	1 Rear

HDMI 2.0 Out	1 Rear (Discrete graphics configurations)
DisplayPort 1.2	1 Rear
Universal Audio Jack	1 Side
Line-Out for headphones or speakers	1 Rear
Integrated Antenna	Built-in
Memory card reader	Integrated SD-card slot
Bluetooth	Optional via WLAN

Display

Table 11. Display specifications

Type	<ul style="list-style-type: none"> • Full HD (FHD) touch • Full HD (FHD) Non-Touch • 4K Ultra HD non-touch
Screen size (Diagonal)	27 inch
Screen technology	IPS
Display	WLED
Native resolution	<ul style="list-style-type: none"> • FHD - 1920 x 1080 • 4K UHD - 3840 x 2160
High definition	<ul style="list-style-type: none"> • Full HD • Ultra HD
Luminance	<ul style="list-style-type: none"> • FHD Touch - 200 cd/m • FHD Non-touch - 250 cd/m • 4K UHD Non-touch - 350 cd/m
Active area dimensions	<ul style="list-style-type: none"> • FHD - 597.89 mm x 336.31 mm • UHD - 596.74 mm x 335.66 mm
Height	<ul style="list-style-type: none"> • FHD - 336.31 mm • UHD - 335.66 mm
Width	<ul style="list-style-type: none"> • FHD - 597.89 mm • UHD - 596.74 mm
Megapixels	<ul style="list-style-type: none"> • FHD - 2M • 4K UHD - 8.3M
Pixels Per Inch (PPI)	<ul style="list-style-type: none"> • FHD - 82

Pixel pitch	<ul style="list-style-type: none"> 4K UHD - 163 FHD - 0.3114 mm x 0.3114 mm 4K UHD - 0.1554 mm x 0.1554 mm
Color depth	<ul style="list-style-type: none"> FHD - 16.7 M 4K UHD - 1.07 B
Contrast ratio (min)	<ul style="list-style-type: none"> FHD - 600 4K UHD - 910
Contrast ratio (typical)	<ul style="list-style-type: none"> FHD - 1000 4K UHD - 1350
Response time (max)	25 min-sec
Refresh rate	60 Hhz
Horizontal viewing angle	178 degrees
Vertical viewing angle	178 degrees

Power

Table 12. Power

Power Supply Wattage	240W EPA Platinum
AC input Voltage Range	90 – 264 Vac
AC input current (low AC range/high AC range)	3.6A/1.8A
AC input Frequency	47HZ - 63HZ
AC holdup time (80% load)	16 mini sec
Average Efficiency	90-92-89% @ 20-50-100% load
Typical Efficiency (Active PFC)	N/A
DC parameters	
+12.0 v output	NA
+19.5 v output	19.5VA - 8.5A and 19.5VB - 10.5A
+19.5 v output auxiliary output	19.5VA - 0.5A and 19.5VB - 1.75A Standby mode 19.5VA - 0.5A and 19.5VB - 1.75a
Max total power	240 W
Max combined 12.0 v power (note: only if more than one 12 v rail)	N/A
BTUs/h (based on PSU max wattage)	819 BTU
Power Supply Fan	N/A
Compliance	
Erp Lot6 Tier 2 0.5watt requirement	Yes

Climate Savers / 80Plus Compliant	Yes
Energy Star 6.1 Qualified	Yes
FEMP Standby Power Compliant	Yes

Table 13. Thermal Dissipation

Power	Graphics	Heat dissipation	Voltage
240W	Discrete gfx	240 * 3.4125 = 819 BTU/hr	100 to 240 VAC , 50 to 60 Hz , 3.6A/1.8 A

Table 14. CMOS battery

3.0v CMOS battery (Type and estimated battery life)

Brand	Type	Voltage	Composition	Life
VIC-DAWN	CR-2032	3V	Lithium	Continuous Discharge Under 30 kΩ Load till 2.0V End-Voltage at the temperature of 23°C ±3°C. The batteries should be submitted to 150 temperature cycles from 60°C~-10°C, and then be stored for more than 24hours at 23°C ±3°C
JHIH HONG	CR-2032	3V	Lithium	Continuous Discharge Under 15 kΩ Load to 2.5V End-Voltage. 20°C±2°C: 940Hrs or longer; 910Hrs or longer after 12 months.
mitsubishi	CR-2032	3V	Lithium	Continuous Discharge Under 15 kΩ Load to 2.0V End-Voltage. 20°C±2°C: 1000Hrs or longer; 970Hrs or longer after 12 months. 0°C±2°C: 910Hrs or longer; 890Hrs or longer after 12 months.

Physical system dimensions

NOTE: System weight and shipping weight is based on a typical configuration and may vary based on PC configuration. A typical configuration includes: integrated graphics and one hard drive.

Table 15. System dimensions

Non-touch chassis weight without stand (pounds / kilograms)	18.54 / 8.41
Touch chassis weight without stand (pounds / kilograms)	19.03 / 8.63
Non-touch chassis dimensions (system without stand):	
Height (inches / centimeters)	15.31 / 38.90
Width (inches / centimeters)	24.17 / 61.40
Depth (inches / centimeters)	<ul style="list-style-type: none">• 2.28 / 5.80 (UHD)• 2.27 / 5.77 (FHD)
Touch chassis dimensions (system without stand):	
Height (inches / centimeters)	15.31 / 38.9
Width (inches / centimeters)	24.17 / 61.4
Depth (inches / centimeters)	<ul style="list-style-type: none">• 2.28 / 5.8 (UHD)• 2.27 / 5.77 (FHD)
Height adjustable stand dimensions	
Width x Depth (inches / centimeters)	11.30 x 10.03 / 28.70 x 25.48
Weight (pounds / kilograms)	7.10 / 3.22
Articulating stand dimensions	
Width x Depth (inches / centimeters)	10.69 x 10.68 / 27.15 x 27.13
Weight (pounds / kilograms)	9.79 / 4.44
Packaging parameters with height adjustable stand	
Height (inches / centimeters)	21.57 / 54.80
Width (inches / centimeters)	36.14 / 91.80
Depth (inches / centimeters)	8.50 / 21.60
Shipping weight (pounds / kilograms - includes packaging materials)	35.27 / 16.0
Packaging parameters with articulating stand	
Height (inches / centimeters)	21.77 x 55.30
Width (inches / centimeters)	28.50 / 72.40
Depth (inches / centimeters)	10.20 / 25.90
Shipping weight (pounds / kilograms - includes packaging materials)	37.48 / 17.00

Environmental

NOTE: For more details on Dell Environmental features, please to go to Environmental Attributes section. See your specific region for availability.

Table 16. Environmental

Recyclable packaging	Yes
BFR/PVC—free chassis	No
Vertical orientation packaging support	Yes
MultiPack packaging	Select countries
	No
Energy Efficient Power Supply	Yes

System setup

System setup enables you to manage your desktop hardware and specify BIOS level options. From the System setup, you can:

- Change the NVRAM settings after you add or remove hardware
- View the system hardware configuration
- Enable or disable integrated devices
- Set performance and power management thresholds
- Manage your computer security

Topics:

- [BIOS overview](#)
- [Navigation keys](#)
- [Boot Sequence](#)
- [Entering BIOS setup program](#)
- [General screen options](#)
- [System configuration screen options](#)
- [Security screen options](#)
- [Secure boot screen options](#)
- [Intel Software Guard Extensions screen options](#)
- [Performance screen options](#)
- [Power Management screen options](#)
- [POST Behavior screen options](#)
- [Manageability](#)
- [Virtualization support screen options](#)
- [Wireless screen options](#)
- [Maintenance screen options](#)
- [System Log screen options](#)
- [Advanced configuration options](#)
- [System and setup password](#)

BIOS overview

⚠ CAUTION: Unless you are an expert computer user, do not change the settings in the BIOS Setup program. Certain changes can make your computer work incorrectly.

ℹ NOTE: Before you change BIOS Setup program, it is recommended that you write down the BIOS Setup program screen information for future reference.

Use the BIOS Setup program for the following purposes:

- Get information about the hardware installed in your computer, such as the amount of RAM and the size of the hard drive.
- Change the system configuration information.
- Set or change a user-selectable option, such as the user password, type of hard drive installed, and enabling or disabling base devices.

Navigation keys

NOTE: For most of the System Setup options, changes that you make are recorded but do not take effect until you restart the system.

Keys	Navigation
Up arrow	Moves to the previous field.
Down arrow	Moves to the next field.
Enter	Selects a value in the selected field (if applicable) or follow the link in the field.
Spacebar	Expands or collapses a drop-down list, if applicable.
Tab	Moves to the next focus area.

NOTE: For the standard graphics browser only.

Esc Moves to the previous page until you view the main screen. Pressing Esc in the main screen displays a message that prompts you to save any unsaved changes and restarts the system.

Boot Sequence

Boot Sequence allows you to bypass the System Setup–defined boot device order and boot directly to a specific device (for example: optical drive or hard drive). During the Power-on Self Test (POST), when the Dell logo appears, you can:

- Access System Setup by pressing F2 key
- Bring up the one-time boot menu by pressing F12 key

The one-time boot menu displays the devices that you can boot from including the diagnostic option. The boot menu options are:

- Removable Drive (if available)
- STXXXX Drive

NOTE: XXX denotes the SATA drive number.

- Optical Drive (if available)
- SATA Hard Drive (if available)
- Diagnostics

NOTE: Choosing Diagnostics, will display the ePSA diagnostics screen.

The boot sequence screen also displays the option to access the System Setup screen.

Entering BIOS setup program

- 1 Turn on (or restart) your computer.
- 2 During POST, when the DELL logo is displayed, watch for the F2 prompt to appear, and then press F2 immediately.

NOTE: The F2 prompt indicates that the keyboard is initialized. This prompt can appear very quickly, so you must watch for it, and then press F2. If you press F2 before the F2 prompt, this keystroke is lost. If you wait too long and the operating system logo appears, continue to wait until you see the desktop. Then, turn off your computer and try again.

General screen options

This section lists the primary hardware features of your computer.

Option	Description
System Information	<ul style="list-style-type: none">• System Information: Displays BIOS Version, Service Tag, Asset Tag, Ownership Tag, Ownership Date, Manufacture Date, and the Express Service Code.• Memory Information: Displays Memory Installed, Memory Available, Memory Speed, Memory Channels Mode, Memory Technology, DIMM A Size, DIMM B Size.• PCI information: Displays SLOT 1 and SLOT 2• Processor Information: Displays Processor Type, Core Count, Processor ID, Current Clock Speed, Minimum Clock Speed, Maximum Clock Speed, Processor L2 Cache, Processor L3 Cache, HT Capable, and 64-Bit technology.• Device Information: Displays SATA-0, SATA-1, LOM MAC Address, Video Controller, dGPU Video Controller, Audio Controller, Wi Fi Device, and Bluetooth Device.

Boot Sequence

Boot Sequence	Allows you to specify the order in which the computer attempts to find an operating system. To change the boot order, select the device that you want to change in the list, which is available on the right-hand side. After you select the device, click up or down arrows or use your keyboard Page Up or Page Down keys to change the boot options order. You can also select or de-select from the list using the check-boxes available on the left hand side. You should enable the Legacy Option ROMs to setup the Legacy boot mode. This Legacy boot mode is not allowed when you enable the Secure Boot. The options are:
----------------------	--

- Boot Sequence - By default, the Windows Boot Manager check box is selected.



NOTE: The default option might differ based on the operating system of your computer.

- Boot List Option - The list options are Legacy and UEFI. By default, the option UEFI is selected.



NOTE: The default option might differ based on the operating system of your computer.

- Add Boot Option - Enables you to add a boot option.
- Delete Boot Option - Enables you to delete an existing boot option.
- View - Enables you to view the current boot option in the computer.
- Restore Settings - Restores the default settings of the computer.
- Save Settings - Saves the settings of the computer.
- Apply - Enables you to apply the settings.
- Exit - Exits and starts the computer.

Boot List Options	Allows you to change the boot list option:
--------------------------	--

- Legacy
- UEFI (enabled by default)

UEFI Boot Path Security

The option controls whether or not the system prompts the user to enter the Admin password (if set) when booting a UEFI boot path from the F12 Boot Menu.

- Always, Except Internal HDD
- Always



Option	Description
	<ul style="list-style-type: none"> · Never
Advanced Boot Options	<p>This option allows you the legacy option ROMs to load. By default, the Enable Legacy Option ROMs is disabled.</p> <ul style="list-style-type: none"> · Restore Settings - Restores the default settings of the computer · Save Settings - Saves the settings of the computer · Apply - Enables you to apply the settings · Exit - Exits and starts the computer
Date/Time	Allows you to change the date and time.

System configuration screen options

Option	Description
Integrated NIC	<p>If you enable UEFI network stack, UEFI network protocols will be available. UEFI network allows pre-os and early os networking features to use NICs that are enabled. This may be used without PXE turned on. When you enable Enabled w/PXE, the type of PXE boot (Legacy PXE or UEFI PXE) depends on the current boot mode and type of option ROMs in use. The UEFI Network Stack is required in order to have UEFI PXE functionality fully enabled.</p> <ul style="list-style-type: none"> · Enabled UEFI Network Stack - This option is disabled by default. <p>Allows you to configure the integrated network controller. The options are:</p> <ul style="list-style-type: none"> · Disabled · Enabled · Enabled w/PXE: This option is enabled by default. · Enabled w/Cloud Desktop <p>i NOTE: Depending on the computer and its installed devices, the items listed in this section may or may not appear.</p>
SATA Operation	<p>Allows you to configure the internal SATA hard-drive controller. The options are:</p> <ul style="list-style-type: none"> · Disabled · AHCI · RAID On: This option is enabled by default.
Drives	<p>Allows you to configure the SATA drives on board. All drives are enabled by default. The options are:</p> <ul style="list-style-type: none"> · SATA-0 · SATA-1 · SATA-4 · M.2 PCIe SSD-0
SMART Reporting	<p>This field controls whether hard drive errors for integrated drives are reported during system startup. This technology is part of the SMART (Self Monitoring Analysis and Reporting Technology) specification. This option is disabled by default.</p> <ul style="list-style-type: none"> · Enable SMART Reporting
USB Configuration	<p>This field configures the integrated USB controller. If Boot Support is enabled, the system is allowed to boot any type of USB Mass Storage Devices (HDD, memory key, floppy).</p>

Option	Description
	<p>If USB port is enabled, device attached to this port is enabled and available for OS.</p> <p>If USB port is disabled, the OS cannot see any device attached to this port.</p> <p>The options are:</p> <ul style="list-style-type: none"> · Enable USB Boot Support · Enable Rear USB Ports: Include options for 6 ports · Enable Side USB Ports: Include options for 2 ports <p>All the options are enabled by default.</p> <p> NOTE: USB keyboard and mouse always work in the BIOS setup irrespective of these settings.</p>
Rear USB Configuration	<p>This field allows you to enable or disable rear USB ports.</p> <ul style="list-style-type: none"> · Enable/Disable Rear USB Ports
Side USB Configuration	<p>This field allows you to enable or disable side USB ports.</p> <ul style="list-style-type: none"> · Enable/Disable Side USB Ports
USB PowerShare	<p>This field configures the USB PowerShare feature behavior. This option allows you to charge external devices using the stored system battery power through the USB PowerShare port.</p>
Audio	<p>This field enables or disables the integrated audio controller. By default, the Enable Audio option is selected. The options are:</p> <ul style="list-style-type: none"> · Enable Microphone (by default enable) · Enable Internal Speaker (by default enable)
OSD Button Management	<p>This field allows you to enable or disable the OSD (On-Screen Display) buttons on the All-In-One system.</p> <ul style="list-style-type: none"> · Disable OSD buttons: This option is unchecked by default.
Touchscreen	<p>This option allows you to enable or disable touchscreen.</p>
Miscellaneous Devices	<p>Allows you to enable or disable the following devices:</p> <ul style="list-style-type: none"> · Enable Camera (enabled by default) · Enable Media Card (enabled by default) · Disable Media Card

Security screen options

Option	Description
Admin Password	<p>Allows you to set, change, or delete the administrator (admin) password.</p> <p> NOTE: You must set the admin password before you set the system or hard drive password. Deleting the admin password automatically deletes the system password and the hard drive password.</p> <p> NOTE: Successful password changes take effect immediately.</p> <p>Default setting: Not set</p>
System Password	<p>Allows you to set, change or delete the system password.</p>

Option	Description
Internal HDD-0 Password	<p data-bbox="339 149 1027 174">NOTE: Successful password changes take effect immediately.</p> <p data-bbox="331 205 568 226">Default setting: Not set</p>
Strong Password	<p data-bbox="331 443 983 468">Allows you to enforce the option to always set strong passwords.</p> <p data-bbox="331 485 898 506">Default Setting: Enable Strong Password is not selected.</p> <p data-bbox="339 537 1481 600">NOTE: If Strong Password is enabled, Admin and System passwords must contain at least one uppercase character, one lowercase character and be at least 8 characters long.</p>
Password Configuration	Allows you to determine the minimum and maximum length of Administrator and System passwords.
Password Bypass	<p data-bbox="331 716 1457 772">Allows you to enable or disable the permission to bypass the System and the Internal HDD password, when they are set. The options are:</p> <ul data-bbox="339 804 520 863" style="list-style-type: none"> <li data-bbox="339 804 456 825">· Disabled <li data-bbox="339 842 520 863">· Reboot bypass <p data-bbox="331 894 576 915">Default setting: Disabled</p>
Password Change	<p data-bbox="331 968 1477 1024">Allows you to enable the disable permission to the System and Hard Drive passwords when the admin password is set.</p> <p data-bbox="331 1041 999 1062">Default setting: Allow Non-Admin Password Changes is selected.</p>
UEFI Capsule firmware Updates	<p data-bbox="331 1115 1222 1136">This option controls if the system allows BIOS updates via UEFI capsule update package.</p> <ul data-bbox="339 1167 1062 1188" style="list-style-type: none"> <li data-bbox="339 1167 1062 1188">· Default setting: Enable UEFI Capsule Firmware Updates is selected.
TPM 2.0 Security	<p data-bbox="331 1230 1430 1287">Allows you to enable the Trusted Platform Module (TPM) during POST. This option is enabled by default. The options are:</p> <ul data-bbox="339 1318 727 1608" style="list-style-type: none"> <li data-bbox="339 1318 552 1339">· TPM On (Default) <li data-bbox="339 1356 424 1377">· Clear <li data-bbox="339 1394 727 1415">· PPI Bypass for Enabled Commands <li data-bbox="339 1432 727 1453">· PPI Bypass for Disabled Commands <li data-bbox="339 1470 695 1491">· PPI Bypass for Clear Commands <li data-bbox="339 1507 647 1528">· Attestation Enable (Default) <li data-bbox="339 1545 663 1566">· Key Storage Enable (Default) <li data-bbox="339 1583 568 1604">· SHA - 256 (Default) <p data-bbox="339 1629 1481 1692">NOTE: Activation, deactivation, and clear options are not affected if you load the setup program's default values. Changes to this option take effect immediately.</p>
Computrace (R)	<p data-bbox="331 1724 1174 1749">Allows you to activate or disable the optional Computrace software The options are:</p> <ul data-bbox="339 1780 472 1881" style="list-style-type: none"> <li data-bbox="339 1780 472 1801">· Deactivate <li data-bbox="339 1818 440 1839">· Disable <li data-bbox="339 1856 456 1877">· Activate

Option	Description
	<p> NOTE: The Activate and Disable options will permanently activate or disable the feature and no further changes will be allowed</p> <p>Default setting: Deactivate</p>
Chassis Intrusion	<p>This field controls the chassis intrusion feature. The options are:</p> <ul style="list-style-type: none"> · Disabled · Enabled <p>Default setting: Disabled</p>
OROM Keyboard Access	<p>Allows you to set an option to enter the Option ROM Configuration screens using hotkeys during boot. The options are:</p> <ul style="list-style-type: none"> · Enabled · One Time Enable · Disabled <p>Default setting: Enable</p>
Admin Setup Lockout	<p>Allows you to enable or disable the option to enter setup when an admin password is set.</p> <ul style="list-style-type: none"> · Enable Admin Setup Lockout - This option is disabled by default.
Master Password Lockout	<p>When enabled this option will disable master password support. Hard Disk passwords need to be cleared before the setting can be changed.</p> <ul style="list-style-type: none"> · Enable Master Password Lockout
SMM Security Mitigation	<p>This option enables or disables additional UEFI SMM Security Mitigation protections.</p> <ul style="list-style-type: none"> · SMM Security Mitigation

Secure boot screen options

Option	Description
Secure Boot Enable	<p>This option enables or disables the Secure Boot feature.</p> <ul style="list-style-type: none"> · Disabled · Enabled <p>Default setting: Enabled.</p>
Secure Boot Mode	<p>Changes to the Secure Boot operation mode and modifies the behavior of Secure Boot to allow evaluation or enforcement of UEFI driver signatures.</p> <ul style="list-style-type: none"> · Deployed Mode- This option is enabled by default · Audit mode
Expert Key Management	<p>Allows you to manipulate the security key databases only if the system is in Custom Mode. The Enable Custom Mode option is disabled by default. The options are:</p> <ul style="list-style-type: none"> · PK

Option	Description
--------	-------------

- KEK
- db
- dbx

If you enable the **Custom Mode**, the relevant options for **PK, KEK, db, and dbx** appear. The options are:

- **Save to File**—Saves the key to a user-selected file
- **Replace from File**—Replaces the current key with a key from a user-selected file
- **Append from File**—Adds a key to the current database from a user-selected file
- **Delete**—Deletes the selected key
- **Reset All Keys**—Resets to default setting
- **Delete All Keys**—Deletes all the keys

 **NOTE:** If you disable the **Custom Mode**, all the changes made will be erased and the keys will restore to default settings.

Intel Software Guard Extensions screen options

Option	Description
--------	-------------

Intel SGX Enable This field specifies you to provide a secured environment for running code/storing sensitive information in the context of the main OS. The options are:

- Disabled
- Enabled
- **Software Controlled** (default)

Enclave Memory Size This option sets **SGX Enclave Reserve Memory Size**. The options are:

- 32 MB
- 64 MB
- 128 MB

Performance screen options

Option	Description
--------	-------------

Multi Core Support Specifies whether the process will have one or all cores enabled. The performance of some applications will improve with the additional cores.

- All - This option is enabled by default
- 1
- 2
- 3

Intel SpeedStep Allows you to enable or disable the Intel SpeedStep feature.

- Enable Intel SpeedStep

Default setting: The option is enabled.

C-States Control Allows you to enable or disable the additional processor sleep states.

Option **Description**

- C states

Default setting: The option is enabled.

Intel TurboBoost Allows you to enable or disable the Intel TurboBoost mode of the processor.

- Enable Intel TurboBoost

Default setting: The option is enabled.

Power Management screen options

Option **Description**

AC Recovery Allows you to enable or disable the computer from turning on automatically when an AC adapter is connected.

- Power Off (default)
- Power On
- Last Power State

Enable Intel Speed Shift Technology This option is used to enable or disable the Intel speed shift technology support. The option is enabled by default.

Auto On Time Allows you to set the time at which the computer must turn on automatically. The options are:

- Disabled
- Every Day
- Weekdays
- Select Days

Default setting: Disabled

Deep Sleep Control Allows you to aggressive the system is at conserving power while Shut down (S5) or in Hibernate (S4) mode.

- Disabled (default)
- Enabled in S5 only
- Enabled in S4 and S5

Fan Control Override Controls the speed of the system fan. This option is disabled by default.

 **NOTE: When enabled, the fan runs at full speed.**

USB Wake Support Allows you to enable USB devices to wake the system from Standby.

 **NOTE: This feature is only functional when the AC power adapter is connected. If the AC power adapter is removed during Standby, the system setup removes power from all the USB ports to conserve battery power.**

- Enable USB Wake Support

Default setting: The option is enabled..

Wake on LAN/WLAN Allows you to enable or disable the feature that powers on the computer from the Off state when triggered by a LAN signal.

- **Disabled:** This option is enabled by default.

Option	Description
	<ul style="list-style-type: none"> · LAN Only · WLAN Only · LAN or WLAN · LAN with PXE Boot
Block Sleep	<p>This option lets you block entering to sleep (S3 state) in operating system environment.</p> <p>Block Sleep (S3 state)</p> <p>Default setting: This option is disabled</p>

POST Behavior screen options

Option	Description
Numlock LED	<p>This option option specifies whether the NumLock LED should be on when the system boots.</p> <ul style="list-style-type: none"> · Enable Numlock LED: The option is enabled.
Keyboard Errors	<p>This option option specifies whether the keyboard related errors are reported when it boots.</p> <ul style="list-style-type: none"> · Enables Keyboard Error Detection: The option is enabled by default.
Fastboot	<p>Allows you to speed up the boot process by bypassing some of the compatibility steps. The options are:</p> <ul style="list-style-type: none"> · Minimal · Thorough (default) · Auto
Extend BIOS POST Time	<p>This option created an additional pre-boot delay.</p> <ul style="list-style-type: none"> · 0 seconds (default) · 5 seconds · 10 seconds
Full Screen Logo	<p>. This option displays full screen logo if your image match screen resolution. The option Enable Full Screen Logo is not selected by default.</p>
Warnings and Errors	<ul style="list-style-type: none"> · Prompt on Warnings and Errors (default) · Continue on Warnings · Continue on Warnings and Errors

Manageability

Option	Description
USB Provision	<p>When enabled Intel AMT can be provisioned using the local provisioning file via a USB storage device.</p> <ul style="list-style-type: none"> · Enable USB Provision
MEBx Hotkey	<p>This option specifies whether the MEBx Hotkey function should be enabled when the system boots.</p>

Option	Description
	Enable MEBx Hotkey - enabled by default.

Virtualization support screen options

Option	Description
Virtualization	Allows you to enable or disable the Intel Virtualization Technology. Enable Intel Virtualization Technology (default).
VT for Direct I/O	Enables or disables the Virtual Machine Monitor (VMM) from utilizing the additional hardware capabilities provided by Intel® Virtualization technology for direct I/O. Enable VT for Direct I/O - enabled by default.
Trusted Execution	This option specifies whether a Measured Virtual Machine Monitor (MVMM) can utilize the additional hardware capabilities provided by Intel Trusted Execution Technology, the TPM Virtualization Technology, and Virtualization technology for direct I/O must be enabled to use this feature. Trusted Execution - disabled by default.

Wireless screen options

Option	Description
Wireless Device Enable	Allows you to enable or disable the internal wireless devices. <ul style="list-style-type: none"> · WLAN/WiGig · Bluetooth All the options are enabled by default.

Maintenance screen options

Option	Description
Service Tag	Displays the Service Tag of your computer.
Asset Tag	Allows you to create a system asset tag if an asset tag is not already set. This option is not set by default.
SERR Messages	This field controls the SERR message mechanism. Some graphic card required the SERR message. <ul style="list-style-type: none"> · Enable SERR Messages (default)
BIOS Downgrade	This field controls flashing of the system firmware to previous revisions. Allows BIOS Downgrade (Enabled by default)
Data Wipe	This field enables user to erase data from all internal storage device.
BIOS Recovery	Allows you to recover from certain corrupted BIOS conditions from a recover file on the user primary hard drive or an external USB key. Enabled by default.
First Power On Date	This option lets you set Ownership date. This option is disabled by default.

System Log screen options

Option	Description
BIOS Events	Allows you to view and clear the System Setup (BIOS) POST events.

Advanced configuration options

Option	Description
ASPM	Allows you to set the ASPM level. <ul style="list-style-type: none">· Auto (default)· Disabled· L1 Only

System and setup password

Table 17. System and setup password

Password type	Description
System password	Password that you must enter to log on to your system.
Setup password	Password that you must enter to access and make changes to the BIOS settings of your computer.

You can create a system password and a setup password to secure your computer.

 **CAUTION:** The password features provide a basic level of security for the data on your computer.

 **CAUTION:** Anyone can access the data stored on your computer if it is not locked and left unattended.

 **NOTE:** System and setup password feature is disabled.

Assigning a system password and setup password

You can assign a new **System Password** only when the status is in **Not Set**.

To enter the system setup, press F2 immediately after a power-on or re-boot.

- 1 In the **System BIOS** or **System Setup** screen, select **Security** and press Enter.
The **Security** screen is displayed.
- 2 Select **System Password** and create a password in the **Enter the new password** field.
Use the following guidelines to assign the system password:
 - A password can have up to 32 characters.
 - The password can contain the numbers 0 through 9.
 - Only lower case letters are valid, upper case letters are not allowed.
 - Only the following special characters are allowed: space, ("), (+), (,), (-), (.), (/), (:), ([), (\), (]), (`).
- 3 Type the system password that you entered earlier in the **Confirm new password** field and click **OK**.
- 4 Press Esc and a message prompts you to save the changes.
- 5 Press Y to save the changes.

The computer reboots.

Deleting or changing an existing system setup password

Ensure that the **Password Status** is Unlocked (in the System Setup) before attempting to delete or change the existing System and/or Setup password. You cannot delete or change an existing System or Setup password, if the **Password Status** is Locked. To enter the System Setup, press F2 immediately after a power-on or reboot.

- 1 In the **System BIOS** or **System Setup** screen, select **System Security** and press Enter.
The **System Security** screen is displayed.
- 2 In the **System Security** screen, verify that **Password Status** is **Unlocked**.
- 3 Select **System Password**, alter or delete the existing system password and press Enter or Tab.
- 4 Select **Setup Password**, alter or delete the existing setup password and press Enter or Tab.

 **NOTE: If you change the System and/or Setup password, re-enter the new password when promoted. If you delete the System and/or Setup password, confirm the deletion when promoted.**

- 5 Press Esc and a message prompts you to save the changes.
- 6 Press Y to save the changes and exit from System Setup.
The computer reboot.

Software

This chapter details the supported operating systems along with instructions on how to install the drivers.

Topics:

- Supported operating systems
- Downloading drivers
- Intel chipset drivers
- Display adapter drivers
- Audio drivers
- Network drivers
- Camera drivers
- Storage drivers
- Security drivers
- Bluetooth drivers
- USB drivers

Supported operating systems

Table 18. Supported operating systems

Supported operating systems	Description
Windows 10	<ul style="list-style-type: none"> · Windows 10 Home (64 bit) · Windows 10 Professional (64 bit) · Windows 10 Home National Academic · Windows 10 Pro National Academic
Others	<ul style="list-style-type: none"> · Ubuntu 16.04 SP1 LTS (64bit)

Downloading drivers

- 1 Turn on the desktop.
- 2 Go to **Dell.com/support**.
- 3 Click **Product Support**, enter the Service Tag of your desktop, and then click **Submit**.

 **NOTE: If you do not have the Service Tag, use the auto detect feature or manually browse for your desktop model.**

- 4 Click **Drivers and Downloads**.
- 5 Select the operating system installed on your desktop.
- 6 Scroll down the page and select the driver to install.
- 7 Click **Download File** to download the driver for your desktop.
- 8 After the download is complete, navigate to the folder where you saved the driver file.
- 9 Double-click the driver file icon and follow the instructions on the screen.



Intel chipset drivers

Verify if the Intel chipset drivers are already installed in the system.

- System devices
 - ACPI Fan
 - ACPI Fan
 - ACPI Fan
 - ACPI Fan
 - ACPI Fan
 - ACPI Fixed Feature Button
 - ACPI Power Button
 - ACPI Processor Aggregator
 - ACPI Thermal Zone
 - Composite Bus Enumerator
 - Dell Diag Control Device
 - Dell System Analyzer Control Device
 - High Definition Audio Controller
 - High precision event timer
 - Intel(R) 300 Series Chipset Family LPC Controller (Q370) - A306
 - Intel(R) Gaussian Mixture Model - 1911
 - Intel(R) Host Bridge/DRAM Registers - 3EC2
 - Intel(R) Management Engine Interface
 - Intel(R) PCI Express Root Port #6 - A33D
 - Intel(R) PCI Express Root Port #8 - A33F
 - Intel(R) PCIe Controller (x16) - 1901
 - Intel(R) Power Engine Plug-in
 - Intel(R) SMBus - A323
 - Intel(R) SPI (flash) Controller - A324
 - Intel(R) Thermal Subsystem - A379
 - Microsoft ACPI-Compliant System
 - Microsoft System Management BIOS Driver
 - Microsoft UEFI-Compliant System
 - Microsoft Virtual Drive Enumerator
 - Microsoft Windows Management Interface for ACPI
 - Microsoft Windows Management Interface for ACPI
 - Microsoft Windows Management Interface for ACPI
 - Microsoft Windows Management Interface for ACPI
 - Microsoft Windows Management Interface for ACPI
 - Microsoft Windows Management Interface for ACPI
 - Microsoft Windows Management Interface for ACPI
 - NDIS Virtual Network Adapter Enumerator
 - Numeric data processor
 - PCI Express Root Complex
 - PCI standard RAM Controller
 - Plug and Play Software Device Enumerator
 - Programmable interrupt controller
 - Remote Desktop Device Redirector Bus
 - System CMOS/real time clock
 - System timer
 - UMBus Root Bus Enumerator







Display adapter drivers

Verify if the drivers for the display adapter is already installed in the system.

- ▼  Display adapters
 -  Intel(R) UHD Graphics 630
 -  NVIDIA GeForce GTX 1050













Audio drivers

Verify if the audio drivers are already installed in the system.

- ▼  Audio inputs and outputs
 -  Microphone Array (Realtek(R) Audio)
 -  Speakers/Headphones (Realtek(R) Audio)
- ▼  Sound, video and game controllers
 -  Intel(R) Display Audio
 -  Realtek(R) Audio



Network drivers

Verify if network drivers are already installed in the system.

- ▼  Network adapters
 -  Bluetooth Device (Personal Area Network)
 -  Bluetooth Device (RFCOMM Protocol TDI)
 -  Intel(R) Ethernet Connection (7) I219-LM #2
 -  Qualcomm QCA61x4A 802.11ac Wireless Adapter
 -  WAN Miniport (IKEv2)
 -  WAN Miniport (IP)
 -  WAN Miniport (IPv6)
 -  WAN Miniport (L2TP)
 -  WAN Miniport (Network Monitor)
 -  WAN Miniport (PPPOE)
 -  WAN Miniport (PPTP)
 -  WAN Miniport (SSTP)



Camera drivers

Verify if the camera driver is already installed in the system.



- ▼  Cameras
 -  Integrated Webcam
 -  Integrated Webcam

Storage drivers

Verify if the storage controller drivers are already installed in the system.



- ▼  Storage controllers
 -  Intel(R) Chipset SATA/PCIe RST Premium Controller
 -  Microsoft Storage Spaces Controller

Verify if the storage drivers are already installed in the system.

- ▼  Disk drives
 -  ST500LX025-1U717D





Security drivers

Verify if the security drivers are already installed in the system.

- ▼  Security devices
 -  Trusted Platform Module 2.0





Bluetooth drivers

Verify if the Bluetooth drivers are already installed in the system.

- ▼  Bluetooth
 -  Microsoft Bluetooth Enumerator
 -  Microsoft Bluetooth LE Enumerator
 -  Microsoft Bluetooth Protocol Support Driver
 -  Qualcomm QCA61x4A Bluetooth 4.1

USB drivers

Verify if the USB drivers are already installed in the system.

- ▼  Universal Serial Bus controllers
 -  Intel(R) USB 3.1 eXtensible Host Controller - 1.10 (Microsoft)
 -  USB Composite Device
 -  USB Composite Device
 -  USB Root Hub (USB 3.0)

Getting help

Contacting Dell

NOTE: If you do not have an active Internet connection, you can find contact information on your purchase invoice, packing slip, bill, or Dell product catalog.

Dell provides several online and telephone-based support and service options. Availability varies by country and product, and some services may not be available in your area. To contact Dell for sales, technical support, or customer service issues:

- 1 Go to **Dell.com/support**.
- 2 Select your support category.
- 3 Verify your country or region in the **Choose a Country/Region** drop-down list at the bottom of the page.
- 4 Select the appropriate service or support link based on your need.