



OWNER'S MANUAL

LG UltraGear™

Gaming Monitor

(LED Monitor*)

* LG LED Monitor applies LCD screen with LED backlights.

Please read this manual carefully before operating your set and retain it for future reference.

38GL950G

www.lg.com

Copyright © 2019 LG Electronics Inc. All Rights Reserved.

TABLE OF CONTENTS

LICENSE.....3

OPEN SOURCE SOFTWARE NOTICE INFORMATION4

ASSEMBLING AND PREPARING 4

- Supported Drivers and Software 5
 - Monitor Driver
 - OnScreen Control
 - LG UltraGear™ Control Center
- Product and Button Description..... 5
 - How to Use the Joystick Button
 - How to Use the Lighting Button
- Moving and Lifting the Monitor..... 7
 - Installing on a Table
 - Adjusting the Stand Height
 - Adjusting the Angle
 - Tidying up Cables

- Using the Kensington Lock
- Installing the Wall Mount Plate
- Installing on the Wall

USING THE MONITOR..... 15

- Connecting to a PC..... 15
 - HDMI Connection
 - DisplayPort Connection
- Connecting AV Devices..... 16
 - HDMI Connection
- Connecting Peripherals..... 17
 - USB Device connection
 - Connecting Headphones
- Service only port 17

USER SETTINGS 18

- Activating the Main Menu 18
 - Main Menu Features
 - Menu Settings
 - Game Mode (for SDR only)

- Game Adjust
- Picture Adjust
- Input
- General

TROUBLESHOOTING 27

PRODUCT SPECIFICATION 29

- Factory Support Mode.....31
- HDMI Timing (Video).....32
- Power LED32
- HDR Monitor33
- G-SYNC Monitor33

LICENSE

Each model has different licenses. Visit www.lg.com for more information on the license.



The terms HDMI and HDMI High-Definition Multimedia Interface, and the HDMI Logo are trademarks or registered trademarks of HDMI Licensing Administrator, Inc.



The SuperSpeed USB Trident logo is a registered trademark of USB Implementers Forum, Inc.



© 2019 NVIDIA, the NVIDIA logo, and NVIDIA G-SYNC are trademarks and/or registered trademarks of NVIDIA Corporation in the U.S. and other countries.

OPEN SOURCE SOFTWARE NOTICE INFORMATION

To obtain the source code under GPL, LGPL, MPL, and other open source licenses, that is contained in this product, please visit <http://opensource.lge.com>.

In addition to the source code, all referred license terms, warranty disclaimers and copyright notices are available for download.

LG Electronics will also provide open source code to you on CD-ROM for a charge covering the cost of performing such distribution (such as the cost of media, shipping, and handling) upon email request to opensource@lge.com.

This offer is valid for a period of three years after our last shipment of this product.

This offer is valid to anyone in receipt of this information.

ASSEMBLING AND PREPARING



CAUTION

- Always use genuine LG components to ensure safety and product performance.
- The product warranty will not cover damage or injury caused by the use of unauthorized components.
- It is recommended that use the supplied components.
- If you use generic cables not certified by LG, the screen may not display or there may be image noises.
- Illustrations in this document represent typical procedures, so they may look different from the actual product.
- Do not apply foreign substances (oils, lubricants, etc.) to the screw parts when assembling the product. (Doing so may damage the product.)

- Applying excessive force when tightening screws may cause damage to the monitor. Damage caused in this way will not be covered by the product warranty.
- Do not carry the monitor upside down by just holding the base. This may cause the monitor to fall off the stand and could result in personal injury.
- When lifting or moving the monitor, do not touch the monitor screen. The force applied to the monitor screen may cause damage to it.
- For wave pattern on appearance, unlike the general method of coating, it's applied to added glittering material in raw material. With no peeled-off appearance, it has good durability. Please use it with confidence because there is no problem in using the product at all.



NOTE

- The components may look different from those illustrated here.
- Without prior notice, all product information and specifications contained in this manual are subject to change to improve the performance of the product.
- To purchase optional accessories, visit an electronics store or an online shopping site, or contact the retailer from which you purchased the product.
- The power cord provided may differ depending upon the region.

Supported Drivers and Software

You can download and install the latest monitor driver and application version from the LGE website (www.lg.com).

Drivers and Software	Installation Priority
Monitor Driver	Recommended
OnScreen Control	Recommended
LG UltraGear™ Control Center	Recommended

Monitor Driver

- Usage : The monitor driver file provided by LG Monitor is used to ensure the compatibility of the LG monitor and the VGA card.

OnScreen Control

- Usage : Software provided so that the key features of your monitor can be operated in the PC environment, including split screen and the setting of picture modes for each software program.

LG UltraGear™ Control Center

- Usage : LG UltraGear™ Control Center is an application software that will help you easily control the Sphere Lighting(LED Lighting) of LG UltraGear™ monitor. You can easily apply various LED Lighting effects which will work with PC content by using the supported mode of the this software.

Product and Button Description

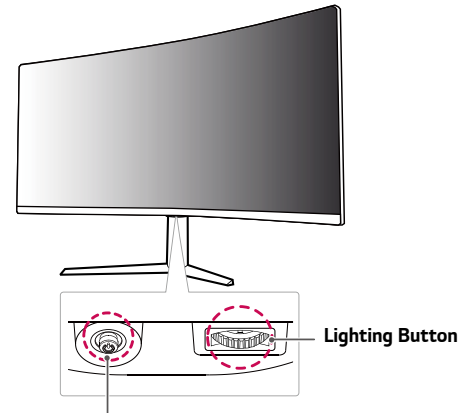

Joystick Button / Power LED



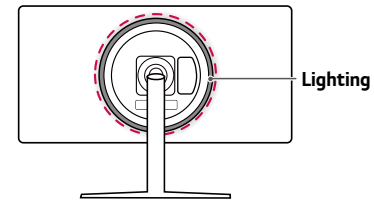



- On: Power on
- Off: Power off



How to Use the Joystick Button

You can easily control the functions of the monitor by pressing the joystick button or moving it left/right/up/down with your finger.

Basic Functions

		Power on	Press the joystick button once with your finger to turn on the monitor.
		Power off	Press and hold the joystick button once more than 10 seconds with your finger to turn off the monitor.
		Volume control	You can control the volume by moving the joystick button left/right.
		Controls screen brightness	You can control the screen's brightness by moving the joystick button up/down. (for SDR only)

How to Use the Lighting Button

You can easily control the functions of the monitor by pressing the lighting button or moving it left/right with your finger.

Basic Functions

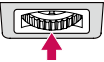
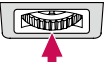
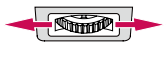
	When Lighting is Off	When Lighting is On
	Press the lighting button once with your finger to turn on the lighting on the back of the monitor.	You can adjust the color by pressing the light button.
	Press and hold the lighting button once with your finger to turn on the lighting on the back of the monitor.	Press and hold the lighting button once with your finger to turn off the lighting on the back of the monitor.
	Not functional	You can control the lighting brightness by moving the lighting button left/right.

! NOTE

- The joystick and lighting button are located at the bottom of the monitor.
- The Lighting function for the back of the monitor is available even when the monitor is in power saving mode or when its screen is off. (Settings > General > Lighting Option > Keep Lighting Status)

Moving and Lifting the Monitor

When moving or lifting the monitor, follow these instructions to prevent the monitor from being scratched or damaged and to ensure safe transportation, regardless of its shape or size.

- Place the monitor in the original box or packing material before attempting to move it.
- Before moving or lifting the monitor, disconnect the power cord and all other cables.
- Hold the bottom and side of the monitor frame firmly. Do not hold the panel itself.

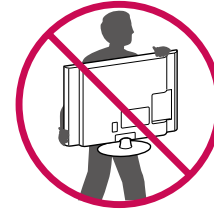
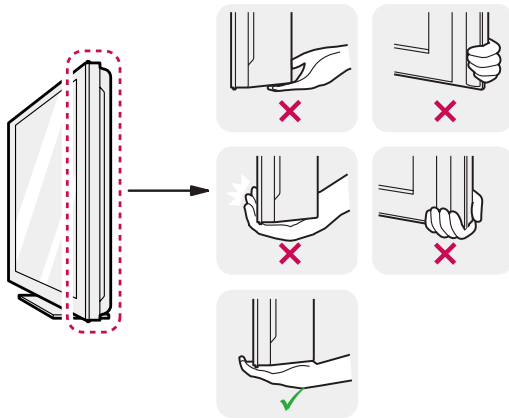

- When holding the monitor, the screen should face away from you to prevent it from being scratched.
- When transporting the monitor, do not expose the monitor to shock or excessive vibration.
- When moving the monitor, keep it upright and never turn the monitor on its side or tilt it sideways.

CAUTION

- Avoid touching the monitor screen as much as possible.
 - This may result in damage to the screen or some of the pixels used to create images.

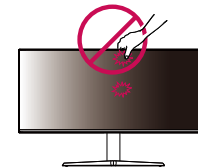

- If you use the monitor panel without the stand base, its joystick button may cause the monitor to become unstable and fall, resulting in damage to the monitor or human injury. In addition, this may cause the joystick button to malfunction.

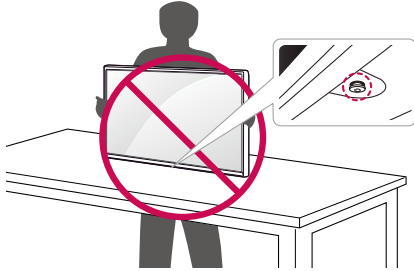

Installing on a Table

- Lift the monitor and place it on the table in an upright position. Place the monitor at least 100 mm (3.94 inches) away from the wall to ensure sufficient ventilation.

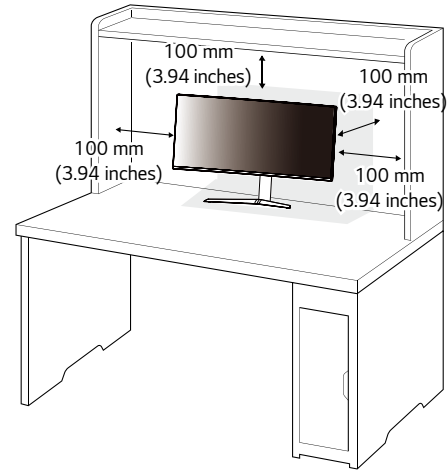

 **CAUTION**

- Unplug the power cord before moving or installing the monitor. There is risk of electric shock.
- Make sure to use the power cord that is provided in the product package and connect it to a grounded power outlet.
- If you need another power cord, please contact your local dealer or the nearest retail store.

Adjusting the Stand Height

- 1 Place the monitor mounted on the stand base in an upright position.
- 2 Handle the monitor with both hands for safety.

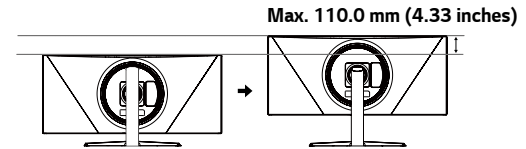
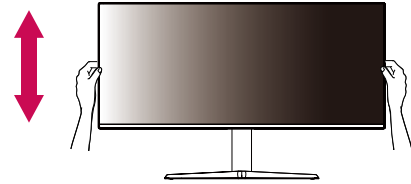
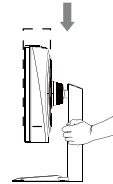
 **WARNING**

- When adjusting the screen height, do not place your hand on the stand body to avoid injury to your fingers.

Adjusting the Angle

- 1 Place the monitor mounted on the stand base in an upright position.
 - 2 Adjust the angle of the screen.
- The angle of the screen can be adjusted forward or backward from -5° to 15° for a comfortable viewing experience.

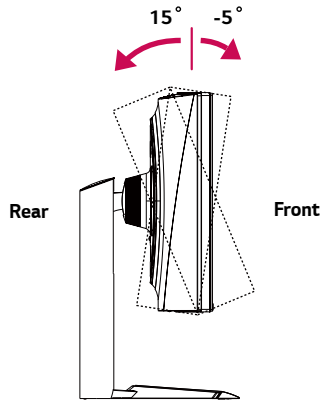

! WARNING

- To avoid injury to the fingers when adjusting the screen, do not hold the lower part of the monitor's frame as illustrated below.

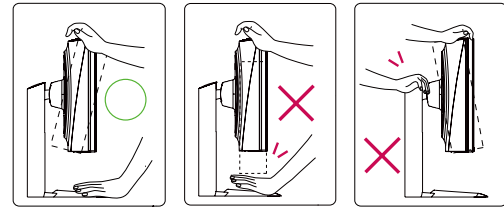

- Be careful not to touch or press the screen area when adjusting the angle of the monitor.

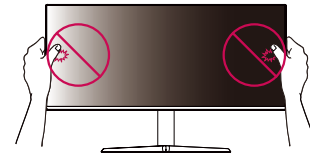

! **NOTE**

- The left or right side of the monitor head can be slightly rotated up or down (up to 3°). Adjust the horizontal level of the monitor head.

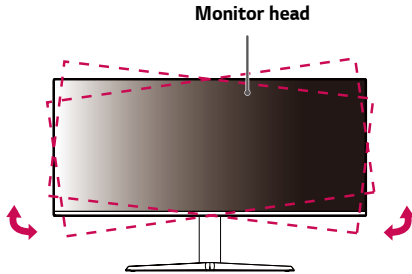
**Tidying up Cables**

Arrange the cables using the cable holder as shown in the illustration.

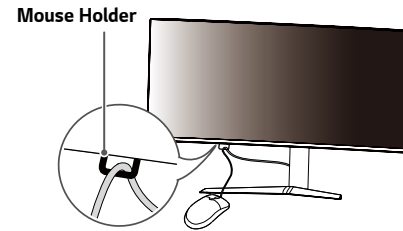

Using the Kensington Lock

The connector for the Kensington security system is located at the bottom of the monitor.

For more information on installation and usage, refer to the Kensington lock owner's manual or visit the website at <http://www.kensington.com>.

Connect the monitor to a table using the Kensington security system cable.

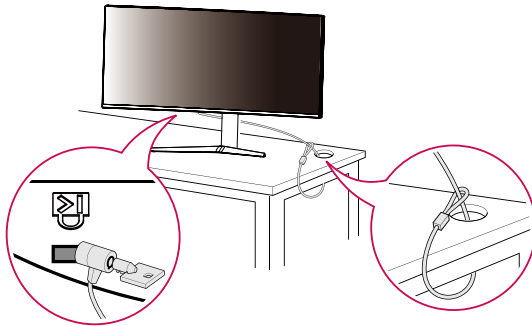

! NOTE

- The Kensington security system is optional. You can obtain optional accessories from most electronics stores.

Installing the Wall Mount Plate

This monitor meets the specifications for the wall mount plate or other compatible devices.

- 1 Place the screen face down. To protect the monitor panel (screen), cover the surface with a soft cloth or the monitor protection pad included in the product package.
- 2 Remove the four screws tightened on the back of the monitor.
- 3 Place the wall mount plate onto the monitor and align it with the screw holes.
- 4 Tighten the four screws using a screwdriver to fix the plate to the monitor.

! NOTE

- The wall mount plate is sold separately.
- For more information on installation, refer to the wall mount plate's installation guide.
- Be careful not to apply too much force while mounting the wall mount plate as it may cause damage to the screen.

Installing on the Wall

Install the monitor at least 100 mm (3.94 inches) away from the wall and leave about 100 mm (3.94 inches) of space at each side of the monitor to ensure sufficient ventilation. Detailed installation instructions can be obtained from your local retail store. Alternatively, please refer to the manual for how to install and set up a tilting wall mounting bracket.

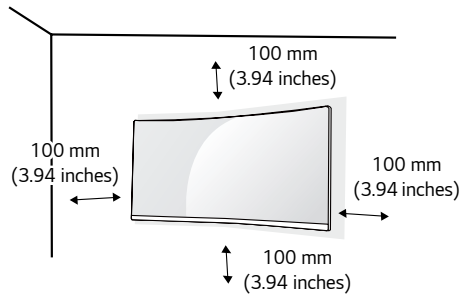

To install the monitor to a wall, attach a wall mounting bracket (optional) to the back of the monitor.

Make sure that the wall mounting bracket is securely fixed to the monitor and to the wall.

- 1 If you use screws longer than the standard length, it may damage the inside of the product.
- 2 A non-VESA standard screw may damage the product and cause the monitor to fall. LG Electronics is not liable for any accidents relating to the use of non-standard screws.

Wall Mount (mm)	100 x 100
Standard screw	M4 x L10
Number of screws	4
Wall Mount Plate (Optional)	LSW 149

NOTE

- Use the screws specified by VESA standards.
- The wall mount kit includes the installation guide and all necessary parts.
- The wall mounting bracket is optional. You can obtain optional accessories from your local dealer.
- The length of the screw may differ for each wall mounting bracket. Be sure to use the proper length.
- For more information, please refer to the user manual for the wall mounting bracket.

CAUTION

- Unplug the power cord before moving or installing the monitor to avoid electric shock.
- Installing the monitor on the ceiling or on a slanted wall may result in the monitor falling off, which could lead to injury. Use an authorized LG wall mount and contact the local dealer or qualified personnel.
- Applying excessive force when tightening screws may cause damage to the monitor. Damage caused in this way will not be covered by the product warranty.

- Use the wall mounting bracket and screws that conform to VESA standards. Damage caused by the use or misuse of inappropriate components will not be covered by the product warranty.
- When measured from the back of the monitor, the length of each installed screw must be 8 mm (0.3 inches) or less.

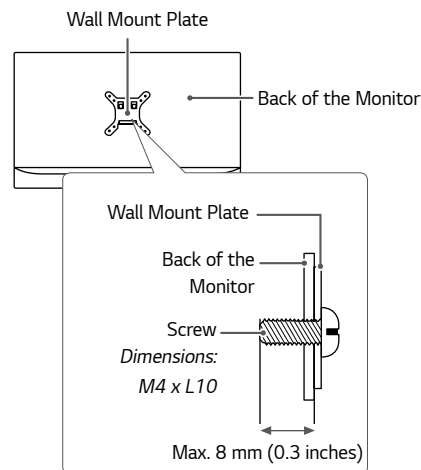

USING THE MONITOR

- The following instructions are based on the 38GL950G model. Illustrations in this manual may differ from the actual product.
- Press the joystick button, go to **Settings** → **Input**, and then select the input option.



CAUTION

- Do not press the screen for a prolonged time. This may cause image distortion.
- Do not display a still image on the screen for a prolonged time. This may cause image retention. Use a screensaver if possible.



NOTE

- When connecting the power cord to the outlet, use a grounded (3-hole) power strip or a grounded power outlet.
- The monitor may flicker when turned on in an area where the temperature is low. This is normal.
- Sometimes red, green, or blue spots may appear on the screen. This is normal.

Connecting to a PC

- This monitor supports the *Plug and Play feature.
- * Plug and Play: A feature that allows you to add a device to your computer without having to reconfigure anything or install any manual drivers.

HDMI Connection

Transmits digital video and audio signals from your PC to the monitor.



CAUTION

- Using a DVI to HDMI / DP (DisplayPort) to HDMI cable may cause compatibility issues.
- Use a certified cable with the HDMI logo attached. If you do not use a certified HDMI cable, the screen may not display or a connection error may occur.
- Recommended HDMI cable types
 - High-Speed HDMI®/™ cable
 - High-Speed HDMI®/™ cable with Ethernet

DisplayPort Connection

Transmits digital video and audio signals from your PC to the monitor.

NOTE

- There may be no video or audio output depending on the DP (DisplayPort) version of the PC.
- Make sure to use the supplied DisplayPort cable of the product. Otherwise, this may cause the device to malfunction.
- If you are using a Mini DisplayPort output graphics card, use a Mini DP to DP (Mini DisplayPort to DisplayPort) cable or gender that supports DisplayPort1.4. (sold separately)

Connecting AV Devices

HDMI Connection

HDMI transmits digital video and audio signals from your AV device to the monitor.

NOTE

- Using a DVI to HDMI / DP (DisplayPort) to HDMI cable may cause compatibility issues.
- Use a certified cable with the HDMI logo attached. If you do not use a certified HDMI cable, the screen may not display or a connection error may occur.
- Recommended HDMI cable types
 - High-Speed HDMI^{®/TM} cable
 - High-Speed HDMI^{®/TM} cable with Ethernet

Connecting Peripherals

USB Device connection

The USB port on the product functions as a USB hub.

! NOTE

- It is recommended you install all Windows Updates to keep your Windows up-to-date before connecting to the product for use.
- Peripheral devices are sold separately.
- A keyboard, mouse, or USB device can be connected to the USB port.
- The charging speed may vary depending on the device.

! CAUTION

- Cautions When Using a USB Device
 - A USB device with an automatic recognition program installed, or that uses its own driver, may not be recognized.
 - Some USB devices may not be supported or may not work properly.
 - It is recommended to use a USB hub or hard disk drive with power supplied. (If the power supply is not adequate, the USB device may not be recognized properly.)

Connecting Headphones

Connect peripherals to the monitor via the headphones port.

! NOTE

- Peripheral devices are sold separately.
- If you use angled earphones, it may cause a problem with connecting another external device to the monitor. Therefore, it is recommended to use straight earphones.



Angled

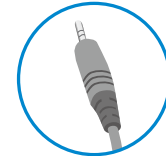

Straight
(Recommend)

- Depending on the audio settings of the PC and external device, headphones and speaker functions may be limited.

Service only port

This port is used only for "Service".

USER SETTINGS





NOTE

- Your monitor's OSD (On Screen Display) may differ slightly from that shown in this manual.

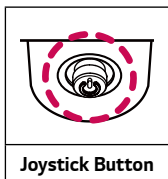
Activating the Main Menu



- 1 Press the joystick button on the bottom of the monitor.
- 2 Move the joystick up/down and left/right to set the options.
- 3 Press the joystick button once more to exit the main menu.

Button	Menu Status	Description
	Main menu disabled	Enables the main menu.
	Main menu enabled	Exits the main menu. (Holding down the button more than 10 seconds to turn off the monitor. You can turn off the monitor this way at any time, including when the OSD is on.)
	◀ Main menu disabled	Adjusts the monitor volume level.
	◀ Main menu enabled	Enters the Input features.
	▶ Main menu disabled	Adjusts the monitor volume level.
	▶ Main menu enabled	Enters the Settings feature.
	▲ Main menu disabled	Adjusts the monitor brightness level. (for SDR only)
	▲ Main menu enabled	Turns off the monitor.
	▼ Main menu disabled	Adjusts the monitor brightness level. (for SDR only)
	▼ Main menu enabled	Enters the Game Mode feature. (for SDR only)

Main Menu Features

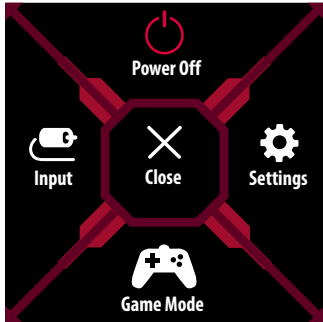

Main Menu	Description
Input	Sets input mode.
Power Off	Turns off the monitor.
Settings	Configures the screen settings.
Game Mode	Sets the game mode for gaming.
Close	Closes the main menu.

Menu Settings

- 1 To view the OSD menu, press the joystick button at the bottom of the monitor and then enter the **Settings**.
- 2 Move the joystick up/down and left/right to set the options.
- 3 To return to the upper menu or set other menu items, move the joystick to ◀ or pressing (🎮) it.
- 4 If you want to exit the OSD menu, move the joystick to ◀ until you exit.



Game Mode



Game Adjust



Picture Adjust



Input





General

Game Mode (for SDR only)

Settings > Game Mode		Description
Game Mode	Gamer 1	In Gamer 1 and Gamer 2 mode, you can save customized settings for Black Stabilizer and Response Time . Select the desired mode for use.
	Gamer 2	
	FPS	This mode is optimized for FPS games. It is suitable for very dark FPS games.
	RTS	This mode is optimized for RTS Game.
	Reader	Optimizes the screen for viewing documents. You can brighten the screen in the OSD menu.
	sRGB	A standard RGB color space for the monitor and printer.
	 NOTE <ul style="list-style-type: none"> Game Mode can not be selected when HDR is activated. 	

Game Adjust

Settings > Game Adjust		Description	
Game Adjust	Overclock	On	Sets Overclock to a higher refresh rate than specified by the panel specification.
		Off	Disables the Overclock improvement feature.
		 NOTE <ul style="list-style-type: none"> • After the monitor reboots, change the maximum refresh rate setting in the NVIDIA control panel. • If the screen display appears abnormal, turn off the Overclock setting. • The function can only be used through DisplayPort. • The Overclock function's features/performance may vary depending on the graphics card or gaming content. • We do not guarantee the performance of the function and are not responsible for any side effects that may occur from its activation. 	
	Black Stabilizer (for SDR only)	You can control the black contrast to have better visibility in dark scenes. You can easily distinguish objects on dark game screens.	
		High	Sets the black stabilizer to High.
		Middle	Sets the black stabilizer to Middle.
		Low	Sets the black stabilizer to Low.
		Off	Does not use the black stabilizer improvement feature.

Settings > Game Adjust		Description	
Game Adjust	Response Time	Sets a response time for displayed pictures based on the speed of the screen. For a normal environment, it is recommended that you use Fast . For a fast-moving picture, it is recommended that you use Faster . Once Faster Mode is selected, Motion Blur may occur depending on the content.	
		Faster	Sets the response time to faster.
		Fast	Sets the response time to fast.
		Normal	Sets the response time to normal.
		Off	Does not use the response time improvement feature.
	 NOTE <ul style="list-style-type: none"> When Response Time is on, 3840 x 1600 @ 30Hz resolution is not supported. 		
	Cross Hair	Cross hair provides a mark on the center of the screen for First Person Shooter (FPS) games. Users can select the cross hair that fits their gaming environment among four different cross hairs. <ul style="list-style-type: none"> When the monitor is off or enters sleep mode, the Cross Hair feature is automatically turned off. Cross Hair and FPS Counter feature can not used at the same time. 	
	FPS Counter	On	The indicator is displayed on the upper left of the screen. It will reflect the actual refresh rate that is received at the input.
		Off	Does not use the FPS Counter feature.
		 NOTE <ul style="list-style-type: none"> When the monitor is off or enters sleep mode, the FPS Counter feature is automatically turned off. FPS Counter and Cross Hair feature can not used at the same time. 	
Game Reset	Returns game to the default settings.		

Picture Adjust

Settings > Picture Adjust	Description		
Picture Adjust	Brightness/Contrast	Adjusts the color contrast and brightness of the screen. (for SDR only)	
	Gamma	Custom gamma settings: Mode 1 , Mode 2 , Mode 3 . (for SDR only) The higher the gamma value, the darker the image becomes. Likewise, the lower the gamma value, the lighter the image becomes.	
	Color Temp	Custom	The user can adjust it to red, green, or blue by customization.
		Warm	Sets the screen color to a reddish tone.
		Medium	Sets the screen color to between a red and blue tone.
		Cool	Sets the screen color to a bluish tone.
	R/G/B	You can customize the picture color using red, green, and blue colors.	
	Variable Backlight	Provides global dimming effects depending on game or video content.	
		Faster(Gaming)	Preferably for PC gaming experiences.
		Fast(Hybrid)	Preferably for console gaming experiences.
		Normal(Desktop)	Preferably for playing video content and internet or word-processing.
		Off	Disables the Variable Backlight feature.
	 NOTE <ul style="list-style-type: none"> • When these feature is enabled, a slight halo effect may be shown on dark backgrounds. This is normal and not a malfunction. • It is recommended to turn off when you are not using the gaming function. 		
Picture Reset	Returns picture and color to the default settings.		

Input

Settings > Input		Description	
Input	Input List	Selects the input mode.	
	Aspect Ratio	Adjusts the aspect ratio of the screen.	
		Full Wide	Displays the video in widescreen, regardless of the video signal input.
		Original	Displays video according to the aspect ratio of the video signal input.
	 NOTE <ul style="list-style-type: none"> The display may look the same for Full Wide, Original options at the recommended resolution. (Recommended Resolution: 3840 x 1600 @ 60 Hz) 		
Auto Input Switch	When automatic input switch is set to On , display will automatically switch to new input when connected.		

General

Settings > General		Description	
General	Language	Sets the menu screen to the desired language.	
	Power LED	Turns the power LED on the bottom of the monitor on or off.	
		On	The power LED turns on automatically. <ul style="list-style-type: none"> • On Mode: Red • Sleep Mode: Flashing Red • Off Mode: Off
		Off	The power LED turns off.
	Lighting Option	Keep Lighting Status	When the monitor turns off, the lighting on the back of the monitor is always on.
		Turn Off Lighting	When the monitor turns off, the lighting on the back of the monitor turns off. When the monitor turns on, the last selected lighting status turns on. <p> NOTE</p> <ul style="list-style-type: none"> • When the monitor turns off, you can't turn on the lighting on the back of the monitor. • To turn on the lighting while the monitor is off, change to 'Keep Lighting Status'.
	Automatic Standby	Feature that automatically turns off the monitor when there is no movement on the screen for a period of time. You can set a timer for the auto-off function. (Off, 4H, 6H, and 8H)	

Settings > General		Description	
General	OSD Lock	This feature disables the configuration and adjustment of menus.	
		On	Enables OSD Lock .
		Off	Disables OSD Lock .
		 NOTE <ul style="list-style-type: none"> The menus except the menus below are disabled. <ul style="list-style-type: none"> - Picture Adjust: Brightness/Contrast - Input - General: OSD Lock, Information 	
	Deep Sleep	This feature turns the monitor off when there is no signal detected from the HDMI or DisplayPort input after approximately 13 minutes.	
		On	Enables Deep Sleep .
		Off	Disables Deep Sleep .
	Information	The following display information will be shown; the Model, Total power on time, Resolution, Mode, Input, Format, Range and EOTF.	
	Reset to Initial Settings	Restores the default settings.	

TROUBLESHOOTING

Nothing is displayed on the screen.	
Is the monitor's power cord plugged in?	<ul style="list-style-type: none"> • Check if the power cord is correctly plugged into the power outlet. Check the power outlet using a different device such as a lamp.
Is the monitor's adapter plugged in?	<ul style="list-style-type: none"> • Make sure to use the adapter that is provided in the product package
Is the power LED on?	<ul style="list-style-type: none"> • Check the power cable connection and press the power button.
Is the power on and the power LED displaying red?	<ul style="list-style-type: none"> • Check that the connected input is enabled (Settings > Input).
Is the The screen is not currently set to the recommended resolution. If you have no video or the screen flickers, see the troubleshooting guide in the product owner's manual. message being displayed?	<ul style="list-style-type: none"> • This occurs when signals transferred from the PC (graphics card) are out of the recommended horizontal or vertical frequency range of the monitor. Please see the Product Specification section of this manual to set the appropriate frequency.
Is the No Signal message being displayed?	<ul style="list-style-type: none"> • This is displayed when the signal cable between the PC and the monitor is missing or disconnected. Check the cable and reconnect it.
Did you check your version of Windows OS?	<ul style="list-style-type: none"> • It is recommended that at least Windows OS version 10 should be installed.
Screen display is unstable and shaky. / Images displayed on the monitor leave shadow trails.	
Did you select the appropriate resolution?	<ul style="list-style-type: none"> • If the selected resolution is HDMI 1080i 60/50 Hz (interlaced), the screen may be flickering. Change the resolution to 1080p or the recommended resolution. • Not setting the graphics card to the recommended (optimal) resolution may result in blurred text, a dimmed screen, a truncated display area or misalignment of the display. • The setting methods may be different depending on the computer or operating system, and some resolutions may not be available depending on the performance of the graphics card. If this is the case, contact the manufacturer of the computer or graphics card for assistance.

Does image sticking occur even when the monitor is turned off?	<ul style="list-style-type: none"> • Displaying a still image for a prolonged time may cause damage to the screen, resulting in the retention of the image. • To extend the lifetime of the monitor, use a screensaver.
Are there spots on the screen?	<ul style="list-style-type: none"> • When using the monitor, pixilated spots (red, green, blue, white, or black) may appear on the screen. This is normal for an LCD screen. It is not an error, nor is it related to the monitor's performance.
Some features are disabled.	
Are some functions not available when you press the Menu button?	<ul style="list-style-type: none"> • The OSD is locked. Disable OSD Lock in General. • Check the PC settings and input signal. (HDR, No Signal)
Do you see an "Unrecognized monitor, Plug and Play (VESA DDC) monitor found" message?	
Have you installed the display driver?	<ul style="list-style-type: none"> • Be sure to install the display driver from our web site: http://www.lg.com. • Make sure to check if the graphics card supports Plug and Play function.
No sound from the headphone port.	
Are images displayed without sound?	<ul style="list-style-type: none"> • This model doesn't support an internal speaker. • Make sure that the headphone port connections are made properly. • Try increasing the volume with the joystick. • Set the audio output of the PC to the monitor you are using. (The settings may differ depending on the operating system (OS) you use.)
The Lighting on the back of the monitor does not turn on.	
Is the monitor's power cord plugged in?	<ul style="list-style-type: none"> • Check if the power cord is correctly plugged into the power outlet. Check the power outlet using a different device such as a lamp.
Is the monitor's adapter plugged in?	<ul style="list-style-type: none"> • Make sure to use the adapter that is provided in the product package.
Did you press the Lighting Button?	<ul style="list-style-type: none"> • Press the Lighting Button located at the bottom of the monitor.

PRODUCT SPECIFICATION

LCD Screen	Color Depth	HDMI	8-bit / 10-bit color is supported.
		DP (DisplayPort)	8-bit / 10-bit color is supported.
Resolution	HDMI	Max Resolution	3840 x 1600 @ 85 Hz
		Recommended Resolution	3840 x 1600 @ 60 Hz
	DP	Max Resolution	3840 x 1600 @ 144 Hz 3840 x 1600 @ 175 Hz (Overclock: On)
		Recommended Resolution	3840 x 1600 @ 60 Hz
Power Sources	Power Rating	19.5 V --- 8.0 A	
	Power Consumption (Typical)	Operating Mode: 85 W (Typical)* Sleep Mode: ≤ 0.5 W (Deep Sleep: On) Off Mode: ≤ 0.5 W (Deep Sleep: On)	
AC/DC Adapter	ACC-LATP1, manufactured by SHENZHEN HONOR ELECTRONIC Output: 19.5 V --- 10.8 A		
Environmental Conditions	Operating Conditions	Temperature	0 °C to 40 °C (32 °F to 104 °F)
		Humidity	Less than 80 %
	Storing Conditions	Temperature	-20 °C to 60 °C (-4 °F to 140 °F)
		Humidity	Less than 85 %

Dimensions	Monitor Size (Width x Height x Depth)	
	With Stand	896.4 x 551.2 x 286.8 (mm) 35.2 x 21.7 x 11.2 (inches)
	Without Stand	896.4 x 394.4 x 111.3 (mm) 35.2 x 15.5 x 4.3 (inches)
Weight (Without Packaging)	With Stand	10 kg (22 lbs)
	Without Stand	7.6 kg (16.7 lbs)

Specifications are subject to change without notice.

* The Operating Mode of Power Consumption is measured with LGE test standard. (Full White pattern, Maximum resolution)

* The Power Consumption level can be different by operating condition and monitor setting.

Factory Support Mode

(Preset Mode, HDMI/ DisplayPort PC)

Preset Mode	Horizontal Frequency (kHz)	Vertical Frequency (Hz)	Polarity (H/V)	Remarks
640 x 480	31.469	59.94	-/-	HDMI/DisplayPort
800 x 600	37.879	60.317	+/+	HDMI/DisplayPort
1024 x 768	48.363	60	-/-	HDMI/DisplayPort
2560 x 1440	88.79	59.95	+/-	HDMI
2560 x 1440	183	120	+/-	HDMI
3840 x 1600	48.69	30	+/-	HDMI
3840 x 1600	98.75	59.99	+/-	HDMI/DisplayPort
3840 x 1600	141.56	84.97	+/-	HDMI/DisplayPort
3840 x 1600	167.75	99.97	+/-	DisplayPort
3840 x 1600	203.25	119.98	+/-	DisplayPort
3840 x 1600	246.81	144	+/-	DisplayPort
3840 x 1600	268.56	159.95	+/-	DisplayPort (Overclock)
3840 x 1600	304.62	174.97	+/-	DisplayPort (Overclock/YUV)

HDMI Timing (Video)

Preset Mode	Horizontal Frequency (kHz)	Vertical Frequency (Hz)
480p	31.5	60
576p	31.25	50
720p	45	60
720p	37.5	50
1080p	67.5	60
1080p	56.25	50
1080p	135	120

Power LED

Mode	LED Color
On Mode	Red (For a few seconds)
Sleep Mode	Off
Off Mode	Off

HDR Monitor

- The monitor supports HDR function, when detecting HDR content, an 'HDR' message will pop up in the upper right corner of the monitor. The HDR status will be displayed as 'On' in the monitor OSD menu.
- HDR content may not be operated properly depending on the Windows 10 OS settings. Please check HDR On / Off setting of Windows.
- When the HDR function is turned on, the characters or picture quality may be poor according to graphic card performance.

G-SYNC Monitor

- The monitor is purposely supporting the NVIDIA G-SYNC technology and targeting NVIDIA GPU.
- Requirement for using G-SYNC
 - Supported Interface: DisplayPort (System must support DisplayPort 1.4 directly from the GPU.)
 - Supported Graphic Card: A graphic card that supports NVIDIA's G-SYNC is necessary. (NVIDIA Pascal GPU Graphics Card like GTX 1070, GTX 1080 or higher.)
 - Supported Version: Make sure to update the graphic card to the latest driver.
 - Supported OS: Windows 10 64bit
- This monitor supports '**Adaptive Sync**' on DP and HDMI-VRR on HDMI. (for Xbox One VRR)
- For more information and requirement, refer to NVIDIA website at <http://www.geforce.com/hardware/technology/g-sync>.



Supplier's Declaration of Conformity

Trade Name	LG
Responsible Party	LG Electronics USA, Inc.
Address	1000 Sylvan Ave Englewood Cliffs, NJ 07632
Telephone	(201)266-2215

The model and serial number of the product are located on the back and on one side of the product.

Record them below in case you ever need service.

Model _____

Serial No. _____