

Philips  
Professional TV

32" Studio  
DVB-T2/T/C HEVC

32HFL2869T



## Delight your guests

with pure taste

Show your guests how much you care with this affordable Hospitality TV. You will enjoy dedicated hospitality features like a branded welcome page, installation via USB and menu and control locking.

### **Great viewing experience and guest comfort**

- LED TV for images with incredible contrast
- Low power consumption
- USB for multimedia playback

### **Advanced hotel features and future proof**

- Greet your guests with a customizable welcome page
- USB cloning of all settings for quick installation
- Off-line channel editor to edit a channel list on a PC
- One combined channel list for Analog and Digital channels
- Installation menu locking
- Prevent unauthorized use by joystick control locking
- Advanced volume control to avoid guest disturbance
- Ideally suited for prisons

# PHILIPS

# Highlights

## Welcome page



A welcome page is displayed each time the TV set is switched on. The welcome page can be branded and customized easily at the time of installation via a simple welcome image in .png format.

## USB Cloning



Provides the ability to easily copy all programming and channel programming settings from one TV into other TV sets in less than a minute. The feature ensures uniformity

between TV sets and significantly reduces installation time and costs.

## PrisonMode

To control communication, this Hospitality TV is equipped with a specific PrisonMode setting. This Advanced Security Mode switches off certain settings not demanded by the detention market like Teletext, Electronic Programme Guide, Subtitles and USB ports.

## USB (photos, music, video)



Share the fun. Connect your USB memory-stick, digital camera, mp3 player or other multimedia device to the USB port on your TV to enjoy photos, videos and music with the easy to use onscreen content browser.

## One combined channel list

One integrated channel list for digital and analogue channels. This allows the guest to

zap seamlessly between Analogue and Digital channels.

## Advanced volume control

With advanced volume control you can install the start-up volume of the TV and predetermine the volume range with which the TV set is allowed to operate, preventing excessive volume adjustments and avoiding disturbance of next door guests.

## Joystick control locking

By disabling or enabling the joystick control locking, the administrator can prevent unauthorized use of the TV via the joystick, saving the hotelier overheads.

## Installation menu locking

Prevents unauthorized access to installation and configuration settings, to ensure maximum guest convenience and avoid unnecessary reinstalling costs.

## Low power consumption

Philips TVs are designed to minimize power consumption. This will not only reduce environmental impact but also lower operating costs.

# Specifications

## Picture/Display

- Display: LED HD TV
- Diagonal screen size: 32 inch / 80 cm
- Aspect ratio: 16:9
- Panel resolution: 1366 x 768p
- Brightness: 300 cd/m<sup>2</sup>
- Viewing angle: 178° (H) / 178° (V)
- Contrast ratio (typical): 4000

## Audio

- Sound output Power: 12 (2x6) W
- Speakers: 2.0, Down Firing
- Sound Features: Equalizer, Balance, AVL, Incredible surround, Dynamic Bass

## Design

- Colour: Black

## Tuner/Reception/Transmission

- Digital TV: DVB-T/T2/C, HEVC FHD (up to 1080p60)
- Analog TV: PAL, SECAM

## Connectivity Rear

- Antenna: IEC-75
- HDMI1: HDMI 1.4, ARC
- HDMI2: HDMI 1.4
- Digital Audio out: Optical
- Scart: CVBS, RGB, SVHS
- VGA input: 15 pin D-sub

## Connectivity Side

- Common Interface Slot: CI+ 1.3
- AV input: CVBS+L/R (Cinch)
- Headphone out: Mini-Jack
- USB1: USB 2.0

## Connectivity Enhancements

- EasyLink (HDMI CEC): One touch play, System Standby, RC pass through

## Features

- Digital services: Subtitles, Teletext, MHEG, Now&Next, 8d EPG
- Ease of use: Picture Style, Sound Style
- Local control: Joystick

## Hospitality Features

- Hotel mode: Joystick Control Lock, Menu lock,

Installation Menu Lock, Volume limitation (incl. HP)

- Prison mode: high security mode, TXT/MHEG/USB/EPG/Subtitle Lock
- Your brand: Welcome Logo
- Cloning and Firmware update: via USB, Instant Initial Cloning
- Switch On control: Channel/Source, Picture Style, Volume (incl. HP)
- Timer: Sleep Timer, Wake Up Alarm
- Channels: Combined List, Off-Line Channel Editor
- Control: Block Automatic Channel Update
- Power control: Green/fast startup
- Remote Control: Cable Strap Ready, RC Battery Door Lock
- Anti-Theft: Kensington Lock

## Healthcare features

- Control: Multi-Remote Control
- Convenience: Headphone out

## Multimedia

- Multimedia connections: USB
- Video playback supported: Containers: AVI, MKV, Formats: H.264/MPEG4 AVC, MPEG1, MPEG2, MPEG4, HEVC, TS
- Subtitle formats supported: SRT, SSA SUB, ASS, SMI, TXT
- Music formats supported: MP3, AAC, WAV, WMA (v2 up to v9.2)
- Picture formats supported: BMP, JPG, PNG
- Supp. Video Resolution on USB: up to 1920x1080p@30Hz

## Accessories

- Included: Remote Control 22AV1407A/12, 2xAAA Batteries, Tabletop Stand, Warranty Leaflet, Legal and Safety brochure
- Optional: Setup RC 22AV9573A, Remote Control 22AV1601A/12

## Power

- Mains power: AC 220-240V; 50-60Hz
- Energy Label Class: A+
- Eu Energy Label power: 31 W
- Annual energy consumption: 45 kW h
- Standby power consumption: <0.3 W
- Power Saving Features: Eco mode
- Ambient temperature: 5 °C to 45 °C

## Dimensions

- Set dimensions (W x H x D): 735 x 438 x 77/89 mm
- Set dimensions with stand (W x H x D): 735 x 476 x 185 mm
- Product weight: 5.1 kg
- Product weight (+stand): 5.6 kg
- VESA wall mount compatible: M4, 200 x 100 mm

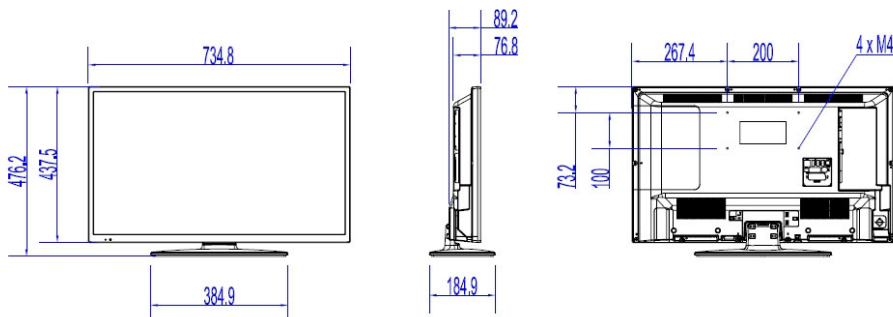

Issue date 2017-10-05

Version: 1.0.1

12 NC: 8670 001 47626  
EAN: 87 18863 01377 9

© 2017 Koninklijke Philips N.V.  
All Rights reserved.

Specifications are subject to change without notice.  
Trademarks are the property of Koninklijke Philips N.V.  
or their respective owners.

[www.philips.com](http://www.philips.com)

\* Availability of features will depend on implementation chosen by integrator.  
\* Typical on-mode power consumption measured according to IEC62087 Ed 2. The actual energy consumption will depend on how the television is used.  
\* This television contains lead only in certain parts or components where no technology alternatives exist in accordance with existing exemption clauses under the RoHS Directive.