

SRD-830/830D/1610/1610D/1630/1630D
SRD-850/850D/1650/1650D
SRD-870/870D/1670/1670D

8 Channel/16 Channel DVR User Manual

imagine the possibilities

Thanks you for purchasing this Samsung product.
To receive a more complete service, please visit
our website

www.samsungsecurity.com



overview

FEATURES

This DVR (Digital Video Recorder) employs H.264 video encoding for 8 or 16 channels of camera input and G.723 audio encoding for 4 or 16 channels, and supports simultaneous hard disc recording and playback. And also it supports network connectivity, providing remote monitoring from a remote PC by transferring video and audio data.

- Provides convenient User Interface
- 8/16 CH Composite Input Connectors
- Supports CIF(S)/Half D1(M)/Full D1(L) recording formats
- With the network specific codec, network transfer enabled regardless of the recording conditions
- De-interlacing processor for better picture quality
- HDMI enabling superior picture output quality
- Display of HDD information and status by using HDD SMART
- D1 Size (NTSC: 704*480, PAL: 704*576) Recording in 480 (NTSC)/400 (PAL) IPS speed (SRD-870/870D/1670/1670D)
- CIF(S) Size (NTSC: 352*240, PAL: 352*288) Recording in 480 (NTSC)/400 (PAL) IPS speed (SRD-850/850D/1650/1650D)
- CIF(S) Size (NTSC: 352*240, PAL: 352*288) Recording in 240 (NTSC)/200 (PAL) IPS speed (SRD-1630/1630D)
- CIF(S) Size (NTSC: 352*240, PAL: 352*288) Recording in 120 (NTSC)/100 (PAL) IPS speed (SRD-830/830D/1610/1610D)
- 8/16-channel Loop Through Video port connection
- Hard Disk overwrite function
- Mass storage hard disk backup through high-speed USB 2.0
- Mass storage hard disk backup through eSATA (SRD-850/850D/870/870D/1650/1650D/1670/1670D)
- Backup function using USB 2.0 flash memory and external CD/DVD writer (Internal DVD writer is not available for SRD-830/850/870/1610/1630/1650/1670)
- Simultaneous Record and Playback of 8/16-channel video data
- Various Search Modes (Search by Time, Event, Backup, POS and Motion Detection)
- Various Recording Modes (Time Lapse, Event, Scheduled Recording)
- Extended Hard Disk Connection (USB 2.0, eSATA) (SRD-850/850D/870/870D/1650/1650D/1670/1670D)
- Alarm Interface (Input: 8/16, Output: 4, Reset: 1)
- Remote Monitoring function by Windows Network Viewer

IMPORTANT SAFETY INSTRUCTIONS

Read these operating instructions carefully before using the unit.

Follow all the safety instructions listed below.

Keep these operating instructions handy for future reference.

- 1) Read these instructions.
- 2) Keep these instructions.
- 3) Heed all warnings.
- 4) Follow all instructions.
- 5) Do not use this apparatus near water.
- 6) Clean only with dry cloth.
- 7) Do not block any ventilation openings, Install in accordance with the manufacturer's instructions.
- 8) Do not install near any heat sources such as radiators, heat registers, stoves, or other apparatus (including amplifiers) that produce heat.
- 9) Do not defeat the safety purpose of the polarized or grounding- type plug. A polarized plug has two blades with one wider than the other. A grounding type plug has two blades and a third grounding prong. The wide blade or the third prong are provided for your safety. if the provided plug does not fit into your outlet, consult an electrician for replacement of the obsolete outlet.
- 10) Protect the power cord from being walked on or pinched particularly at plugs, convenience receptacles, and the point where they exit from the apparatus.
- 11) Only use attachments/accessories specified by the manufacturer.
- 12) Use only with the cart, stand, tripod, bracket, or table specified by the manufacturer, or sold with the apparatus. When a cart is used, use caution when moving the cart/apparatus combination to avoid injury from tip-over.
- 13) Unplug this apparatus during lightning storms or when unused for long periods of time.
- 14) Refer all servicing to qualified service personnel. Servicing is required when the apparatus has been damaged in any way, such as power-supply cord or plug is damaged, liquid has been spilled or objects have fallen into the apparatus, the apparatus has been exposed to rain or moisture, does not operate normally, or has been dropped.



overview

BEFORE START

This user's manual provides Information for using DVR such as brief introduction, part names, functions, connection to other equipment, menu setup, and the like.

You have to keep in mind the following notices :

- SAMSUNG retains the copyright on this manual.
- This manual cannot be copied without SAMSUNG's prior written approval.
- We are not liable for any or all losses to the product incurred by your use of non-standard product or violation of instructions mentioned in this manual.
- If you want to open the case of your system for checking problems, please consult the expert from the shop where you bought the product.
- Before installing an additional HDD or connecting an external storage device (USB memory or USB HDD) to this DVR, check the compatibility. Consult your provider for the compatibility list.

Warning

❖ Battery

Exchanging a wrong battery in your product may cause an explosion. Therefore you must use the same type of battery as the one being used in the product.

The following are the specifications of the battery you are using now.

- Normal voltage : 3V
- Normal capacity : 170mAh
- Continuous standard load : 0.2mA
- Operating temperature : -20°C ~ +85°C
(-4°F ~ +185°F)

CALIFORNIA USA ONLY

This Perchlorate warning applies only to primary CR (Manganese Dioxide) Lithium coin cells in the product sold or distributed ONLY in California USA.
"Perchlorate Material - special handling may apply,
See www.dtsc.ca.gov/hazardouswaste/perchlorate."



- Connect the power cord into a grounded outlet.
- The Mains plug is used as a disconnect device and shall stay readily operable at any time.
- Batteries shall not be exposed to excessive heat such as sunshine, fire or the like.

❖ System Shutdown

Turning off the power while the product is in operation, or taking not permitted actions may cause damage to the hard drive or the product. Also it can cause a dysfunction to the hard disk while using the product.

Please turn off the power using the Power button on the front of your DVR.

After selecting <OK> in the pop-up menu, you can pull off the power cord.

You may want to install a UPS system for safe operation in order to prevent damage caused by an unexpected power stoppage. (Any questions concerning UPS, consult your UPS retailer.)

❖ Operating Temperature

The guaranteed operating temperature range of this product is 0°C ~ 40°C (32°F ~ 104°F).

This product may not work properly if you run right after a long period of storage at a temperature below the guaranteed one.

When using the device after a long period of storage at low temperature, place the product at room temperature for a while and run it.

Especially for the built-in HDD in the product, its guaranteed temperature range is 5°C ~ 55°C (41°F ~ 131°F). Likewise, the hard drive may not work at a temperature below the guaranteed one.

❖ Ethernet Port

This equipment is in door use and all the communication wirings are limited to inside of the building.

Standards Approvals









- This equipment has been tested and found to comply with the limits for a Class A digital device, pursuant to part 15 of the FCC Rules. These limits are designed to provide reasonable protection against harmful interference when the equipment is operated in a commercial environment.

This equipment generates, uses, and can radiate radio frequency energy and, if not installed and used in accordance with the instruction manual, may cause harmful interference to radio communications. Operation of this equipment in a residential area is likely to cause harmful interference in which case the user will be required to correct the interference at his own expense.

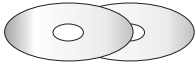
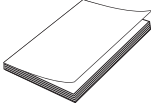
Package Contents

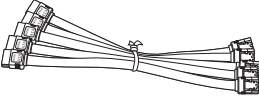
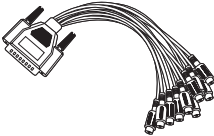
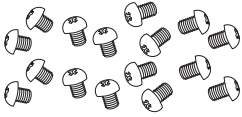
Please unwrap the product, and place the product on a flat place or in the place to be installed. Please check the following contents are included in addition to the main unit.

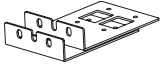
		
<p>Remote Control</p>	<p>Mouse</p>	<p>Power Cable</p>
		
<p>Network Viewer Software / User Manual CD</p>	<p>User Manual</p>	<p>Remote Control Battery (AAA)</p>
		
<p>SATA Cable (SRD-830D/850D/870D/1610D/ 1630D/1650D/1670D : 4EA) (SRD-830/850/870/1610/1630/ 1650/1670 : 5EA)</p>	<p>Audio Extension Cable (optional) (SRD-850/850D/870/870D/ 1650/1650D/1670/1670D)</p>	<p>HDD Fixing Screw (SRD-830D/850D/870D/1610D/1630D/ 1650D/1670D : 16EA) (SRD-830/850/870/1610/1630/1650/ 1670 : 20EA)</p>
		
<p>Bracket Fixing Screw(4EA)</p>	<p>Bracket Rack</p>	



- For models that are not equipped with the HDD, one SATA cable is provided for HDD installation.

overview

CONTENTS

OVERVIEW	2	Features
	3	Important Safety Instructions
	4	Before Start
	8	Part Names and Functions (Front)
	10	Part Names and Functions (Rear)
	13	Remote Control
	2	
INSTALLATION	15	Checking the installation environment
	16	Rack Installation
	16	HDD Addition
	15	
CONNECTING WITH OTHER DEVICE	20	Connecting the Video, Audio, and Monitor
	20	Connecting the USB
	21	Connecting External SATA HDD
	21	Connecting POS Device
	21	Connecting the Alarm Input/Output
	22	Connecting the RS-485 Device
	23	Connecting the Network
	20	
	20	
	21	
	21	
	21	
	22	
	23	
	20	
	20	
	21	
	21	
	21	
	22	
	23	
	25	Getting Started
	27	Live Screen Configuration
	31	Live Mode
	33	Spot Out
	34	Zoom
	34	Audio ON/OFF
	34	Freeze
	35	Event Monitoring
	25	
	27	
	31	
	33	
	34	
	34	
	34	
	35	
	25	
	27	
	31	
	33	
	34	
	34	
	34	
	35	
USING THE DVR	36	System Setup
	46	Setting the Device
	54	Setting the Recording
	57	Setting the Event
	60	Backup
	61	Network Configuration
	68	Controlling a PTZ device
	36	
	46	
	54	
	57	
	60	
	61	
	68	
	36	
	46	
	54	
	57	
	60	
	61	
	68	
	36	
	46	
	54	
	57	
	60	
	61	
	68	

SEARCH & PLAY

70

- 70 Search
- 73 Playback

WEB VIEWER

74

- 74 Introducing Web Viewer
- 75 Connecting Web Viewer
- 77 Using Live Viewer
- 83 Using Search Viewer
- 87 Viewer Setup
- 97 About

BACKUP VIEWER

98

- 98 SEC Backup Viewer

APPENDIX

100

- 100 Product Specification (SRD-830/830D/1610/1610D/1630/1630D)
- 103 Product Specification (SRD-850/850D/870/870D/1650/1650D/1670/1670D)
- 106 Product Overview
- 107 Default Setting
- 110 Troubleshooting

overview

PART NAMES AND FUNCTIONS (FRONT)

830/850/870

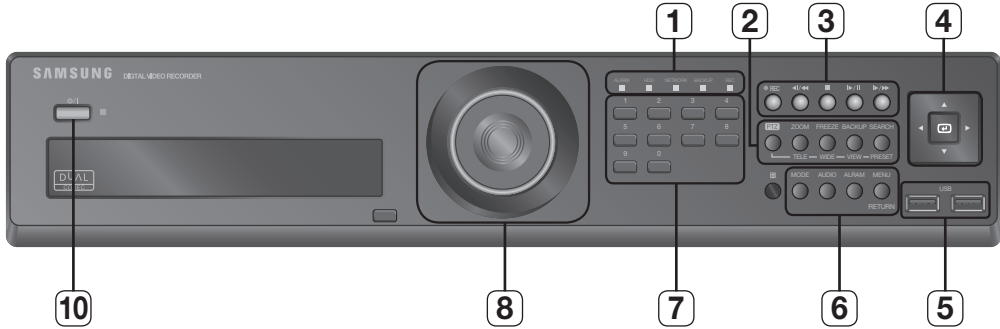

1610/1630/1650/1670

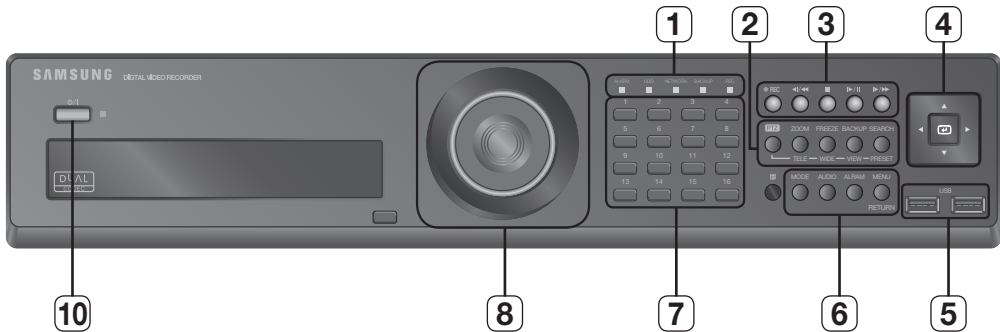

830D/850D/870D

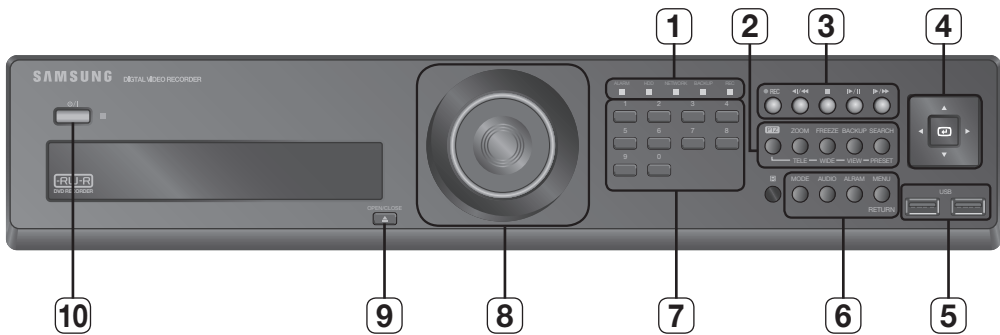

1610D/1630D/1650D/1670D

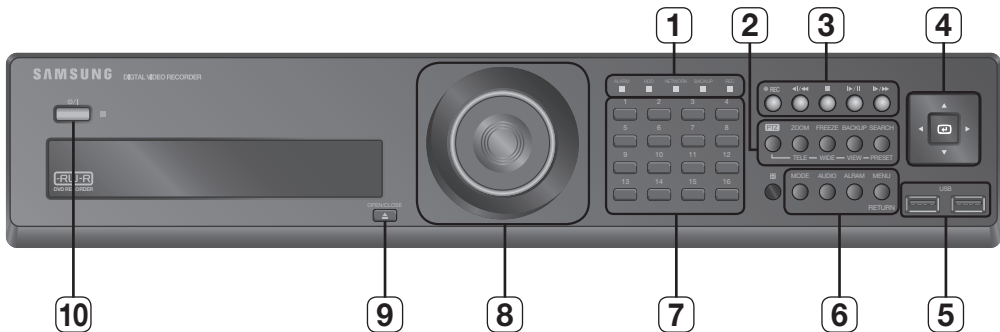

Part Names		Functions
1	LED Indicator	ALARM : Lights on when an event occurs.
		HDD : Displays the normal access to HDD. Upon access to HDD, LED repeats on and off.
		NETWORK : Displays both network connection and data transfer status.
		BACKUP : Displays when Backup is in progress.
		REC : Lights on when recording is in progress.
2	Camera Control	PTZ : Sets PTZ Mode ON/OFF.
		ZOOM(TELE) : Sets the screen to the x2 digital zoom. Runs the TELE function in the PTZ Mode.
		FREEZE(WIDE) : Runs the FREEZE function in the Live Mode. Runs the WIDE function in the PTZ Mode.
		BACKUP(VIEW) : Runs the BACKUP function. Runs the Preset View function in the PTZ Mode.
		SEARCH(PRESET) : Goes to the search screen. Runs the Preset Setup function in the PTZ Mode.
3	REC	Starts or ends the recording.
	◀ /◀◀	Step Rewind (◀) : Used for backward frame-by-frame search while in PAUSE. Fast Rewind (◀◀) : Used for quick backward search while in Play. (-x2, -x4, -x8, -x16, -x32, -x64)
	■	Stop : Used to stop the playback.
	▶/	Play/Pause : Used to pause or resume the screen.
	▶▶/▶	Fast Forward (▶▶) : Used for quick forward playback. (x2, x4, x8, x16, x32, x64) Step Forward (▶) : Used for forward frame-by-frame search while in PAUSE.
4	Direction / Select Button	Used to change a value or move the cursor up/down/left/right (▲▼◀▶). Selects a menu item or executes the selected menu.
5	USB Port 1 / 2	Connects the USB devices.
6	MODE	Each button press in the Live Mode switches the screen to 16-, 9-, 4-, 6-, 8-, 13- split screen, PIP, and auto sequence mode in order. In play mode, each press of the button will switch the screen mode to 13-, 1-, 4-, 9-, and 16-split in order. (1 live channel + (N-1) live channel)
	AUDIO	Sets Audio ON/OFF.
	ALARM	Cancels the ALARM LED and the audible alarm when the alarm is going off, and to remove the icon.
	MENU/RETURN	Either goes to the system menu screen or moves to the upper menu from the lower menu.
7	Channel	Used to select channel numbers directly in the Live Mode, or numbers in the numeric input mode.
8	Jog shuttle	When a scroll bar appears in each menu, acts as a scrolling. In Play mode, - Jog : Pauses the playback and steps backward or forward. - Shuttle : Fast playback forward or backward.
9	OPEN/CLOSE	Used to open and close the DVR-RW disc tray. (available for SRD-830D/850D/870D/1610D/1630D/1650D/1670D only)
10	Power	Power LED : Displays the power ON/OFF status. Power Button : Used to turn the DVR ON/OFF.

overview

PART NAMES AND FUNCTIONS (REAR)

830/830D

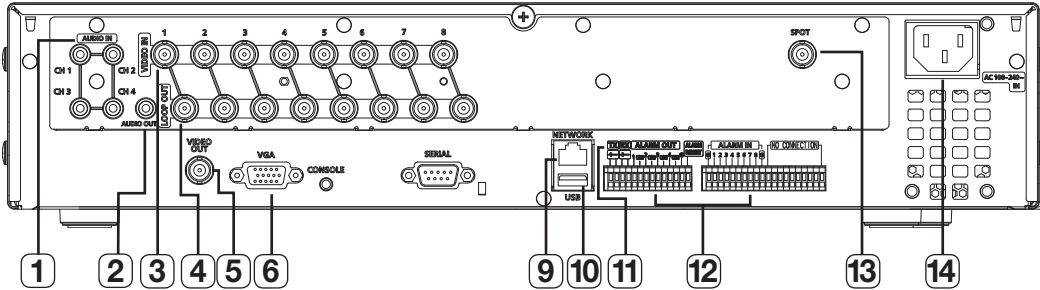

1610/1610D/1630/1630D

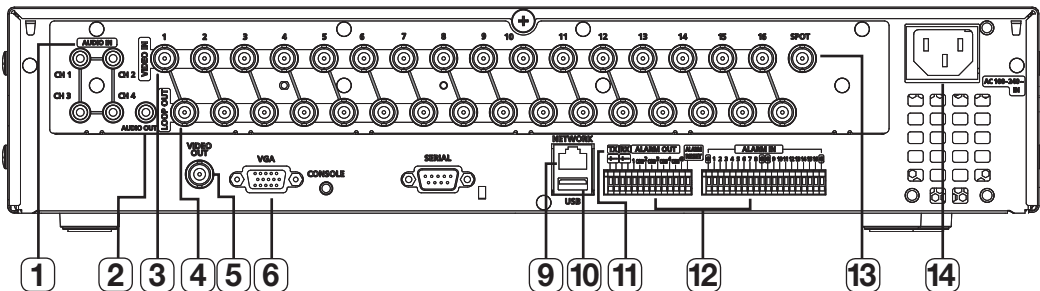

850/850D

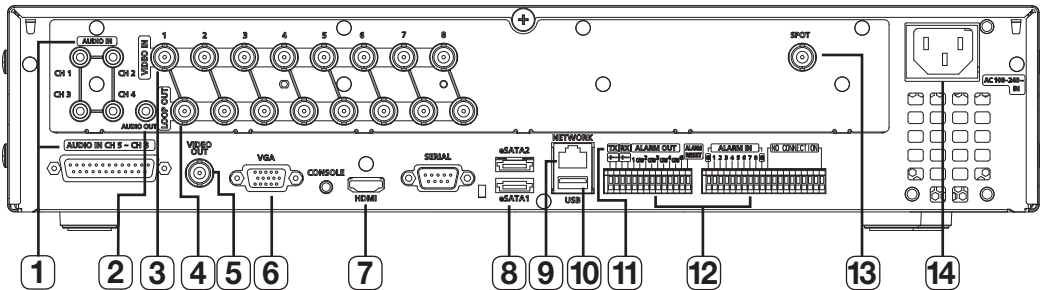

1650/1650D

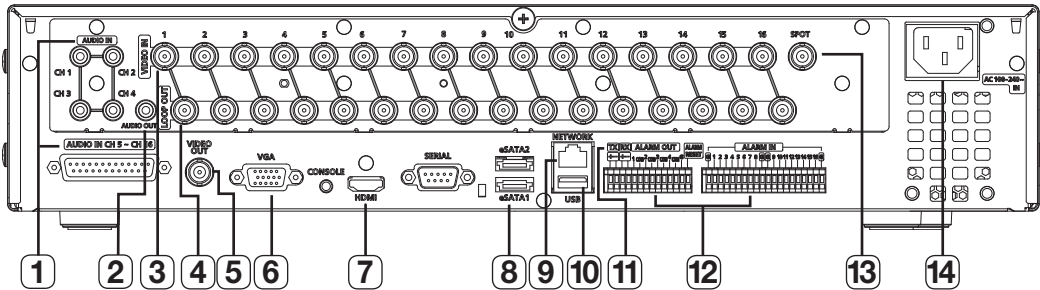

870/870D

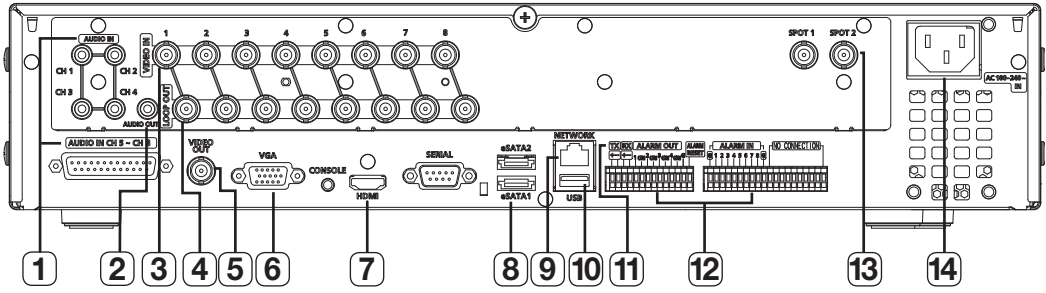

1670/1670D

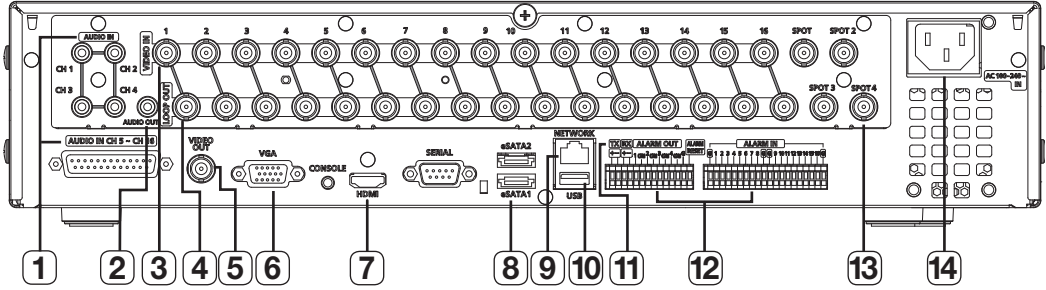

overview

Part Names		Functions
1	AUDIO IN	Audio input signal port (RCA jack) and port for optional audio extension cable. SRD-1650/1650D/1670/1670D (Audio 5~16CH) SRD-850/850D/870/870D (Audio 5~8CH)
2	AUDIO OUT	Audio Signal Output Port (RCA jack).
3	VIDEO IN	Composite Video Signal Input Port (BNC type connector).
4	LOOP OUT	Used to transfer a video signal to other video devices.
5	VIDEO OUT	Composite Video Signal Output Port (BNC type connector).
6	VGA	VGA Video Signal Output Port.
7	HDMI	HDMI connector port.
8	eSATA 1/2	Ports used for external storage device connections. (SATA HDD)
9	NETWORK	NETWORK connector port.
10	USB	USB connector port.
11	RS-485	Used for RS-485 communication. (TX+, TX-, RX+, RX-)
12	ALARM	- ALARM IN 1~16(SRD-1610/1610D/1630/1630D/1650/1650D/1670/1670D) : Alarm Input port. - ALARM IN 1~8(SRD-830/830D/850/850D/870/870D) : Alarm Input port. - ALARM RESET IN : Alarm Reset port. - ALARM OUT 1~4 : Alarm Output port.
13	SPOT	A live screen output port, separate from the VIDEO OUT. SPOT 1 : Supports Single, 4-, 9-, 16-split, and Auto Sequence modes SPOT 2 : Supports Single, 4-split, and Auto Sequence modes (only for 5 ~ 8 CH). SPOT 3 : Supports Single, 4-split, and Auto Sequence modes (only for 9 ~ 12 CH). SPOT 4 : Supports Single, 4-split, and Auto Sequence modes (only for 13 ~ 16 CH). SRD-1670D/1670 : SPOT 1, 2, 3, 4 SRD-870D/870 : SPOT 1, 2 SRD-830/830D/850/850D/1610/1610D/1630/1630D/1650/1650D : SPOT 1
14	AC 100-240V~ IN	AC 100 ~ 230V (PAL) AC 110 ~ 220V (NTSC)

REMOTE CONTROL

DVR

Available after switching to DVR mode by pressing the [DVR] button on the remote control.

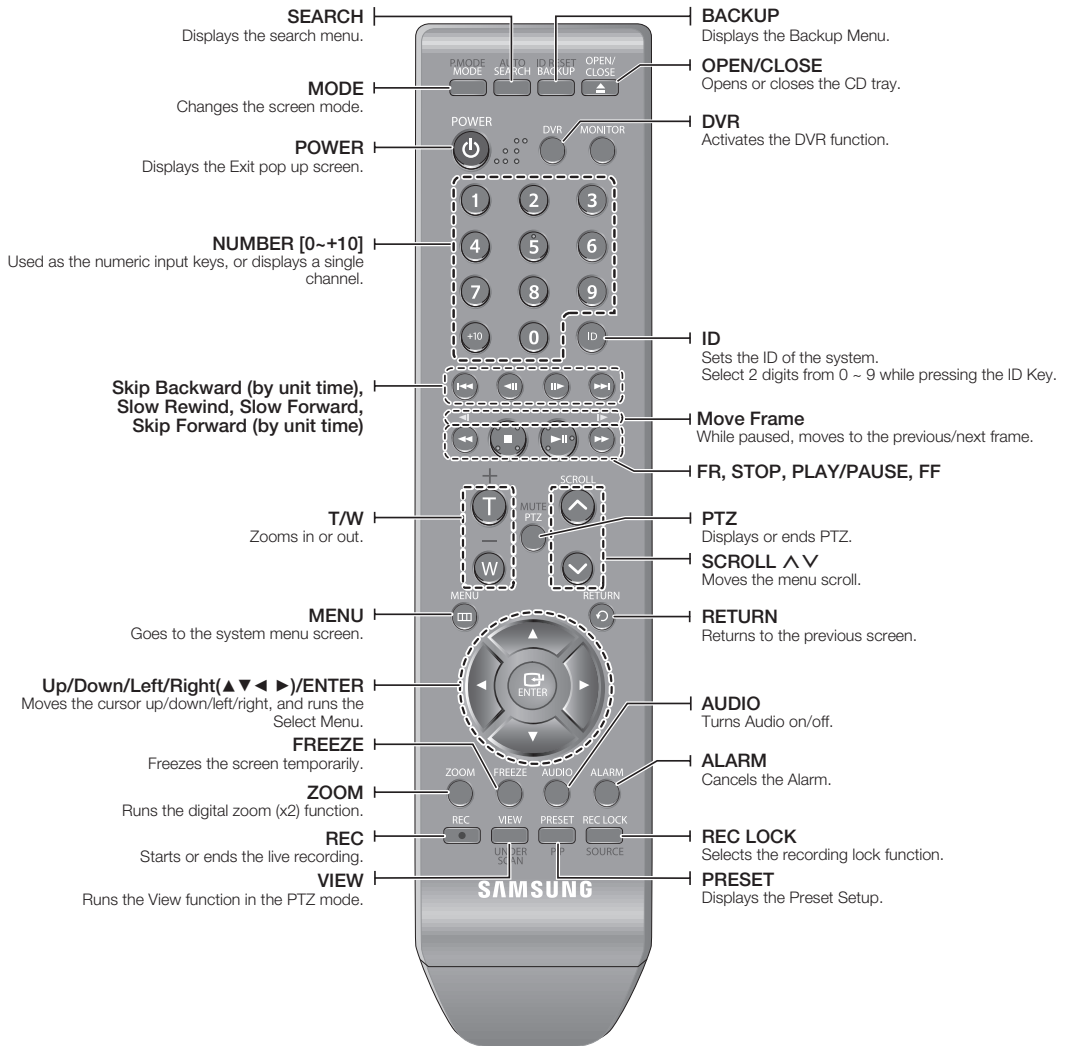

Using the numeric buttons

CHANNEL 1-9	Press each button between 1 to 9.
CHANNEL 10	Press the [+10] button first, then press the 0 button again within 3 seconds.
CHANNEL 11-16	Press the [+10] button first, then press any number between 1 to 6 within 3 seconds.

overview

MONITOR

Available after switching to Monitor mode by pressing the **[MONITOR]** button on the remote control.

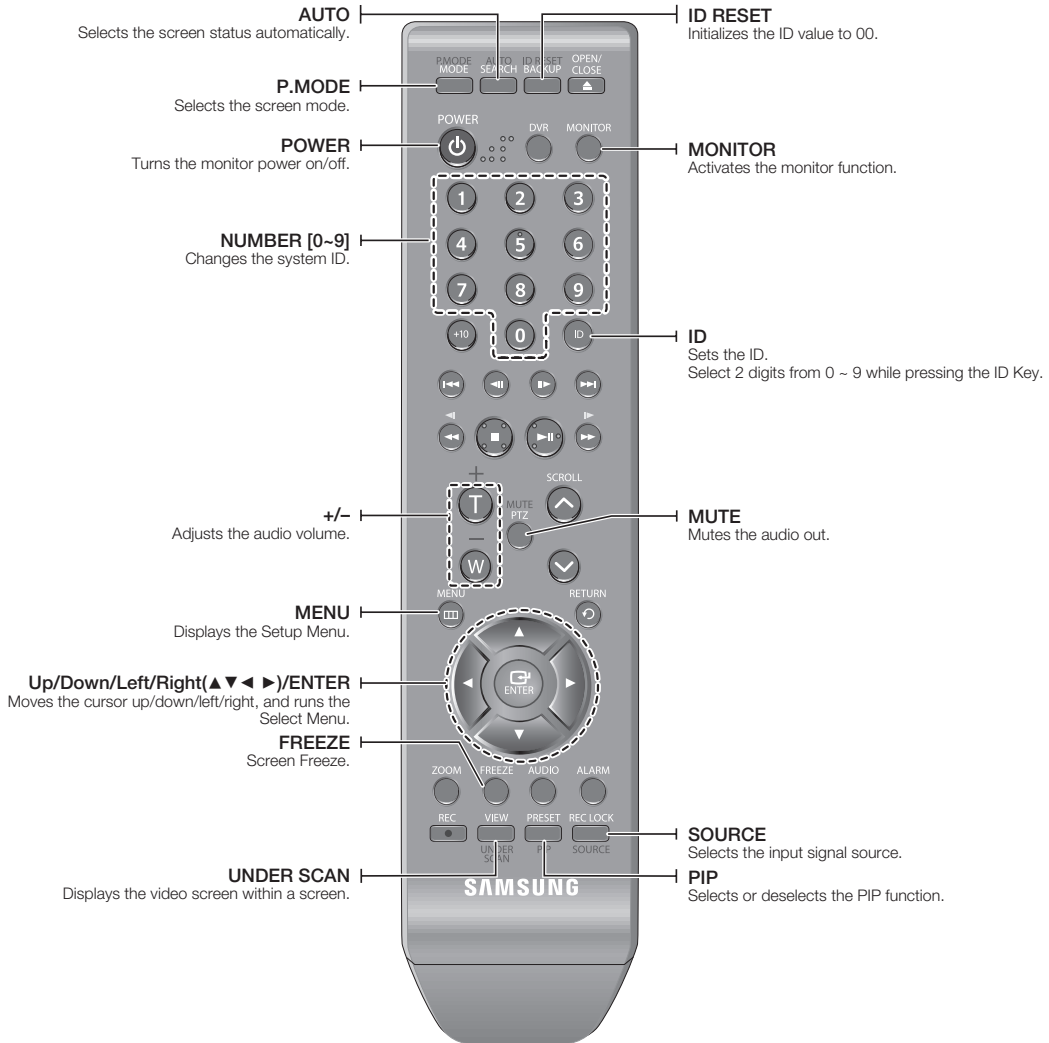

Using the Numeric buttons

CHANNEL 1-9

Press any button among 1 to 9.

Changing the Remote Control ID

1. Press the ID button of the remote control and check the ID displayed on the DVR screen.
The factory default ID of the remote control is 00.
2. Enter 2 digits of your selection in order, while pressing the system **[ID]** button.
3. When ID input is done, press the system **[ID]** button again to check the setting.



- If you want to change the remote control ID to 08: Press 0 and 8 in order while the system **[ID]** button is pressed.
Remote control's ID and DVR's ID should be matched for proper operation. Refer to "**Remote Devices**". (Page 50)

installation

Please be noticed with the followings before you use the product.

- Do not use the product outdoor.
- Do not spill water or liquid in the connection part of the product.
- Do not impose the system to excessive shock or force.
- Do not pull out the power plug forcefully.
- Do not disassemble the product on your own.
- Do not exceed the rated input/output range.
- Use a certified power cord only.
- For the product with an input ground, use a grounded power plug.

CHECKING THE INSTALLATION ENVIRONMENT

Samsung Digital Video Recorder (“DVR” hereinafter) is a state-of-art security device, and contains mass storage hard disk(s) and critical circuits inside.

When the temperature rises inside the product, the product may breakdown and the product life be shortened. Please pay attention to the following recommendations before installation.

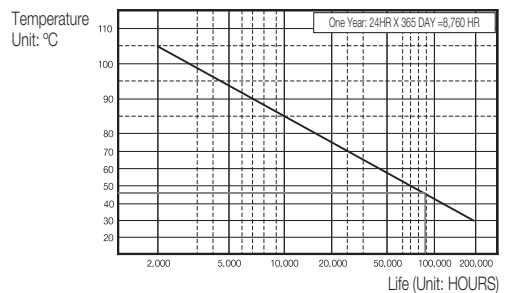

[Figure 1]

The followings are the recommendations when Samsung DVR is installed on a rack.

1. Please ensure that the rack inside is not sealed.
2. Please ensure the air is circulated through the inlet/outlet as shown in the picture.
3. If the DVR or other devices on a rack is to be stacked as in the picture, provide a suitable space or install a ventilating opening for air circulation.
4. For natural air convection, place the inlet at the bottom of the rack and the outlet on top.
5. It is strongly recommended that a fan motor is installed at the inlet and the outlet for air circulation. (Please fit a filter at the inlet to screen dust or foreign substances.)
6. Please maintain the temperature inside the rack or surrounding areas between 0°C ~ 40°C (32°F ~ 104°F) as shown in the figure 1.

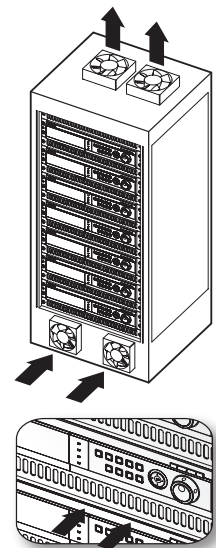

[Figure 2]

Rack Mount Instructions - The following or similar rack-mount instructions are included with the installation instructions :

- A) Elevated Operating Ambient - If installed in a closed or multi-unit rack assembly, the operating ambient temperature of the rack environment may be greater than room ambient. Therefore, consideration should be given to installing the equipment in an environment compatible with the maximum ambient temperature (T_{ma}) specified by the manufacturer.
- B) Reduced Air Flow - Installation of the equipment in a rack should be such that the amount of air flow required for safe operation of the equipment is not compromised.
- C) Mechanical Loading - Mounting of the equipment in the rack should be such that a hazardous condition is not achieved due to uneven mechanical loading.
- D) Circuit Overloading - Consideration should be given to the connection of the equipment to the supply circuit and the effect that overloading of the circuits might have on overcurrent protection and supply wiring. Appropriate consideration of equipment nameplate ratings should be used when addressing this concern.
- E) Reliable Earthing - Reliable earthing of rack-mounted equipment should be maintained. Particular attention should be given to supply connections other than direct connections to the branch circuit (e.g. use of power strips).

installation

RACK INSTALLATION

Loosen the screws on both sides (2 screws on each side) and install the Bracket-Rack as shown in the figure, and then fasten the screws on both sides (2 screws on each side).

- Fix the screws not to be loosened by vibrations.

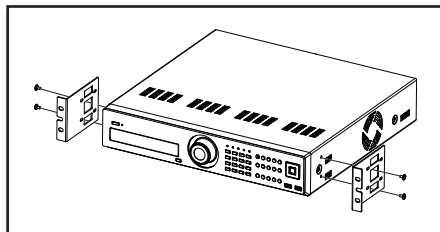

HDD ADDITION

You can install additional HDDs.

Make sure to unplug the power cord from the wall outlet to prevent possible electric shock, injury or product damage.

Please consult your provider for further information on HDD installation since improper installation or settings may damage the product.

- Number of HDDs supported : SRD-830D/850D/870D/1610D/1630D/1650D/1670D : Default 1 HDD + Up to 4 HDDs added
SRD-830/850/870/1610/1630/1650/1670 : Default 1 HDD + Up to 5 HDDs added
- Make sure to unplug the power cord from the wall outlet before proceeding with the installation.
- By factory default, the master unit is equipped with one HDD.
The following instructions are when you have installed the maximum number of HDDs on the master unit.



- **Cautions for data loss (HDD care)**

Please pay attention so that the data inside the HDD is not damaged.

Before adding a HDD, please check the compatibility with this DVR product.

HDD is vulnerable to malfunction due to its sensitive nature against externalities or shocks during operation.

Please ensure that the HDD is free from such shock or externalities.

We are not liable for any damage to the HDD incurred by user's carelessness or externalities.

- **Cases might cause damage to HDD or recorded data**

To minimize the risk of data loss from a damaged HDD, please backup data as often as possible.

Data may be lost due to external impacts during disassembly or installation of the DVR.

HDD may be damaged if the DVR is suddenly stopped by a power cut or power off during operation.

HDD or files stored inside may be damaged if the main body is moved or impacted during the HDD operation.

Cautions when adding a HDD

1. When adding a HDD, pay attention so that the cable does not get caught between unsuitable spaces or the cable's insulation does not come off.
2. Pay attention so as not to lose the disassembly screws or accessories.
 - If the screws or accessories are not put together, the product may breakdown or not operate properly.
3. Please check the HDD compatibility before adding a HDD.
 - Please contact your nearest dealer to obtain the list of compatible devices.

If adding HDDs to SRD-830/850/870/1610/1630/1650/1670

1. First, loosen the screws in the left and right sides and remove the cover.

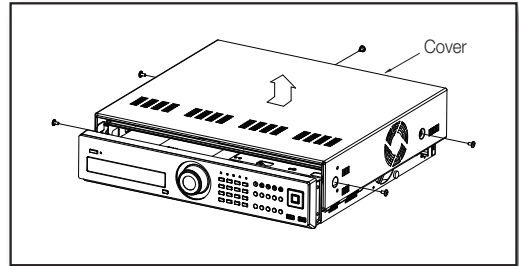

2. Loosen the screws (x4) in the left/right and upper sides and remove the upper brackets.

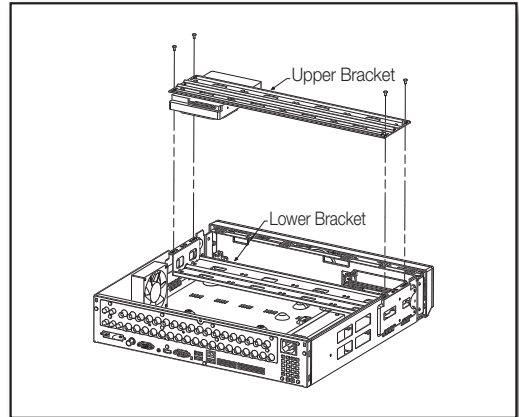

3. Install HDDs (x2) on the lower bracket and fix them with screws.
 - Firmly secure the screw so that it can not get loose from such as vibration.
4. Install HDDs (x3) on the upper bracket and fix them with screws.

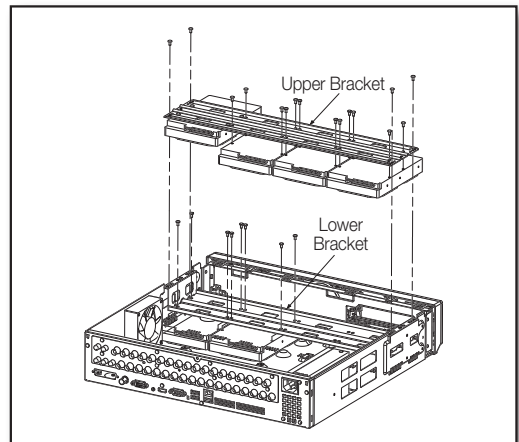

5. When the installation of additional HDDs is done, insert the lower and upper brackets into the DVR and fix them with the provided screws.

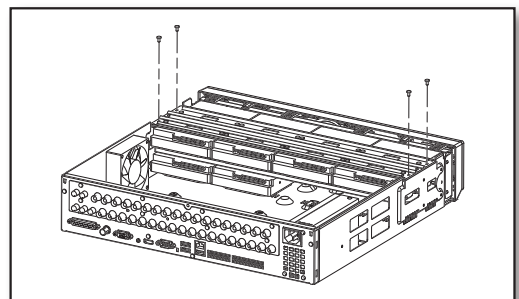

installation

- When the installation of additional HDDs is done, connect the power cable and connect the HDD signal cables (SATA Cable) to connectors ① ~ ⑥ on the main board.
 - You can check the HDD map directly on the DVR. Refer to “**Storage Device > HDD Map**”. (Page 48)
 - Note that the order of the HDD data cable is nothing to do with the operation. Just make arrangements of the connectors considering the length of each connector.
 - SRD-830/1610/1630 do not support DVD media.

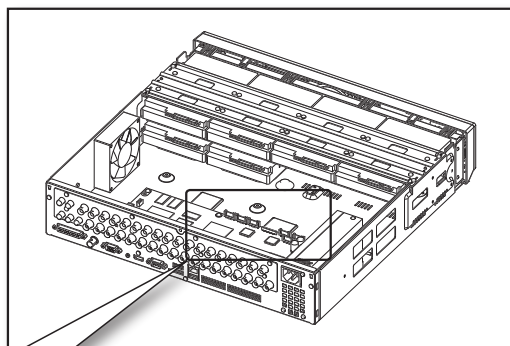
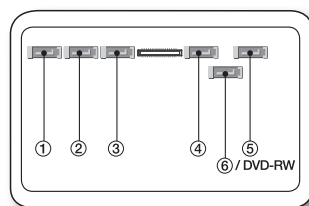

If adding HDDs to SRD-830D/850D/870D/1610D/1630D/1650D/1670D

- First, loosen the screws in the left and right sides and remove the cover.

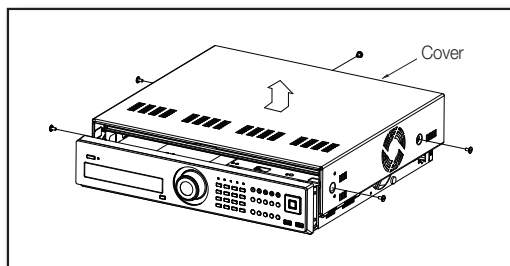

- Loosen the screws (x4) in the left/right and upper sides to remove the upper bracket and loosen the lower screws (x2) to remove the lower bracket.

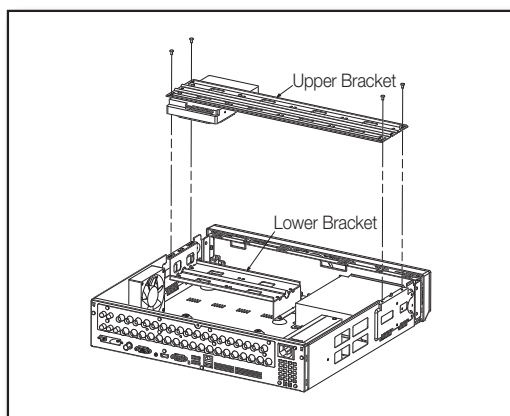

3. Install a HDD (x1) on the lower bracket and fix it with screws.
4. Install HDDs (x3) on the upper bracket and fix them with screws.

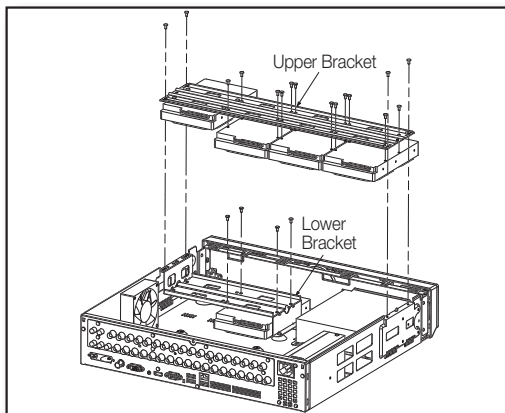

5. When the installation of additional HDDs is done, insert the lower and upper brackets into the DVR and fix them with the provided screws.

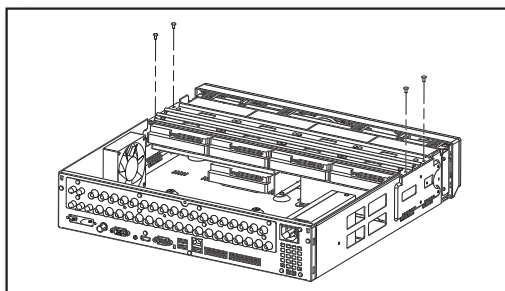

6. When the installation of additional HDDs is done, connect the power cable and connect the HDD data cables (SATA Cable) to connectors ① ~ ⑥ on the main board.
 - Note that the number of a HDD data cable is nothing to do with operation of the HDD. Just make arrangements of the connectors considering the length of each connector.

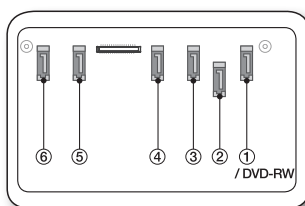
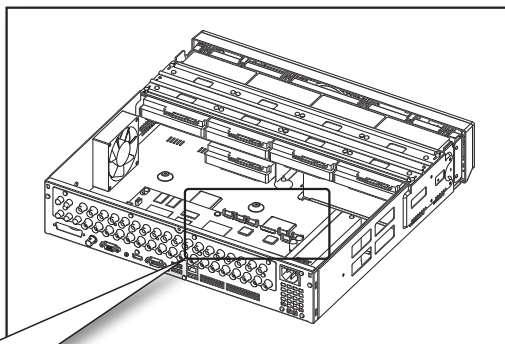

7. Check if the connectors are properly connected and there is no problem with wiring, and close the cover and fix it with screws.

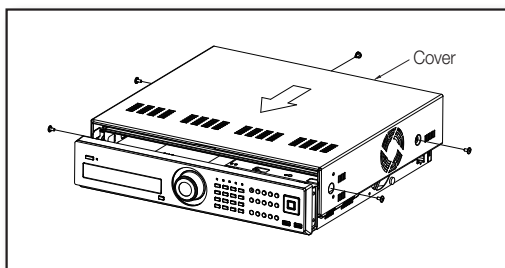

connecting with other device

 The following figures are based on Model SRD-1670D.

CONNECTING THE VIDEO, AUDIO, AND MONITOR

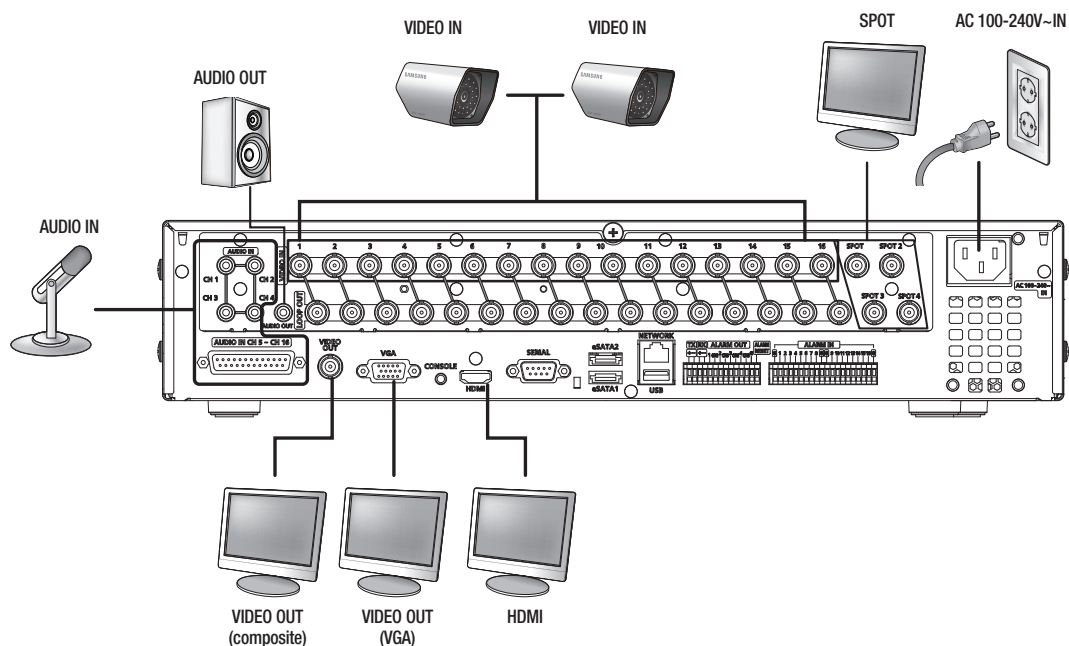

CONNECTING THE USB

1. There are two USB ports at the front and one at the back of the product.
2. You can connect a USB HDD, USB CD/DVD player, USB memory or mouse to the USB port.
3. If a USB HDD is connected to the system, recognition and settings are available in **"Menu > Setting the Device > Storage Device"**. (Page 48)
4. This product supports hot-plugging, which connects/removes the USB device during the system operation.

 If you use the USB device for Backup purposes, format it with FAT32 on PC if it is not formatted on the DVR.

CONNECTING EXTERNAL SATA HDD

- SRD-830/830D/1610/1610D/1630/1630D does not support a port for SATA connection.

1. There are two external SATA ports on the rear side of the product.
2. If an external SATA HDD is connected to the system, recognition and settings are available in “**Menu > Device > Storage Device**”.
3. The DVR supports Hot Plug function to allow connection and disconnection of SATA HDD devices while the system is in use.

- ! Only one SATA HDD can be connected to an external SATA port.
 - Use a cable shorter than 1 m for the external SATA HDD connections.

CONNECTING POS DEVICE

1. You can connect a POS device to the RS-232C port on the product's rear side when you connect it directly with a RS-232C cable.
2. Connection setup for the RS-232C port is available in “**Menu > Device > POS Devices**”, press the <**POS Device Setup**> button and set <**Baudrate, Parity, Data, Stop bit and Transfer Type**>. (Page 51)

CONNECTING THE ALARM INPUT/OUTPUT

The Alarm In/Out port at the back is composed of the following.

1. Alarm In Port for SRD-830/830D/850/850D/870/870D

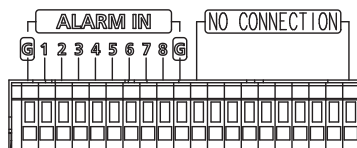

2. Alarm In Port for SRD-1610/1610D/1630/1630D/1650/1650D/1670/1670D

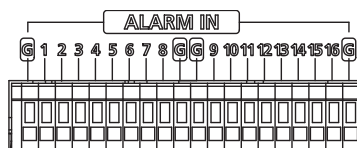

3. Alarm Out Port

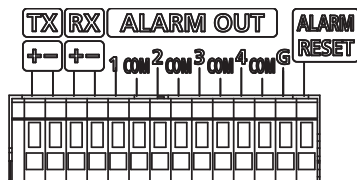

connecting with other device

- ALARM IN 1 ~ 8 (SRD-830/830D/850/850D/870/870D) : Alarm Input Port
- ALARM IN 1 ~ 16 (SRD-1610/1610D/1630/1630D/1650/1650D/1670/1670D) : Alarm Input Port
- ALARM RESET : On receiving an Alarm Reset signal, the system cancels the current Alarm Input and resumes sensing.
- ALARM OUT 1 ~ 4 : Alarm Output Port

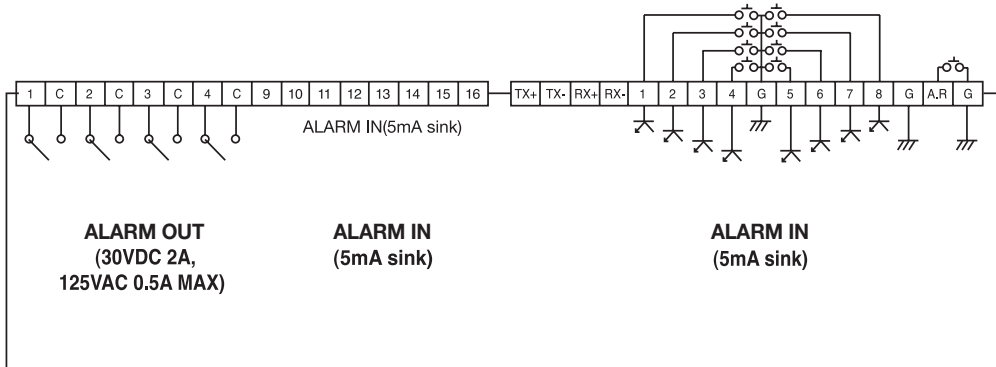

CONNECTING THE RS-485 DEVICE

Connect the RS-485 device through the back port.

- For example, you can connect and control the PTZ camera which supports the RS-485 communication.

- Transfer Type : You may select either Half Duplex or Full Duplex as the data transfer type.
- Baud Rate : Supported Baud rates are 600/1200/2400/4800/9600/19200/38400.

- Check if the RS-485 device is compatible with the product first.
- Pay attention not to change the polarity (+/-) of the RS-485 device when connecting it.
- Depending on camera's type, connection polarity can be different.
For further information, refer to the respective PTZ Camera's documentation.
- Ex : DVR(TX+/-) ↔ SCC-C6433,35(RX+/-)
DVR(TX+/-) ↔ SCC-C6403,07(TX+/-)

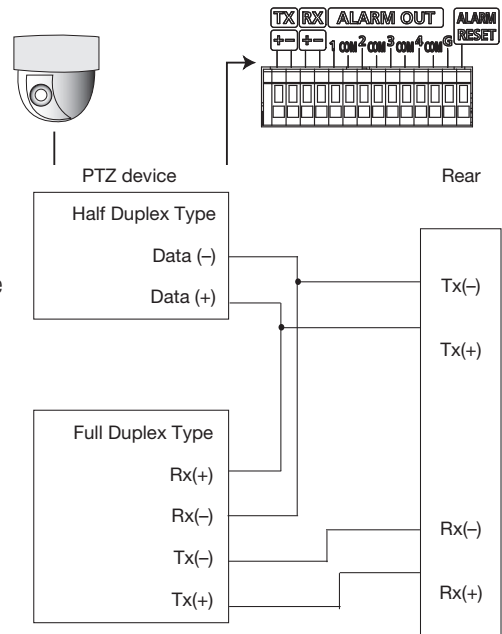

CONNECTING THE NETWORK

Connecting to Internet through Ethernet (10/100/1000BaseT)

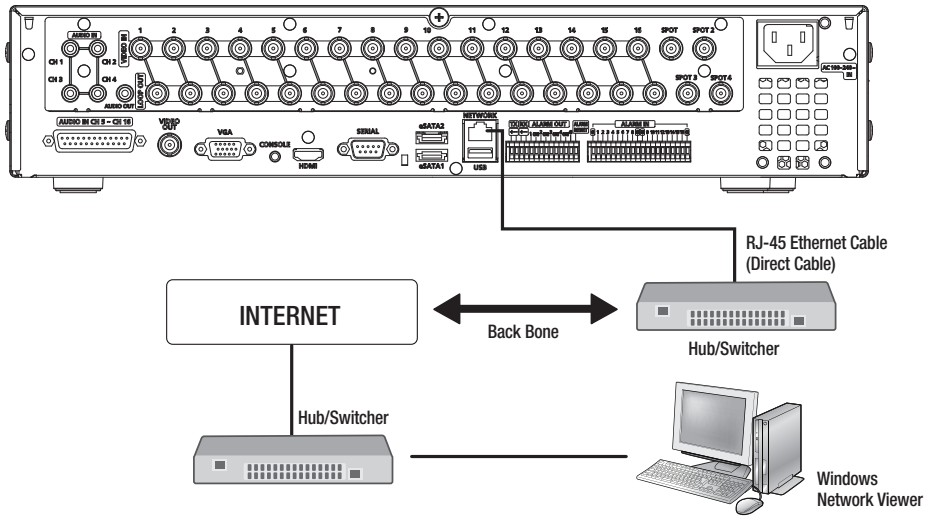

Connecting to the Internet using the router

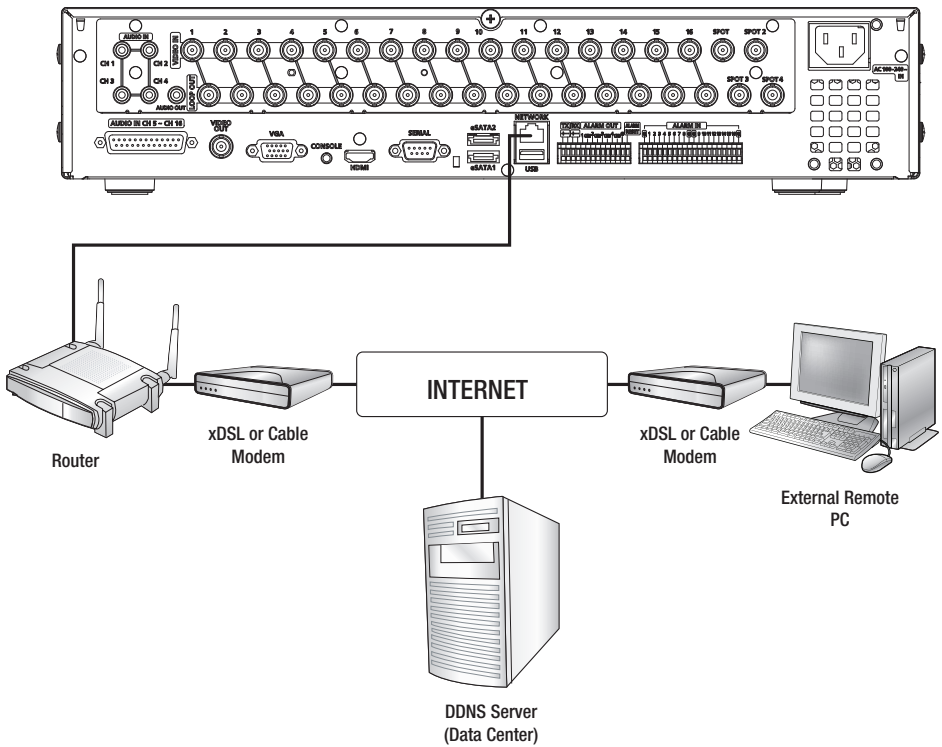

CONNECTING WITH OTHER DEVICE

connecting with other device

Connecting to Internet through ADSL

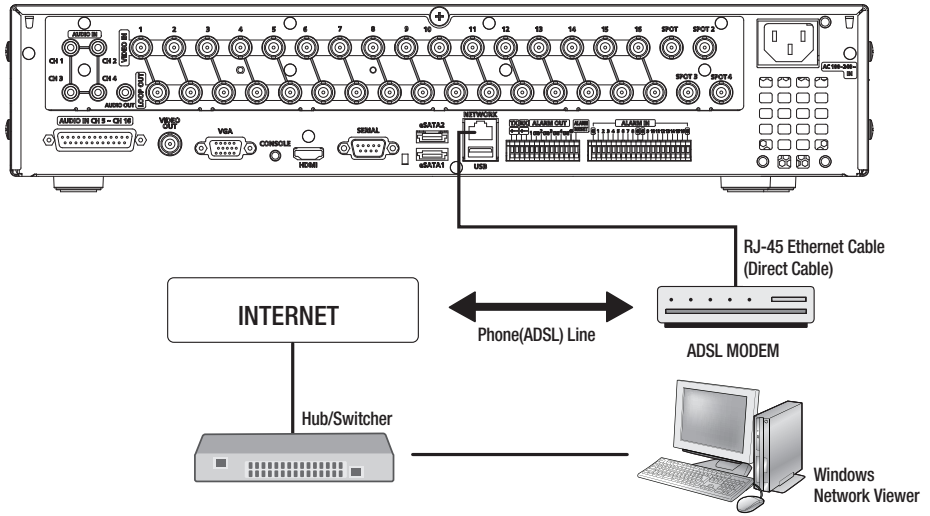

GETTING STARTED

Starting the system

1. Connect the power cable of the DVR to the wall outlet.
2. Press the Power button on the front panel.



3. You will see the initialization screen. The initialization process will last about 1 minute in the order of icons appeared. If a new HDD is installed, the initialization process may take a longer time.

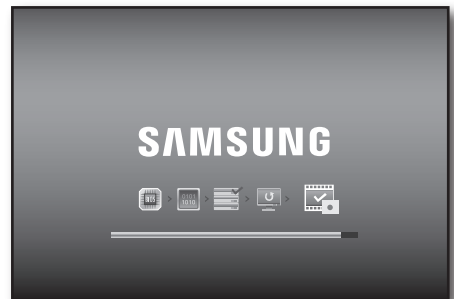

4. The live screen appears with a beep.



Shutting Down the System

You can shut down the system only if you have logged in to the DVR. You should have the <Shutdown> permission to shut down the system if you are not an admin.

1. Press the [POWER] button on the remote control or the front panel, or right-click to display the context sensitive menu and select <Shutdown>.
2. The "Shutdown" confirmation window appears.
3. Use the arrow keys on the remote control or the front panel to move to <OK> and press the [ENTER] button or click <OK>. The system will shut down.



- 
 For the permission management, refer to "Permission Management > Setting Permissions". (Page 41)

Login

To access a DVR or restricted menu, you should have logged in to the DVR.

1. In live mode, right-click any area of the screen.
You will see the context sensitive menu as in the right figure.



2. Click <Login>.
The login dialog appears.
You can also see the login dialog to access a desired menu by pressing the [MENU] button on the remote control or the front panel.
 - The login dialog will also appear if you press a menu button on the remote control or the front panel of the DVR when the corresponding menu requires logging in.

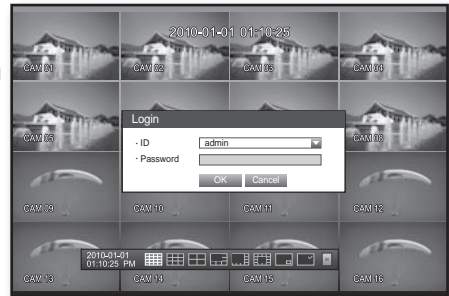

- For the restricted permission, refer to “**Permission Management > Setting Permissions**”. (Page 41)

Locking All Buttons

This will restrict access to all buttons available in the DVR.

1. In Live mode, press buttons in the order of [STOP]→[FREEZE]→[STOP]→[FREEZE]→[MENU].
All buttons will be locked.
2. In the lock condition, press any button to display a dialog where you are prompted to enter the password for unlocking the buttons.
The button lock will be released if you enter the admin password.



LIVE SCREEN CONFIGURATION

Icons on the Live Screen

You can check the status or operation of the DVR with the icons on the live screen.

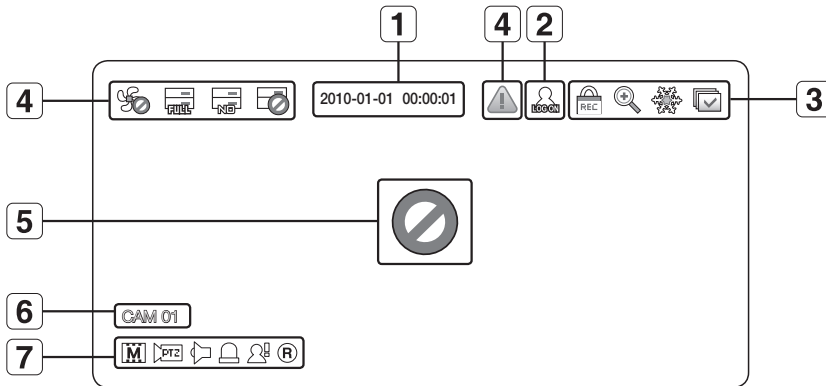

Name	Description
1	Current Date, Time Displays the current time and date.
2	Login Information When you are logged in, the "LOG ON" icon will be displayed.
3	Displayed if the zoom function is activated.
	Displayed if you press the Pause button.
	Displayed in Auto Sequence mode where all channels are switched at the specific time interval.
	Displayed if the recording is in process. To cancel the recording, enter the password.
4	Displayed if there is a problem with the cooling fan.
	Displayed if the HDD is full and the DVR has an insufficient space to record.
	Displayed if no HDD is installed or the existing HDD should be replaced.
	Displayed if the HDD needs a technical examination.
	Displayed if a new firmware is found from the network.
5	Displayed if no input is entered in the condition that the camera is set to <ON>. Nothing will be displayed on the screen if the camera is set to <OFF>.
	Camera Name/ Channel Displays the camera name and the changed channel, if any.
7	Displays the resolution of the recording screen. (Page 56)
	Displayed in PTZ setting, and highlighted yellow if PTZ is in operation.
	Displays AUDIO ON/MUTE. Not displayed in video mode if deactivated.
	If the sensor is set to <ON>, the input signal will be displayed on the screen of the connected channel.
	Displayed if a motion detected in the condition that the motion detection is set to <ON>.
	Displays the current record mode from Record/Event/Schedule.

Error Information

- If you turn on the system in the condition that the internal HDD is not connected or an error occurs, the “HDD FAIL” icon (HDD) will be displayed on the top left corner. In this case, make sure you contact the service center for assistance as this may cause a failure of recording, playback or backup.
- If the cooling fan does not work properly or has a problem, the <Fan Information> window will appear and the fan error icon (FAN) will be displayed on the top left corner. In this case, check the internal fan for operations.
As a fan error can shorten the product life, make sure you contact the service center for assistance.



- If you see the fan error icon or No HDD, HDD FAIL icons on the screen, contact the service center for more details.

Live Screen Menu

In addition to the buttons on the front panel or the remote control, you can access a desired menu by right-clicking any area in live mode.

The context sensitive menu appearing by right-clicking the screen differs, depending on the login/logout, screen split mode and DVD operation mode.



- Menu items of Search, Record, Backup, Shutdown and PTZ can be deactivated, depending on the user permission.



< Split Mode Menu >



< Single Mode Menu >

Split Mode Menu

The context sensitive menu in split mode differs, depending on the login/logout status.

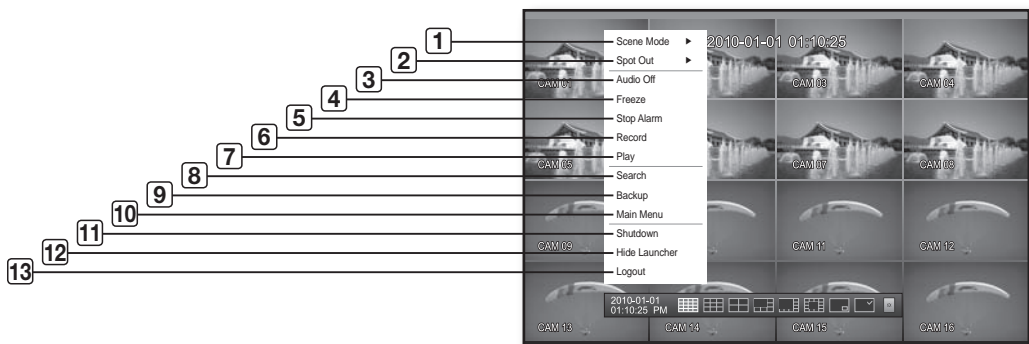

Menu	Description
1 Scene Mode	Refer to "Live Mode" . (Page 31)
2 Spot Out	Refer to "Spot Out" . (Page 33)
3 Audio On/Off	Refer to "Audio ON/OFF" . (Page 34)
4 Freeze	Refer to "Freeze" . (Page 34)
5 Stop Alarm	Stops the alarm output and the event monitoring. Refer to "Event Monitoring" . (Page 35)
6 Record/Stop	Starts/stops the standard recording.
7 Play	Plays the search result (data). Refer to "Search & Play > Play" . (Page 73)
8 Search	Refer to "Search & Play > Search" . (Page 70)
9 Backup	Refer to "Using the DVR > Setting the Backup" . (Page 60)
10 Main Menu	Accesses the main menu. Refer to the Using the DVR section. (Page 36)
11 Shutdown	Turns down the DVR.
12 Show/Hide Launcher	Shows or hides the launcher. Refer to "View the Launcher Menu" . (Page 30)
13 Login/Logout	You can log in or out.

Single Mode Menu

The single mode menu is available only in the Single mode.

The context sensitive menu of the One Channel mode in Split mode is different from that of the Single mode.



Menu	Description
1 Full Screen	Select and click a desired channel in Split mode to switch to the full screen of the selected channel.
2 PTZ Control	Accesses the PTZ Control menu. The PTZ menu is activated only in One-Channel Live mode. (Page 68)
3 ZOOM	Enlarges the selected image. (Page 34)

View the Launcher Menu

You can use the Launcher menu appearing on the bottom of the live screen to access it.

1. In Live mode, right-click to display the context menu and select <Show Launcher>.
2. Move the cursor to the bottom and click a desired item in the Launcher menu.



- If no input is entered for 10 seconds, the menu will disappear.
- The Launcher menu can be accessed only using the mouse.
- SRD-830/830D/850/850D/870/870D do not support the 16-split screen mode.



Menu		Description
1	Date/Time	Displays the current time and date. The indication of AM/PM is displayed if you set 12 hours for the time format in "System > Date/Time/Language > Time". (Page 36)
2	Screen Mode	Displays in the sequence of 16-, 9-, 4-, 6-, 8-, 13-split, PIP and Auto Sequence. The current mode is highlighted in white.
3	Menu Expansion Button	Click to display the hidden menu to the right.
4	Audio	Turns ON/OFF the sound of the selected channel.
5	Zoom	Enlarges the selected area. This is available only in Single Live mode.
6	PTZ	Runs the PTZ Control launcher. This is available only in Single Live mode.
7	Alarm	Stops the alarm if it's activated.
8	Freeze	Freezes the Live screen temporarily.
9	Play	Enters Play mode if a file to play exist, and if not, enters Search mode.
10	Record	Start/End recording the Live screen.

LIVE MODE

SRD-1610/1610D/1630/1630D/1650/1650D/1670/1670D display Live images from 16 channels in a total of 8 layout of split screens.

Switching the screen mode

To switch the split mode, select a screen mode in the launcher menu, or right-click to select a screen mode in the context menu.

Press the **[MODE]** button on the front panel or the remote control to switch the mode in the sequence of the launcher menu items.



- SRD-830/830D/850/850D/870/870D do not support the 16-split screen mode.

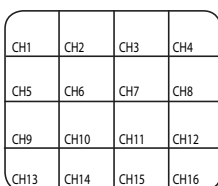

16-split mode

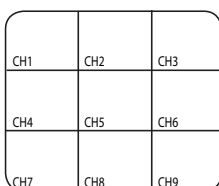

9-split mode

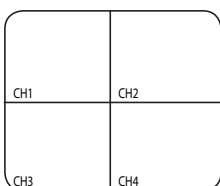

4-split mode

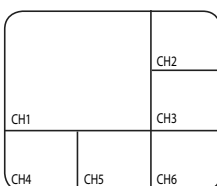

6-split mode

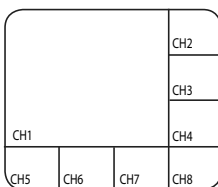

8-split mode

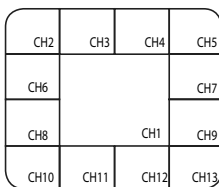

13-split mode

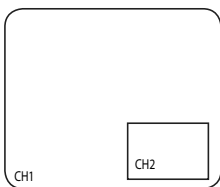

PIP

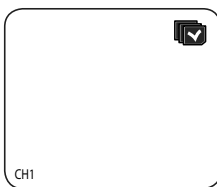

Auto Sequence

Switching the split mode

SRD-1610/1610D/1630/1630D/1650/1650D/1670/1670D display 16 Live images in the sequence of Single, 4-split and 9-split modes.

Auto Sequence

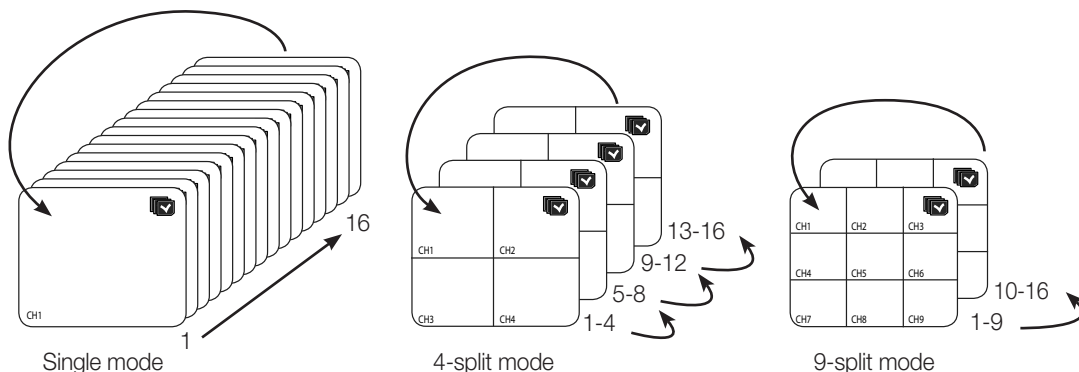

- In Single mode, If you have set **<SEQ-Dwell Time>** in “**Setting the Device > Camera**”, Auto Sequence will be conducted at the set interval. (Page 46)
- In a split mode, If you have set **<Multi CH SEQ Time>** in “**Setting the Device > Monitor**”, Auto Sequence will be conducted at the set interval. (Page 52)

Manual Switching

Press the left/right button on the front panel or the remote control, or click the arrow <◀/▶> key to move to the next split mode.

- If pressing the right [▶] button in 9-split mode :
9-split (CH 1~9) mode → 9-split (CH 10~16) mode → Auto Sequence

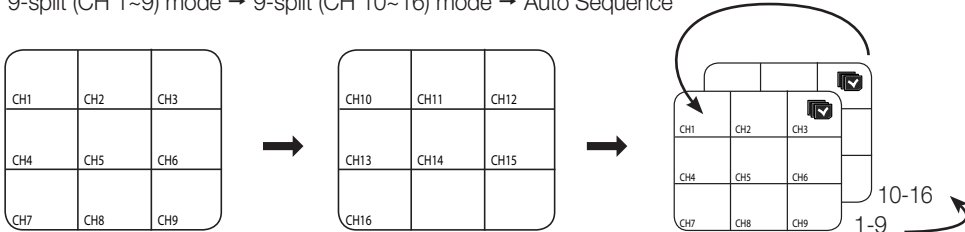

- If pressing the right [▶] button in 4-split mode :
Channel (CH 1~4) → Channel (CH 5~8) → Channel (CH 9~12) → Channel (CH 13~16) → Auto Sequence

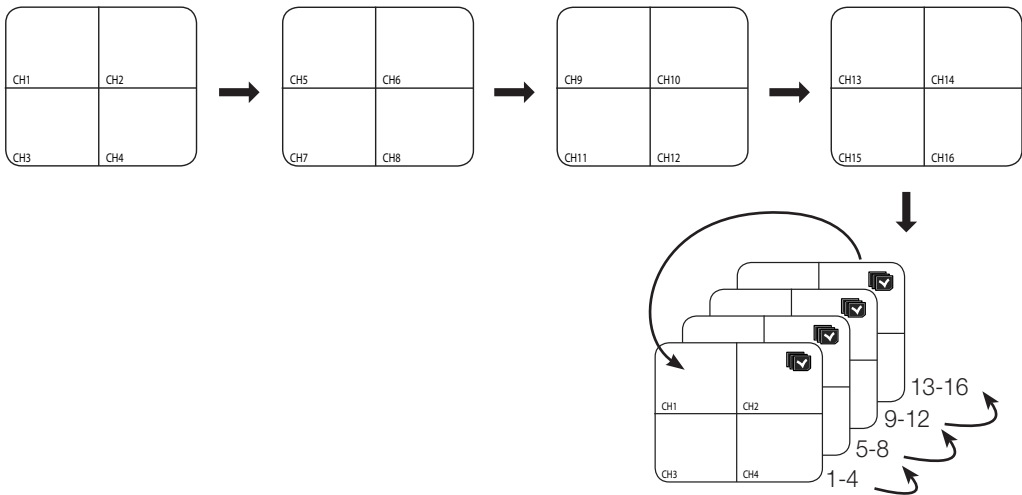

Channel Setting

You can display the channel in a desired area of a split screen.

1. Place the cursor over the camera name of each channel to display the <▼> key to the right on the screen.
2. Click a camera name to display a channel list where you can select a different channel.
3. Select a desired channel and click it.

The current channel will be switched to the selected one.

Use the cursor to select a channel to move, and drag and drop it to a desired channel; this can also change the channel position.

- Ex : if switching CH 1 to CH 7

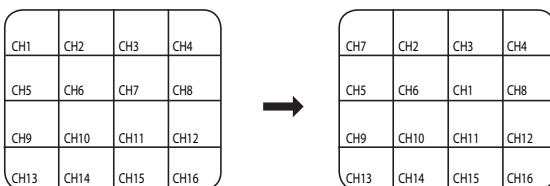

Switching to Single Mode

In a split mode, select and double-click a desired channel to switch to its Single mode.

Press the number corresponding to a desired channel on the front panel or the remote control to switch to its Single mode.

Refer to “**Remote Control > Using the numeric buttons**”. (Page 13)

- Ex : If double-clicking CH 3 or pressing the number “3” on the remote control or the front panel.

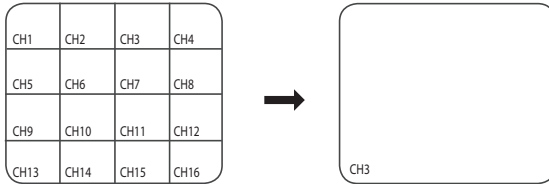

SPOT OUT

The Spot Out monitoring is independent of the Live mode, which monitors a specific channel through the Spot Out port.

Selecting a Spot Out mode

If an event occurs such as sensor, motion or alarm from the Spot Out port in connection with a monitor, you can select a output screen mode.

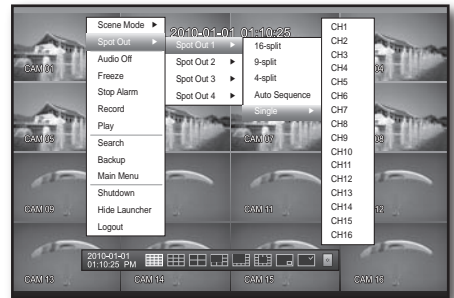

1. In Live mode, right-click any area on the screen.
The Live menu appears.
2. Click Spot Out.
The split screen appears according to the Spot Out source. (Page 53)
 - Spot Out 1 : Supports 16-, 9-, 4-split, Auto Sequence and Single modes.
 - Spot Out 2, 3, 4 : Supports 4-split, Auto Sequence and Single modes.
 - The number of Spot Out terminals differs according to the model. For the Spot Out port of a model, refer to “**Part Names and Functions (Rear)**”. (Page 10)



< Multichannel Live Menu >

ZOOM

This is available only in Single Live mode. In Single mode, select a desired area and use the Zoom function to enlarge it twice.

1. Select <ZOOM> in the right-click menu.
Press the [ZOOM] button on the front panel or the remote control, or simply click <  > in the launcher menu. The zoom box appears.
2. Use the direction keys, or drag and drop to specify an area to enlarge.
3. Press the [ENTER] button, or double-click the selected area to enlarge it twice.
 - In the enlarged image, use the direction buttons (▲▼◀▶) on the remote control or the front panel to move the enlarged area.
4. Press the [ZOOM] button on the front panel or the remote control, or simply click <  > in the launcher menu to release the zoom.



AUDIO ON/OFF

You can turn the sound on/off corresponding to the channel in Live mode.



AUDIO ON/OFF in Single mode

Click the audio icon (🔊) on the screen, or press the [AUDIO] button on the front panel or the remote control to turn it on/off.

- Only the channel where <AUDIO> is set to <ON> in “Device > Camera” displays the audio icon (🔊) in Live mode that you can use to turn the sound on/off.

FREEZE

This is available only in Live mode that stops playing the Live image temporarily.

1. Press the [FREEZE] button on the front panel or the remote control, or click <  > in the launcher menu.
The playback of the image is stopped temporarily.
2. Press the [FREEZE] button again, or click <  >.
This will release the freeze.

EVENT MONITORING

This will display the channel in sync with a specific event (Sensor/Motion/Video Loss) if it occurs.

In "**Monitor > Event Display**", set the event monitoring to ON/OFF and specify the event display time. (Page 52)

- If multiple events occur simultaneously, the screen will switch to a split mode.
 - 2~4 events : 4-split mode
 - 5~9 events : 9-split mode
 - 10~16 events : 16-split mode
- If the second event occurs within the set time of <Event Display>, the first event will last until the second one is terminated. (Page 52)
 - Ex : If you set <Event Display> to 5 seconds, and only one event occurs in CH 1.

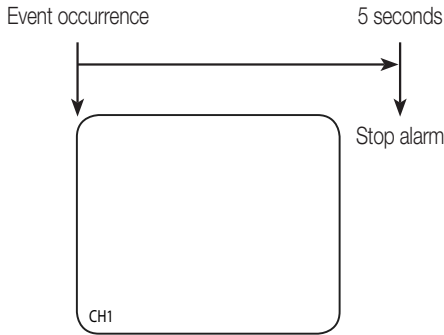

- Ex : If you set <Event Display> to 5 seconds, and the second event occurs in CH 2 within the set time after the first event occurred in CH 1.

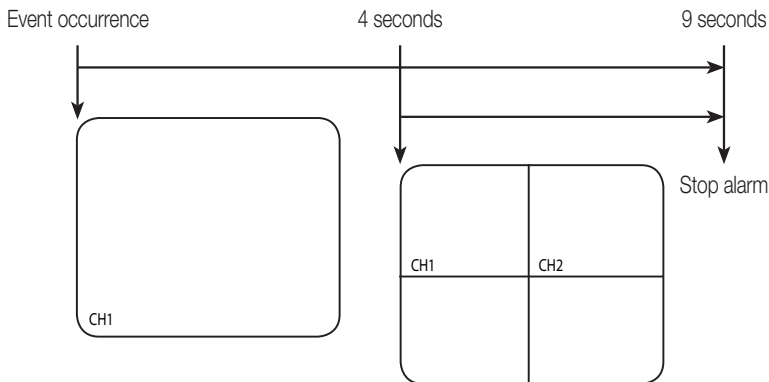

- 
 - Press the [**ALARM**] button to reset the alarm settings and to release the event mode.
 - If an alarm activates in the condition you have set the event record, and pre/post alarm times, the event record will be performed.
 - This will also apply to the Spot Out monitor.

using the DVR

You can setup the system properties, devices, and options for recording, event, backup and network.

SYSTEM SETUP

You can setup Date/Time/Language, Permission, System Properties and Log.

Date/Time/Language

You can check and setup the current Date/Time and time related properties, as well as the language used for the interface on the screen.

Setting the Date/Time/Language

Set the Date/Time/Language

Using the mouse may help easy setup.

1. Press the **[MENU]** button on the remote control or on the front panel.

- If not logged in, it prompts with login window.
Refer to "Login". (Page 26)



2. Use the left/right buttons (◀ ▶) to select the <System>. System property setup menu is selected.
3. Use the up/down buttons (▲ ▼) to select <Date/Time/Language> and press the **[ENTER]** button.
4. Select <Date/Time/Language>.
A dialog to setup Date, Time and Language.
5. Use direction buttons (▲ ▼ ◀ ▶) to select an item to set and make your changes.



- Date : Sets the date appears on the screen.
You can select the date format.
- Time : Sets the time and its format appear on the screen.
Select either one from <24 Hours, 12 Hours (AM/PM)>.
- Time Zone : Sets the time zone of your area based on the Greenwich Mean Time (GMT).
 - GMT (Greenwich Mean Time) is standard World Time and the basis of world time zone.
- Time Sync. : You can set the DVR's current time synchronized to a selected <Time Server> regularly if you select to use <Time Server>.

In this case, <Date/Time/Language> setup does not allow time adjustment.

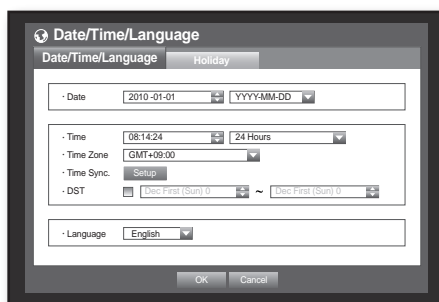

- Time Server : Enter an IP or URL address of the time server.
 - Last Sync Time : Displays the most recent synchronization time from the selected time server.
 - Activate as Server : Set to <Use> to allow the DVR to act as a Time Server for other DVRs.
 - DST : Set up Daylight Saving Time with its period to make the time earlier than the GMT of its time zone by 1 hour during the set period.
 - Language : Select your language. Sets the language for the interface.
English, French, German, Spanish, Italian, Chinese, Russian, Korean, Polish, Japanese, Dutch, Portuguese, Turkish, Czech, Danish, and Swedish are available.
6. When the Date/Time/Language setup is done, press <OK>.

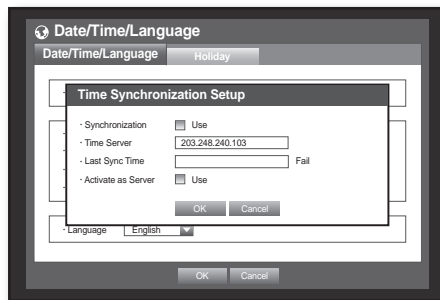

- You can also use numeric buttons on the remote control or front panel to enter values for Date, Time and other numeric fields.

Setting Holiday

You can set specific dates to Holidays according to your preferences. Holidays are applied to <Recording Schedule> and <Alarm Schedule> too.

Using the mouse may help easy setup.

3. Use the up/down buttons (▲▼) in <Date/Time/Language> window to select <Date/Time/Language>, and press the [ENTER] button.
4. Select <Holiday>.
A calendar for Holiday setup appears.
5. Use the left/right <◀ ▶> buttons to select year or month, and press the [ENTER] button.

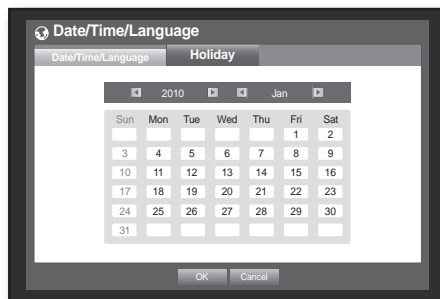

6. Use direction buttons (▲▼◀▶) to select a desired date, and press the [ENTER] button.
You will see the "Setting Holiday" screen.
 - Ex : Select January 11th and check on <1/11> only to make every January 11th a holiday. Check both on <1/11> and <Jan 2nd Mon> to make every January 11th and 2nd Monday of January holidays.
7. When the Holiday setup is done, press <OK>.

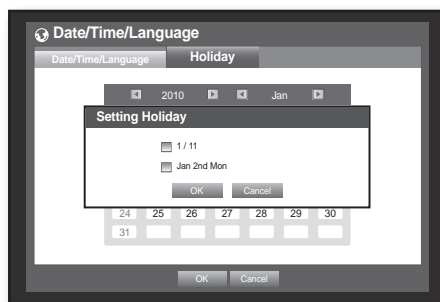

Using the Calendar

Using the mouse may help easy setup.

- ① Select year and month.
Select the left/right <◀ ▶> key on the left/right side of year/month and press [ENTER] button to adjust by 1 year/month.
- ② Use direction buttons to select a date and press [ENTER] button.
 - A date with recorded data to be searched will be appeared in yellow in the System Log, Event Log, Time Search and Event Search.

using the DVR

Permission Management

You can set permissions of each user over the DVR's specific function and settings.

Setting the Administrator

You can set and change Administrator's ID and password.
The administrator can use and set all menu items and functions.

Using the mouse may help easy setup.

3. Use the up/down buttons (▲▼) in <System> window to move to <Permission Management>, and press [ENTER] button.

4. Select <Admin>.
A dialog for Admin ID and Password input appears.

5. Use direction buttons (▲▼◀▶) to move to a desired item, and set the ID and password.



- By default, initial ID and password are set to "admin", and "4321".

6. When the administrator setup is done, press <OK>.

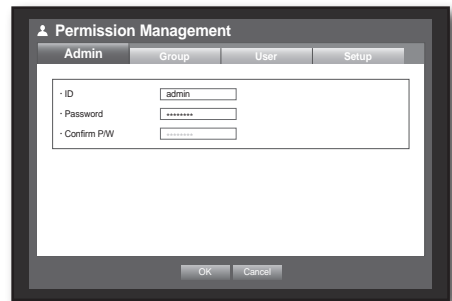

Using Virtual Keyboard

- ① For alphanumeric inputs, the virtual keyboard window appears.
- ② Use direction buttons (▲▼◀▶) to move to a desired character, and press the [ENTER] button.
- ③ In the upper text input box of the virtual keyboard, there displays a list of candidate words containing the selected character.
- ④ Select a word from the list, or use the keyboard to enter the whole word.

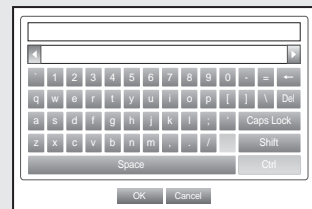

- If there are many of candidate words, use <◀, ▶> buttons to move between them forward and backward.
 - You can use mouse wheel and jog shuttle button too.
- ⑤ Select <OK>.
Entered word is applied.
 - For upper case letters, use <Caps Lock> button.
 - For special characters, use <Shift> button.
 - Using the virtual keyboard is the same to a normal keyboard use in your region.
 - You can enter only lower-case alphabets and numeric values for the user ID.
 - For the password, use alphabets and special characters excluding <\> and <“>.
 - You can use number buttons on the remote control or front panel.

Setting the Group

You can create a user group, and setup permissions of a user group.

You can register a user for each group in <User>.

Using the mouse may help easy setup.

- Use the up/down buttons (▲▼) in <System> window to move to <Permission Management>, and press [ENTER] button.

- Select <Group>.

A window for <Add>, <Delete>, <Rename>, and <Group Authority> setup appears.

- Use direction buttons (▲▼◀▶) to move to a desired item, and set the value.

- Add, Delete, Rename : You can add, delete, rename a group or modify the permissions given to the group. The virtual keyboard appears when <Add> or <Rename> was selected. You can add up to 10 groups.

- Add : When you first run the DVR with the admin account, there exists no account but the admin so all buttons except for Add has already been deactivated. Select <Add> to display the virtual keyboard. Enter a group name. You can add up to 10 groups.

- Delete : Deletes a user group that is already registered. Selecting Delete will delete all user accounts belonging to that group.

- Rename : Renames a group that is already registered. Select <Rename> to display the virtual keyboard.

- For entering a group name, refer to "Using Virtual Keyboard". (Page 38)

- Group Authority : Sets permissions to access menu items of each group. Users of a group can access checked functions.

- When the group setup is done, press <OK>.

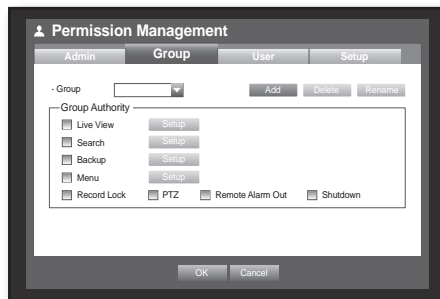

To set the group authority

You can set the permissions of the group users to access the menu according to the channel.

- Select a menu to which the group permission is assigned. The menu where the group permission is assigned will be displayed in the Live menu when a group user logs in.

- Live View : You can set the permission to access the Live screen according to the channel.
- Search : You can set the permission to access the Search menu according to the channel.
- Backup : You can set the permission to access the Backup menu according to the channel.
- Menu : You can set menus accessible with a specific permission. Group users can access the permitted menus only. Select a menu to display the Menu Permission screen.
- Record Lock, PTZ, Remote Alarm Out, Shutdown : Select an item so that the item will be added to the permissions.

- Select <OK>.

Select and assign a group user so that the user can access the specified menu.

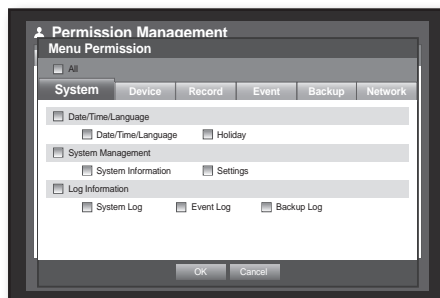
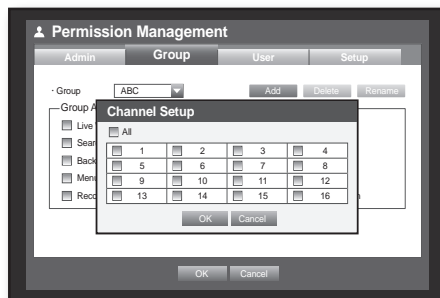

using the DVR

To restrict the user permissions

If the admin restricts all permissions of an added group, the users belonging to that group can access only the default minimum menus and can change the user's own password only.

1. Start the DVR.
If all permissions are restricted, only the Login dialog should appear.
2. Log in with a registered user ID.

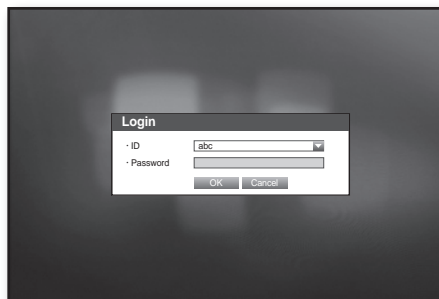

3. Right-click any area on the screen.
If all permissions are restricted, only the accessible context menu should appear.

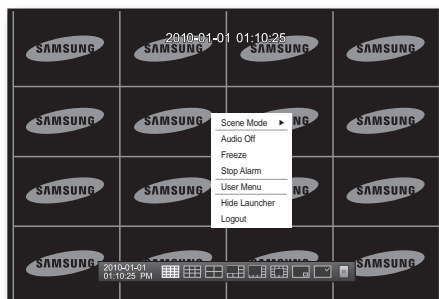

To change the user password

If you log in with a user account that is restricted to access the menu, you can change your own password only.

1. Log in with your account.
2. Select <User Menu>.
The Permission Management setup screen appears.
3. Select <Permission Management>.
The Password setup dialog appears.
4. Enter a new password.
5. Select <OK>.
Your change to the password will be applied.

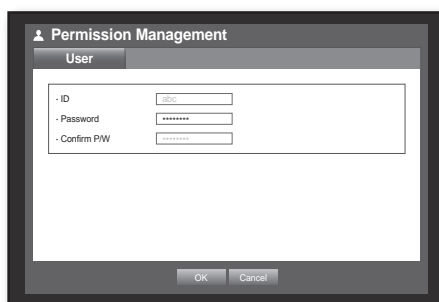

Setting the User

Users can be added only if a group was created in <Group> menu.

Using the mouse may help easy setup.

3. Use the up/down buttons (▲▼) in <System> window to move to <Permission Management>, and press [ENTER] button.
4. Select <User>.

A window for Add User appears.
5. Use direction buttons (▲▼◀▶) to select <Add> from the window.

A window for "Add User" appears.

You can configure the Network Viewer settings including name, ID, viewer, Select Group and password.

Result of the user setup appears in the <User> window.

To change the user property, use "Edit User".

The "Edit User" window appears when you select a desired item to be changed in the <User> window.
- Viewer : If you select <Use>, you will be given access to the Web Viewer and Network Viewer.
 - Refer to "Connecting Web Viewer". (Page 75)
 - For more information about use of Network Viewer, refer to the Network Viewer's user guide. (Page 5)
6. When the user setup is done, press <OK>.

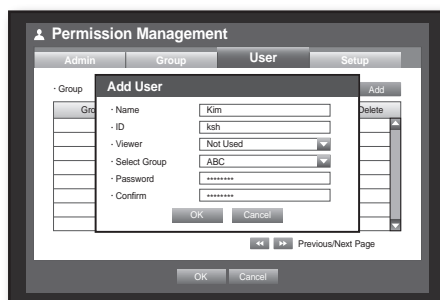
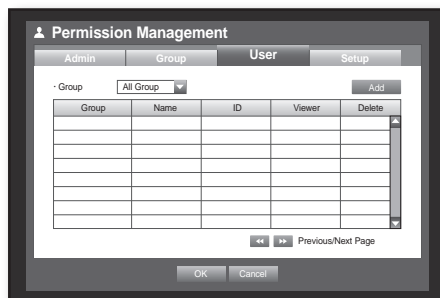

Setting Permissions

You can set restricted access for all general users.

Items with restrictions will require logging in for use.

Using the mouse may help easy setup.

3. Use the up/down buttons (▲▼) in <System> window to move to <Permission Management>, and press [ENTER] button.
4. Select <Setup>.

The Restricted Access, Restriction on Network Access, Auto Log out, Manual Input of ID setup screen appear.
5. Use direction buttons (▲▼◀▶) to move to a desired item, and set the value.
- Restricted Access : All menu items allowed for a user can be set with restricted access.
 - Checked (☑) : Restricted
 - Not checked (☐) : Accessible
 - If it is not checked (☐) in <Restricted Access>, any user can access the item no matter what the <Group Authority> setting.
 - If it is checked (☑) in <Restricted Access>, a user can access the item only if the user has permission in <Group Authority> setting.
- Restriction on Network Access : Restricts remote access from a <Restricted Access> network.
 - All Network : Restricts all access instances via Network Viewer and Web Viewer.
 - Web Viewer : Restricts access via the Web Viewer.
- Auto Log out : A user will be automatically logged out if there is no operation on DVR for over set period of time.

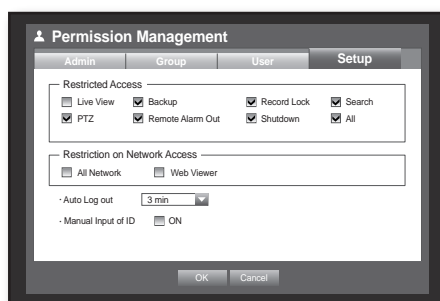

using the DVR

- Manual Input of ID : Prompts you to enter the user ID manually for the login process.
 - Checked () : Encloses the registered user IDs with the [*] symbols.
- Use the virtual keyboard to enter the user ID.
6. When the permission setup is done, press <OK>.

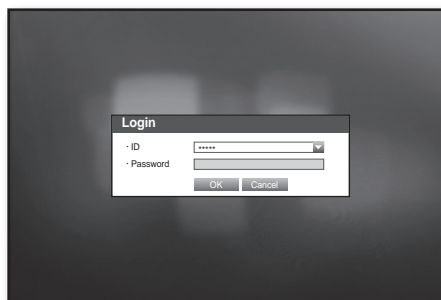

System Management

You can check the system version, update to a newer version, as well as data backup and initialization.

Checking the System Information

You can check the current system version, broadcasting system, MAC address. You can update the system. Using the mouse may help easy setup.

3. Use the up/down buttons (▲▼) in <System> window to move to <System Management>, and press [ENTER] button.
 4. Check the Version, Broadcast Format, and MAC Address.
- System Information : Shows the current system's information.
The values can not be changed by a user.
 - S/W Upgrade : Updates the DVR's software up to date.

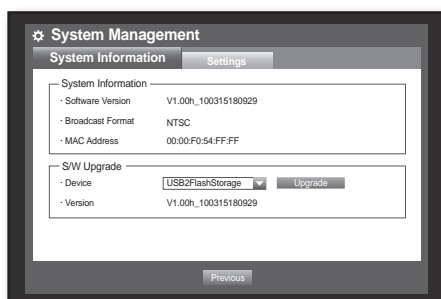

• **Updating the Software**

1. Connect a device storing the software to be updated. (It may take about 10 seconds to recognize the device.)
 - Upgradeable devices include USB memory, CD/DVD and network device.
 - To update the network, the current DVR should have been connected to the network. Upgrade via the proxy server may not be enabled due to the restricted access.

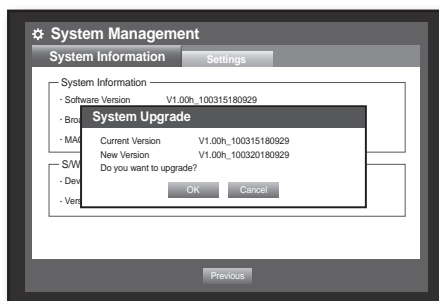

2. Select <System Management> from <System> window.
3. Select <System Information>.
4. When the recognized device appears, select <Upgrade>.
 - The <Upgrade> button will be activated only if the current <Software Version> of the <System Information> is same to or older than that of <S/W Upgrade>.
5. Press <OK> in the “System Upgrade” window.
 - While updating, it shows the progress.

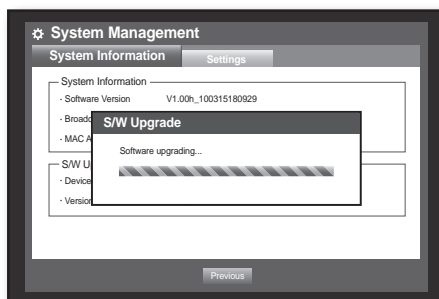

- Updating progresses with 3 steps as shown in the figure.

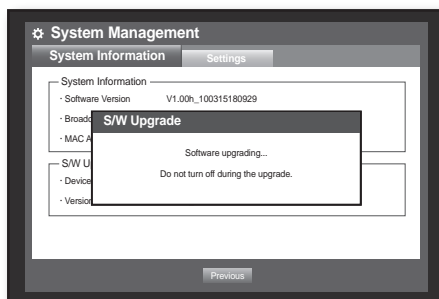

6. When the updating is done, it automatically restarts. Do not turn the power off until it finishes restarting.



- If “Upgrade Failed” appears, retry from the step 4. When you experience continued failure, consult the service center for assistance.



using the DVR

Settings

You can copy and import the DVR settings by using a storage media.

Using the mouse may help easy setup.

3. Use the up/down buttons (▲▼) in <System> window to move to <System Management>, and press [ENTER] button.

4. Select <Settings>.

A window of storage device and load factory default appears.

5. Use direction buttons (▲▼◀▶) to move to a desired item, and export or import settings data to a storage device.

- Storage Device : Shows the connected storage device.
- Export : Exports DVR settings to the connected storage device.
- Import : Imports DVR settings from the storage device and applies to the DVR.
 - If <Include Network Settings> is checked, the network settings will be imported too.

• Load Factory Default : If <Default> is selected, a confirmation dialog for “Load Factory Default” prompts. Press <OK> to initialize the system to the factory default.

6. To move to the previous menu, press <Previous>.

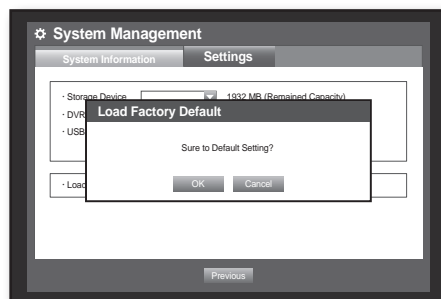
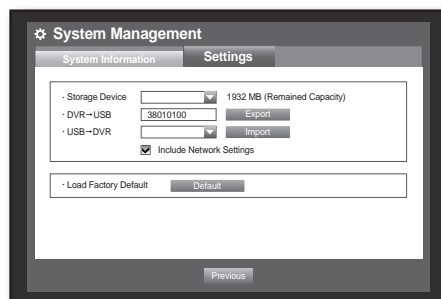

Log Information

You can browse logs on the system and events.

System Log

System Log shows log and timestamp on every system start up, system shutdown, and changes on system settings.

Using the mouse may help easy setup.

3. Use the up/down buttons (▲▼) in <System> window to move to <Log Information>, and press [ENTER] button.

4. Select <System Log>.

- Refer to “Using the Calendar”. (Page 37)
Click on the calendar <[Calendar Icon]> to display the calendar window.

• Type : When there are too many logs, you can display logs of the desired format by selecting the type.

5. Use direction buttons (▲▼◀▶) to move to a desired item, and press <Search>.

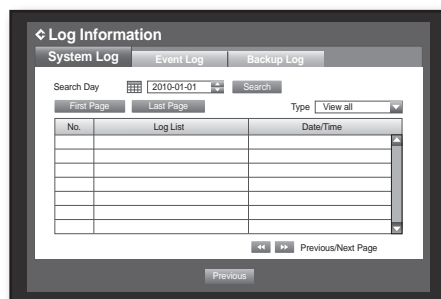

Event Log

Event log shows recorded events on alarms, motion detections and video loss. It also shows the log and its timestamp.

Using the mouse may help easy setup.

3. Use the up/down buttons (▲▼) in <System> window to move to <Log Information>, and press [ENTER] button.
4. Select <Event Log>.
5. Use direction buttons (▲▼◀▶) to move to the desired item.
6. Set Search Day, Channel and Type and the press <Search>.
 - Refer to "Using the Calendar". (Page 37)
Click on the calendar <📅> to display the calendar window.

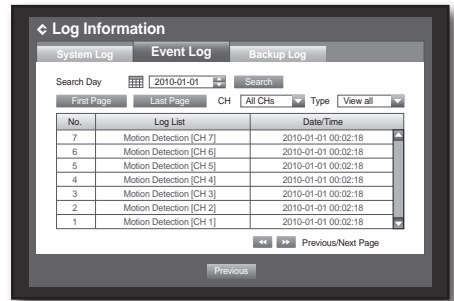

Backup Log

You can find out who backed up and the details (backup time, channel, device to use, file format, etc.).

Using the mouse may help easy setup.

3. In the <System> window, press the up/down (▲▼) button to move to <Log Information> and press the [ENTER] button.
4. Select <Backup Log>.
5. Use the four direction buttons (▲▼◀▶) to move to a desired item.
6. Specify a search term and select <Search> in the right corner. Backup details for the search term will be listed.

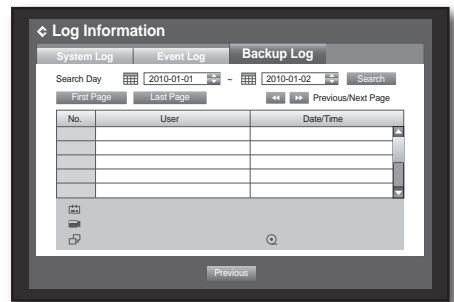

using the DVR

SETTING THE DEVICE

You can setup Camera, Storage Device, Remote Device, POS Device and Monitor.

Camera

Setting the Camera

You can set Video, Audio, Channel Name and Dwell Time of a Camera.

Using the mouse may help easy setup.

1. Press the [MENU] button on the remote control or front panel.
2. Use the left/right button (◀ ▶) to select <Device>. Device setting menu is selected.
3. Use the up/down buttons (▲ ▼) to move to <Camera>, and press [ENTER] button.



4. Select <Camera>. You will see a window where you can configure the camera settings including Video, Audio, Channel Name, Dwell Time and Progressive.
5. Use direction buttons (▲ ▼ ◀ ▶) to move to a desired item, and set the value.

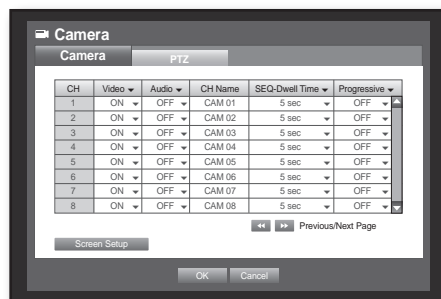

- Video
 - <ON/OFF> : You can turn ON/OFF the selected channel's camera.
 - <Covert1> : Shows information other than the video of the selected channel.
 - For privacy protection, it does not display the video while the recording continues.
 - <Covert2> : Shows nothing but an empty screen while the recording continues.
 - Audio
 - If set to <ON>, you can turn the audio of the channel ON/OFF on the Live screen.
 - If set to <OFF>, the channel's audio is off on the Live screen and not recorded.
 - Audio output is available for only 1 channel.
-  SRD-830/830D/1610/1610D/1630/1630D supports 1~4 channels of sound inputs.
- CH Name : Up to 15 characters including blanks are allowed.
 - Refer to "Using Virtual Keyboard". (Page 38)
 - SEQ-Dwell Time : You can set the dwell time between channels for the Live screen and Spot Out.
 - If set to <OFF>, the channel is not listed in the Auto Sequence mode.

- Progressive : You can set the progressive camera to ON/OFF.



▪ If you set it to <ON> for the progressive camera, screen flickering will be reduced.

- Screen Setup : The video appeared on the screen may vary depending on the channel's camera, configure the DVR display to your preferences. Select a channel and adjust the <☀️ (Brightness)>, <🎚️ (Contrast)>, and <🎨 (Color)> of the selected channel.
 - Press the <Init> to initialize settings back to the default 50.
6. When the camera setup is done, press <OK>.



Setting the PTZ

To use Camera's PTZ functions, ID and protocols of each camera and DVR should be matched. For other settings, refer to the "Remote Devices" settings. (Page 50)

Using the mouse may help easy setup.

3. Use the up/down buttons (▲▼) in <Device> window to move to <Camera>, and press [ENTER] button.
4. Select <PTZ>. A window of PTZ settings appears.
5. Use direction buttons (▲▼◀▶) to move to a desired item, and select it.
 - ID : Set the ID of the connected camera of each channel. You can easily setup by using the numeric buttons on the remote control or front panel.
 - Protocol : Set the protocol of the connected camera of each channel.

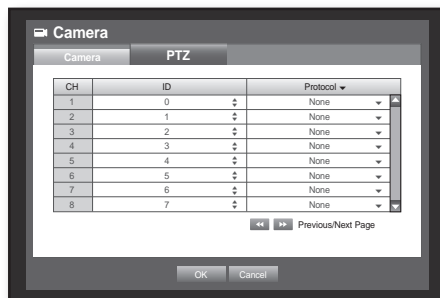

▪ You can check the camera's ID and protocol if you turn the camera off and on after connecting it to the DVR. (Page 69)

6. When the PTZ setup is done, press <OK>.

using the DVR

Storage Device

You can check information on storage devices.

Confirming Devices

You can check storage devices and their free space, usage as well as status.

Devices available are HDD, and USB devices (Memory, HDD, CD/DVD).

Refer to "**Product Specifications > Backup**". (Page 100)

Using the mouse may help easy setup.

3. Use the up/down buttons (▲▼) in <Device> window to move to <Storage Device>, and press [ENTER] button.

4. Select <Device>.

- No. : Shows the assigned number of the internal HDD.
 - To see the detailed positioning of the HDD according to the number, refer to <HDD Map>.
- Used/Total : Shows the used/total capacity of the storage device.
- Usage : Sets the storage device's usage.
 - USB memory is used only for backups.
 - External USB HDD, SATA HDD are used for extension and backup.
 - SRD-830/830D/1610/1610D/1630/1630D does not support a port for SATA connection.
- Status/Management : Shows the current status of the HDD, as in Normal/Check/Replace.
 - Normal : Available to use
 - Check : Available to use but recommended to replace
 - Replace : Requires immediate replacement.
- HDD Map : Shows the internal HDD's locations according to assigned numbers.
 - Refer to this for servicing or additional HDD installation.

5. To move to the previous menu, press <OK>.

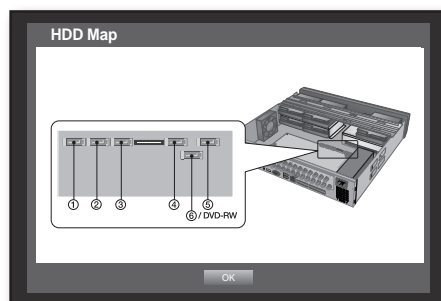
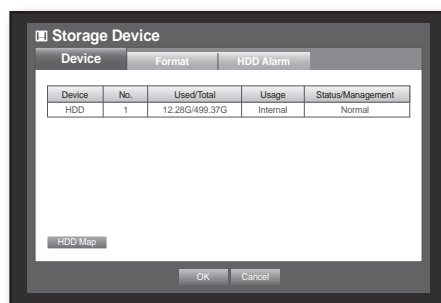

<SRD-830/830D/1610/1610D/1630/1630D>

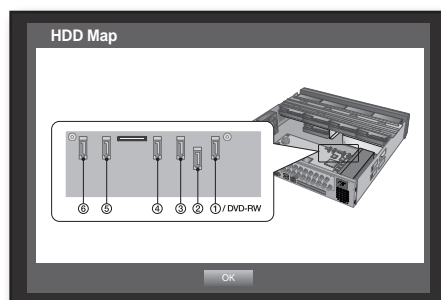

<SRD-850/850D/870/870D/1650/1650D/1670/1670D>

Formatting

You can format a storage device.

Using the mouse may help easy setup.

3. Use the up/down buttons (▲▼) in <Device> window to move to <Storage Device>, and press [ENTER] button.
4. Select <Format>.

A window for selection of device for formatting appears.
5. Use direction buttons (▲▼◀▶) to select a device to be formatted.

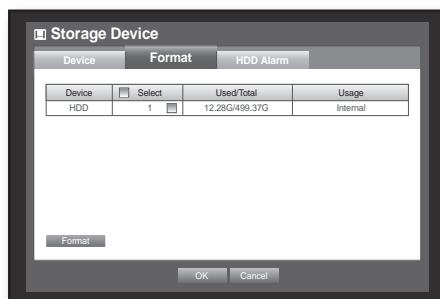

6. Select <Format> on the bottom of the screen.

Press <OK> on the "Manage" confirmation window will start formatting the selected device.
7. When the formatting is done, press <OK>.



HDD Alarm

You can set alarm settings for HDD defects such as Check Alarm Output Port, Replace Alarm Output Port, and its duration.

Using the mouse may help easy setup.

3. Use the up/down buttons (▲▼) in <Device> window to move to <Storage Device>, and press [ENTER] button.
4. Select <HDD Alarm>.

A window for setting HDD check and replace output ports and their durations appears.
5. Use direction buttons (▲▼◀▶) to move to the desired item.

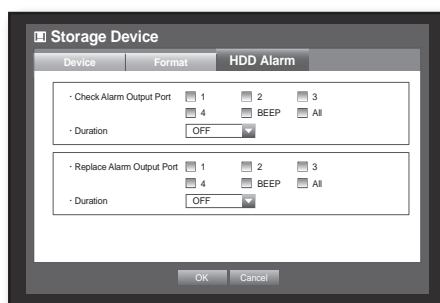

- Alarm
 - Alarm signal will output through the alarm out port on the rear side when selected <1>, <2>, <3>, and <4>.
 - If <BEEP> was selected, a beep will sound.
 - If <All> was selected, both beep sound and alarm signal through rear side ports will output.
- Check Alarm Output Port : If HDD generates check alarm, the alarm signal will output to the specified alarm output port.
- Replace Alarm Output Port : If HDD generates replace alarm, the alarm signal will output to the specified alarm output port.

using the DVR

- Duration : Sets the alarm duration for the alarm signal and beep sound.
 - Check Alarm, Replace Alarm signals will output through the selected alarm out ports (1, 2, 3, and 4).
 - If **<BEEP>** was selected, a beep will sound.
 - If **<All>** was selected, both beep sound and alarm signal through rear side ports will output.



- **<Check>** status means that the HDD is operating but it has problems that require technical examination. (🔧) appears on the Live screen.
- **<Replace>** status means that the HDD has defect and requires immediate replacement. (🗑️) appears on the Live screen.

6. When the HDD Alarm setup is done, press **<OK>**.

Remote Devices

You can set the RS-485 communication for use of PTZ Camera and system keyboard with the DVR.

Using the mouse may help easy setup.

3. Use the up/down buttons (▲▼) in **<Device>** window to move to **<Remote Device>**, and press [ENTER] button.
4. Use direction buttons (▲▼◀▶) to move to the desired item, and press [ENTER] button.
5. Set the values of each communication setup of the remote device.
 - Baudrate : Baud rate settings of the DVR, PTZ camera and system keyboard should be matched for proper operations.
6. Make sure to match IDs of the DVR, System Keyboard and Remote Control, and press **<OK>**.

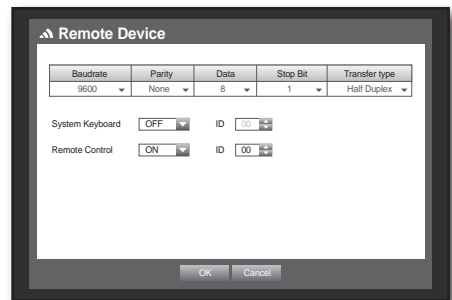

- For changing the remote control's ID, refer to **"Changing the Remote Control ID"**. (Page 14)

POS Devices

You can set properties of POS devices connected to the DVR.

A POS device connection requires channel, preset, and Port/Ethernet settings.

Using the mouse may help easy setup.

3. Use the up/down buttons (▲▼) in **<Device>** window to move to **<POS Device>**, and press [ENTER] button.
4. Use direction buttons (▲▼◀▶) to move to a desired item, and set the value.
 - POS USE : When selected **<POS USE>**, DVR and POS will be connected.



- If you change settings for the device and press **<OK>** while the **<POS USE>** is not checked, the changes for POS device will not be saved.

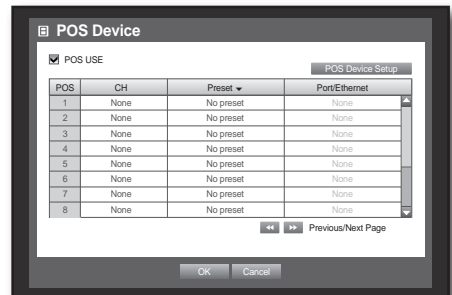

- POS Device Setup : Sets the communication setups for the POS device and DVR.
 - It is independent to the Remote Device setup.

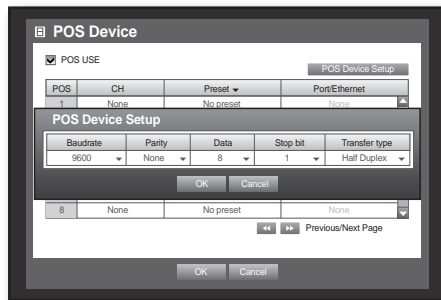

- CH : Select the camera to be synchronized to the POS device.
 - If selected a channel input field, “Sync Channel Setup” window appears.
 - One POS device and be synchronized up to 16 cameras (channels), and a channel can not be synchronized to multiple POS devices.
 - Channels to be synchronized to a POS device should be set to “Event” in “Main Menu > Record > Recording Schedule”. (Page 54)

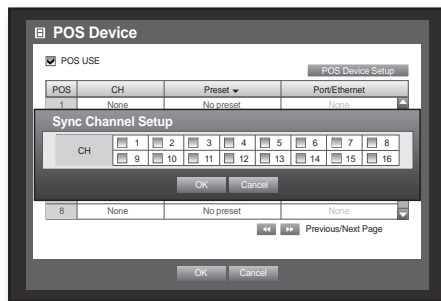

- Preset : Sets the name, start and end strings of the receipt for the preset.
 - Preset name should be unique.
 - Use <Add> button to display “Add Preset” window, and set its name, start string, and end string.



- Port/Ethernet : Sets the port number for the DVR and POS device connection.
 - COM1 : For RS-232C connections
 - 7001~7016 : For Ethernet connections
- 5. When the POS Device setup is done, press <OK>.

using the DVR

Monitor

You can configure information to be displayed and its format for Spot Out monitor.

Setting the Monitor

Using the mouse may help easy setup.

3. Use the up/down buttons (▲▼) in <Device> window to move to <Monitor>, and press [ENTER] button.

4. Select <Monitor>.

5. Use direction buttons (▲▼◀▶) to move to a desired item, and set the value.

- Event Display : Sets the dwell time of the event channel display on the monitor when an event occurs.
If selected <Continuous>, it displays the channel until you press [ALARM] button to release it.
 - Display : Displays only checked items on the monitor screen.
 - Multi CH SEQ Time : Sets the interval between automatic display switching in 4-split and 9-split mode of the Live screen.
 - VGA, HDMI : Select between <VGA> and <HDMI> for screen output.
Outputs either one of <VGA> and <HDMI>.
If the output setting of <VGA> or <HDMI> does not match to the monitor, video may not be produced.
In this case, press and hold the [MODE] and [ZOOM] buttons simultaneously for around 5 seconds to change the video output.
 - SRD-830/830D/1610/1610D/1630/1630D does not support the HDMI signal.
 - Sharpness : You can adjust the sharpness of the video output signal.
6. When the monitor setup is done, press <OK>.

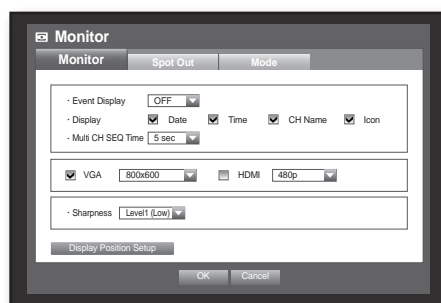

Screen Setup

Some monitors may not display information (camera name, icon, time information, etc.) about the DVR, depending on the condition. Then, you can change the display position of the data.

3. In the <Device> window, press the up/down (▲▼) button to move to <Monitor> and press the [ENTER] button.

4. Select the <Monitor> item.

5. Select <Display Position Setup> in the bottom.
You will move to the <Display Position Setup> window.

6. Use the four direction buttons or the number buttons on the front panel or the remote control to adjust the data position.

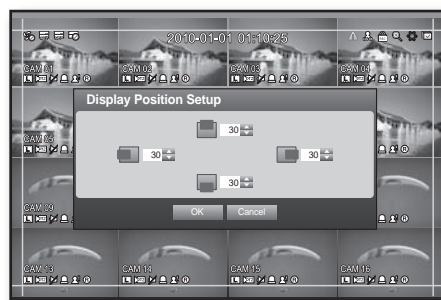

Setting the Spot Out

You can set the DVR to output information / video apart from the monitor out.

Using the mouse may help easy setup.

3. Use the up/down buttons (▲▼) in <Device> window to move to <Monitor>, and press [ENTER] button.
4. Select <Spot Out>.
 - The number of Spot Out terminals differs according to the model.
5. Use direction buttons (▲▼◀▶) to move to a desired item, and set the value.

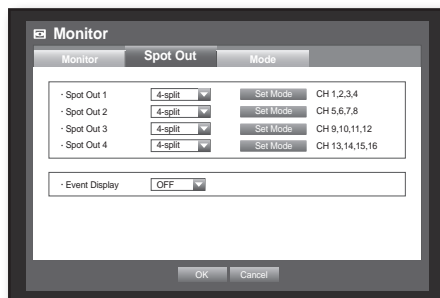

- Spot Out 1 : You can select between 16-, 9-, 4-split, Auto Sequence, and Single.
- Spot Out 2~4 : Only supports 4 channels, with 4-split, Auto Sequence, and Single mode.
- Set Mode : A window for “Set Spot Out” appears and you can set the channel for it. You can set the dwell time between the screen switching in “Setting the Device > Camera > SEQ-Dwell Time”. (Page 46)
- Event Display : Sets the duration for the Spot Out on an event. If selected <OFF>, an event will not output to the Spot Out.

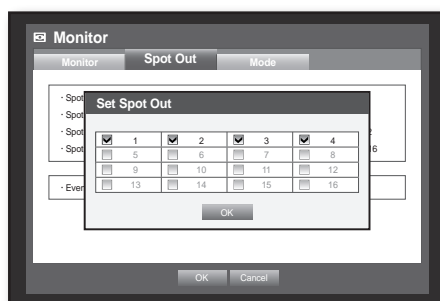

- You can setup using the mouse right button in Live screen. Refer to “Spot Out”. (Page 33)

6. When the Spot Out is done, press <OK>.

Setting the Screen Mode

You can configure the Live screen and Split Screens.

Using the mouse may help easy setup.

3. Use the up/down buttons (▲▼) in <Device> window to move to <Monitor>, and press [ENTER] button.
4. Select <Mode>.
5. Use direction buttons (▲▼◀▶) to move to a desired item, and set the value.
 - Live Screen : Select split modes for the Live screen. 16-, 9-, and 4-split screens are included by default.
 - Play Screen : Select split modes for the playback screen. Only the 13-split screen is optional. Black shows the playback while white shows the Live screen.
6. When the screen mode setup is done, press <OK>.

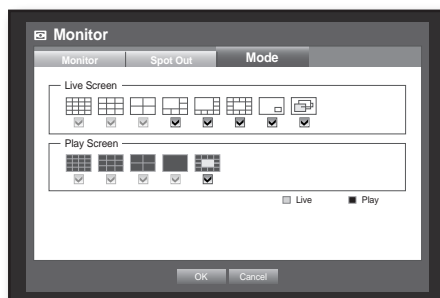

using the DVR

SETTING THE RECORDING

You can setup scheduled recording, event recording and other recording related settings.

Recording Schedule

Make your reservation on a date and time to schedule the recording on specified time.

Using the mouse may help easy setup.

1. Press the [MENU] button on the remote control or front panel.
2. Use the left/right button (◀ ▶) to select <Record>. Record menu is selected.
3. Use the up/down buttons (▲ ▼) to move to <Recording Schedule>, and press [ENTER] button.



4. Select <Recording Schedule>. A window of scheduled recording setup appears.
5. Use direction buttons (▲ ▼ ◀ ▶) to move to a desired item, and set the value.

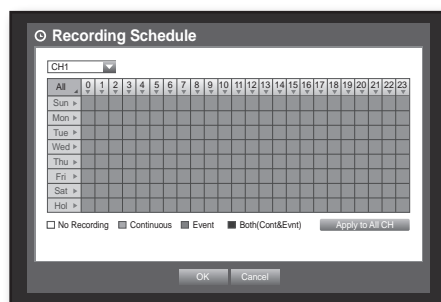

- Apply to All CH : If selected <Apply to All CH>, "Apply to All CH" window appears. Press <OK> to apply the setup to all channels.
6. When the recording schedule setup is done, press <OK>.

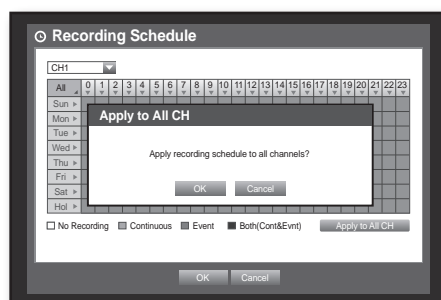

Recording Color Tags

Color	Function	Description
White	No Recording	No schedule / event recording
Orange	Continuous	Scheduled recording only
Blue	Event	Event recording only
Green	Both(Cont&Evt)	Both scheduled / event recordings

Each press of a selected cell will cycle through <No Recording>-<Continuous>-<Event>-<Both(Cont&Evt)>.

Event Record Duration

You can set the beginning and ending point of a recording on an event.
Using the mouse may help easy setup.

- Use the up/down buttons (▲▼) in <Record> window to move to <Event Record Duration>, and press [ENTER] button.
- Use direction buttons (▲▼◀▶) to move to a desired item, and set the value.
 - Pre Event : The recording will be kept from the point of set pre-event time earlier than the actual occurrence of an event.
If it is set to 5 seconds, the recording begins from 5 seconds before the event.
 - POST Event : The recording will be kept to the point of set post-event time after than the actual end of an event.
If it is set to 5 seconds, the recording ends in 5 seconds after an event.
- When the event recording duration setup is done, press <OK>.

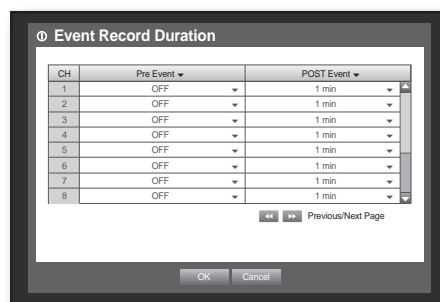

REC Quality / Resolution

You can set resolution, IPS, and quality of recordings by channel, and by recording type of standard / event.

Setting Standard Recording Properties

You can set each channel's resolution, quality and IPS for normal recordings.
Using the mouse may help easy setup.

- Use the up/down buttons (▲▼) in <Record> window to move to <REC Quality & Resolution>, and press [ENTER] button.
- Select <Standard>.
- When the recording setup is done, press <OK>.
 - Remaining count : If you change the settings of the resolution and the remaining rate, the frame rate available for each resolution will be recalculated.
 - The <Remaining count> will be displayed only for SRD-830/830D/850/850D/1610/1610D/1630/1630D/1650/1650D models.
 - SRD-870/870D/1670/1670D models have no limitations on the remaining rate.

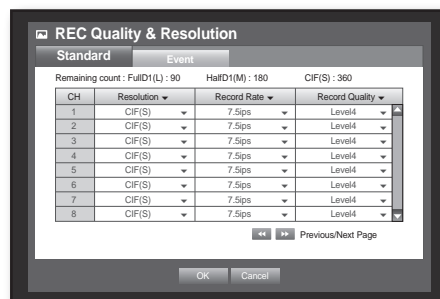

using the DVR

Setting Event Recording Properties

You can set each channel's resolution, quality and IPS for event recordings.

Using the mouse may help easy setup.

- Use the up/down buttons (▲▼) in <Record> window to move to <REC Quality & Resolution>, and press [ENTER] button.
- Select <Event>. Event recording setup window appears.
- Use direction buttons (▲▼◀▶) to move to a desired item, and select it.
- Resolution : Sets the resolution of the recorded screen.
 - If you set the resolution to <Full D1(L)>, SRD-850/850D/1650/1650D support up to 4 channels while SRD-1630/1630D support up to 2 channels and SRD-830/830D/1610/1610D support just one channel.



Resolution

Name	Resolution	Description
CIF(S)	NTSC: 352 X 240, PAL: 352 X 288	Samples each half of horizontal and vertical screen.
Half D1(M)	NTSC: 704 X 240, PAL: 704 X 288	Samples half of the horizontal screen.
Full D1(L)	NTSC: 704 X 480, PAL: 704 X 576	Samples original screen size.

- Record Rate : Image Per Second, means the frames recorded per a second.
 - Record Quality : Sets the recording quality.
-  The estimated total remaining count for SRD-830/830D/850/850D/1610/1610D/1630/1630D/1650/1650D means the total number of remaining recordings for both standard and event recordings.
- You cannot increase the remaining count if the current remaining count has reached zero or there is no available remaining count from any other page. If this is the case, reduce the remaining count for the current page, or do so for the same channel on any other page.
- When the Event recording setup is done, press <OK>.

Record Option

You can set the recording to stop or overwrite when the HDD is full.

Using the mouse may help easy setup.

- Use the up/down buttons (▲▼) in <Record> window to move to <Record Option>, and press [ENTER] button.
- Use direction buttons (▲▼◀▶) to move to a desired item, and set the value.

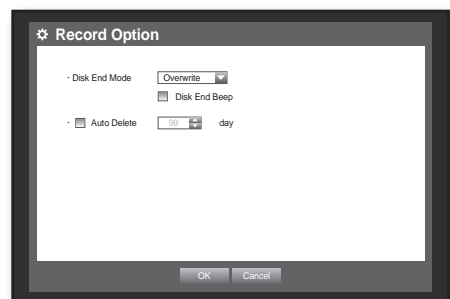

- Disk End Mode : If selected <Overwrite>, recording will continue despite the HDD full while overwriting the oldest.
If selected <Stop>, the recording will stop when the HDD is full.
 - Disk End Beep : If selected <Stop>, the button is activated.
If you check it, the beep will sound on the disk full and the recording stops.
 - Auto Delete : If you check it, Record Period setup is activated.
If you setup the auto delete, recorded data only in the configured period are searchable.
5. When the recording option setup is done, press <OK>.

SETTING THE EVENT

You can set recording options for sensor, motion, and video loss event.

Sensor Detection

You can set the sensor's operating condition and connected camera, as well as alarm output and its duration. Using the mouse may help easy setup.

1. Press the [MENU] button on the remote control or front panel.
2. Use the left/right button (◀▶) to select <Event>.
Event setting menu is selected.



3. Use the up/down buttons (▲▼) to move to <Sensor Detection>, and press [ENTER] button.
A window of sensor detection setup appears.

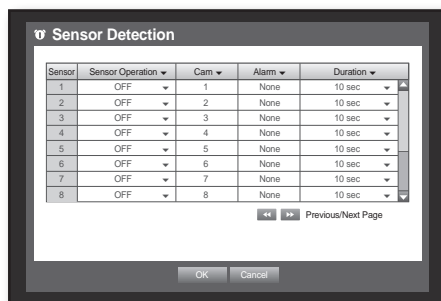

4. Use direction buttons (▲▼◀▶) to move to a desired item, and set the value.
- Sensor Operation : Sets the operation mode of sensors.
 - <OFF> : Sensor does not operate.
 - <N.O (Normal Open)> : Sensor is opened.
If the sensor is closed, it generates alarm.
 - <N.C (Normal Close)> : Sensor is closed.
If the sensor is open by interruption, it generates alarm.
 - Cam : Select a channel to be connected to the sensor.
If selected camera, "Cam Preset setup" window appears.
 - Preset setup can be done in PTZ mode.

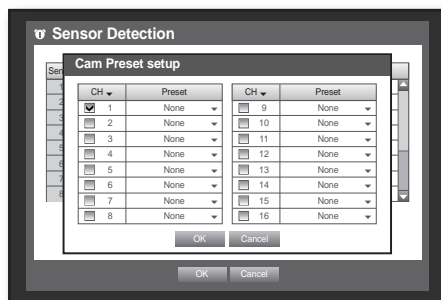

using the DVR

- Alarm : Sets the alarm output method.
 - For further information on alarm output, refer to “**HDD Alarm > Alarm**”. (Page 49)
- Duration : Sets the duration of alarm signal and alarm sound.
- 5. When the sensor detection setup is done, press <OK>.

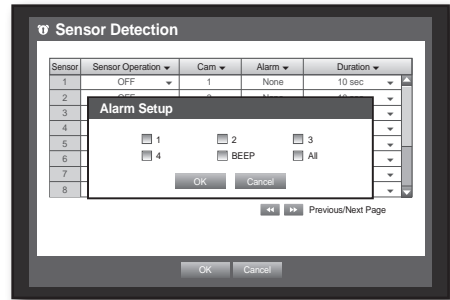

Motion Detection

You can set target detection region and motion, as well as the alarm signal output. When the motion detection region is set, it detects motion within the area.

Using the mouse may help easy setup.

3. Use the up/down buttons (▲▼) in <Event> window to move to <Motion Detection>, and press [ENTER] button. A window of motion detection area setup appears.
4. Use direction buttons (▲▼◀▶) to move to a desired item, and set the value.
 - Mode : Sets whether to activate motion detection.
 - Sensitivity : Sets the sensitivity level of the motion detection.
 - Alarm : Sets the alarm output method.
 - For further information on alarm output, refer to “**HDD Alarm > Alarm**”. (Page 49)
 - Alarm Duration : Sets the duration of alarm signal and alarm sound.
5. When the motion detection setup is done, press <OK>.

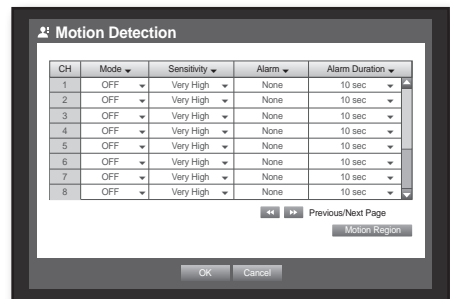

Setting the Motion Detection Area

- ① Select <Motion Region>.
- ② When “Motion Region” window appears, select a channel for detection and set the area of motion detection.
 - To set the area in “Motion Region” window
In the “Motion Region” window, select desired region from <[Icons]>.
 - To set the area using <Individual> selection
In the “Motion Region” window, you can select cells individually by using <Individual>.

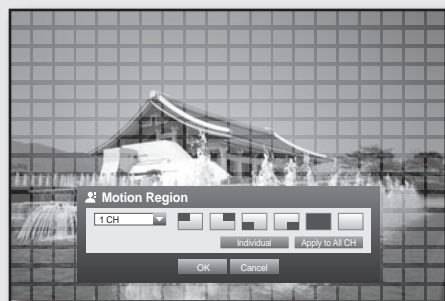

When selected <Individual>, “Motion Region” window disappears and you can select cells one by one. When the motion area setup is done, press the <Menu> on the screen or the [MENU] button on the remote control or front panel to display the “Motion Region” window again.

- Select : Selected cell is set to be a part of motion detection area.
- Unselect : Selected cell is removed from the motion detection area.
- Inverse : Unselected cells are set to be the motion detection area.
- Menu : After selecting individual motion areas, move to the “Motion Region” window.
 - If selected <Apply to All CH>, selected motion area is applied to all channels.

- ✓ Select
- Unselect
- Inverse
- Menu

- ③ When the motion detection setup is done, press <OK>.

Video Loss Detection

You can set the alarm to be generated on a camera disconnection, which causes a video loss. Using the mouse may help easy setup.

3. Use the up/down buttons (▲▼) in <Event> window to move to <Video Loss Detection>, and press [ENTER] button.
A window of video loss detection area setup appears.
4. Use direction buttons (▲▼◀▶) to move to a desired item, and set the value.
 - Video Loss State : Sets whether to activate video loss detection.
 - Alarm : Sets the alarm output method.
 - For further information on alarm output, refer to “HDD Alarm > Alarm”. (Page 49)
 - Alarm Duration : Sets the duration of alarm signal and alarm sound.
5. When the video loss detection setup is done, press <OK>.

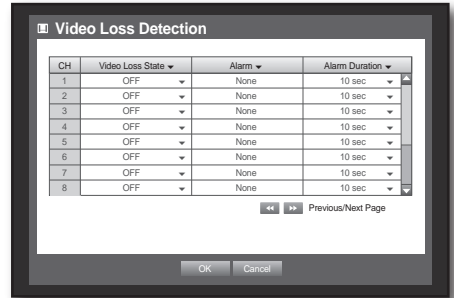

Alarm Schedule

You can set the conditions and operating hours for scheduled alarms. Using the mouse may help easy setup.

3. Use the up/down buttons (▲▼) in <Event> window to move to <Alarm Schedule>, and press [ENTER] button.
 4. A window of <Alarm Schedule> settings appears.
 5. Alarm : Sets the alarm output method.
 - For further information on alarm output, refer to “HDD Alarm > Alarm”. (Page 49)
 - <ON> : Marked in orange, and always generates alarm on scheduled time.
 - <OFF> : Marked in white, no alarm is generated even if an event occurs.
 - Event Sync : Marked in Blue, generates alarm only when an event occurs.
 - Apply to All Alarm : Applies the configured schedule to all alarms.
-  When the alarm is generated on the scheduled time, you can stop the alarm by canceling the schedule.
6. When the Alarm Schedule setup is done, press <OK>.

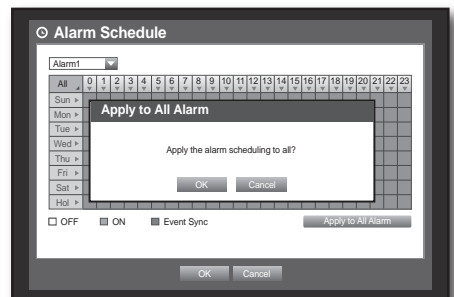
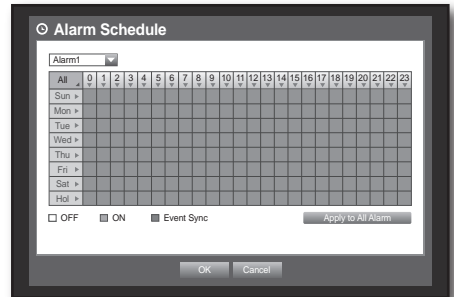

using the DVR

BACKUP

You can check the backup device and set the backup schedule by channel or by time.
The product only supports external HDD of USB memory/DVD and USB/SATA type. (Page 100)

Setting the Backup

You can backup the desired data to a connected device.
Using the mouse may help easy setup.

1. Press the [MENU] button on the remote control or front panel.
2. Use the left/right button (◀ ▶) to select <Backup>. Backup menu is selected.



3. Press the [ENTER] button.
A backup window appears.
You can directly access it from the "Live screen menu". (Page 28)

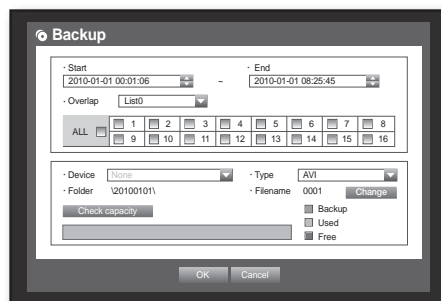

4. Use direction buttons (▲▼◀▶) to move to a desired item, and set the value.
 - Backup Range : Sets the <Start> and <End> time for the backup.
 - Channel : Sets the channel to backup.
You can select multiple channels.
 - Device : Select a backup device from the recognized devices.
If the built-in internal CD/DVD or external USB CD/DVD is used for the backup, you can select the format of recording between AVI and SEC.
 - Since SRD-830/850/870/1610/1630/1650/1670 models do not have built-in internal DVD Writer, internal CD/DVD backup is not available.
 - Type : Sets the backup data format.
 - AVI : Saves the CODEC information provided by the DVR with the recording data, and saved data can be played back by using external viewers (such as Windows Media Player) on a PC.
 - DVR : Saved data can be played back only by the DVR.
 - SEC : Saves data in the Samsung's proprietary format with built-in viewer, which supports immediate playback on a PC.
 - Filename : You can set the back file name.
 - Refer to "Using Virtual Keyboard". (Page 38)
 - Check capacity : Shows the size of the selected backup data, used and available capacity of the selected backup device.
 - Overlap : Shows a list of overlapping data on a same time according to the number of data.
It appears when one channel has multiple data on a certain time point due to changing of time or time zone settings, etc.
 - Refer to time and time zone of "Setting the Date/Time/Language". (Page 36)

5. When the backup setup is done, press <OK>.
 - If no available device is recognized for backup, <OK> button is not activated.
- ! ▪ The application may slow down during the backup.
- You can switch to the menu screen during the backup in operation, but playback of data is not available.
 - When a CD/DVD or memory device is used for backup, it is not available to use the full capacity of the media since the system consumes a part of its capacity.
 - If a CD or DVD media causes errors, the disc tray opens and closes a several times, and eventually backup process will fail. In this case, replace the CD/DVD media and try again.
- ✍ ▪ Pressing the <Exit> during the backup will return to the previous menu, while the backup progresses.

NETWORK CONFIGURATION

It provides networked monitoring of Live screen from a remote place, and supports mail forwarding function with events. You can configure the network environment which enables such functions.

Connection Mode

You can set the network connection route and protocol.

Setting the Connection

Sets the protocol and environment of the network.

Using the mouse may help easy setup.

1. Press the [MENU] button on the remote control or front panel.
2. Use the left/right button (◀ ▶) to select <Network>. Network menu is selected.
3. Use the up/down buttons (▲ ▼) to move to <Connection Mode>, and press [ENTER] button.

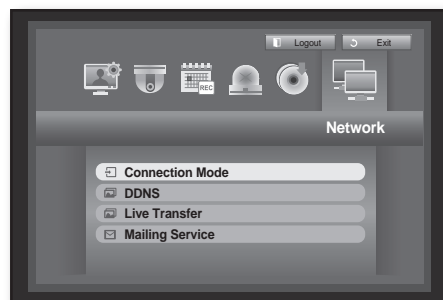

4. Select <Connection>. A window of connection mode setup appears.
5. Use direction buttons (▲ ▼ ◀ ▶) to move to a desired item, and set the value.
 - Connection Mode : Sets the network connection mode.
 - Bandwidth : Sets the maximum data flow to be transferred. (Upload speed)
Options will vary depending on the selected connection mode.
 - For <Static IP>, <Dynamic IP> : Select one from 50 kbps ~ 2Mbps, and Unlimited.
 - For <ADSL>, select one from 50 kbps ~ 600 kbps.

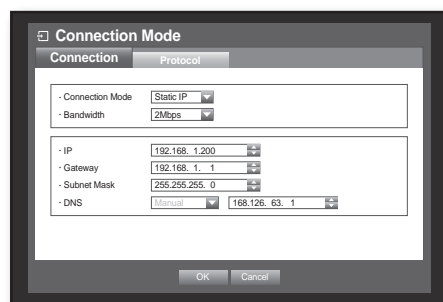

using the DVR

- IP, Gateway, Subnet Mask, and DNS
 - For <Static IP> : You can directly input IP address, Gateway, Subnet Mask and DNS.
 - For <Dynamic IP> : IP address, Gateway, and Subnet Mask are set automatically.
 - For <ADSL> : IP address, Gateway, and Subnet Mask are set automatically.
- User ID, Password : In case you selected ADSL, provide the "User ID" and its "Password".

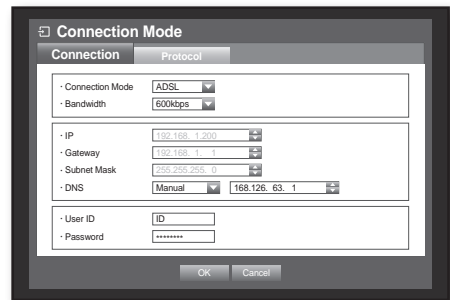

- DNS server for <Dynamic IP> and <ADSL> can be set by user only if you selected <Manual>.

6. When the connection setup is done, press <OK>.

Setting the Protocol

3. Use the up/down buttons (▲▼) in <Network> window to move to <Connection Mode>, and press [ENTER] button.

4. Select <Protocol>.

5. Use direction buttons (▲▼◀▶) to move to a desired item, and set the value.

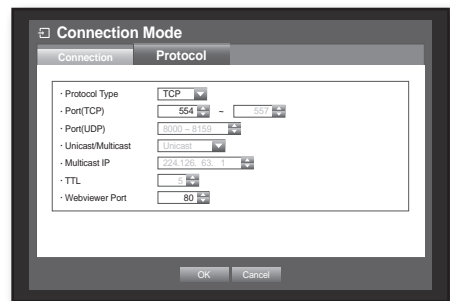

- Protocol Type : Select the protocol type between TCP and UDP.
 - If selected UDP, selections of Port (TCP), Port (UDP), and Unicast/Multicast are activated.
 - Port (TCP) : Initially, <554~557> is set. It increases / decreases by 4.
 - TCP : It has better stability and lower speed when compared to UDP, and recommended for internet environments.
 - Port (UDP) : Initially, <8000~8159> is set. It increases / decreases by 160.
 - UDP : It has less stability and faster speed when compared to TCP, and recommended for local area network (LAN) environments.
 - Unicast/Multicast : Select one between Unicast and Multicast. If selected Multicast, Multicast IP and TTL are activated.
 - Unicast : Transfers data (UDP, TCP) individually to each connecting client.
 - Multicast : Multiple client can receive the data (only in UDP) without putting additional traffic load to the network.
 - Multicast IP : User can directly input.
 - TTL : Select from 0 ~ 255. Initial value for the TTL is set to <5>.
 - Webviewer Port : Enter the port number for the Web Viewer. Initially, it is set to <80>.
6. When the protocol setup is done, press <OK>.

DDNS

You can set the DDNS site for a remote user's network connection.
Using the mouse may help easy setup.

3. Use the up/down buttons (▲▼) in <Network> window to move to <DDNS>, and press [ENTER] button.
4. Use virtual keyboard to enter user inputs.
 - Refer to "Using Virtual Keyboard". (Page 38)
 - If selected <OFF> or <Samsung DDNS>, input fields are deactivated.
5. When the DDNS setup is done, press <OK>.



- Refer to <DDNS Setting>. (Page 65)



Connecting and Setting the Network

Networking may differ from the connection method, check your environment before setting the connection mode.

When no router is used

• Static IP mode

- Internet connection : Static IP ADSL, leased line, and LAN environments allows connection between the DVR and remote user.
- DVR Network Settings : Set the <Connection Mode> in <Connection> menu of the connected DVR to <Static IP>.
 - Consult your network manager for IP, Gateway and Subnet Mask.

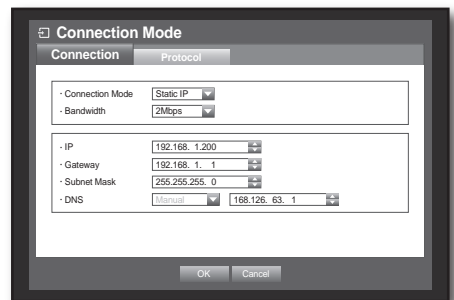

• Dynamic IP (DHCP) mode

- Internet connection : Connect the DVR directly to a cable modem, DHCP ADSL modem or FTTH network.
- DVR Network Settings : Set the <Connection Mode> in <Connection> menu of the connected DVR to <Dynamic IP>.

• ADSL (PPPoE: ID and password certification)

- Internet connection : An ADSL modem is directly connected to the DVR, where the ADSL connection requires user ID and password.
- DVR Network Settings : Set the <Connection Mode> in <Connection> menu of the connected DVR to <ADSL>.
 - ADSL <User ID> and <Password> should be the same to the ADSL user information.
If you don't know the ID and password, consult your ADSL service provider.

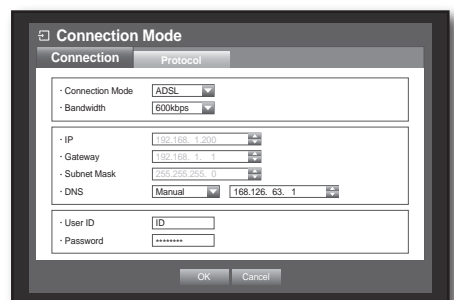

using the DVR

When a router is used

! To avoid IP address conflict with the DVR's static IP, check followings :

• Setting the DVR with a static IP

- Internet connection : You can connect the DVR to a router which is connected to an ADSL/Cable modem or a router in a Local Area Network (LAN) environment.

• Setting the DVR Network

1. Set the <Connection Mode> in <Connection> menu of the connected DVR to <Static IP>.

2. Check whether the set IP address is in the static IP range provided by the IP router.

IP, Gateway, and Subnet Mask : Consult your network manager.

▪ Check whether the set IP address is in the static IP range provided by the IP router.

! If a DHCP server is configured with starting address (192.168.0.100) and end address (192.168.0.200), you should set the IP address out of the configured DHCP range (192.168.0.2 ~ 192.168.0.99 and 192.168.0.201 ~ 192.168.0.254).

3. Check the Gateway address and subnet mask are equal to those set in the IP router.

• Setting the DHCP IP Address of the IP router

1. To access the IP router's configurations, open a web browser on the local PC that is connected to the IP router and enter the router's address (ex : http://192.168.1.1).

2. At this stage, make the local PC's windows network configurations to the below example :

Ex) IP : 192.168.1.2

Subnet Mask : 255.255.255.0

Gateway : 192.168.1.1

- Once connected to the IP router, it prompts with password. While entering nothing to the User Name field, enter "admin" into the password field and press <OK> to access the router configurations.

- Access the router's DHCP configuration menu and set its DHCP server activation, and provide the start and end address.

Set the start address (192.168.0.100) and end address (192.168.0.200).

✍ Above steps may differ from the router devices depending on the manufacturer.

• Setting Router's Port Forwarding

1. Set the protocol to <TCP>.

2. External Port Range : Enter the TCP Port set in the <Port(TCP)> in <Protocol> menu of the connected DVR. If more than one DVRs are connected to the router, the TCP port can be different.

3. Internal PC IP Address : Enter the IP address set to the <IP> in <Connection> menu of the connected DVR.

4. Internal Port Range : Set the same to the "External Port Range".

✍ Above steps may differ from the router devices depending on the manufacturer. Port forwarding is required when you want to access the DVR connected to the router from outside of the router's network.

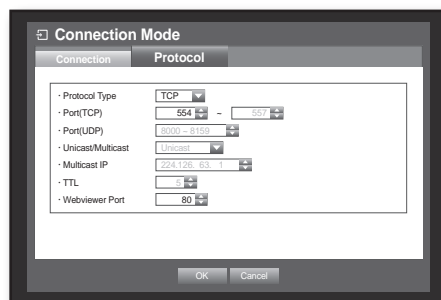

DDNS Setting

DDNS is a short form of Dynamic Domain Naming System.

DNS (Domain Name System) is a service that routes a domain name consisting of user friendly characters (ex : www.google.com) to an IP address consisting of numbers (64.233.189.104).

DDNS (Dynamic DNS) is a service that registers a domain name and the floating IP address with the DDNS server so that the domain name can be routed to the IP address even if the IP is changed in a dynamic IP system.

• Setting DDNS in the DVR

Set <**Protocol Type**> in the <**Protocol**> menu of the connected DVR to the following :

Ex) Protocol Type : TCP

Port (TCP) : 0554,0555,0556,0557

DDNS Site : Samsung DDNS

• DDNS Settings of the Router

Select the corresponding menu for the network transfer protocol of the router.

Live Transfer

Sets the quality of the image that is transferred from the DVR to the network.

Using the mouse may help easy setup.

3. In the <**Network**> setting window, press the up/down (▲▼) button to move to <**Live Transfer**> and press the [ENTER] button.
The Live Transfer window appears.
4. Use the direction buttons (▲▼◀▶) to move to a desired item and set the value.
5. When the live transfer is done, press <**OK**>.
 - For the resolution of the live transfer, refer to "**Resolution**".
(Page 56)

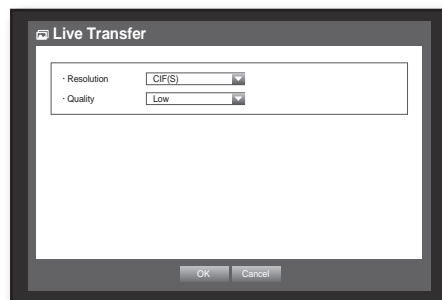

using the DVR

Mailing Service

You can send an e-mail to a DVR-registered user at a specific time interval, or if an event occurs.

- If an event occurs with a channel where the camera's video is set to <OFF> or the remaining recording count is set to <OFF>, only the text notification will be sent to the applicable email address.

SMTP Setting

Sets the SMTP mail server.

Using the mouse may help easy setup.

3. In the <Network> setting window, press the up/down (▲▼) button to move to <Mailing Service> and press the [ENTER] button.

4. Select <SMTP>.

You will see the SMTP setting window.

5. Use direction buttons (▲▼◀▶) to move to a desired item and set the value.

- ServerType : Displays the connected server type.
 - Server : Enter a server to connect to.
 - Port : Sets the communication port.
 - Use Authentication : Check this if the SMTP server uses user authentication. The account input box will be activated.
 - User : Enter a user to use authentication when connecting to the SMTP server.
 - Password : Enter the password of the SMTP server user.
 - Secure Transfer : Select one from <Never> and <TLS (if available)>.
 - Sender : Use the virtual keyboard to enter the sender's e-mail address.
 - Refer to "Using Virtual Keyboard". (Page 38)
 - TEST : Conducts the test on the server settings.
6. When the SMTP setting is done, press <OK>.

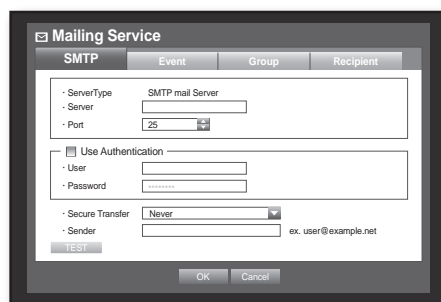

Event Setting

You can set the interval and type of the event that will be sent to the user.

Using the mouse may help easy setup.

3. In the <Network> setting window, press the up/down (▲▼) button to move to <Mailing Service> and press the [ENTER] button.

4. Select <Event>.

5. Use direction buttons (▲▼◀▶) to move to a desired item and set the value.

- Event Interval : Set the event interval.
 - If a series of events occurs, the e-mail will be sent at the specified interval, not on each event.
 - Use Event Transfer : Select an event type to send if an event occurs. If the selected event occurs, the e-mail will be sent to the group that has the recipient authority.
6. When the event setting is done, press <OK>.



Group Setting

You can set the group to whom the e-mail is sent, and specify the permission for each group.

You can add recipients for each group in the <Recipient> menu item.

The recipient is set separately from the DVR user group.

Using the mouse may help easy setup.

3. In the <Network> setting window, press the up/down (▲▼) button to move to <Mailing Service> and press the [ENTER] button.
4. Select <Group>.
5. Use direction buttons (▲▼◀▶) to move to a desired item and set the value.
 - Add : Select <Add> and use the virtual keyboard to add a group.
 - Refer to “Using Virtual Keyboard”. (Page 38)
 - Delete : Deletes the selected group.
 - Rename : You can reset the recipient permission of an existing group.
 - Recipient Permission : Set the permission of the recipient group.
6. When the group setting is done, press <OK>.



Recipient Setting

You can add a user to the group or delete him/her from the group, or change the group.

Using the mouse may help easy setup.

3. In the <Network> setting window, press the up/down (▲▼) button to move to <Mailing Service> and press the [ENTER] button.
4. Select <Recipient>.
5. Use direction buttons (▲▼◀▶) to move to a desired item and set the value.
 - Add : You can select a recipient name, e-mail address or group. You should have created a group in the <Group> menu item before you can add a user to the group.
 - Refer to “Using Virtual Keyboard” for input of the user name and the e-mail address. (Page 38)
6. When the recipient setting is done, press <OK>.

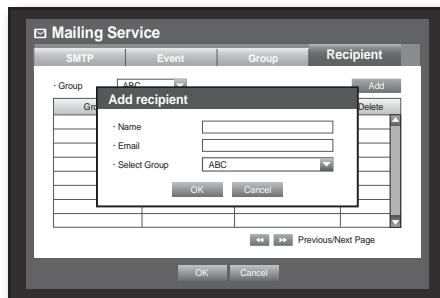
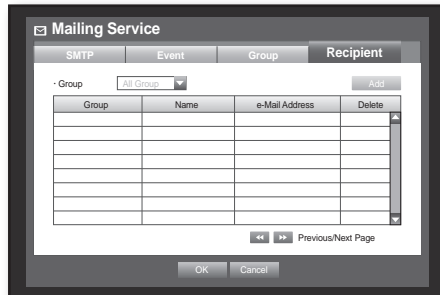

using the DVR

CONTROLLING A PTZ DEVICE



The DVR enables you to adjust the settings of a PTZ camera as well as an ordinary one to your preference.

PTZ Device

The PTZ device can be activated only if a channel in connection with the PTZ camera is selected.

Getting started with PTZ

The PTZ camera is available, only if a channel is selected, in the following way :

- Using the button on the remote control or the front panel
Select the **[PTZ]** button on the remote control or the front panel.
 - Using the launcher menu
Click PTZ < **PTZ** > to display the live launcher.
 - Using the right-click menu in Live mode
Right-click any area on the screen to display the context menu, and select < **PTZ Control** >.
-
- Using icons on the live screen
Click the PTZ <  > icon on the live screen.
-
-  The PTZ function is available only if the PTZ camera is connected so that the PTZ icon is displayed on the screen.

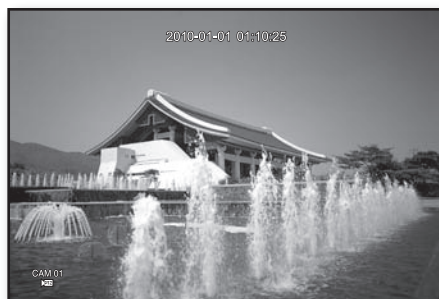

Using the PTZ camera

You can use one camera to perform all functions of PAN, TILT and ZOOM for monitoring multiple places and set the preset to your preference in a desired mode.

1. Launch the < **PTZ Control** > menu.
As the PTZ <  > icon on the bottom right corner turns yellow, you access the “**PTZ Control**” mode to display the “**PTZ Control**” menu.
 2. Use direction keys in the launcher menu or use direction buttons (▲▼◀▶) on the remote control or the front panel to move the target area to record.
- PTZ Wheel : Clicking a nearer point to the center will move in that direction slowly; clicking a farther point from the center will move fast.
 - Keep clicking left to rotate the lens counter clockwise; keep clicking right to rotate the lens clockwise.
 - Zoom : You can use the Zoom function of the PTZ camera.
 - IRIS : Adjusts the intensity of radiation incoming to the iris.



- Focus : Enables you to adjust the focus manually.
 - Auto Pan : The camera automatically runs between the two points that you selected.
 - Scan : The camera moves to the preset points in the specified sequence.
If multiple presets are specified, the PTZ camera will automatically move to all of the preset points one at a time.
 - Pattern : Makes the PTZ camera remember and follow the past route.
 - The functions of Auto Pan, Scan and Pattern are supported in the protocols of Samsung, Panasonic and Pelco, and are different in terms of the name and setting, depending on the protocols of Samsung, Panasonic and Pelco.
(Panasonic : Auto Pan, Sequence, Sort / Pelco : Auto Pan, Frame Scan, Pattern)
-  ▪ Before entering the PTZ device control mode, set the values of the PTZ device in the <Setting the PTZ> menu. (Page 47)

Preset Setting

A preset is a set of specific target points of a PTZ camera, and up to 20 presets per a camera can be stored. Using the mouse may help easy setup.

1. In PTZ Control mode, use the direction buttons to adjust the camera in a desired direction.
2. Select the <Save> key.
The virtual keyboard for inputting the preset will appear.
 - Refer to "Using Virtual Keyboard". (Page 38)

- Save : You can add and save the preset.
- Rename : You can change the settings of the existing presets.
- Delete : Deletes the selected preset.
- Delete All : Deletes all existing presets.

 ▪ If you replace the camera of the channel that stores the preset list with a new one, you should reset the preset accordingly.

3. Press <OK>.
The preset will be saved as a name that you entered.

Camera Setting

A PTZ camera has its own menu system. Optimize the PTZ camera according to the DVR. Using the mouse may help easy setup.

1. Connect the PTZ camera to the DVR and run the PTZ camera again to display the camera's protocol setting window.
2. Check the protocol ID of the camera.
 - In "Device > Setting the PTZ", enter the PTZ camera ID in the ID input box of the channel that is connected to the PTZ camera. (Page 47)

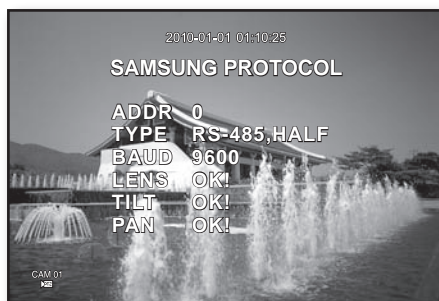

3. Select <Camera Setup> in the PTZ Control menu. The camera-specific menu appears.
 - You can configure the settings of only those cameras that support the protocols of Samsung, Pelco D/P, AD and Panasonic.
 - If you are setting Auto Pan or Pattern in the camera menu, press and hold the appropriate button for a certain time so that the button operation can be different from that in normal PTZ setting.



search & play

SEARCH

You can perform the search for recorded data by the time or by the search criteria such as an event. You can access the <Search> menu directly in Live mode.

1. In Live mode, right-click any area of the screen. The Live menu appears.
2. Select <Search>. Or, press the [SEARCH] button on the remote control or the front panel.



3. The Search menu appears.
 - If you have not checked "POS USE" in the "Main Menu > Device > POS Device" menu, the Search menu does not include the "POS Search" item. (Page 50)
4. The search can be restricted by the Auto Delete function. Refer to "Setting the Recording > Record Option". (Page 56)



- Overlapped data : It only appears if there exists overlapped data on a certain time, produced due to the change of DVR's time setup. The latest data comes first, from <List0>. It does not appear in <Backup Search>.

Time Search

You can search for recorded data of a desired time. As the time to display may be different depending on the time zone and the DST standard time, the time of data recorded in the same time can be displayed differently depending on time zone and DST settings.

Using the mouse may help easy setup.

4. Select <Time Search> in the <Search> menu.
5. Select a date to search.
 - Refer to "Using the Calendar". (Page 37)
6. The record data on the specific date will be listed. The display bar is different according to the data type. So check the data type for the color in the left pane.
7. Use direction buttons (▲▼◀▶) to set the search criteria and press the [ENTER] button.

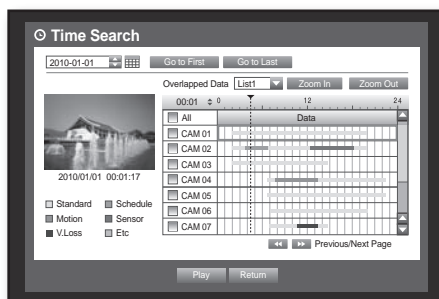

- Go to First : Moves to the earliest date.
- Go to Last : Moves to the most recent date.
- Time : Enter a time to perform the search or use the up/down button <▲▼> to select one.

- **Zoom In** : The map enlarges in detail.
It will switch in the sequence of 24 hours - 4 hours - 1 hour - 5 minutes.
- **Zoom Out** : The map will switch in the reverse order of the detailed mode above.
It will switch in the sequence of 5 minutes - 1 hour - 4 hours - 24 hours.



▪ Double-click a desired time to zoom it in/out.

- **Preview** : Click <Channel> and select (click, drag) a time in <Duration> to display a still image for the portion.
 - If the selected channel does not contain any recorded data, it will be marked black.
8. Select a data item and click <Play>.
The screen switches to the data playback mode.

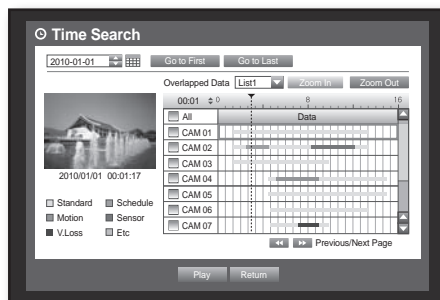

Event Search

You can search for events by the channel and play them.
Using the mouse may help easy setup.

4. Select <Event Search> in the <Search> menu.
 5. Use direction buttons (▲▼◀▶) to set the search criteria and press the [ENTER] button.
 - All record events on a specific date will be found. (Normal/Schedule recording included)
 - **Date/Time Preview** : If you select a data item in the list, the still image of the selected data will be displayed in the left preview pane.
 - **Event** : Displays the type of the event that occurred.
6. Select a data item and click <Play>.
The screen switches to the event data playback mode.

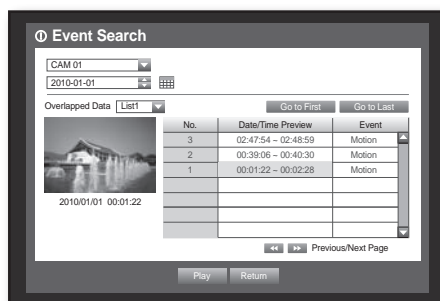

Backup Search

Searches for backup data in the connected backup device.
Only data in the format of DVR is included in the search.
Refer to <Type> in "Backup > Setting the Backup". (Page 60)
Using the mouse may help easy setup.

4. Select <Backup Search> in the <Search> menu.
 5. Use direction buttons (▲▼◀▶) to set the search criteria and press the [ENTER] button.
 - **Record Period** : Displays the record period.
 - **Channel** : Displays the recorded channel.
 - **Play Start Time** : Select a time that you start playing.
6. Select a data item and click <Play>.
The screen switches to the backup data playback mode.

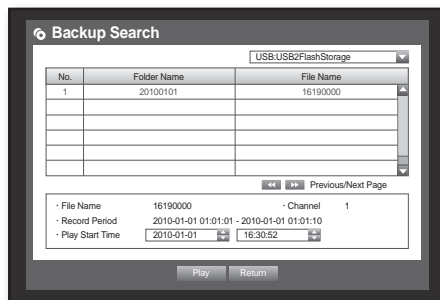

search & play

POS Search

You can search for data in the POS device that is connected to the DVR.

You can use the mouse to select the related items.

4. Select **<POS Search>** in the **<Search>** menu.
5. Use direction buttons (▲▼◀▶) to set the search criteria and press the **[ENTER]** button.
 - You can enter specific text to refine your search.
- **Keyword** : Use the virtual keyboard to enter a keyword.
- **Search Criteria** :
 - **<Case Sensitive>** : If selected, search will be performed case-sensitively.
 - **<Whole Word>** : If selected, only the exact matches with the keyword will be found.
- **Preview** : Select a data item in the list to display the preview image. Information about the image will be displayed on the bottom of the screen.
- **<II> <II>** : You can use these buttons to accelerate your search if you have a huge list of search results.
6. Select a data item and click **<Play>**.
The screen switches to the POS data playback mode.

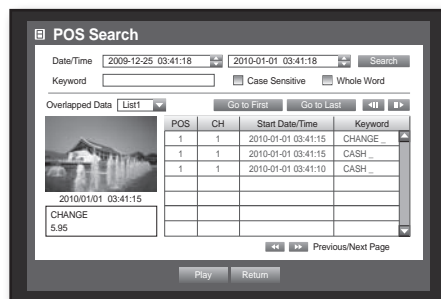

Motion Search

If a motion is detected in each channel, you can set a desired area to perform the search.

You can use the mouse to select the related items.

4. Select **<Motion Search>** in the **<Search>** menu.
5. Use direction buttons (▲▼◀▶) to set the search criteria and press the **[ENTER]** button.
 - If you set the motion area to **<Manual Area>**, the **<Setup>** button will be activated.
- **Motion Region** : Select an area to perform the search.
 - **All Area** : Searches for all areas of the selected channel.
 - **Current Area** : Searches for the motion area for each channel specified in **"Motion Detection > Setting the Motion Detection Area"**. (Page 58)
 - **Manual Area** : You can set the motion area manually.
- **Setup** : The Setup button will be activated only if you have set the motion area to Manual. Press this button to display the area setting window.
- **Date/Time** : The Date/Time will be automatically set by the hour, and the end time will be automatically set to one hour later than the start time if it is set.
- **Preview** : Select a data item in the list to display the still image of the item.
6. Select a data item and click **<Play>**.
The screen switches to the motion data playback mode.

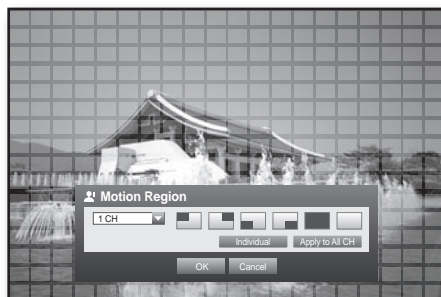
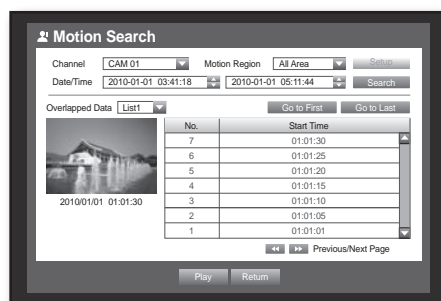

PLAYBACK

Play

You can play data stored in the HDD and backup a desired portion of the data.

Using the mouse may help easy setup.

1. In Live mode, click **<Play>** in the right-click menu or **<▶>** in the launcher menu, or press the Play button on the remote control or the front panel.
2. Use the up/down button (**▲▼**) to select a menu.
 - For data search, refer to **<Search>**. (Page 70)



3. Select a data item and click **<Play>** in the Search menu. The selected data is played and the play launcher appears on the screen.
 - If there is an existing data, **<Play>** will start immediately without performing the search.



- **▶** : You can play up to 4 channels in real time.
 - In a split mode, the real time playback may not be supported, depending on the record quality, resolution and number of channels. And some frame rates may be supported.
- Playback Information : Displays the date and time of the current data in the top corner.
- Mode Switch : Select a desired play mode or press the **[MODE]** button to switch the mode in the sequence of 1-split, 4-split, 9-split, 16-split and 13-split.
 - The grey area in the center of the 13-split mode plays the Live channel. The default channel of the Live mode is CH1, which can be changed later.
- **■** : Switches to Live mode.
- **● REC** : Records all channels in Live mode.
- Play Time : Displays the time and date of the current video.
- Play Bar : Displays the time of recorded data in the selected channel for the past 24 hours; the red gridline indicates the current play time.
- **📏** :
 - Speed : Supports various speed options of x1, x2(-2), x4(-4), x8(-8), x16(-16), x32(-32) and x64(-64).
 - Slow : Supports slow speed options of x1/2(-1/2), x1/4(-1/4) and x1/8(-1/8).

- Backup : Click **<🕒>** to set the current time to the start time of backup; you can specify a backup area using the mouse (yellow triangle). Click **<🕒>** again to set the current time to the end time of the backup and the **"Backup Range"** window appears.
 - Type : Supports formats of DVR, AVI and SEC. Refer to a list of formats in **"Setting the Backup"**. (Page 60)
 - Device : Select a backup device.
 - Check Capacity : Enables you to check the capacity of the selected storage device.

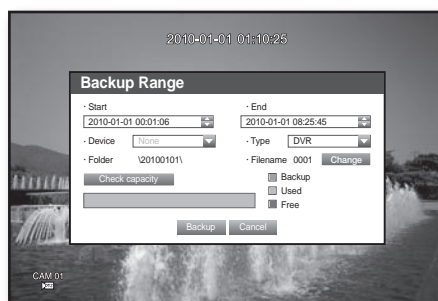

4. If you want to return to the Live screen in Play mode, click **<■>** in the launcher menu or press the **[■]** button on the remote control or the front panel.

web viewer

INTRODUCING WEB VIEWER

What is Web Viewer?

Web Viewer allows remote access to your DVRs. You have access to live video, archived video, PTZ control (if configured), etc.

PRODUCT FEATURES

- Remote access from a standard browser
- Supports PTZ camera controls
- Supports 1, 4, 8, 16 camera viewing formats (maximum of 16 cameras in the list).
- Gets JPEG format images to print and save to “Print or Save JPEG format images”.
- Record video in AVI format-compatible with popular media players. (needed the Xvid codec)

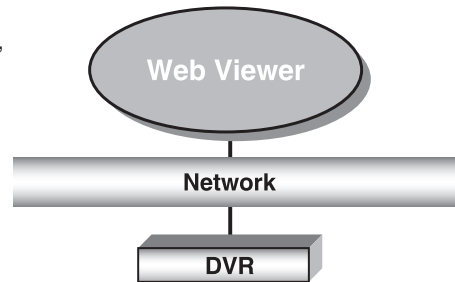

SYSTEM REQUIREMENTS

The following lists the minimum suggested hardware and operating system requirements needed to run the Web Viewer.

OS	Windows XP Professional Windows 2000 Windows Vista Home Basic /Premium Windows 7
Web Browser	Internet Explorer 6.0.2900.2180 or higher
CPU	Intel Pentium 4. 2 GHz
Memory	512 MB
Monitor	High Color 16-bit 1024 x 768
HDD	50 MB(Installation space required) * Additional HDD space required for recording. Recorded file size will vary depending on recording quality settings.

CONNECTING WEB VIEWER

1. Open your web browser and type the IP address or URL of DVR into the URL address box.



The basic URL of the DVR is as following in case of MAC address :

- 00-00-F0-ab-cd-ef : nabcdef.websamsung.net
- 00-16-6c-ab-cd-ef : mabcdef.websamsung.net
- 00-68-36-ab-cd-ef : pabcdef.websamsung.net
- You can also use registered URL which setups up in the Setup menu of your DVR.

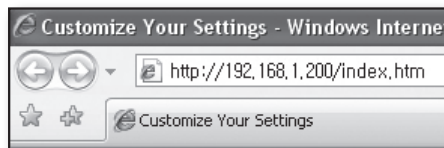

2. Set the Admin ID and password same to those of the DVR Admin.
For general users, enter the DVR user ID and password.



- It allows up to 10 simultaneous access including the Admin and general users.
- It does not allow multiple login of the Admin user.
- Initial password of the Admin user is set to "4321".
- Password of the Admin and general users can be changed in <Permission Management> menu of the DVR.
- Normal users should have set <Viewer> under <Permission Management> to "Use" before connecting to the Web Viewer. (Page 41)
- All settings are applied by the DVR's settings.

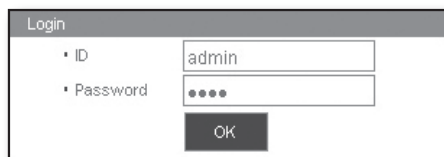

3. Click <Install ActiveX Control...>.

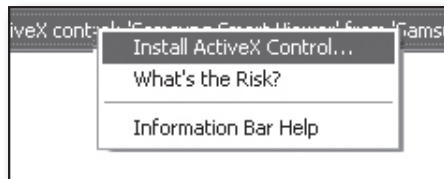

4. Click <Install>.



5. Click <Install>.



web viewer

6. You may have “**Windows Security Alert**” that attempts to block this with the Windows Firewall. In that case, click <**Unblock**> to start Web Viewer.



7. Installation is complete.
Now you can see the main screen of Live Viewer.



USING LIVE VIEWER

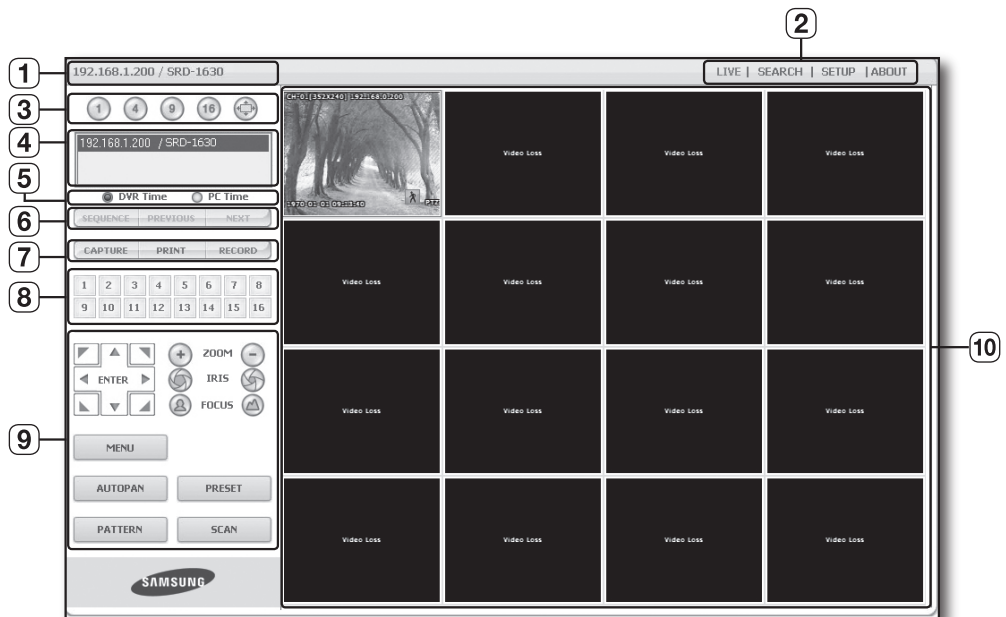

The Live Viewer screen consists of following :

- ① This displays the IP address and the model name of the connected DVR.
 - ② These menus consist of <LIVE>, <SEARCH>, <SETUP>, <ABOUT>.
 - ③ These buttons are used for the screen split and full screen mode.
 - ④ Shows the IP address and model name of the connected DVR.
 - ⑤ Select <DVR Time> or <PC Time> for the OSD time information display setting of the Live Viewer.
 - ⑥ These buttons are used for sequence and changing the screen channel.
 - ⑦ These buttons are used for capture, print, and save the image.
 - ⑧ Shows the channel of the connected DVR.
 - ⑨ These buttons are used for PTZ related functions.
 - ⑩ This displays the screen for connected camera with DVR.
- ✍ The resolution is set to 1024X768 pixels.
 - ✍ The initial split-screen mode is set according to the number of channels connected to DVR. You can change the split-screen mode by clicking buttons for split-screen modes.

web viewer

OSD INFORMATION DISPLAY

- ① The channel number, video size, and IP address of the connected DVR are displayed.
- ② The current date and time will be displayed according to the selected time information display setting <DVR Time> or <PC Time>.
- ③ Alarm icon appears when alarm is issued. It disappears when pressed the [ALARM] button of the DVR.
- ④ Motion icon appears when motion is detected. It disappears when pressed the [ALARM] button of the DVR.
- ⑤ It displays whether the PTZ controls are active.

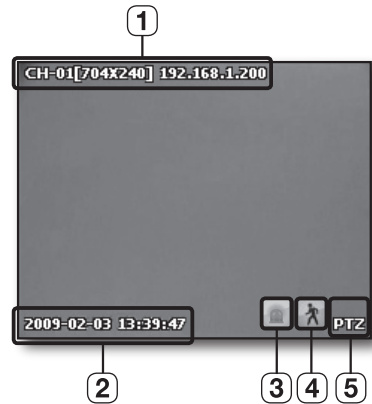

- If you have set PTZ cameras for the DVR, "PTZ" is displayed on the screen. Select a PTZ camera channel and use the [PTZ] button for camera control.

SPLIT-SCREEN

You can change the split mode by clicking each number icon.



SINGLE MODE



QUAD MODE



NINE MODE



SIXTEEN MODE

- Click <①> button.
The screen displays the selected camera connected to the DVR in "SINGLE MODE".
- Click <④> button.
The screen displays the selected camera connected to the DVR in "QUAD MODE".
- Click <⑨> button.
The screen displays the selected camera connected to the DVR in "NINE MODE".
- Click <⑯> button.
The screen displays the selected camera connected to the DVR in "SIXTEEN MODE".
- Click <⊕> button.
The screen displays the selected camera connected to the DVR in "FULL SCREEN MODE".
Double clicking on the screen or pressing any button of the keyboard returns to the previous mode.

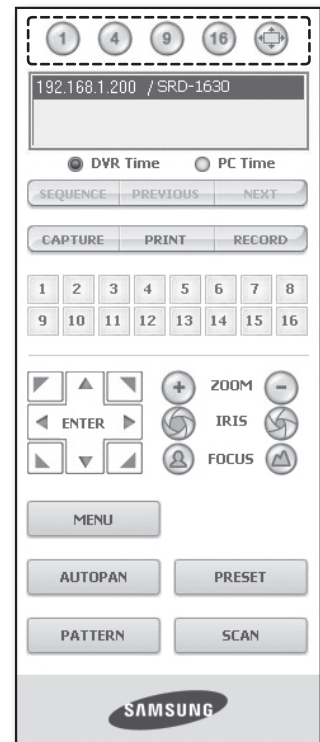

CONNECTED DVR

This displays the IP address and the status of the connecting DVR.



- Connection failure message
 - No Response** : Appears when the DVR does not respond.
 - Access Denied** : Appears when the maximum number of users is exceeded.
- The number of simultaneous connections are limited to 10.

Setting the display of the OSD time information

Select <DVR Time> or <PC Time> for the OSD time information display setting.

- **DVR Time** : Based on the time of the connected DVR
- **PC Time** : Based on the time of the PC currently running the Web Viewer.



CHANGING THE LIVE SCREEN MODE

- 16-split mode does not support "SEQUENCE", "PREVIOUS" and "NEXT".
- **SEQUENCE** : When this button is clicked, screens are switched at a preset interval.
 - In SINGLE MODE, the channel numbers are sequentially switched from 1 to 16.
 - In QUAD MODE, the screens are changed like 1st 4 channels (1~4) → 2nd 4 channels (5~8) → 3rd 4 channels (9~12) → 4th 4 channels (13~16).
 - In NINE MODE, the screens are changed from 9 channels (1~9) to 7 channels (10~16).
 - In SIXTEEN MODE, the screen refreshes at the preset interval.
 - Preset interval (10 seconds)
- **PREVIOUS** : When this button is clicked, the previous screen appears.
 - In SINGLE MODE, the channel numbers are switched in reverse order.
 - In QUAD MODE, the screens are changed like 1st 4 channels (1~4) → 2nd 4 channels (13~16) → 3rd 4 channels (9~12) → 4th 4 channels (5~8).
 - In NINE MODE, the screens are changed from 9 channels (1~9) to 7 channels (10~16).
 - In SIXTEEN MODE, the screen is refreshed.

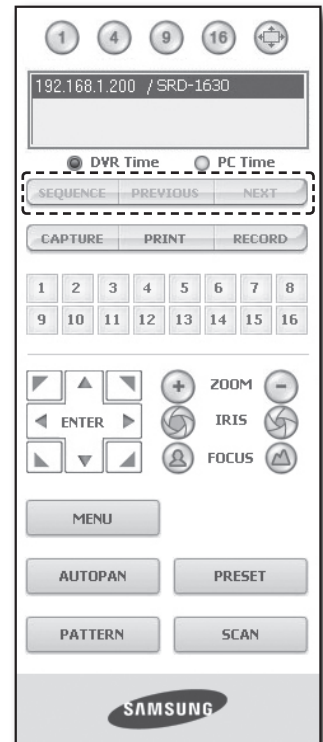

web viewer

- **NEXT** : When this button is clicked, the next screen appears.
 In SINGLE MODE, the channel numbers are sequentially switched from 1 to 16.
 In QUAD MODE, the screens are changed like 1st 4 channels (1~4) → 2nd 4 channels (5~8)
 → 3rd 4 channels (9~12) → 4th 4 channels (13~16).
 In NINE MODE, the screens are changed from 9 channels (1~9) to 7 channels (10~16).
 In SIXTEEN MODE, the screen is refreshed.
 - If 16-channel DVR is connected, clicking “NEXT” in QUAD MODE is to change the screen as shown in the picture.

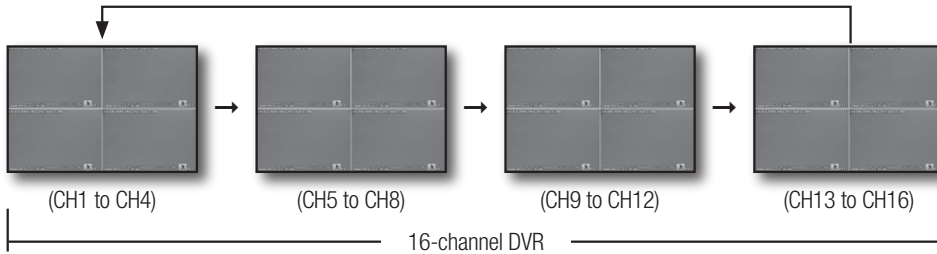

SAVING THE LIVE SCREEN ON THE PC

- **CAPTURE** : Saves the current screen into a BMP or JPEG file.



- The default saving path is “C:\Program Files\Samsung\Dvr Web Viewer\SnapShot\Live”. To change the saving path, click <SAVE PATH (...)> button and then select the path you want. For Windows Vista or 7, the saving path is “C:\users\ (user ID)\AppData\LocalLow\Samsung\DVR Web Viewer\SnapShot\” by default, which cannot be modified.
- The file is automatically named as following : “IP address_Port number_YYYYMMDD_camera number_index”
 Ex) 192.168.1.200_554_20080903_134132_01_00

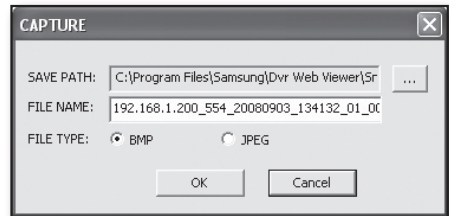

- **PRINT** : Prints out the selected screen out of the currently displayed live screens. It also prints the IP address, time, camera number and the current event status together.

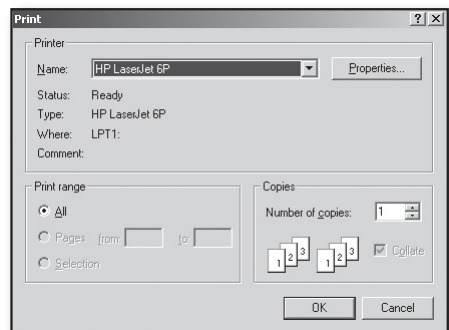

- **RECORD** : Saves the current image on the screen and saves it as a avi video file.



- To record it, it is required at least 1GB of available space.
- The default saving path is "C:\Program Files\Samsung\Dvr Web Viewer\VideoClip\Live". To change the saving path, click <SAVE PATH (...)> button and then select the path you want. For Windows Vista or 7, the saving path is "C:\users\
(user ID)\AppData\Local-Low\Samsung\DVR Web Viewer\VideoClip\" and it cannot be modified.
- The file is automatically named as following : "IP address_Port number_YYYYMMDD_camera number_index"
Ex) 192.168.1.200_554_20080903_135105_01_00
- For AVI Save, you need the Xvid codec for playing saved files.
- HDD Minimum Free Size : During the recording, if there is no more capacity available in the HDD than set free space will prompt with a popup message : "**Cannot record due to insufficient disc space in the HDD**".

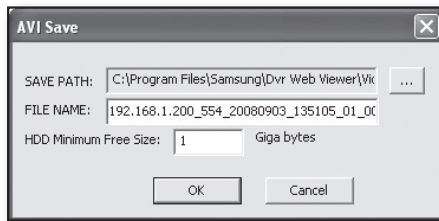

CHANGING THE LIVE SCREEN CHANNEL

- Blue numbers : Indicates that the current channel is connected to a camera.
- Gray numbers : Indicates that the current channel is not connected to any camera.



USING PTZ CAMERA

Click the direction buttons to control the camera.

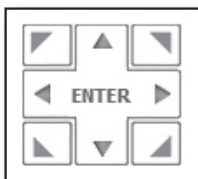

- < (+) ZOOM (-) >

You can zoom in or out an image by using the ZOOM button.

- < (IRIS) (IRIS) >

You can adjust the entering light amount by using the IRIS button.

- < (FOCUS) (FOCUS) >

You can adjust the focus by using the FOCUS button.

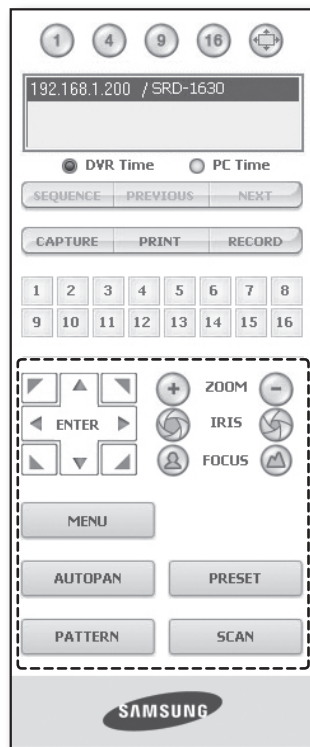

web viewer

- **MENU** : Appears the camera menu screen.



- **PRESET** : Moves the lens direction to a preset direction.

1. If you click a preset, the camera moves to the selected preset's position.
2. You can delete the selected preset or all presets.
3. You can save a new preset number and name.



- You can save presets up to 20.

- **AUTOPAN** : Moves the camera lens direction between 2 points set for the camera.
- **SCAN** : Moves the camera lens direction between 2 preset points of the camera.
- **PATTERN** : You can set camera various movement patterns such as zoom, move, etc. so that a camera automatically moves according to the pattern.



- While the DVR controls a PTZ camera, Web Viewer cannot control the camera.
- Camera menu setup is only available for camera supporting the function.
- Each function of PTZ is same to that of the DVR.
- Pan/Tilt of the Smart dome camera is manipulated automatically to center the camera to the mouse clicked point.
- If you drag the mouse using the left button on a certain point, Pan/Tilt of the Smart dome camera is manipulated automatically to center the camera to the middle point between the dragging start and end position. Upward dragging will zoom out, while downward dragging will zoom in.
- Tilt of Power PTZ operates properly within 45°.
- Power and Pan Tilt functions are only available for camera supporting the functions.
Ex : Samsung SCC-C6475



USING SEARCH VIEWER

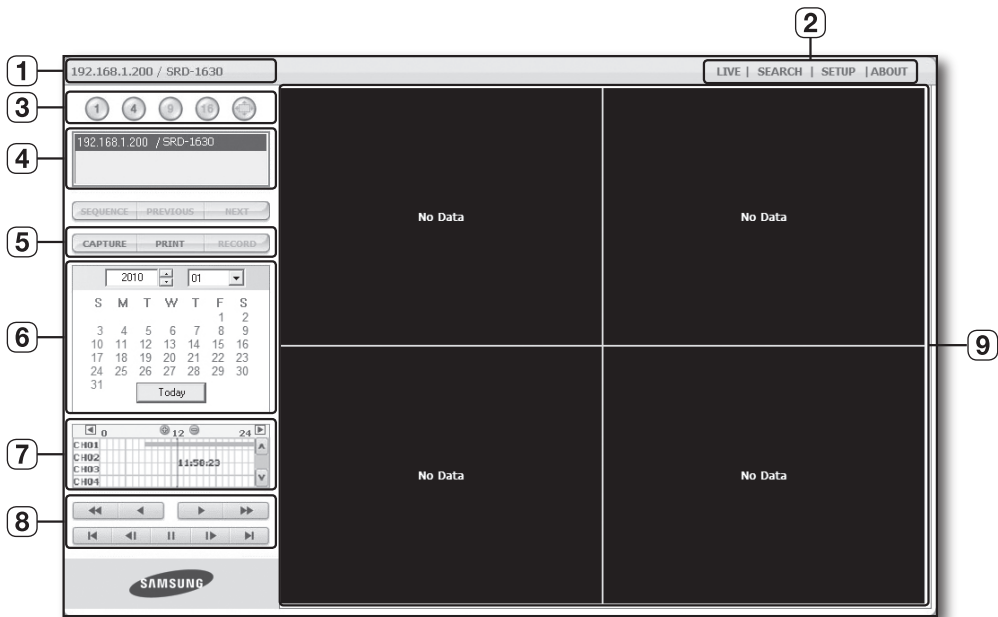

The Search Viewer screen consists of following :

- ① This displays the IP address and the model name of the connected DVR.
- ② These menus consist of <LIVE>, <SEARCH>, <SETUP>, <ABOUT>.
- ③ These buttons are used for the screen split and full screen mode.
- ④ Shows the IP address and model name of the connected DVR.
- ⑤ These buttons are used for capture, print, and save the image.
- ⑥ This displays a calendar at which you can search the recorded video.
- ⑦ This displays a timeline at which you can search the recorded video by the time.
- ⑧ These buttons are used for controlling playback.
- ⑨ This displays the screen for playback of recorded video.

 ▪ <SEQUENCE>, <PREVIOUS>, <NEXT> buttons are not available in SEARCH menu.

web viewer

SPLIT-SCREEN

You can change the split mode by clicking each number icon.



SINGLE MODE



QUAD MODE

- Click < 1 > button.
The screen displays the selected camera connected to the DVR in “**SINGLE MODE**”.
 - Click < 4 > button.
The screen displays the selected camera connected to the DVR in “**QUAD MODE**”.
-  Only SINGLE and QUAD MODE are available in SEARCH menu.
- If 16 channel DVR is connected, you can select a mode from SINGLE to SIXTEEN MODE.

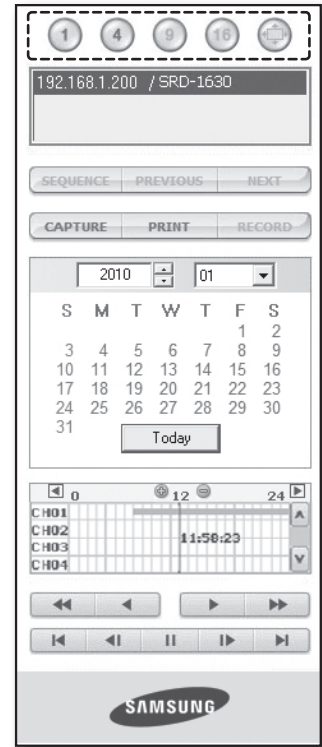

CONNECTED DVR

This displays the IP address and the status of the connecting DVR.

-  Connection failure message
- **No Response** : Appears when the DVR does not respond.
 - **Access Denied** : Appears when the maximum number of users is exceeded.
 - The number of simultaneous connection is limited to 3.

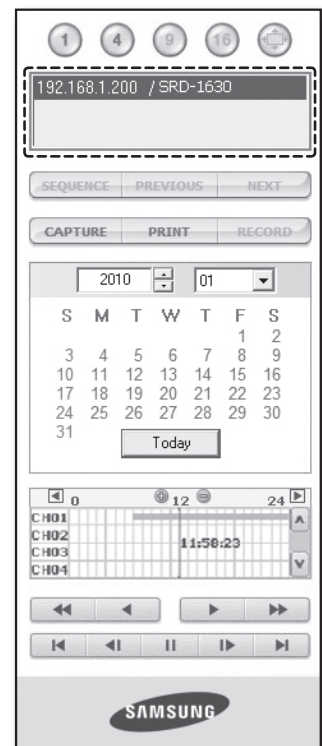

SAVING THE LIVE SCREEN ON THE PC

- **CAPTURE** : Saves the current screen into a BMP or JPEG file.



- The default saving path is "C:\Program Files\Samsung\Dvr Web Viewer\SnapShot\Search". To change the saving path, click <SAVE PATH (...)> button and then select the path you want. For Windows Vista or 7, the saving path is "C:\users\user ID\AppData\LocalLow\Samsung\DVR Web Viewer\SnapShot\" and it cannot be modified.
- The file is automatically named as following : "IP address_Port number_YYYYMMDD_camera number_index"
Ex) 192.168.1.200_554_20080903_134132_01_00

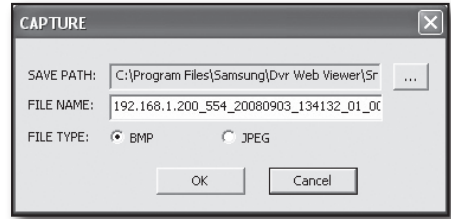

- **PRINT** : Prints the playback screen that is now being displayed. It also prints IP address, time, camera number, and current event state.

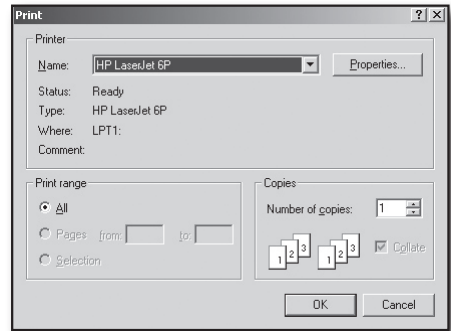

- **RECORD** : If you select a channel and click this button during playback (only play), the video data is saved in a DVR file. (It is saved in the designated folder on your PC.)
To stop recording, click this button again.



- To record it, it is required at least 1GB of available space.
- The default saving path is "C:\Program Files\Samsung\Dvr Web Viewer\VideoClip\Search". To change the saving path, click <SAVE PATH (...)> button and then select the path you want. For Windows Vista or 7, the saving path is "C:\users\user ID\AppData\LocalLow\Samsung\DVR Web Viewer\Video-Clip\" and it cannot be modified.
- The file is automatically named as following : "IP address_Port number_YYYYMMDD_camera number_index"
Ex) 192.168.1.200_554_20080903_135105_01_00
- For AVI save, you need the Xvid codec for playing saved files.

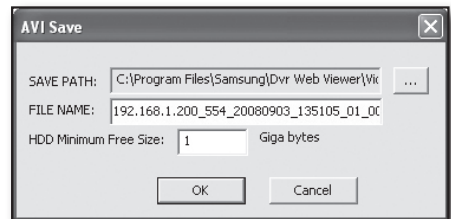

SEARCHING THE RECORDED VIDEO IN THE CALENDAR

If the video data has been recorded on a date, the date is distinguished in green. If you click the date, the recorded video information is displayed in the time line. When you click <Today>, it is changed to today's date.

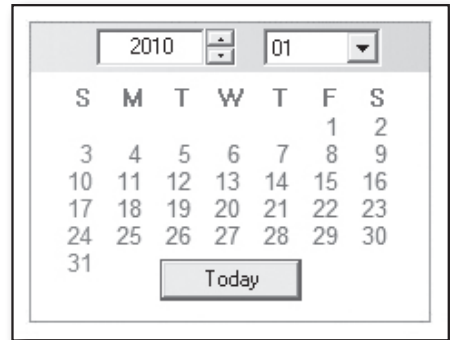

SEARCHING THE RECORDED VIDEO IN THE TIMELINE

It displays the recorded video data status on the DVR after a date is selected. The normal mode displays the time ranging from 0 to 24 Hours while the extension mode displays the time every 2 hours.

[Normal Mode]

- If you click <⊕> button, it changes to the extension mode.
- Each time line represents 1 hour.

[Extension Mode]

- If you click <⊖> button, it changes to the normal mode.
- Each time line represents 5 minutes.

 ■ The channels are ranging from CH01 to CH16.

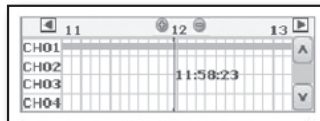
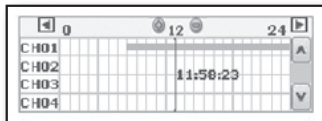

CONTROLLING PLAYBACK

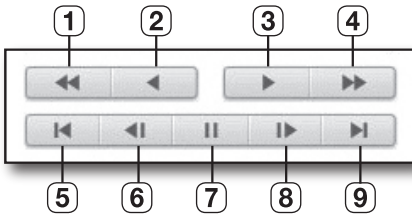

- ① **Fast Backward** : Reverse-plays faster(2x).
- ② **Reverse Play** : Performs Reverse Play.
- ③ **Play** : Performs playback.
- ④ **Fast Forward** : Plays faster(2x).
- ⑤ **Go to First** : Moves the beginning time of recorded video in the time line.
- ⑥ **Step Backward** : Performs one step reverseplay by one frame.
- ⑦ **Stop** : Stops playing.
- ⑧ **Step Forward** : Performs one step forward by one frame.
- ⑨ **Go to Last** : Moves the last time of recorded video in the time line.



VIEWER SETUP

You can configure the DVR settings remotely on the network.

To configure the DVR settings, click <Setup>.

System

You can configure the various settings of the DVR system.

Date/Time/Language

For more information, refer to <Date/Time/Language> in the <System Setup> menu. (Page 36)

1. Select <Date/Time/Language> in the System menu.
2. Configure the DVR settings according to your system environment.

• Date/Time

Set the date and time.

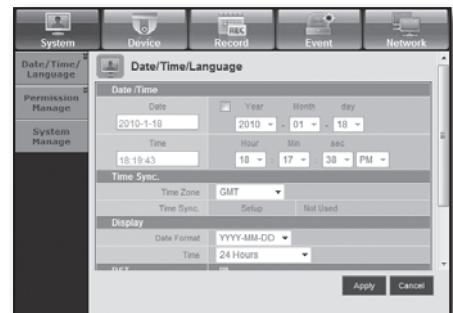

web viewer

- **Time Synchronization Setup**

Set the time synchronization.

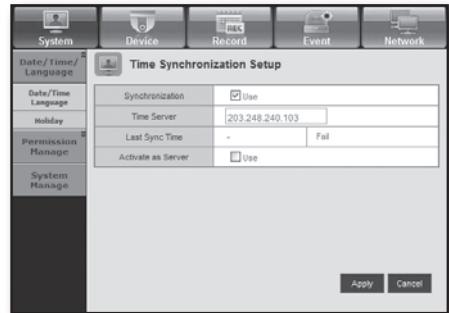

- **Display**

Date Format : Set the date type.

Time : Select a time format to display on the screen.

- **DST (Daylight Saving Time)**

DST is displayed an hour ahead of the standard time of the time zone.

- **Language**

Select a preferred language for the DVR.



Holiday

You can set specific dates to Holidays according to your preferences.

For more information, refer to <Setting Holiday> in the <System Setup> menu. (Page 37)

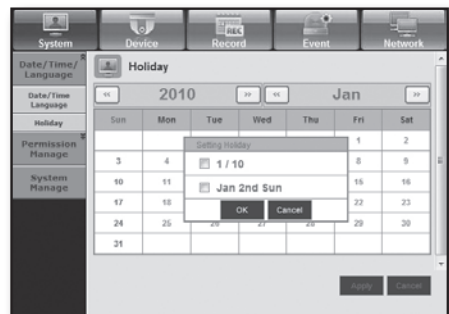

Permission Management

For more information, refer to <Permission Management> in the <System Setup> menu. (Page 38)

- **Admin**

You can change the admin ID or the password.

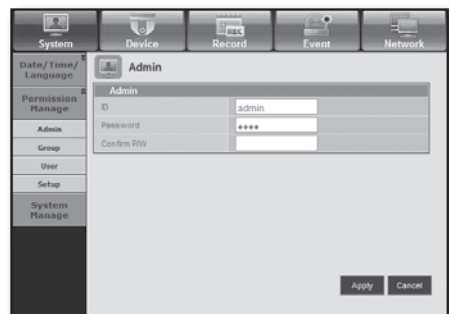

• **Group**

Users are classified into the group and the permission can be set according to the group.

- First of all, add a group.

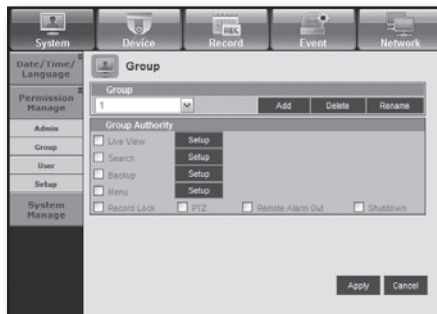

• **User**

You can add, change or remove a user or users.

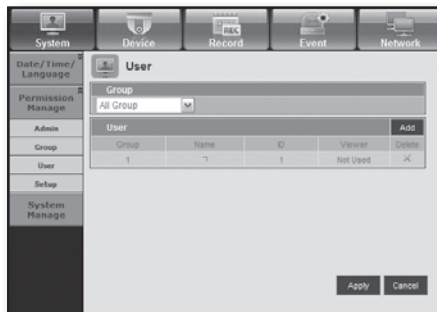

• **Setup**

You can set the user permission.

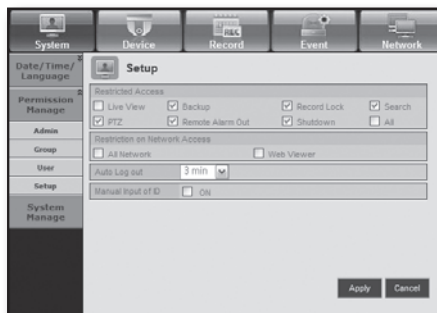

System Management

For more information, refer to <System Management> in the <System Setup> menu. (Page 42)

• **System Information**

You can see information of the current system. Check the software version, broadcast format and MAC address.

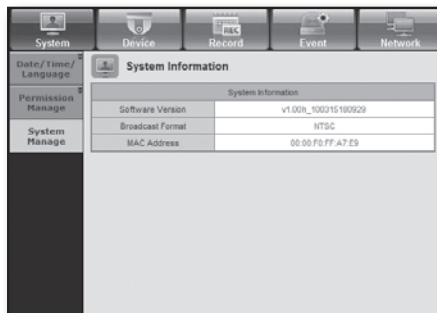

web viewer

Device

You can check a list of devices that are connected to the DVR and configure the necessary settings.

Click <Device> in the menu screen.

For more information, refer to "Setting the Device". (Page 46)

Camera

• Camera

You can configure the settings of the camera that is connected to the DVR.



- SRD-830/830D/1610/1610D/1630/1630D supports 1~4 channels of sound inputs.



• PTZ

You can configure the settings of the PTZ camera that is connected to the DVR.

Set the ID and protocol.

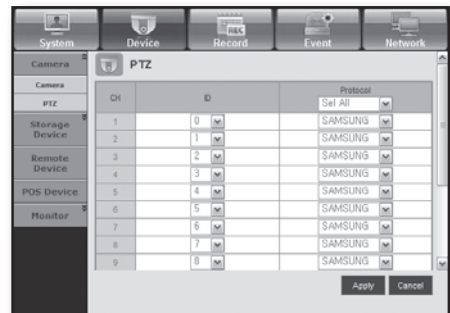

Storage Device

You can check and change the settings of the storage device.

• Device

You will see a list of storage devices that are connected to the DVR.

You can check the type, used/total, usage and status of the device.

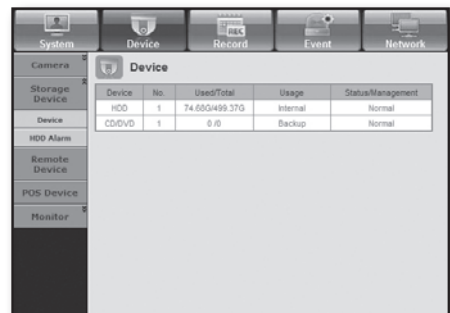

- **HDD Alarm**

You can set the alarm output channel and the alarm duration for an error.

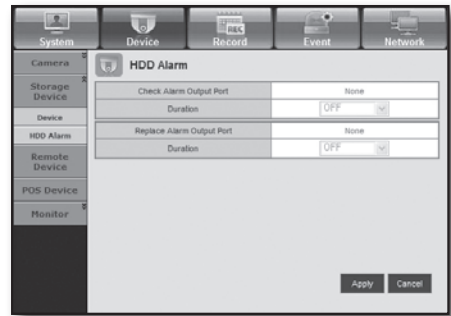

Remote Device

You can see a list of remote devices including PTZ cameras and system keyboards that are connected to the RS-485 port of the DVR and configure the necessary settings.

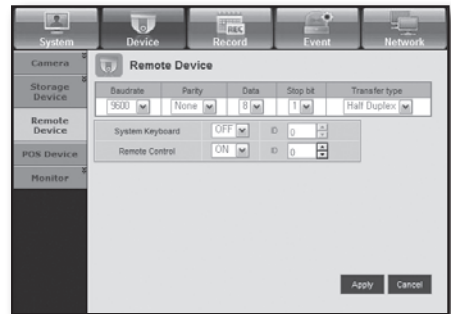

POS Device

You can set the channel, preset and communication port of the POS device that is connected to the DVR.



- You cannot set to use the POS device remotely.



Monitor

- **Monitor**

You can configure the monitoring screen settings and set the output system.



- SRD-830/830D/1610/1610D/1630/1630D does not support the HDMI signal.



web viewer

• Spot Out

The registered user can view the event screen for the duration set in **<Event Display>** if an event occurs from the appropriate channel.



- The number of Spot Out terminals differs according to the model.

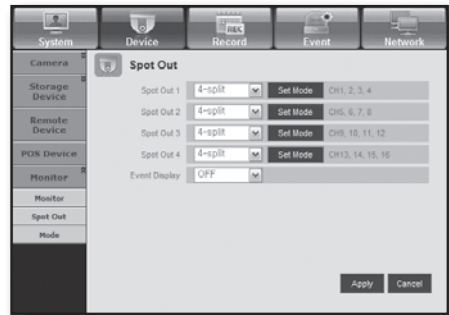

• Mode

You can switch between live mode and play mode.

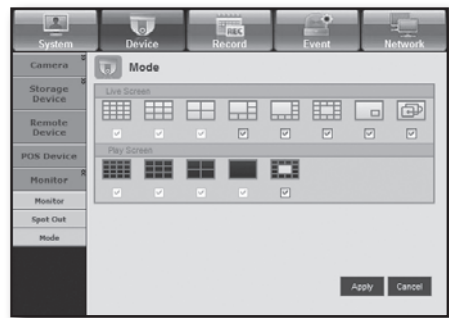

Record

For more information, refer to **<Setting the Recording>**. (Page 54)

Recording Schedule

If you set a recording schedule for a specific date and time, the recording will start at that specific time.

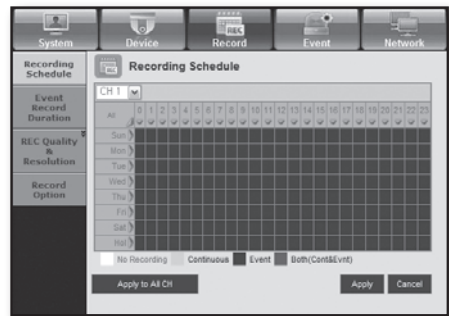

- Apply to All CH : Click **<Apply to All CH>** to display the confirmation window.

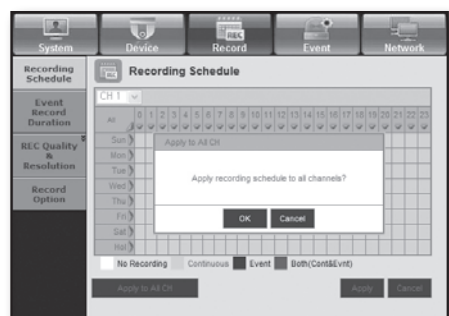

Event Record Duration

You can set the start and end times of recording that will be activated if an event occurs.



REC Quality & Resolution

• Standard/Event

You can set the resolution, frame rate and recording quality for each channel.

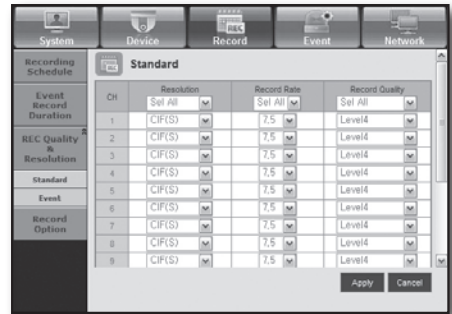

Record Option

You can set the Disk End Mode.

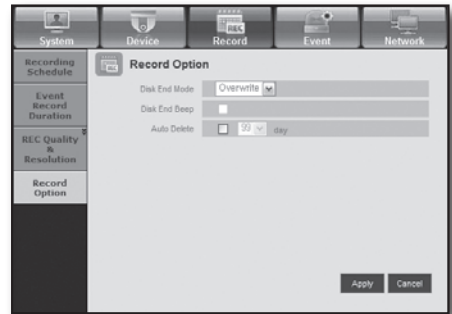

Event

For more information, refer to <Setting the Event>. (Page 57)

Sensor Detection

You can set the sensor operation mode and the synchronized camera as well as the alarm output type and the duration.

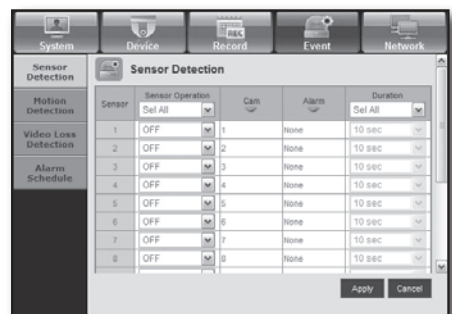

Motion Detection

You can set the motion detection mode and the sensitivity as well as the alarm output type and the duration.

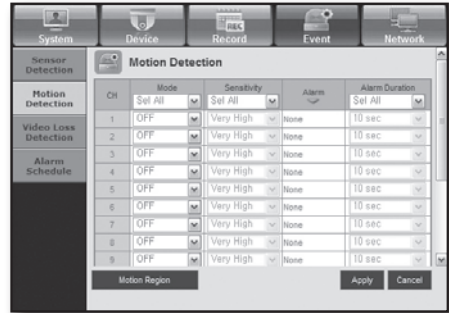

- **Motion Region**

Set the target motion detection area

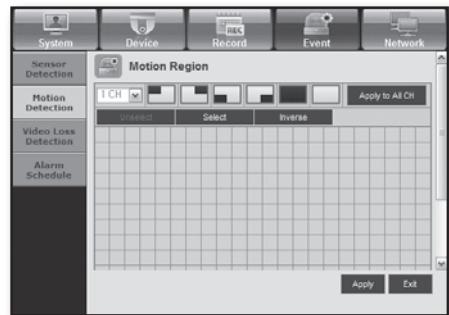

Video Loss Detection

You can set the alarm output time if a video loss occurs.

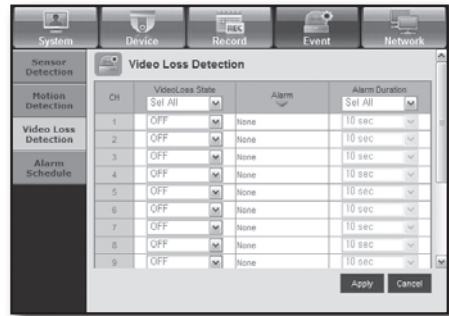

Alarm Schedule

You can schedule the alarm output according to the day of the week and the time. The default setting is Event Sync, which activates the alarm only if an event occurs.

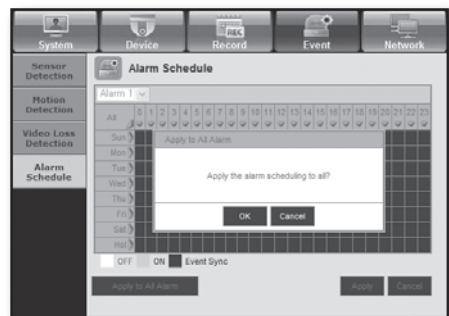

Network

For more information, refer to <Network Configuration>. (Page 61)

Connection

A remote user can access the DVR via the network to check the current mode and the IP address.

- **Connection**

You can set the network connection route.

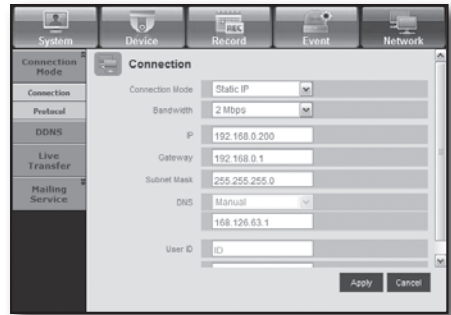

- **Protocol**

You can configure the protocol related settings.

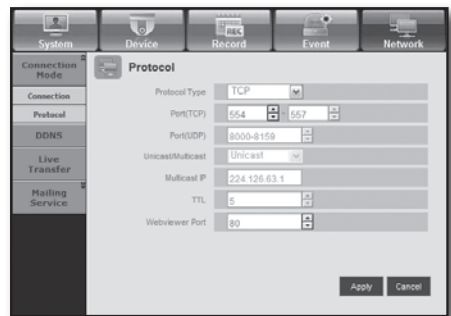

DDNS

You can check the DDNS settings.

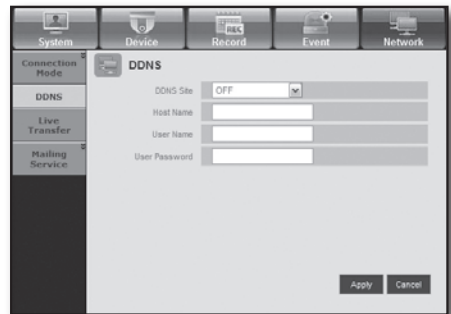

Live Transfer

A remote user can set the images of the DVR.

- **Live Transfer**

A remote user can set the image resolution of the transferred data.

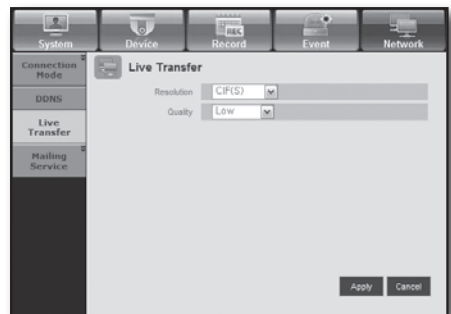

web viewer

Mailing Service

You can specify the SMTP server that sends a mail if an event occurs and set the recipient group and users.

- **SMTP**

You can set the server that sends mails and specify if you use the authentication process.

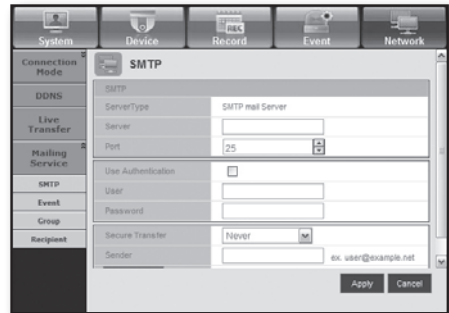

- **Event**

You can set the event interval and specify which events the server sends mails for.

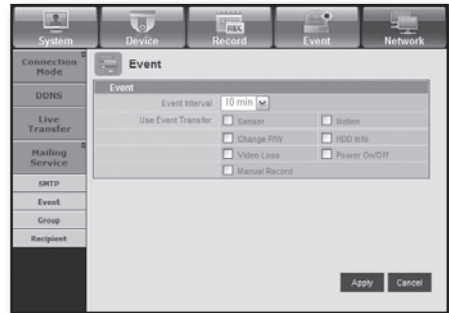

- **Group**

You can add a group to receive the mail if an event occurs and set the permission to receive the event mail for each group.

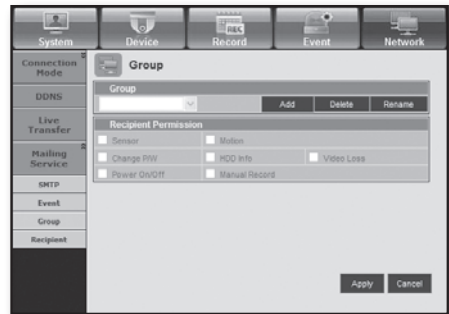

- **Recipient**

You can add a user or users who will receive the mail.

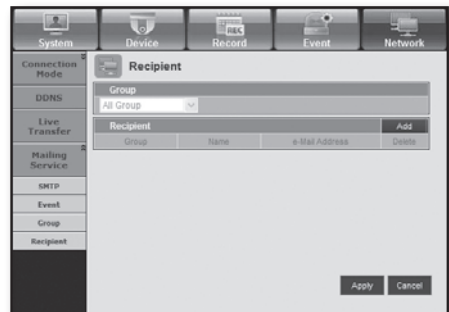

ABOUT

Click <ABOUT>.

Displays the model name of connected DVR and the version of Web Viewer.



backup viewer

SEC BACKUP VIEWER

You can play a file that is backed up in the format of SEC.

Backup in the format of SEC will involve in generating two files: one for the backup data and one for the viewer.















If you run the backup file viewer, the backup data file will be automatically played.



Recommended System Requirements

PCs with a lower specification than the recommended below may not fully support forward/backward and high-speed playback.

- OS : Windows XP professional, Windows Vista, Windows 7
- CPU : Intel Core2-Duo 2.4GHz or higher
- RAM : DDR PC-3200 1G or more
- VGA : Geforce 6200 or higher

Name		Description
1	Audio	 /  A toggle button. Each time you press this button, the audio output will toggle between activated and deactivated.
		 You can adjust the volume level from 0 to 100.
2	Screen Printout	 Saves the current screen as an image file. Supported file formats include BMP and JPEG.
		 Prints out the current screen. You should have installed the appropriate printer driver before you can print out the screen.
3	File Tamper Detection	 /  A toggle button. Each time you press this button, it will toggle between activated and deactivated. The closed lock icon indicates activation of the file tamper detection, which will blink the screen three times and stop playing if an unauthorized manipulation of a data file is detected. <ul style="list-style-type: none"> ▪ A message of "The file is forged" will display in the menu bar.
4	Zoom In/Out	 Collapses the time range that is displayed on the range bar of the storage time. You can collapse the range bar until the overall range is shortened to 24 hours.
		 Enlarges the time range that is displayed on the range bar of the storage time. You can enlarge the range bar until the overall range is extended to 1 minute.
5	Display of storage time range	Displays the time range of a stored video file. You can move the gridline of the range bar to select a time point to play.
6	Speed	 A toggle button; each time you press this button, the "Slow Playback" icon changes its color to display it's activated/deactivated. If it is activated, you can use the play speed control to adjust the play speed up to x1/32 forward and backward respectively, whereas if deactivated, you can adjust up to x32 forward and backward.
		 A toggle button; each time you press this button, the "Lock Speed" icon changes its color to display it's activated/deactivated. If activated, the adjusted speed will be kept even if you release the mouse on the speed bar. If deactivated, the adjusted speed will be applied only while you use the mouse to hold the adjusted speed, and if you release the mouse, the speed will restore to x1.
		 You can adjust the play speed up to x32 forward and backward respectively, which varies according to the frame rate per second of the source. If the frame rate per second is between 20 and 30, the maximum speed is limited to x4, if the FPS is between 11 and 19, it is limited to x16, and if the FPS is 6 or less, it supports up to x32.
7	Play	 Displays the next frame. This is available only if the playback is stopped.
		 A toggle button. Press it once to start playing the video and switch the button mode to 'Pause', and press it again to switch the button mode to Play and stop playing temporarily.
		 Displays the previous frame. This is available only if the playback is stopped.

appendix

PRODUCT SPECIFICATION (SRD-830/830D/1610/1610D/1630/1630D)

Item		Details	Note									
Operating System		Embedded OS										
Broadcast Format		NTSC/PAL System										
Input Voltage		AC 100~240V										
Power Consumption		SRD-830/830D/1610/1610D/1630/1630D : 55W										
Video	Video In	Composite 16(8) Channel - 1.0Vp-p - 75Ω Hi Z Termination BNC Type Loop Through Out 16(8) Channel - Auto Termination										
	Video Out	Composite 2 Channel - Normal Video Output 1 Channel - Spot Output 1 - BNC Type VGA 1 Channel										
Audio	Audio In	Mono 4 Channel 4 Channel : RCA Type - 5dBm, 600Ω										
	Audio Out	Mono 1 Channel - 6dBm RCA Type										
Live Screen	Resolution & Frame Rate	<table border="1"> <thead> <tr> <th></th> <th>NTSC</th> <th>PAL</th> </tr> </thead> <tbody> <tr> <td>Resolution</td> <td>704x480</td> <td>704x576</td> </tr> <tr> <td>Frame Rate</td> <td>480ips(16Ch)/ 240ips(8Ch)</td> <td>400ips(16Ch)/ 200ips(8Ch)</td> </tr> </tbody> </table>		NTSC	PAL	Resolution	704x480	704x576	Frame Rate	480ips(16Ch)/ 240ips(8Ch)	400ips(16Ch)/ 200ips(8Ch)	
			NTSC	PAL								
	Resolution	704x480	704x576									
Frame Rate	480ips(16Ch)/ 240ips(8Ch)	400ips(16Ch)/ 200ips(8Ch)										
Display Mode	Single Split Modes: 16CH : 4-, 6-, 8-, 9-, 13-, 16- splits 8CH : 4-, 6-, 8-, 9-, 13- splits PIP Mode sequence Freeze 2 X Zoom											

Item		Details			Note
Record	Compression Method	Video : H.264 Audio : G.723			
	Resolution & Quality	Resolution	Spec. (Quality)	Max Recording Rate	
		CIF(S) 352X240(NTSC) /352X288(PAL)	Level8 (high) ~ Level1 (low)	240(120)ips(NTSC)/ 200(100)ips(PAL)	SRD-1630/D (SRD-1610/D 830/D)
		Half D1(M) 704x240(NTSC) /704x288(PAL)	Level8 (high) ~ Level1 (low)	120(60)ips(NTSC)/ 100(50)ips(PAL)	SRD-1630/D (SRD-1610/D 830/D)
Full D1(L) 704x480(NTSC) /704x576(PAL)	Level8 (high) ~ Level1 (low)	60(30)ips(NTSC)/ 50(25)ips(PAL)	SRD-1630/D (SRD-1610/D 830/D)		
Record Mode	Normal Recording → REC button Scheduled Recording → Schedule Table Event Recording - Alarm Detection - Motion Detection - Video Loss - Pre & Post Recording				
Frame Rate	NTSC : 0.9, 1.9, 3.8, 7.5, 15, 30ips PAL : 0.8, 1.6, 3.1, 6.2, 12.5, 25ips				
Storage	Internal	SRD-830D/1610D/1630D : SATA HDDx5(MAX) MAX HDD size : 1TB x 5 = 5TB SRD-830/1610/1630 : SATA HDDx6(MAX) MAX HDD size : 1TB x 6 = 6TB			If you want to add an internal HDD, please refer to "Adding a HDD". (Page 16)
Play	Search Mode	Calendar Search Event Search - Alarm, Motion, Video Loss Time/Date Search Go to First Go to Last Backup Search Text Search(for POS) Motion Search Preview			
	Resolution & Specification	Resolution	Specification		
		CIF(S) 352X240(NTSC) /352X288(PAL)	240(120)ips(NTSC)/ 200(100)ips(PAL)		SRD-1630/D (SRD-1610/D 830/D)
		Half D1(M) 704x240(NTSC) /704x288(PAL)	120(60)ips(NTSC)/ 100(50)ips(PAL)		SRD-1630/D SRD-1610/D 830/D
		Full D1(L) 704x480(NTSC) /704x576(PAL)	60(30)ips(NTSC)/ 50(25)ips(PAL)		SRD-1630/D (SRD-1610/D 830/D)

appendix

Item		Details	Note
Play	Display Mode	Single /4-/9-/13-/16-splits	SRD-1610/ 1610D/1630/ 1630D
		Single /4-/9-/13-splits	SRD-830/830D
	Play Mode	Play, Pause, Stop, 2xDigital Zoom Fast Forward/Fast Reverse - 2x, 4x, 8x, 16x, 32x, 64x	
Backup		USB External HDD USB CD/DVD Writer, Internal DVD(SRD-830D/1610D/1630D only) USB Memory USB HDD-MAX 1(USB hub not supported)	
Network		Ethernet : 10/100/1000 BaseT, ADSL(PPPoE), DHCP	
Serial Communication		RS-485 → PTZ Device Control Remote Control Device RS-232C → POS	
Alarm		Input : SRD-1610/1610D/1630/1630D : 16 channels SRD-830/830D : 8 channels	
Remote Viewer	PC Requirements	CPU : Intel Core 2 Quad 2.5GHz or higher RAM : 2G VGA : 32M RAM(64M or more) DirectX 8.1	
	Operating Systems	Windows XP(Pro), Windows-2000(Pro) Windows Vista(Home Basic/Premium) Windows 7	
	Features	Live Image Monitoring Mode Local File Search & Play Back Mode Remote File Search & Play Back Mode	
Temperature (Operation)		0°C ~ 40°C (32°F ~ 104°F)	
Temperature (Storage)		-20°C ~ 60°C (-4°F ~ 140°F)	
Humidity (Operation)		20% to 85% RH	
Humidity (Storage)		20% to 85% RH	
Dimension (W x H x D)		440 x 88 x 430mm (17.32 x 3.46 x 16.92 inch)	H (leg not included)
Weight		SRD-830 : ~6.57Kg(14.48lb) SRD-830D : ~7.42Kg(16.35lb) SRD-1610/1630 : ~6.70kg(14.77lb) SRD-1610D/1630D : ~7.55Kg(16.64lb)	



It needs extra H/W to support ATM/POS function. So please contact your vendor to obtain H/W.

PRODUCT SPECIFICATION (SRD-850/850D/870/870D/1650/1650D/1670/1670D)

Item		Details	Note									
Operating System		Embedded OS										
Broadcast Format		NTSC/PAL System										
Input Voltage		AC 100~230V (PAL) AC 110~220V (NTSC)										
Power Consumption		SRD-1670/1670D : 60W SRD-870/870D : 56W SRD-850/850D/1650/1650D : 55W										
Video	Video In	Composite 16(8) Channel - 1.0Vp-p - 75Ω Hi Z Termination BNC Type Loop Through Out 16(8) Channel - Auto Termination										
	Video Out	Composite 5 Channel(SRD-1670/1670D) 3 Channel(SRD-870/870D) 2 Channel(SRD-850/850D/1650/1650D) - Normal Video Output 1 Channel - Spot Output 4 (SRD-1670/1670D), 2 (SRD-870/870D) 1 (SRD-850/850D/1650/1650D) - BNC Type VGA 1 Channel HDMI 1 Channel										
Audio	Audio In	Mono 16(8) Channel - 5dBm, 600Ω 4 Channel : RCA Type 12 Channel : d-sub Accessory (Optional)										
	Audio Out	Mono 1 Channel - 6dBm RCA Type										
Live Screen	Resolution & Frame Rate	<table border="1"> <thead> <tr> <th></th> <th>NTSC</th> <th>PAL</th> </tr> </thead> <tbody> <tr> <td>Resolution</td> <td>704x480</td> <td>704x576</td> </tr> <tr> <td>Frame Rate</td> <td>480ips(16Ch)/ 240ips(8Ch)</td> <td>400ips(16Ch)/ 200ips(8Ch)</td> </tr> </tbody> </table>		NTSC	PAL	Resolution	704x480	704x576	Frame Rate	480ips(16Ch)/ 240ips(8Ch)	400ips(16Ch)/ 200ips(8Ch)	
			NTSC	PAL								
	Resolution	704x480	704x576									
Frame Rate	480ips(16Ch)/ 240ips(8Ch)	400ips(16Ch)/ 200ips(8Ch)										
Display Mode	Single Split Modes : 16CH : 4-, 6-, 8-, 9-, 13-, 16- splits 8CH : 4-, 6-, 8-, 9-, 13- splits PIP Mode sequence Freeze 2 X Zoom											

appendix

Item		Details			Note
Record	Compression Method	Video : H.264 Audio : G.723			
	Resolution & Quality	Resolution	Spec. (Quality)	Max Recording Rate	
		CIF(S) 352x240(NTSC) /352x288(PAL)	Level8 (high) ~ Level1 (low)	480(240)ips(NTSC)/ 400(200)ips(PAL)	SRD-1650/D (SRD-850/D)
		Half D1(M) 704x240(NTSC) /704x288(PAL)	Level8 (high) ~ Level1 (low)	240(120)ips(NTSC)/ 200(100)ips(PAL)	SRD-1650/D (SRD-850/D)
		Full D1(L) 704x480(NTSC) /704x576(PAL)	Level8 (high) ~ Level1 (low)	120(60)ips(NTSC)/ 100(50)ips(PAL)	SRD-1650/D (SRD-850/D)
	CIF(S) /Half D1(M) /Full D1(L)	Level8 (high) ~ Level1 (low)	480(240)ips(NTSC)/ 400(200)ips(PAL)	SRD-1670/D (SRD-870/D)	
Record Mode	Normal Recording → REC button Scheduled Recording → Schedule Table Event Recording - Alarm Detection - Motion Detection - Video Loss - Pre & Post Recording				
Frame Rate	NTSC : 0.9, 1.9, 3.8, 7.5, 15, 30ips PAL : 0.8, 1.6, 3.1, 6.2, 12.5, 25ips				
Storage	Internal	SRD-850D/870D/1650D/1670D : SATA HDDx5(MAX) MAX HDD size : 1TB x 5 = 5TB SRD-850/870/1650/1670 : SATA HDDx6(MAX) MAX HDD size : 1TB x 6 = 6TB			If you want to add an internal HDD, please refer to "Adding a HDD". (Page 16)
	External	USB HDD - MAX 1 (USB hub not supported) - MAX HDD Size : 500GB SATA HDD - 2 Port - MAX 1HDD/port - MAX HDD Size : 500GB			
Play	Search Mode	Calendar Search Event Search - Alarm, Motion, Video Loss Time/Date Search Go to First Go to Last Backup Search Text Search(for POS) Motion Search Preview			

Item		Details		Note
Play	Resolution & Specification	Resolution	Specification	
		CIF(S) 352X240(NTSC) /352X288(PAL)	480(240)ips(NTSC)/ 400(200)ips(PAL)	SRD-1650/D (SRD-850/D)
		Half D1(M) 704x240(NTSC) /704x288(PAL)	240(120)ips(NTSC)/ 200(100)ips(PAL)	SRD-1650/D (SRD-850/D)
		Full D1(L) 704x480(NTSC) /704x576(PAL)	120(60)ips(NTSC)/ 100(50)ips(PAL)	SRD-1650/D (SRD-850/D)
	Display Mode	Single /4-/9-/13-/16-splits		
	Play Mode	Play, Pause, Stop, 2xDigital Zoom Fast Forward/Fast Reverse - 2x, 4x, 8x, 16x, 32x, 64x		
Backup		USB External HDD USB CD/DVD Writer, Internal DVD (SRD-850D/870D/1650D/1670D only) USB Memory USB HDD-MAX 1(USB hub not supported) SATA HDD-MAX 1		
Network		Ethernet : 10/100/1000 BaseT, ADSL(PPPoE), DHCP		
Serial Communication		RS-485 → PTZ Device Control Remote Control Device RS-232C → POS		
Alarm		Input : SRD-1650/1650D/1670/1670D : 16 channels SRD-850/850D/870/870D : 8 channels		
Remote Viewer	PC Requirements	CPU : Intel Core 2 Quad 2.5GHz or higher RAM : 2G VGA : 32M RAM(64M or more) DirectX 8.1		
	Operating Systems	Windows XP(Pro), Windows-2000(Pro) Windows Vista(Home Basic/Premium) Windows 7		
	Features	Live Image Monitoring Mode Local File Search & Play Back Mode Remote File Search & Play Back Mode		
Temperature (Operation)		0°C ~ 40°C (32°F ~ 104°F)		
Temperature (Storage)		-20°C ~ 60°C (-4°F ~ 140°F)		
Humidity (Operation)		20% to 85% RH		
Humidity (Storage)		20% to 85% RH		
Dimension (W x H x D)		440 x 88 x 430mm (17.32 x 3.46 x 16.92 inch)		H (leg not included)
Weight		SRD-850/870 : ~6.57Kg(14.48lb) SRD-850D/870D : ~7.42Kg(16.35lb) SRD-1650/1670 : ~6.70kg(14.77lb) SRD-1650D/1670D : ~7.55Kg(16.64lb)		



It needs extra H/W to support ATM/POS function. So please contact your vendor to obtain H/W.

appendix

PRODUCT OVERVIEW

- SRD-1670D

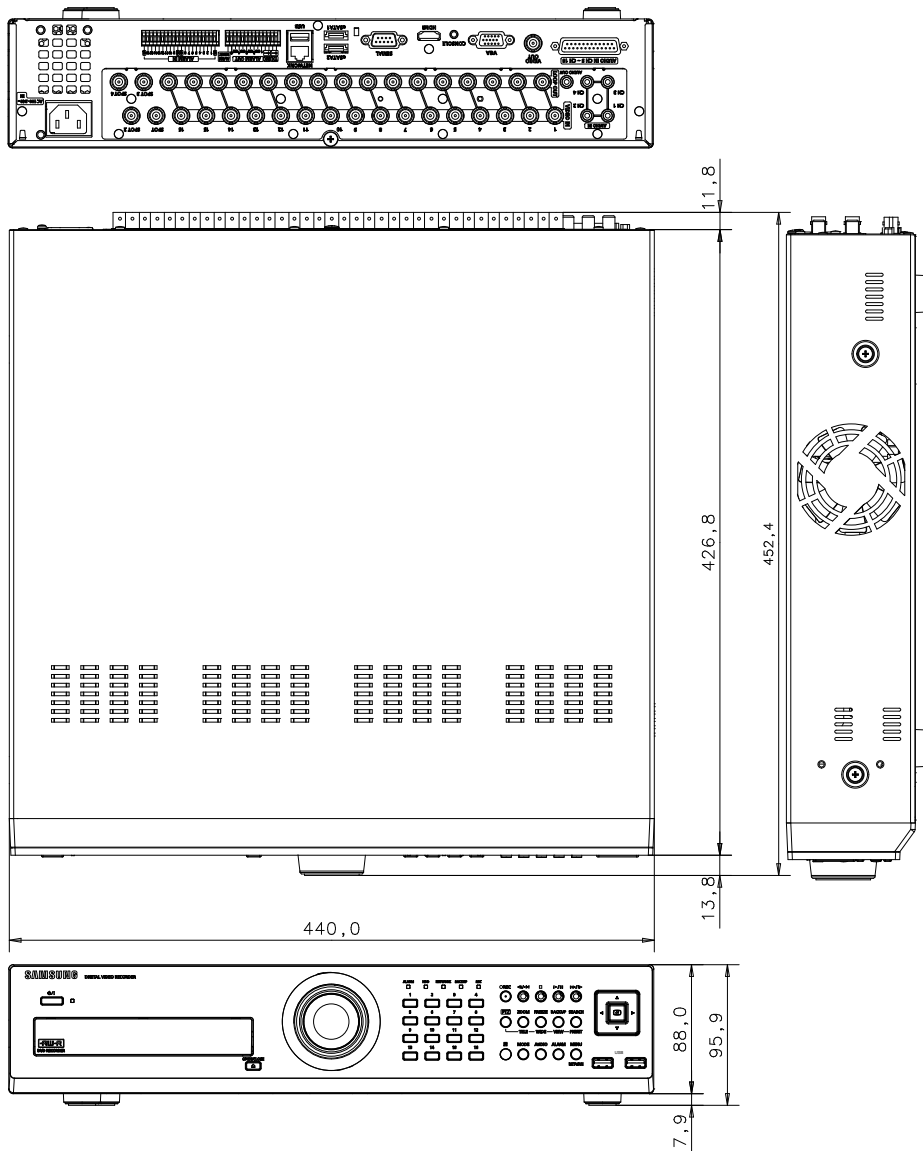

DEFAULT SETTING

This returns the factory default settings.

The settings are made as follows;

- Use System/Load Factory Default in MENU
- The default settings are based on SRD-1670D.

Category	Details			Factory Default
System Settings	Date/Time/Language	Date/Time/Language	Date	YYYY-MM-DD
			Time Format	24 hours
			Time Zone	GMT
			Time Synchronize	OFF
			DST	OFF
			Language	English
	Permission Management	Admin	ID	admin
			New Password	4321
		Setting	Restricted Access	All
			Auto Logout	3 Min
System Management	System Information	Broadcast Format	NTSC/PAL	
Device	Camera	Camera	Video	ON
			Audio	OFF
			CH Name	CAM 01 ~ CAM 16
			SEQ-Dwell Time	5sec
		PTZ	ID	Camera No.
			Protocol	None
		Screen Setup	Brightness	50
			Contrast	50
	Color		50	
	Storage Device	HDD Alarm	Check Alarm Output Port	OFF
			Duration	OFF
			Replace Alarm Output Port	OFF
			Duration	OFF
	Remote Device		Baudrate	9600
			Parity	None
			Data	8
			Stop bit	1
Transfer Type			Half Duplex	
System Keyboard			OFF	
Remote Control			ON(00)	

appendix

Category	Details			Factory Default
Device	POS Device			OFF
	Monitor	Monitor	Display	All
			Switch to Split Screen	5 sec
			VGA	800x600
			HDMI	480p
		Spot Out	Spot Out 1	CH1 ~ CH4
			Spot Out 2	CH5 ~ CH8
			Spot Out 3	CH9 ~ CH12
			Spot Out 4	CH13 ~ CH16
			Event Display	OFF
Mode		Live Mode	ALL	
	Play Mode	ALL		
Recording	Recording Schedule	Channel 1		Event
	Event Record Duration	PRE Event		OFF
		POST Event		1 min
	REC Quality/Resolution	Normal Recording	Resolution	CIF(S)
			Frame Rate	7.5 ips
			Record Quality	Level 4
		Event	Resolution	Full D1(L)
			Frame Rate	30 ips
			Record Quality	Level 4
	Record Option	Disk End Mode	Setup	Overwrite
			Disk End Beep	OFF
		Auto Delete		OFF
	Event	Sensor Detection	Sensor Operation	OFF
			Camera	Camera No.
			Alarm	None
			Duration	10 sec
		Motion Detection	Mode	OFF
			Sensitivity	Very High
Alarm			None	
Duration			10 sec	
Motion Region			All Area	
Video Loss Detection		Video Loss State	OFF	
	Alarm	None		
	Duration	10 sec		

Category	Details			Factory Default
Network	Connection Mode	Connection	Connection Mode	Static IP
			Bandwidth	2Mbps
			IP	192.168.1.200
			Gateway	192.168.1.1
			Subnet Mask	255.255.255.0
			DNS	168.126.63.1
	Protocol	Protocol	Protocol Type	TCP
			Port (TCP)	554~557
			Webviewer Port	80
	DDNS	DDNS Site		OFF
	Live Transfer	Resolution		CIF(S)
		Quality		Low
	Mailing Service	SMTP	Server	OFF
			Port	25
			Use Authentication	OFF
Secure Transfer			Never	
Group		Group	OFF	
		Recipient Permission	OFF	
Event		Event Interval	10 min	
	Use Event Transfer	OFF		

appendix

TROUBLESHOOTING

Symptom	Countermeasures
The system does not turn on and the indicator on the front panel does not work at all.	<ul style="list-style-type: none"> • Check if the power supply system is properly connected. • Check the system for the input voltage from the power source. • If the problem persists even after you have taken the above actions, check the power supplier and replace it with a new one if necessary.
Some channels display just a black screen even if they receive video sources.	<ul style="list-style-type: none"> • Check if the camera connected to the system properly displays the image. Sometimes, this problem may occur on a camera that is not properly connected to the video source. • Check if the camera is properly supplied with power. • Sometimes, this problem may occur on a channel with weak video signal from a video distributor that is connected to multiple systems. In this case, input the video source of the camera directly into the DVR. This may find the cause and solve the problem.
If I press the [REC] button on the front panel, the REC indicator does not flash, nor the player start recording.	<ul style="list-style-type: none"> • Check if there is a free space on the HDD for the recording. • Check if the record mode is set to ON in the record mode setting.
The screen displays the logo image repeatedly.	<ul style="list-style-type: none"> • This may occur from a problem with the main board, or the related software is corrupt. Contact the nearest service center for more information.
The Channel button does not work on the Live screen.	<ul style="list-style-type: none"> • The Channel button does not work if the current screen is in the event monitoring mode. In the event monitoring screen, press the [ALARM] button to exit the screen and select a channel.
The cursor will not move to the Start button when I start the calendar search.	<ul style="list-style-type: none"> • Check if the channel and the date that you want to play are marked with the V symbol. Both channel and date should be checked before you can start playing with the Start button.
When the alarm sounds, I press the [ALARM] button on the front panel to release the alarm but it does not work. The alarm persists and I could not set it off in any way.	<ul style="list-style-type: none"> • Press the [MENU] button on the front panel to release the alarm in the following way: <ol style="list-style-type: none"> 1) To release the event monitoring mode : Monitoring Mode – set the duration of the event monitoring to Off. 2) To release the alarm sound : Event Record Mode - Alarm (Motion Detection/Video Loss) – deactivate the alarm sound. 3) To release the event : Event Record Mode - Alarm (Motion Detection/Video Loss) – set the mode to Off.
No response is made even if I press the [PTZ] button on the Live screen.	<ul style="list-style-type: none"> • Menu → Camera → Check if the current protocols and other settings in the PTZ device are properly configured according to the PTZ camera.

Symptom	Countermeasures
I've found that the DVR does not recognize as many disks as installed when I have connected multiple external HDDs to the DVR.	<ul style="list-style-type: none"> • It takes time for the DVR to recognize multiple external HDDs. Try again in a moment and if the problem (of failure to recognize as many HDDs as connected) persists, it may occur due to a mechanical error of the HDD installed. Try again with a different HDD.
A message of "Need to reset date/time." is displayed on the screen.	<ul style="list-style-type: none"> • This message is displayed if there occurs a problem with the time setting of the internal clock or an error in the clock itself. Contact the retailer or the service center for more information.
The time bar is not displayed in Search mode.	<ul style="list-style-type: none"> • The timeline can switch between normal and extension mode. In extension mode, the time bar may not be displayed in the current timeline. Switch to normal mode or use the left or right button to navigate through the time bar.
The "NO HDD" icon and an error message are displayed.	<ul style="list-style-type: none"> • Check the HDD for connection. If the problem persists in a normal condition, contact the nearest service center to have the HDD checked by the service personnel.
I have installed an additional HDD on the DVR but it does not recognize the HDD.	<ul style="list-style-type: none"> • See the compatibility list to check if the additional HDD is supported by the DVR. For the compatibility list, contact the retailer where you purchased the DVR.
I have connected an external storage device (external SATA HDD) to the DVR but the DVR seems not to recognize it.	<ul style="list-style-type: none"> • See the compatibility list of external storage devices to check if the connected device is supported by the DVR. For the compatibility list, contact the retailer where you purchased the DVR.
If I press the ESC key in full screen mode of the WebViewer, the system does not switch to a normal split mode.	<ul style="list-style-type: none"> • Press the ALT+TAB keys to select 'ACTIVE MOVIE' and press the ESC key again. The system will switch to a normal split mode.
I found it difficult to configure the network settings if using the default search, backup and router settings.	<ul style="list-style-type: none"> • For more information, refer to the user manual. • If you want to check the basics of the product for a quick start, refer to the quick start guide (backup, search). • If you use the router for network connection, refer to the "Connecting to the Internet using the router" section in this manual.
I forgot the password.	<ul style="list-style-type: none"> • Contact the DVR administrator for help.
Backup data is just not played by the PC or DVR.	<ul style="list-style-type: none"> • When you are backing up data, you have choices about the player either: PC or DVR. Make your selection before proceeding. • If you are using the PC to play the data, the format of the backup file should be either AVI or SEC. • If you are using the DVR for this purpose, formatting backup files should be done by the DVR.
My player does not switch to Live mode while in playback.	<ul style="list-style-type: none"> • Press the Stop [■] button on the DVR or the remote control, or click the [■] icon on the launcher to switch to Live mode.

appendix

Symptom	Countermeasures
Recording does not work.	<ul style="list-style-type: none"> • If your player does not display a Live image at all, that indicates recording does not work so first check if you see an image on the screen. • Recording does not work if the recording settings are not properly configured. <ol style="list-style-type: none"> 1) Manual Record: Press the [REC] button on the front panel of the DVR or on the remote control to start recording. 2) Scheduled Record: Specify a desired time in Menu – Record - Recording Schedule. Recording will start at the specified time. <ul style="list-style-type: none"> - <Continuous> Record: Recording will proceed in any conditions at the specified time. - <Event> Record: When an event occurs, recording will perform only if the event is of alarm, motion detection and video loss. If there is no event found, recording will not perform. - <Continuous / Event> Record: If there is no event found, Continuous recording will perform. Whereas, if an event occurs, Event recording will perform.
The image quality of the recording data is not good.	<ul style="list-style-type: none"> • Increase the resolution and quality level in Menu – Record – Quality / Resolution. <ol style="list-style-type: none"> 1) Resolution: Select a bigger size when specifying the recording size. (FullD1>HalfD1>CIF) The recording image in the CIF format shows a deteriorated quality as it is enlarged from a small-sized image. 2) Record Quality: Specify a bigger level for the recording quality. • If you increase the resolution and the recording quality, the data size increases accordingly. So the HDD will be filled faster. Overwriting will overwrite the existing data so recording will proceed at a shorter interval.

OPEN SOURCE LICENSE REPORT ON THE PRODUCT

The software included in this product contains copyrighted software that is licensed under the GPL/LGPL. You may obtain the complete Corresponding Source code from us for a period of three years after our last shipment of this product by sending email to help.cctv@samsung.com

If you want to obtain the complete Corresponding Source code in the physical medium such as CD-ROM, the cost of physically performing source distribution might be charged.

- GPL S/W
 - Base Kernel, Busybox, Sysvinit, dosfstools
- LGPL S/W
 - glibc, inetutils

GNU GENERAL PUBLIC LICENSE

Version 2, June 1991

Copyright (C) 1989, 1991 Free Software Foundation, Inc.
51 Franklin Street, Fifth Floor, Boston, MA 02110-1301, USA

Everyone is permitted to copy and distribute verbatim copies of this license document, but changing it is not allowed.

Preamble

The licenses for most software are designed to take away your freedom to share and change it. By contrast, the GNU General Public License is intended to guarantee your freedom to share and change free software to make sure the software is free for all its users. This General Public License applies to most of the Free Software Foundation's software and to any other program whose authors commit to using it. (Some other Free Software Foundation software is covered by the GNU Lesser General Public License instead.) You can apply it to your programs, too.

When we speak of free software, we are referring to freedom, not price. Our General Public Licenses are designed to make sure that you have the freedom to distribute copies of free software (and charge for this service if you wish), that you receive source code or can get it if you want it, that you can change the software or use pieces of it in new free programs; and that you know you can do these things.

To protect your rights, we need to make restrictions that forbid anyone to deny you these rights or to ask you to surrender the rights. These restrictions translate to certain responsibilities for you if you distribute copies of the software, or if you modify it.

For example, if you distribute copies of such a program, whether gratis or for a fee, you must give the recipients all the rights that you have. You must make sure that they, too, receive or can get the source code. And you must show them these terms so they know their rights.

We protect your rights with two steps:

(1) copyright the software, and (2) offer you this license which gives you legal permission to copy, distribute and/or modify the software.

Also, for each author's protection and ours, we want to make certain that everyone understands that there is no warranty for this free software. If the software is

modified by someone else and passed on, we want its recipients to know that what they have is not the original, so that any problems introduced by others will not reflect on the original authors' reputations.

Finally, any free program is threatened constantly by software patents. We wish to avoid the danger that redistributors of a free program will individually obtain patent licenses, in effect making the program proprietary. To prevent this, we have made it clear that any patent must be licensed for everyone's free use or not licensed at all. The precise terms and conditions for copying, distribution and modification follow.

TERMS AND CONDITIONS FOR COPYING, DISTRIBUTION AND MODIFICATION

Version 2, June 1991

Copyright (C) 1989, 1991 Free Software Foundation, Inc.
51 Franklin S

0. This License applies to any program or other work which contains a notice placed by the copyright holder saying it may be distributed under the terms of this General Public License. The "Program", below, refers to any such program or work, and a "work based on the Program" means either the Program or any derivative work under copyright law: that is to say, a work containing the Program or a portion of it, either verbatim or with modifications and/or translated into another language. (Hereinafter, translation is included without limitation in the term "modification".) Each licensee is addressed as "you".

Activities other than copying, distribution and modification are not covered by this License; they are outside its scope. The act of running the Program is not restricted, and the output from the Program is covered only if its contents constitute a work based on the Program (independent of having been made by running the Program). Whether that is true depends on what the Program does.

1. You may copy and distribute verbatim copies of the Program's source code as you receive it, in any medium, provided that you conspicuously and appropriately publish on each copy an appropriate copyright notice and disclaimer of warranty; keep intact all the notices that refer to this License and to the absence of any warranty; and give any other recipients

of the Program a copy of this License along with the Program.

You may charge a fee for the physical act of transferring a copy, and you may at your option offer warranty protection in exchange for a fee.

2. You may modify your copy or copies of the Program or any portion of it, thus forming a work based on the Program, and copy and distribute such modifications or work under the terms of Section 1 above, provided that you also meet all of these conditions:

- a) You must cause the modified files to carry prominent notices stating that you changed the files and the date of any change.
- b) You must cause any work that you distribute or publish, that in whole or in part contains or is derived from the Program or any part thereof, to be licensed as a whole at no charge to all third parties under the terms of this License.
- c) If the modified program normally reads commands interactively when run, you must cause it, when started running for such interactive use in the most ordinary way, to print or display an announcement including an appropriate copyright notice and a notice that there is no warranty (or else, saying that you provide a warranty) and that users may redistribute the program under these conditions, and telling the user how to view a copy of this License. (Exception: if the Program itself is interactive but does not normally print such an announcement, your work based on the Program is not required to print an announcement.)

These requirements apply to the modified work as a whole. If identifiable sections of that work are not derived from the Program, and can be reasonably considered independent and separate works in themselves, then this License, and its terms, do not apply to those sections when you distribute them as separate works. But when you distribute the same sections as part of a whole which is a work based on the Program, the distribution of the whole must be on the terms of this License, whose permissions for other licensees extend to the entire whole, and thus to each and every part regardless of who wrote it.

Thus, it is not the intent of this section to claim rights or contest your rights to work written entirely by you; rather, the intent is to exercise the right to control the distribution of derivative or collective works based on the Program.

In addition, mere aggregation of another work not based on the Program with the Program (or with a work based on the Program) on a volume of a storage or distribution medium does not bring the other work under the scope of this License.

3. You may copy and distribute the Program (or a work based on it, under Section 2) in object code or executable form under the terms of Sections 1 and 2 above provided that you also do one of the following:

- a) Accompany it with the complete corresponding machine-readable source code, which must be distributed under the terms of Sections 1 and 2 above on a medium customarily used for software interchange; or,

- b) Accompany it with a written offer, valid for at least three years, to give any third party, for a charge no more than your cost of physically performing source distribution, a complete machine-readable copy of the corresponding source code, to be distributed under the terms of Sections 1 and 2 above on a medium customarily used for software interchange; or,

- c) Accompany it with the information you received as to the offer to distribute corresponding source code. (This alternative is allowed only for noncommercial distribution and only if you received the program in object code or executable form with such an offer, in accord with Subsection b above.)

The source code for a work means the preferred form of the work for making modifications to it. For an executable work, complete source code means all the source code for all modules it contains, plus any associated interface definition files, plus the scripts used to control compilation and installation of the executable. However, as a special exception, the source code distributed need not include anything that is normally distributed (in either source or binary form) with the major components (compiler, kernel, and so on) of the operating system on which the executable runs, unless that component itself accompanies the executable.

If distribution of executable or object code is made by offering access to copy from a designated place, then offering equivalent access to copy the source code from the same place counts as distribution of the source code, even though third parties are not compelled to copy the source along with the object code.

4. You may not copy, modify, sublicense, or distribute the Program except as expressly provided under this License. Any attempt otherwise to copy, modify, sublicense or distribute the Program is void, and will automatically terminate your rights under this License. However, parties who have received copies, or rights, from you under this License will not have their licenses terminated so long as such parties remain in full compliance.

5. You are not required to accept this License, since you have not signed it. However, nothing else grants you permission to modify or distribute the Program or its derivative works. These actions are prohibited by law if you do not accept this License. Therefore, by modifying or distributing the Program (or any work based on the Program), you indicate your acceptance of this License to do so, and all its terms and conditions for copying, distributing or modifying the Program or works based on it.

6. Each time you redistribute the Program (or any work based on the Program), the recipient automatically receives a license from the original licensor to copy, distribute or modify the Program subject to these terms and conditions. You may not impose any further restrictions on the recipients' exercise of the rights granted herein. You are not responsible for enforcing compliance by third parties to this License.

7. If, as a consequence of a court judgment or allegation of patent infringement or for any other reason (not limited to patent issues), conditions are imposed on you (whether by court order, agreement or otherwise) that contradict the conditions of this License, they do not excuse you from the conditions of this License. If you cannot distribute so as to satisfy simultaneously your obligations under this License and any other pertinent obligations, then as a consequence you may not distribute the Program at all. For example, if a patent license would not permit royalty-free redistribution of the Program by all those who receive copies directly or indirectly through you, then the only way you could satisfy both it and this License would be to refrain entirely from distribution of the Program.

If any portion of this section is held invalid or unenforceable under any particular circumstance, the balance of the section is intended to apply and the section as a whole is intended to apply in other circumstances.

It is not the purpose of this section to induce you to infringe any patents or other property right claims or to contest validity of any such claims; this section has the sole purpose of protecting the integrity of the free software distribution system, which is implemented by public license practices. Many people have made generous contributions to the wide range of software distributed through that system in reliance on consistent application of that system; it is up to the author/donor to decide if he or she is willing to distribute software through any other system and a licensee cannot impose that choice.

This section is intended to make thoroughly clear what is believed to be a consequence of the rest of this License.

8. If the distribution and/or use of the Program is restricted in certain countries either by patents or by copyrighted interfaces, the original copyright holder who places the Program under this License may add an explicit geographical distribution limitation excluding those countries, so that distribution is permitted only in or among countries not thus excluded. In such case, this License incorporates the limitation as if written in the body of this License.

9. The Free Software Foundation may publish revised and/or new versions of the General Public License from time to time. Such new versions will be similar in spirit to the present version, but may differ in detail to address new problems or concerns.

Each version is given a distinguishing version number. If the Program specifies a version number of this License which applies to it and "any later version", you have the option of following the terms and conditions either of that version or of any later version published by the Free Software Foundation. If the Program does not specify a version number of this License, you may choose any version ever published by the Free Software Foundation.

10. If you wish to incorporate parts of the Program into other free programs whose distribution conditions are different, write to the author to ask for permission. For software which is copyrighted by the Free Software Foundation, write to the Free Software Foundation; we sometimes make exceptions for this. Our decision will be guided by the two goals of preserving the free status of all derivatives of our free software and of promoting the sharing and reuse of software generally.

NO WARRANTY

11. BECAUSE THE PROGRAM IS LICENSED FREE OF CHARGE, THERE IS NO WARRANTY FOR THE PROGRAM, TO THE EXTENT PERMITTED BY APPLICABLE LAW. EXCEPT WHEN OTHERWISE STATED IN WRITING THE COPYRIGHT HOLDERS AND/OR OTHER PARTIES PROVIDE THE PROGRAM "AS IS" WITHOUT WARRANTY OF ANY KIND, EITHER EXPRESSED OR IMPLIED, INCLUDING, BUT NOT LIMITED TO, THE IMPLIED WARRANTIES OF MERCHANTABILITY AND FITNESS FOR A PARTICULAR PURPOSE. THE ENTIRE RISK AS TO THE QUALITY AND PERFORMANCE OF THE PROGRAM IS WITH YOU. SHOULD THE PROGRAM PROVE DEFECTIVE, YOU ASSUME THE COST OF ALL NECESSARY SERVICING, REPAIR OR CORRECTION.

12. IN NO EVENT UNLESS REQUIRED BY APPLICABLE LAW OR AGREED TO IN WRITING WILL ANY COPYRIGHT HOLDER, OR ANY OTHER PARTY WHO MAY MODIFY AND/OR REDISTRIBUTE THE PROGRAM AS PERMITTED ABOVE, BE LIABLE TO YOU FOR DAMAGES, INCLUDING ANY GENERAL, SPECIAL, INCIDENTAL OR CONSEQUENTIAL DAMAGES ARISING OUT OF THE USE OR INABILITY TO USE THE PROGRAM (INCLUDING BUT NOT LIMITED TO LOSS OF DATA OR DATA BEING RENDERED INACCURATE OR LOSSES SUSTAINED BY YOU OR THIRD PARTIES OR A FAILURE OF THE PROGRAM TO OPERATE WITH ANY OTHER PROGRAMS), EVEN IF SUCH HOLDER OR OTHER PARTY HAS BEEN ADVISED OF THE POSSIBILITY OF SUCH DAMAGES.

END OF TERMS AND CONDITIONS

How to Apply These Terms to Your New Programs

If you develop a new program, and you want it to be of the greatest possible use to the public, the best way to achieve this is to make it free software which everyone can redistribute and change under these terms.

To do so, attach the following notices to the program. It is safest to attach them to the start of each source file to most effectively convey the exclusion of warranty; and each file should have at least the "copyright" line and a pointer to where the full notice is found.

one line to give the program's name and an idea of what it does.

Copyright (C) yyyy name of author

This program is free software; you can redistribute it and/or modify it under the terms of the GNU General Public License as published by the Free Software Foundation; either version 2 of the License, or (at your option) any later version.

This program is distributed in the hope that it will be useful, but WITHOUT ANY WARRANTY; without even the implied warranty of MERCHANTABILITY or FITNESS FOR A PARTICULAR PURPOSE. See the GNU General Public License for more details.

You should have received a copy of the GNU General Public License along with this program; if not, write to the Free Software Foundation, Inc., 51 Franklin Street, Fifth Floor, Boston, MA 02110-1301, USA.

Also add information on how to contact you by electronic and paper mail. If the program is interactive, make it output a short notice like this when it starts in an interactive mode:

Gnomovision version 69, Copyright (C) year name of author
Gnomovision comes with ABSOLUTELY NO WARRANTY; for details type 'show w'. This is free software, and you are welcome to redistribute it under certain conditions; type 'show c' for details.

The hypothetical commands 'show w' and 'show c' should show the appropriate parts of the General Public License. Of course, the commands you use may be called something other than 'show w' and 'show c'; they could even be mouse-clicks or menu items-- whatever suits your program.

You should also get your employer (if you work as a programmer) or your school, if any, to sign a "copyright disclaimer" for the program, if necessary. Here is a sample; alter the names:

Yoyodyne, Inc., hereby disclaims all copyright interest in the program 'Gnomovision' (which makes passes at compilers) written by James Hacker.

signature of Ty Coon, 1 April 1989 Ty Coon, President of Vice
This General Public License does not permit incorporating your program into proprietary programs. If your program is a subroutine library, you may consider it more useful to permit linking proprietary applications

with the library. If this is what you want to do, use the GNU Lesser General Public License instead of this License.

GNU GENERAL PUBLIC LICENSE

Version 3, 29 June 2007

Copyright © 2007 Free Software Foundation, Inc.
<<http://fsf.org/>>

Everyone is permitted to copy and distribute verbatim copies of this license document, but changing it is not allowed.

Preamble

The GNU General Public License is a free, copyleft license for software and other kinds of works.

The licenses for most software and other practical works are designed to take away your freedom to share and change the works. By contrast, the GNU General Public License is intended to guarantee your freedom to share and change all versions of a program--to make sure it remains free software for all its users. We, the Free Software Foundation, use the GNU General Public License for most of our software; it applies also to any other work released this way by its authors. You can apply it to your programs, too.

When we speak of free software, we are referring to freedom, not price. Our General Public Licenses are designed to make sure that you have the freedom to distribute copies of free software (and charge for them if you wish), that you receive source code or can get it if you want it, that you can change the software or use pieces of it in new free programs, and that you know you can do these things.

To protect your rights, we need to prevent others from denying you these rights or asking you to surrender the rights. Therefore, you have certain responsibilities if you distribute copies of the software, or if you modify it: responsibilities to respect the freedom of others.

For example, if you distribute copies of such a program, whether gratis or for a fee, you must pass on to the recipients the same freedoms that you received. You must make sure that they, too, receive or can get the source code. And you must show them these terms so they know their rights.

Developers that use the GNU GPL protect your rights with two steps: (1) assert copyright on the software, and (2) offer you this License giving you legal permission to copy, distribute and/or modify it.

For the developers' and authors' protection, the GPL clearly explains that there is no warranty for this free software. For both users' and authors' sake, the GPL requires that modified versions be marked as changed, so that their problems will not be attributed erroneously to authors of previous versions.

Some devices are designed to deny users access to install or run modified versions of the software inside them, although the manufacturer can do so. This is fundamentally incompatible with the aim of protecting users' freedom to change the software. The systematic pattern of such abuse occurs in the area of products for individuals to use, which is precisely where it is most unacceptable. Therefore, we have designed this version of the GPL to prohibit the practice for those products. If such problems arise substantially in other domains, we stand ready to extend this provision to those domains in future versions of the GPL, as needed to protect the freedom of users.

Finally, every program is threatened constantly by software patents. States should not allow patents to restrict development and use of software on general-purpose computers, but in those that do, we wish to avoid the special danger that patents applied to a free program could make it effectively proprietary. To prevent this, the GPL assures that patents cannot be used to render the program non-free.

The precise terms and conditions for copying, distribution and modification follow.

TERMS AND CONDITIONS

0. Definitions.

"This License" refers to version 3 of the GNU General Public License.

"Copyright" also means copyright-like laws that apply to other kinds of works, such as semiconductor masks.

"The Program" refers to any copyrightable work licensed under this License. Each licensee is addressed as "you". "Licensees" and "recipients" may be individuals or organizations.

To "modify" a work means to copy from or adapt all or part of the work in a fashion requiring copyright permission, other than the making of an exact copy. The resulting work is called a "modified version" of the earlier work or a work "based on" the earlier work.

A "covered work" means either the unmodified Program or a work based on the Program.

To "propagate" a work means to do anything with it that, without permission, would make you directly or secondarily liable for infringement under applicable copyright law, except executing it on a computer or modifying a private copy. Propagation includes copying, distribution (with or without modification), making available to the public, and in some countries other activities as well.

To "convey" a work means any kind of propagation that enables other parties to make or receive copies. Mere interaction with a user through a computer network, with no transfer of a copy, is not conveying.

An interactive user interface displays "Appropriate Legal Notices" to the extent that it includes a convenient and prominently visible feature that (1) displays an appropriate copyright notice, and (2) tells the user that there is no warranty for the work (except to the extent that warranties are provided), that licensees may convey the work under this License, and how to view a copy of this License. If the interface presents a list of user commands or options, such as a menu, a prominent item in the list meets this criterion.

1. Source Code.

The "source code" for a work means the preferred form of the work for making modifications to it. "Object code" means any non-source form of a work.

A "Standard Interface" means an interface that either is an official standard defined by a recognized standards body, or, in the case of interfaces specified for a particular programming language, one that is widely used among developers working in that language.

The "System Libraries" of an executable work include anything, other than the work as a whole, that (a) is included in the normal form of packaging a Major Component, but which is not part of that Major Component, and (b) serves only to enable use of the work with that Major Component, or to implement a Standard Interface for which an implementation is available to the public in source code form. A "Major Component", in this context, means a major essential component (kernel, window system, and so on) of the specific operating system (if any) on which the executable work runs, or a compiler used to produce the work, or an object code interpreter used to run it.

The "Corresponding Source" for a work in object code form means all the source code needed to generate, install, and (for an executable work) run the object code and to modify the work, including scripts to control those activities. However, it does not include the work's System Libraries, or general-purpose tools or generally available free programs which are used unmodified in performing those activities but which are not part of the work. For example, Corresponding Source includes interface definition files associated with source files for the work, and the source code for shared libraries and dynamically linked subprograms that the work is specifically designed to require, such as by intimate data communication or control flow between those subprograms and other parts of the work.

The Corresponding Source need not include anything that users can regenerate automatically from other parts of the Corresponding Source.

The Corresponding Source for a work in source code form is that same work.

2. Basic Permissions.

All rights granted under this License are granted for the term of copyright on the Program, and are irrevocable provided the stated conditions are met. This License explicitly affirms your unlimited permission to run the unmodified Program. The output from running a covered work is covered by this License only if the output, given its content, constitutes a covered work. This License acknowledges your rights of fair use or other equivalent, as provided by copyright law.

You may make, run and propagate covered works that you do not convey, without conditions so long as your license otherwise remains in force. You may convey covered works to others for the sole purpose of having them make modifications exclusively for you, or provide you with facilities for running those works, provided that you comply with the terms of this License in conveying all material for which you do not control copyright. Those thus making or running the covered works for you must do so exclusively on your behalf, under your direction and control, on terms that prohibit them from making any copies of your copyrighted material outside their relationship with you.

Conveying under any other circumstances is permitted solely under the conditions stated below. Sublicensing is not allowed; section 10 makes it unnecessary.

3. Protecting Users' Legal Rights From Anti-Circumvention Law.

No covered work shall be deemed part of an effective technological measure under any applicable law fulfilling obligations under article 11 of the WIPO copyright treaty adopted on 20 December 1996, or similar laws prohibiting or restricting circumvention of such measures.

When you convey a covered work, you waive any legal power to forbid circumvention of technological measures to the extent such circumvention is effected by exercising rights under this License with respect to the covered work, and you disclaim any intention to limit operation or modification of the work as a means of enforcing, against the work's users, your or third parties' legal rights to forbid circumvention of technological measures.

4. Conveying Verbatim Copies.

You may convey verbatim copies of the Program's source code as you receive it, in any medium, provided that you conspicuously and appropriately publish on each copy an appropriate copyright notice; keep intact all notices stating that this License and any non-permissive terms added in accord with section 7 apply to the code; keep intact all notices of the absence of any warranty; and give all recipients a copy of this License along with the Program.

You may charge any price or no price for each copy that you convey, and you may offer support or warranty protection for a fee.

5. Conveying Modified Source Versions.

You may convey a work based on the Program, or the modifications to produce it from the Program, in the form of source code under the terms of section 4, provided that you also meet all of these conditions:

- a) The work must carry prominent notices stating that you modified it, and giving a relevant date.
- b) The work must carry prominent notices stating that it is released under this License and any conditions added under section 7. This requirement modifies the requirement in section 4 to "keep intact all notices".
- c) You must license the entire work, as a whole, under this License to anyone who comes into possession of a copy. This License will therefore apply, along with any applicable section 7 additional terms, to the whole of the work, and all its parts, regardless of how they are packaged. This License gives no permission to license the work in any other way, but it does not invalidate such permission if you have separately received it.
- d) If the work has interactive user interfaces, each must display Appropriate Legal Notices; however, if the Program has interactive interfaces that do not display Appropriate Legal Notices, your work need not make them do so.

A compilation of a covered work with other separate and independent works, which are not by their nature extensions of the covered work, and which are not combined with it such as to form a larger program, in or on a volume of a storage or distribution medium, is called an "aggregate" if the compilation and its resulting copyright are not used to limit the access or legal rights of the compilation's users beyond what the individual works permit. Inclusion of a covered work in an aggregate does not cause this License to apply to the other parts of the aggregate.

6. Conveying Non-Source Forms.

You may convey a covered work in object code form under the terms of sections 4 and 5, provided that you also convey the machine-readable Corresponding Source under the terms of this License, in one of these ways:

- a) Convey the object code in, or embodied in, a physical product (including a physical distribution medium), accompanied by the Corresponding Source fixed on a durable physical medium customarily used for software interchange.
- b) Convey the object code in, or embodied in, a physical product (including a physical distribution medium), accompanied by a written offer, valid for at least three years and valid for as long as you

offer spare parts or customer support for that product model, to give anyone who possesses the object code either (1) a copy of the Corresponding Source for all the software in the product that is covered by this License, on a durable physical medium customarily used for software interchange, for a price no more than your reasonable cost of physically performing this conveying of source, or (2) access to copy the Corresponding Source from a network server at no charge.

- c) Convey individual copies of the object code with a copy of the written offer to provide the Corresponding Source. This alternative is allowed only occasionally and noncommercially, and only if you received the object code with such an offer, in accord with subsection 6b.
- d) Convey the object code by offering access from a designated place (gratis or for a charge), and offer equivalent access to the Corresponding Source in the same way through the same place at no further charge. You need not require recipients to copy the Corresponding Source along with the object code. If the place to copy the object code is a network server, the Corresponding Source may be on a different server (operated by you or a third party) that supports equivalent copying facilities, provided you maintain clear directions next to the object code saying where to find the Corresponding Source. Regardless of what server hosts the Corresponding Source, you remain obligated to ensure that it is available for as long as needed to satisfy these requirements.
- e) Convey the object code using peer-to-peer transmission, provided you inform other peers where the object code and Corresponding Source of the work are being offered to the general public at no charge under subsection 6d.

A separable portion of the object code, whose source code is excluded from the Corresponding Source as a System Library, need not be included in conveying the object code work.

A “User Product” is either (1) a “consumer product”, which means any tangible personal property which is normally used for personal, family, or household purposes, or (2) anything designed or sold for incorporation into a dwelling. In determining whether a product is a consumer product, doubtful cases shall be resolved in favor of coverage. For a particular product received by a particular user, “normally used” refers to a typical or common use of that class of product, regardless of the status of the particular user or of the way in which the particular user actually uses, or expects or is expected to use, the product. A product is a consumer product regardless of whether the product has substantial commercial, industrial or non-consumer uses, unless such uses represent the only significant mode of use of the product.

“Installation Information” for a User Product means any methods, procedures, authorization keys, or other information required to install and execute modified versions of a covered work in that User Product from a modified version of its Corresponding Source. The information must suffice to ensure that the continued functioning of the modified object code is in no case prevented or interfered with solely because modification has been made.

If you convey an object code work under this section in, or with, or specifically for use in, a User Product, and the conveying occurs as part of a transaction in which the right of possession and use of the User Product is transferred to the recipient in perpetuity or for a fixed term (regardless of how the transaction is characterized), the Corresponding Source conveyed under this section must be accompanied by the Installation Information. But this requirement does not apply if neither you nor any third party retains the ability to install modified object code on the User Product (for example, the work has been installed in ROM).

The requirement to provide Installation Information does not include a requirement to continue to provide support service, warranty, or updates for a work that has been modified or installed by the recipient, or for the User Product in which it has been modified or installed. Access to a network may be denied when the modification itself materially and adversely affects the operation of the network or violates the rules and protocols for communication across the network.

Corresponding Source conveyed, and Installation Information provided, in accord with this section must be in a format that is publicly documented (and with an implementation available to the public in source code form), and must require no special password or key for unpacking, reading or copying.

7. Additional Terms.

“Additional permissions” are terms that supplement the terms of this License by making exceptions from one or more of its conditions. Additional permissions that are applicable to the entire Program shall be treated as though they were included in this License, to the extent that they are valid under applicable law. If additional permissions apply only to part of the Program, that part may be used separately under those permissions, but the entire Program remains governed by this License without regard to the additional permissions.

When you convey a copy of a covered work, you may at your option remove any additional permissions from that copy, or from any part of it. (Additional permissions may be written to require their own removal in certain cases when you modify the work.) You may place additional permissions on material, added by you to a covered work, for which you have or can give appropriate copyright permission.

Notwithstanding any other provision of this License, for material you add to a covered work, you may (if authorized by the copyright holders of that material) supplement the terms of this License with terms:

- a) Disclaiming warranty or limiting liability differently from the terms of sections 15 and 16 of this License; or
- b) Requiring preservation of specified reasonable legal notices or author attributions in that material or in the Appropriate Legal Notices displayed by works containing it; or
- c) Prohibiting misrepresentation of the origin of that material, or requiring that modified versions of such material be marked in reasonable ways as different from the original version; or
- d) Limiting the use for publicity purposes of names of licensors or authors of the material; or
- e) Declining to grant rights under trademark law for use of some trade names, trademarks, or service marks; or
- f) Requiring indemnification of licensors and authors of that material by anyone who conveys the material (or modified versions of it) with contractual assumptions of liability to the recipient, for any liability that these contractual assumptions directly impose on those licensors and authors.

All other non-permissive additional terms are considered “further restrictions” within the meaning of section 10. If the Program as you received it, or any part of it, contains a notice stating that it is governed by this License along with a term that is a further restriction, you may remove that term. If a license document contains a further restriction but permits relicensing or conveying under this License, you may add to a covered work material governed by the terms of that license document, provided that the further restriction does not survive such relicensing or conveying.

If you add terms to a covered work in accord with this section, you must place, in the relevant source files, a statement of the additional terms that apply to those files, or a notice indicating where to find the applicable terms.

Additional terms, permissive or non-permissive, may be stated in the form of a separately written license, or stated as exceptions; the above requirements apply either way.

8. Termination.

You may not propagate or modify a covered work except as expressly provided under this License. Any attempt otherwise to propagate or modify it is void, and will automatically terminate your rights under this License (including any patent licenses granted under the third paragraph of section 11).

However, if you cease all violation of this License, then your license from a particular copyright holder is reinstated (a) provisionally, unless and until the copyright holder explicitly and finally terminates your license, and (b) permanently, if the copyright holder fails to notify you of the violation by some reasonable means prior to 60 days after the cessation.

Moreover, your license from a particular copyright holder is reinstated permanently if the copyright holder notifies you of the violation by some reasonable means, this is the first time you have received notice of violation of this License (for any work) from that copyright holder, and you cure the violation prior to 30 days after your receipt of the notice.

Termination of your rights under this section does not terminate the licenses of parties who have received copies or rights from you under this License. If your rights have been terminated and not permanently reinstated, you do not qualify to receive new licenses for the same material under section 10.

9. Acceptance Not Required for Having Copies.

You are not required to accept this License in order to receive or run a copy of the Program. Ancillary propagation of a covered work occurring solely as a consequence of using peer-to-peer transmission to receive a copy likewise does not require acceptance. However, nothing other than this License grants you permission to propagate or modify any covered work. These actions infringe copyright if you do not accept this License. Therefore, by modifying or propagating a covered work, you indicate your acceptance of this License to do so.

10. Automatic Licensing of Downstream Recipients.

Each time you convey a covered work, the recipient automatically receives a license from the original licensors, to run, modify and propagate that work, subject to this License. You are not responsible for enforcing compliance by third parties with this License.

An “entity transaction” is a transaction transferring control of an organization, or substantially all assets of one, or subdividing an organization, or merging organizations. If propagation of a covered work results from an entity transaction, each party to that transaction who receives a copy of the work also receives whatever licenses to the work the party's predecessor in interest had or could give under the previous paragraph, plus a right to possession of the Corresponding Source of the work from the predecessor in interest, if the predecessor has it or can get it with reasonable efforts.

You may not impose any further restrictions on the exercise of the rights granted or affirmed under this License. For example, you may not impose a license fee, royalty, or other charge for exercise of rights granted under this License, and you may not initiate

litigation (including a cross-claim or counterclaim in a lawsuit) alleging that any patent claim is infringed by making, using, selling, offering for sale, or importing the Program or any portion of it.

11. Patents.

A “contributor” is a copyright holder who authorizes use under this License of the Program or a work on which the Program is based. The work thus licensed is called the contributor’s “contributor version”.

A contributor’s “essential patent claims” are all patent claims owned or controlled by the contributor, whether already acquired or hereafter acquired, that would be infringed by some manner, permitted by this License, of making, using, or selling its contributor version, but do not include claims that would be infringed only as a consequence of further modification of the contributor version. For purposes of this definition, “control” includes the right to grant patent sublicenses in a manner consistent with the requirements of this License.

Each contributor grants you a non-exclusive, worldwide, royalty-free patent license under the contributor’s essential patent claims, to make, use, sell, offer for sale, import and otherwise run, modify and propagate the contents of its contributor version.

In the following three paragraphs, a “patent license” is any express agreement or commitment, however denominated, not to enforce a patent (such as an express permission to practice a patent or covenant not to sue for patent infringement). To “grant” such a patent license to a party means to make such an agreement or commitment not to enforce a patent against the party.

If you convey a covered work, knowingly relying on a patent license, and the Corresponding Source of the work is not available for anyone to copy, free of charge and under the terms of this License, through a publicly available network server or other readily accessible means, then you must either (1) cause the Corresponding Source to be so available, or (2) arrange to deprive yourself of the benefit of the patent license for this particular work, or (3) arrange, in a manner consistent with the requirements of this License, to extend the patent license to downstream recipients. “Knowingly relying” means you have actual knowledge that, but for the patent license, your conveying the covered work in a country, or your recipient’s use of the covered work in a country, would infringe one or more identifiable patents in that country that you have reason to believe are valid.

If, pursuant to or in connection with a single transaction or arrangement, you convey, or propagate by procuring conveyance of, a covered work, and grant a patent license to some of the parties receiving the covered work authorizing them to use, propagate, modify or convey a specific copy of the covered work, then the patent license you grant is automatically extended to all recipients of the covered work and works based on it.

A patent license is “discriminatory” if it does not include within the scope of its coverage, prohibits the exercise of, or is conditioned on the non-exercise of one or more of the rights that are specifically granted under this License. You may not convey a covered work if you are a party to an arrangement with a third party that is in the business of distributing software, under which you make payment to the third party based on the extent of your activity of conveying the work, and under which the third party grants, to any of the parties who would receive the covered work from you, a discriminatory patent license (a) in connection with copies of the covered work conveyed by you (or copies made from those copies), or (b) primarily for and in connection with specific products or compilations that contain the covered work, unless you entered into that arrangement, or that patent license was granted, prior to 28 March 2007.

Nothing in this License shall be construed as excluding or limiting any implied license or other defenses to infringement that may otherwise be available to you under applicable patent law.

12. No Surrender of Others' Freedom.

If conditions are imposed on you (whether by court order, agreement or otherwise) that contradict the conditions of this License, they do not excuse you from the conditions of this License. If you cannot convey a covered work so as to satisfy simultaneously your obligations under this License and any other pertinent obligations, then as a consequence you may not convey it at all. For example, if you agree to terms that obligate you to collect a royalty for further conveying from those to whom you convey the Program, the only way you could satisfy both those terms and this License would be to refrain entirely from conveying the Program.

13. Use with the GNU Affero General Public License.

Notwithstanding any other provision of this License, you have permission to link or combine any covered work with a work licensed under version 3 of the GNU Affero General Public License into a single combined work, and to convey the resulting work. The terms of this License will continue to apply to the part which is the covered work, but the special requirements of the GNU Affero General Public License, section 13, concerning interaction through a network will apply to the combination as such.

14. Revised Versions of this License.

The Free Software Foundation may publish revised and/or new versions of the GNU General Public License from time to time. Such new versions will be similar in spirit to the present version, but may differ in detail to address new problems or concerns.

Each version is given a distinguishing version number. If the Program specifies that a certain numbered version of the GNU General Public License “or any later version” applies to it, you have the option of following the terms

and conditions either of that numbered version or of any later version published by the Free Software Foundation. If the Program does not specify a version number of the GNU General Public License, you may choose any version ever published by the Free Software Foundation.

If the Program specifies that a proxy can decide which future versions of the GNU General Public License can be used, that proxy's public statement of acceptance of a version permanently authorizes you to choose that version for the Program.

Later license versions may give you additional or different permissions. However, no additional obligations are imposed on any author or copyright holder as a result of your choosing to follow a later version.

15. Disclaimer of Warranty.

THERE IS NO WARRANTY FOR THE PROGRAM, TO THE EXTENT PERMITTED BY APPLICABLE LAW. EXCEPT WHEN OTHERWISE STATED IN WRITING THE COPYRIGHT HOLDERS AND/OR OTHER PARTIES PROVIDE THE PROGRAM "AS IS" WITHOUT WARRANTY OF ANY KIND, EITHER EXPRESSED OR IMPLIED, INCLUDING, BUT NOT LIMITED TO, THE IMPLIED WARRANTIES OF MERCHANTABILITY AND FITNESS FOR A PARTICULAR PURPOSE. THE ENTIRE RISK AS TO THE QUALITY AND PERFORMANCE OF THE PROGRAM IS WITH YOU. SHOULD THE PROGRAM PROVE DEFECTIVE, YOU ASSUME THE COST OF ALL NECESSARY SERVICING, REPAIR OR CORRECTION.

16. Limitation of Liability.

IN NO EVENT UNLESS REQUIRED BY APPLICABLE LAW OR AGREED TO IN WRITING WILL ANY COPYRIGHT HOLDER, OR ANY OTHER PARTY WHO MODIFIES AND/OR CONVEYS THE PROGRAM AS PERMITTED ABOVE, BE LIABLE TO YOU FOR DAMAGES, INCLUDING ANY GENERAL, SPECIAL, INCIDENTAL OR CONSEQUENTIAL DAMAGES ARISING OUT OF THE USE OR INABILITY TO USE THE PROGRAM (INCLUDING BUT NOT LIMITED TO LOSS OF DATA OR DATA BEING RENDERED INACCURATE OR LOSSES SUSTAINED BY YOU OR THIRD PARTIES OR A FAILURE OF THE PROGRAM TO OPERATE WITH ANY OTHER PROGRAMS), EVEN IF SUCH HOLDER OR OTHER PARTY HAS BEEN ADVISED OF THE POSSIBILITY OF SUCH DAMAGES.

17. Interpretation of Sections 15 and 16.

If the disclaimer of warranty and limitation of liability provided above cannot be given local legal effect according to their terms, reviewing courts shall apply local law that most closely approximates an absolute waiver of all civil liability in connection with the Program, unless a warranty or assumption of liability accompanies a copy of the Program in return for a fee.

END OF TERMS AND CONDITIONS

GNU LESSER GENERAL PUBLIC LICENSE

Version 2.1, February 1999

Copyright (C) 1991, 1999 Free Software Foundation, Inc.

51 Franklin Street, Fifth Floor, Boston, MA 02110-1301 USA

Everyone is permitted to copy and distribute verbatim copies of this license document, but changing it is not allowed.

[This is the first released version of the Lesser GPL. It also counts as the successor of the GNU Library Public License, version 2, hence the version number 2.1.]

Preamble

The licenses for most software are designed to take away your freedom to share and change it. By contrast, the GNU General Public Licenses are intended to guarantee your freedom to share and change free software to make sure the software is free for all its users.

This license, the Lesser General Public License, applies to some specially designated software packages--typically libraries--of the Free Software Foundation and other authors who decide to use it. You can use it too, but we suggest you first think carefully about whether this license or the ordinary General Public License is the better strategy to use in any particular case, based on the explanations below.

When we speak of free software, we are referring to freedom of use, not price. Our General Public Licenses are designed to make sure that you have the freedom to distribute copies of free software (and charge for this service if you wish); that you receive source code or can get it if you want it; that you can change the software and use pieces of it in new free programs; and that you are informed that you can do these things.

To protect your rights, we need to make restrictions that forbid distributors to deny you these rights or to ask you to surrender these rights. These restrictions translate to certain responsibilities for you if you distribute copies of the library or if you modify it.

For example, if you distribute copies of the library, whether gratis or for a fee, you must give the recipients all the rights that we gave you. You must make sure that they, too, receive or can get the source code. If you link other code with the library, you must provide complete object files to the recipients, so that they can relink them with the library after making changes to the library and recompiling it. And you must show them these terms so they know their rights.

We protect your rights with a two-step method: (1) we copyright the library, and (2) we offer you this license, which gives you legal permission to copy, distribute and/or modify the library.

To protect each distributor, we want to make it very clear that there is no warranty for the free library. Also, if the library is modified by someone else and passed on, the recipients should know that what they have is not the original version, so that the original author's reputation will not be affected by problems that might be introduced by others.

Finally, software patents pose a constant threat to the existence of any free program. We wish to make sure that a company cannot effectively restrict the users of a free program by obtaining a restrictive license from a patent holder. Therefore, we insist that any patent license obtained for a version of the library must be consistent with the full freedom of use specified in this license.

Most GNU software, including some libraries, is covered by the ordinary GNU General Public License. This license, the GNU Lesser General Public License, applies to certain designated libraries, and is quite different from the ordinary General Public License. We use this license for certain libraries in order to permit linking those libraries into non-free programs.

When a program is linked with a library, whether statically or using a shared library, the combination of the two is legally speaking a combined work, a derivative of the original library. The ordinary General Public License therefore permits such linking only if the entire combination fits its criteria of freedom. The Lesser General Public License permits more lax criteria for linking other code with the library.

We call this license the "Lesser" General Public License because it does Less to protect the user's freedom than the ordinary General Public License. It also provides other free software developers Less of an advantage over competing non-free programs. These disadvantages are the reason we use the ordinary General Public License for many libraries. However, the Lesser license provides advantages in certain special circumstances.

For example, on rare occasions, there may be a special need to encourage the widest possible use of a certain library, so that it becomes a de-facto standard. To achieve this, non-free programs must be allowed to use the library. A more frequent case is that a free library does the same job as widely used non-free libraries. In this case, there is little to gain by limiting the free library to free software only, so we use the Lesser General Public License.

In other cases, permission to use a particular library in non-free programs enables a greater number of people to use a large body of free software. For example, permission to use the GNU C Library in non-free programs enables many more people to use the whole GNU operating system, as well as its variant, the GNU/Linux operating system.

Although the Lesser General Public License is Less protective of the users' freedom, it does ensure that the user of a program that is linked with the Library has the freedom and the wherewithal to run that program using a modified version of the Library.

The precise terms and conditions for copying, distribution and modification follow. Pay close attention to the difference between a "work based on the library" and a "work that uses the library". The former contains code derived from the library, whereas the latter must be combined with the library in order to run.

TERMS AND CONDITIONS FOR COPYING, DISTRIBUTION AND MODIFICATION

0. This License Agreement applies to any software library or other program which contains a notice placed by the copyright holder or other authorized party saying it may be distributed under the terms of this Lesser General Public License (also called "this License"). Each licensee is addressed as "you".

A "library" means a collection of software functions and/or data prepared so as to be conveniently linked with application programs (which use some of those functions and data) to form executables.

The "Library", below, refers to any such software library or work which has been distributed under these terms. A "work based on the Library" means either the Library or any derivative work under copyright law: that is to say, a work containing the Library or a portion of it, either verbatim or with modifications and/or translated straightforwardly into another language. (Hereinafter, translation is included without limitation in the term "modification".)

"Source code" for a work means the preferred form of the work for making modifications to it. For a library, complete source code means all the source code for all modules it contains, plus any associated interface definition files, plus the scripts used to control compilation and installation of the library.

Activities other than copying, distribution and modification are not covered by this License; they are outside its scope. The act of running a program using the Library is not restricted, and output from such a program is covered only if its contents constitute a work based on the Library (independent of the use of the Library in a tool for writing it). Whether that is true depends on what the Library does and what the program that uses the Library does.

1. You may copy and distribute verbatim copies of the Library's complete source code as you receive it, in any medium, provided that you conspicuously and appropriately publish on each copy an appropriate copyright notice and disclaimer of warranty; keep intact all the notices that refer to this License and to the absence of any warranty; and distribute a copy of this License along with the Library.

You may charge a fee for the physical act of transferring a copy, and you may at your option offer warranty protection in exchange for a fee.

2. You may modify your copy or copies of the Library or any portion of it, thus forming a work based on the Library, and copy and distribute such modifications or work under the terms of Section 1 above, provided that you also meet all of these conditions:

- a) The modified work must itself be a software library.
- b) You must cause the files modified to carry prominent notices stating that you changed the files and the date of any change.
- c) You must cause the whole of the work to be licensed at no charge to all third parties under the terms of this License.
- d) If a facility in the modified Library refers to a function or a table of data to be supplied by an application program that uses the facility, other than as an argument passed when the facility is invoked, then you must make a good faith effort to ensure that, in the event an application does not supply such function or table, the facility still operates, and performs whatever part of its purpose remains meaningful.

(For example, a function in a library to compute square roots has a purpose that is entirely well-defined independent of the application. Therefore, Subsection 2d requires that any application-supplied function or table used by this function must be optional: if the application does not supply it, the square root function must still compute square roots.)

These requirements apply to the modified work as a whole. If identifiable sections of that work are not derived from the Library, and can be reasonably considered independent and separate works in themselves, then this License, and its terms, do not apply to those sections when you distribute them as separate works. But when you distribute the same sections as part of a whole which is a work based on the Library, the distribution of the whole must be on the terms of this License, whose permissions for other licensees extend to the entire whole, and thus to each and every part regardless of who wrote it.

Thus, it is not the intent of this section to claim rights or contest your rights to work written entirely by you; rather, the intent is to exercise the right to control the distribution of derivative or collective works based on the Library.

In addition, mere aggregation of another work not based on the Library with the Library (or with a work based on the Library) on a volume of a storage or distribution medium does not bring the other work under the scope of this License.

3. You may opt to apply the terms of the ordinary GNU General Public License instead of this License to a given copy of the Library. To do this, you must alter all the notices that refer to this License, so that they refer to the ordinary GNU General Public License, version 2, instead of to this License. (If a newer version than version 2 of the ordinary GNU General Public License has appeared, then you can specify that version instead if you wish.) Do not make any other change in these notices.

Once this change is made in a given copy, it is irreversible for that copy, so the ordinary GNU General Public License applies to all subsequent copies and derivative works made from that copy.

This option is useful when you wish to copy part of the code of the Library into a program that is not a library.

4. You may copy and distribute the Library (or a portion or derivative of it, under Section 2) in object code or executable form under the terms of Sections 1 and 2 above provided that you accompany it with the complete corresponding machine-readable source code, which must be distributed under the terms of Sections 1 and 2 above on a medium customarily used for software interchange.

If distribution of object code is made by offering access to copy from a designated place, then offering equivalent access to copy the source code from the same place satisfies the requirement to distribute the source code, even though third parties are not compelled to copy the source along with the object code.

5. A program that contains no derivative of any portion of the Library, but is designed to work with the Library by being compiled or linked with it, is called a “work that uses the Library”. Such a work, in isolation, is not a derivative work of the Library, and therefore falls outside the scope of this License.

However, linking a “work that uses the Library” with the Library creates an executable that is a derivative of the Library (because it contains portions of the Library), rather than a “work that uses the library”. The executable is therefore covered by this License. Section 6 states terms for distribution of such executables.

When a “work that uses the Library” uses material from a header file that is part of the Library, the object code for the work may be a derivative work of the Library even though the source code is not. Whether this is true is especially significant if the work can be linked without the Library, or if the work is itself a library. The threshold for this to be true is not precisely defined by law.

If such an object file uses only numerical parameters, data structure layouts and accessors, and small macros and small inline functions (ten lines or less in length), then the use of the object file is unrestricted, regardless of whether it is legally a derivative work. (Executables containing this object code plus portions of the Library will still fall under Section 6.)

Otherwise, if the work is a derivative of the Library, you may distribute the object code for the work under the terms of Section 6. Any executables containing that work also fall under Section 6, whether or not they are linked directly with the Library itself.

6. As an exception to the Sections above, you may also combine or link a “work that uses the Library” with the Library to produce a work containing portions of the Library, and distribute that work under terms of your choice, provided that the terms permit modification of

the work for the customer's own use and reverse engineering for debugging such modifications.

You must give prominent notice with each copy of the work that the Library is used in it and that the Library and its use are covered by this License. You must supply a copy of this License. If the work during execution displays copyright notices, you must include the copyright notice for the Library among them, as well as a reference directing the user to the copy of this License. Also, you must do one of these things:

- a) Accompany the work with the complete corresponding machine-readable source code for the Library including whatever changes were used in the work (which must be distributed under Sections 1 and 2 above); and, if the work is an executable linked with the Library, with the complete machine readable "work that uses the Library", as object code and/or source code, so that the user can modify the Library and then relink to produce a modified executable containing the modified Library. (It is understood that the user who changes the contents of definitions files in the Library will not necessarily be able to recompile the application to use the modified definitions.)
- b) Use a suitable shared library mechanism for linking with the Library. A suitable mechanism is one that (1) uses at run time a copy of the library already present on the user's computer system, rather than copying library functions into the executable, and (2) will operate properly with a modified version of the library, if the user installs one, as long as the modified version is interface-compatible with the version that the work was made with.
- c) Accompany the work with a written offer, valid for at least three years, to give the same user the materials specified in Subsection 6a, above, for a charge no more than the cost of performing this distribution.
- d) If distribution of the work is made by offering access to copy from a designated place, offer equivalent access to copy the above specified materials from the same place.
- e) Verify that the user has already received a copy of these materials or that you have already sent this user a copy.

For an executable, the required form of the "work that uses the Library" must include any data and utility programs needed for reproducing the executable from it. However, as a special exception, the materials to be distributed need not include anything that is normally distributed (in either source or binary form) with the major components (compiler, kernel, and so on) of the operating system on which the executable runs, unless that component itself accompanies the executable.

It may happen that this requirement contradicts the license restrictions of other proprietary libraries that do not normally accompany the operating system. Such a contradiction means you cannot use both them and the Library together in an executable that you distribute.

7. You may place library facilities that are a work based on the Library side-by-side in a single library together with other library facilities not covered by this License, and distribute such a combined library, provided that the separate distribution of the work based on the Library and of the other library facilities is otherwise permitted, and provided that you do these two things:

- a) Accompany the combined library with a copy of the same work based on the Library, uncombined with any other library facilities. This must be distributed under the terms of the Sections above.
- b) Give prominent notice with the combined library of the fact that part of it is a work based on the Library, and explaining where to find the accompanying uncombined form of the same work.

8. You may not copy, modify, sublicense, link with, or distribute the Library except as expressly provided under this License. Any attempt otherwise to copy, modify, sublicense, link with, or distribute the Library is void, and will automatically terminate your rights under this License. However, parties who have received copies, or rights, from you under this License will not have their licenses terminated so long as such parties remain in full compliance.

9. You are not required to accept this License, since you have not signed it. However, nothing else grants you permission to modify or distribute the Library or its derivative works. These actions are prohibited by law if you do not accept this License. Therefore, by modifying or distributing the Library (or any work based on the Library), you indicate your acceptance of this License to do so, and all its terms and conditions for copying, distributing or modifying the Library or works based on it.

10. Each time you redistribute the Library (or any work based on the Library), the recipient automatically receives a license from the original licensor to copy, distribute, link with or modify the Library subject to these terms and conditions. You may not impose any further restrictions on the recipients' exercise of the rights granted herein. You are not responsible for enforcing compliance by third parties with this License.

11. If, as a consequence of a court judgment or allegation of patent infringement or for any other reason (not limited to patent issues), conditions are imposed on you (whether by court order, agreement or otherwise) that contradict the conditions of this License, they do not excuse you from the conditions of this License. If you cannot distribute so as to satisfy simultaneously your obligations under this License and any other pertinent obligations, then as a consequence you may not distribute the Library at all. For example, if a patent license would not permit royalty free redistribution of the Library by all those who receive copies directly or indirectly through you, then the only way you could satisfy both it and this License would be to refrain entirely from distribution of the Library.

If any portion of this section is held invalid or unenforceable under any particular circumstance, the balance of the section is intended to apply, and the section as a whole is intended to apply in other circumstances.

It is not the purpose of this section to induce you to infringe any patents or other property right claims or to contest validity of any such claims; this section has the sole purpose of protecting the integrity of the free software distribution system which is implemented by public license practices. Many people have made generous contributions to the wide range of software distributed through that system in reliance on consistent application of that system; it is up to the author/donor to decide if he or she is willing to distribute software through any other system and a licensee cannot impose that choice.

This section is intended to make thoroughly clear what is believed to be a consequence of the rest of this License.

12. If the distribution and/or use of the Library is restricted in certain countries either by patents or by copyrighted interfaces, the original copyright holder who places the Library under this License may add an explicit geographical distribution limitation excluding those countries, so that distribution is permitted only in or among countries not thus excluded. In such case, this License incorporates the limitation as if written in the body of this License.

13. The Free Software Foundation may publish revised and/or new versions of the Lesser General Public License from time to time. Such new versions will be similar in spirit to the present version, but may differ in detail to address new problems or concerns.

Each version is given a distinguishing version number. If the Library specifies a version number of this License which applies to it and “any later version”, you have the option of following the terms and conditions either of that version or of any later version published by the Free Software Foundation. If the Library does not specify a license version number, you may choose any version ever published by the Free Software Foundation.

14. If you wish to incorporate parts of the Library into other free programs whose distribution conditions are incompatible with these, write to the author to ask for permission. For software which is copyrighted by the Free Software Foundation, write to the Free Software Foundation; we sometimes make exceptions for this. Our decision will be guided by the two goals of preserving the free status of all derivatives of our free software and of promoting the sharing and reuse of software generally.

NO WARRANTY

15. BECAUSE THE LIBRARY IS LICENSED FREE OF CHARGE, THERE IS NO WARRANTY FOR THE LIBRARY, TO THE EXTENT PERMITTED BY APPLICABLE LAW. EXCEPT WHEN OTHERWISE STATED IN WRITING THE COPYRIGHT HOLDERS AND/OR OTHER PARTIES PROVIDE THE LIBRARY “AS IS” WITHOUT WARRANTY OF ANY KIND, EITHER

EXPRESSED OR IMPLIED, INCLUDING, BUT NOT LIMITED TO, THE IMPLIED WARRANTIES OF MERCHANTABILITY AND FITNESS FOR A PARTICULAR PURPOSE. THE ENTIRE RISK AS TO THE QUALITY AND PERFORMANCE OF THE LIBRARY IS WITH YOU. SHOULD THE LIBRARY PROVE DEFECTIVE, YOU ASSUME THE COST OF ALL NECESSARY SERVICING, REPAIR OR CORRECTION.

16. IN NO EVENT UNLESS REQUIRED BY APPLICABLE LAW OR AGREED TO IN WRITING WILL ANY COPYRIGHT HOLDER, OR ANY OTHER PARTY WHO MAY MODIFY AND/OR REDISTRIBUTE THE LIBRARY AS PERMITTED ABOVE, BE LIABLE TO YOU FOR DAMAGES, INCLUDING ANY GENERAL, SPECIAL, INCIDENTAL OR CONSEQUENTIAL DAMAGES ARISING OUT OF THE USE OR INABILITY TO USE THE LIBRARY (INCLUDING BUT NOT LIMITED TO LOSS OF DATA OR DATA BEING RENDERED INACCURATE OR LOSSES SUSTAINED BY YOU OR THIRD PARTIES OR A FAILURE OF THE LIBRARY TO OPERATE WITH ANY OTHER SOFTWARE), EVEN IF SUCH HOLDER OR OTHER PARTY HAS BEEN ADVISED OF THE POSSIBILITY OF SUCH DAMAGES.

END OF TERMS AND CONDITIONS

How to Apply These Terms to Your New Libraries

If you develop a new library, and you want it to be of the greatest possible use to the public, we recommend making it free software that everyone can redistribute and change. You can do so by permitting redistribution under these terms (or, alternatively, under the terms of the ordinary General Public License).

To apply these terms, attach the following notices to the library. It is safest to attach them to the start of each source file to most effectively convey the exclusion of warranty; and each file should have at least the “copyright” line and a pointer to where the full notice is found. one line to give the library’s name and an idea of what it does.

Copyright (C) year name of author

This library is free software; you can redistribute it and/or modify it under the terms of the GNU Lesser General Public License as published by the Free Software Foundation; either version 2.1 of the License, or (at your option) any later version.

This library is distributed in the hope that it will be useful, but WITHOUT ANY WARRANTY; without even the implied warranty of MERCHANTABILITY or FITNESS FOR A PARTICULAR PURPOSE. See the GNU Lesser General Public License for more details.

You should have received a copy of the GNU Lesser General Public License along with this library; if not,

write to the Free Software Foundation, Inc., 51 Franklin Street, Fifth Floor, Boston, MA 02110-1301 USA Also add information on how to contact you by electronic and paper mail.

You should also get your employer (if you work as a programmer) or your school, if any, to sign a "copyright disclaimer" for the library, if necessary. Here is a sample; alter the names:

Yoyodyne, Inc., hereby disclaims all copyright interest in the library 'Frob' (a library for tweaking knobs) written by James Random Hacker.

signature of Ty Coon, 1 April 1990 Ty Coon, President of Vice.

OpenSSL LICENSE

Copyright (c) 1998-2006 The OpenSSL Project. All rights reserved. Redistribution and use in source and binary forms, with or without modification, are permitted provided that the following conditions are met:

1. Redistributions of source code must retain the above copyright notice, this list of conditions and the following disclaimer.
2. Redistributions in binary form must reproduce the above copyright notice, this list of conditions and the following disclaimer in the documentation and/or other materials provided with the distribution.
3. All advertising materials mentioning features or use of this software must display the following acknowledgment: "This product includes software developed by the OpenSSL Project for use in the OpenSSL Toolkit. (<http://www.openssl.org/>)"
4. The names "OpenSSL Toolkit" and "OpenSSL Project" must not be used to endorse or promote products derived from this software without prior written permission. For written permission, please contact openssl-core@openssl.org.
5. Products derived from this software may not be called "OpenSSL" nor may "OpenSSL" appear in their names without prior written permission of the OpenSSL Project.
6. Redistributions of any form whatsoever must retain the following acknowledgment: "This product includes software developed by the OpenSSL Project for use in the OpenSSL Toolkit (<http://www.openssl.org/>)"

THIS SOFTWARE IS PROVIDED BY THE OpenSSL PROJECT "AS IS" AND ANY EXPRESSED OR IMPLIED WARRANTIES, INCLUDING, BUT NOT LIMITED TO, THE IMPLIED WARRANTIES OF MERCHANTABILITY AND FITNESS FOR A PARTICULAR PURPOSE ARE DISCLAIMED. IN NO EVENT SHALL THE OpenSSL PROJECT OR ITS CONTRIBUTORS BE LIABLE FOR ANY DIRECT, INDIRECT, INCIDENTAL, SPECIAL, EXEMPLARY, OR CONSEQUENTIAL DAMAGES (INCLUDING, BUT NOT LIMITED TO, PROCUREMENT OF SUBSTITUTE GOODS OR SERVICES; LOSS OF USE, DATA, OR PROFITS; OR BUSINESS INTERRUPTION) HOWEVER CAUSED AND ON ANY THEORY OF LIABILITY, WHETHER IN CONTRACT, STRICT LIABILITY, OR

TORT (INCLUDING NEGLIGENCE OR OTHERWISE) ARISING IN ANY WAY OUT OF THE USE OF THIS SOFTWARE, EVEN IF ADVISED OF THE POSSIBILITY OF SUCH DAMAGE. This product includes cryptographic software written by Eric Young (eay@cryptsoft.com). This product includes software written by Tim Hudson (tjh@cryptsoft.com).

Original SSLeay License

Copyright (C) 1995-1998 Eric Young (eay@cryptsoft.com). All rights reserved. This package is an SSL implementation written by Eric Young (eay@cryptsoft.com). The implementation was written so as to conform with Netscapes SSL. This library is free for commercial and non-commercial use as long as the following conditions are adhered to. The following conditions apply to all code found in this distribution, be it the RC4, RSA, lhash, DES, etc., code; not just the SSL code. The SSL documentation included with this distribution is covered by the same copyright terms except that the holder is Tim Hudson (tjh@cryptsoft.com).

Copyright remains Eric Young's, and as such any Copyright notices in the code are not to be removed. If this package is used in a product, Eric Young should be given attribution as the author of the parts of the library used. This can be in the form of a textual message at program startup or in documentation (online or textual) provided with the package. Redistribution and use in source and binary forms, with or without modification, are permitted provided that the following conditions are met:

1. Redistributions of source code must retain the copyright notice, this list of conditions and the following disclaimer.
2. Redistributions in binary form must reproduce the above copyright notice, this list of conditions and the following disclaimer in the documentation and/or other materials provided with the distribution.
3. All advertising materials mentioning features or use of this software must display the following acknowledgement: "This product includes cryptographic software written by Eric Young (eay@cryptsoft.com)" The word 'cryptographic' can be left out if the routines from the library being used are not cryptographic related :-).
4. If you include any Windows specific code (or a derivative thereof) from the apps directory (application code) you must include an acknowledgement: "This product includes software written by Tim Hudson (tjh@cryptsoft.com)"

THIS SOFTWARE IS PROVIDED BY ERIC YOUNG "AS IS" AND ANY EXPRESS OR IMPLIED WARRANTIES, INCLUDING, BUT NOT LIMITED TO, THE IMPLIED WARRANTIES OF MERCHANTABILITY AND FITNESS FOR A PARTICULAR PURPOSE ARE DISCLAIMED. IN NO EVENT SHALL THE AUTHOR OR CONTRIBUTORS BE LIABLE FOR ANY DIRECT, INDIRECT, INCIDENTAL, SPECIAL, EXEMPLARY, OR CONSEQUENTIAL DAMAGES (INCLUDING, BUT NOT LIMITED TO, PROCUREMENT OF SUBSTITUTE GOODS OR SERVICES; LOSS OF USE, DATA, OR

PROFITS; OR BUSINESS INTERRUPTION) HOWEVER CAUSED AND ON ANY THEORY OF LIABILITY, WHETHER IN CONTRACT, STRICT LIABILITY, OR TORT (INCLUDING NEGLIGENCE OR OTHERWISE) ARISING IN ANY WAY OUT OF THE USE OF THIS SOFTWARE, EVEN IF ADVISED OF THE POSSIBILITY OF SUCH DAMAGE. The licence and distribution terms for any publically available version or derivative of this code cannot be changed. i.e. this code cannot simply be copied and put under another distribution licence [including the GNU Public Licence.



Correct Disposal of This Product (Waste Electrical & Electronic Equipment)

(Applicable in the European Union and other European countries with separate collection systems)

This marking on the product, accessories or literature indicates that the product and its electronic accessories (e.g. charger, headset, USB cable) should not be disposed of with other household waste at the end of their working life. To prevent possible harm to the environment or human health from uncontrolled waste disposal, please separate these items from other types of waste and recycle them responsibly to promote the sustainable reuse of material resources.

Household users should contact either the retailer where they purchased this product, or their local government office, for details of where and how they can take these items for environmentally safe recycling.

Business users should contact their supplier and check the terms and conditions of the purchase contract. This product and its electronic accessories should not be mixed with other commercial wastes for disposal.



Correct disposal of batteries in this product

(Applicable in the European Union and other European countries with separate battery return systems.)

This marking on the battery, manual or packaging indicates that the batteries in this product should not be disposed of with other household waste at the end of their working life. Where marked, the chemical symbols Hg, Cd or Pb indicate that the battery contains mercury, cadmium or lead above the reference levels in EC Directive 2006/66. If batteries are not properly disposed of, these substances can cause harm to human health or the environment.

To protect natural resources and to promote material reuse, please separate batteries from other types of waste and recycle them through your local, free battery return system.

SAMSUNG TECHWIN



SALES NETWORK

SAMSUNG TECHWIN CO., LTD.

Samsungtechwin R&D Center, 701, Sampyong-dong, Bundang-gu, Seongnam-si, Gyeonggi-do, Korea, 463-400
TEL : +82-70-7147-8740~60 FAX : +82-31-8018-3745

SAMSUNG TECHWIN AMERICA Inc.

1480 Charles Willard St, Carson, CA 90746, UNITED STATES
Tol Free : +1-877-213-1222 FAX : +1-310-632-2195
www.samsungcctvusa.com

SAMSUNG TECHWIN EUROPE LTD.

Samsung House, 1000 Hillswood Drive, Hillswood Business
Park Chertsey, Surrey, UNITED KINGDOM KT16 OPS
TEL : +44-1932-45-5300 FAX : +44-1932-45-5325

www.samsungsecurity.com
www.samsungipolis.com

P/No. : Z6809128901A-00