

TP-LINK®

User Guide

TL-SL2218/TL-SL2428

Smart Switch



COPYRIGHT & TRADEMARKS

Specifications are subject to change without notice. **TP-LINK®** is a registered trademark of TP-LINK TECHNOLOGIES CO., LTD. Other brands and product names are trademarks or registered trademarks of their respective holders.

No part of the specifications may be reproduced in any form or by any means or used to make any derivative such as translation, transformation, or adaptation without permission from TP-LINK TECHNOLOGIES CO., LTD. Copyright © 2013 TP-LINK TECHNOLOGIES CO., LTD. All rights reserved.

<http://www.tp-link.com>

FCC STATEMENT



This equipment has been tested and found to comply with the limits for a Class A digital device, pursuant to part 15 of the FCC Rules. These limits are designed to provide reasonable protection against harmful interference when the equipment is operated in a commercial environment. This equipment generates, uses, and can radiate radio frequency energy and, if not installed and used in accordance with the instruction manual, may cause harmful interference to radio communications. Operation of this equipment in a residential area is likely to cause harmful interference in which case the user will be required to correct the interference at his own expense.

This device complies with part 15 of the FCC Rules. Operation is subject to the following two conditions:

- 1) This device may not cause harmful interference.
- 2) This device must accept any interference received, including interference that may cause undesired operation.

Any changes or modifications not expressly approved by the party responsible for compliance could void the user's authority to operate the equipment.

CE Mark Warning



This is a Class A product. In a domestic environment, this product may cause radio interference, in which case the user may be required to take adequate measures.



Продукт сертифіковано згідно с правилами системи УкрСЕПРО на відповідність вимогам нормативних документів та вимогам, що передбачені чинними законодавчими актами України.

Safety Information

- When product has power button, the power button is one of the way to shut off the product; When there is no power button, the only way to completely shut off power is to disconnect the product or the power adapter from the power source.
- Don't disassemble the product, or make repairs yourself. You run the risk of electric shock and voiding the limited warranty. If you need service, please contact us.
- Avoid water and wet locations.

This product can be used in the following countries:

AT	BG	BY	CA	CZ	DE	DK	EE
ES	FI	FR	GB	GR	HU	IE	IT
LT	LV	MT	NL	NO	PL	PT	RO
RU	SE	SK	TR	UA			

CONTENTS

Package Contents	1
Chapter 1 About this Guide	2
1.1 Intended Readers	2
1.2 Conventions.....	2
1.3 Overview of This Guide	2
Chapter 2 Introduction	5
2.1 Overview of the Switch	5
2.2 Main Features.....	5
2.3 Appearance Description	5
2.3.1 Front Panel	5
2.3.2 Rear Panel.....	7
Chapter 3 Login to the Switch.....	8
3.1 Login.....	8
3.2 Configuration	8
Chapter 4 System.....	10
4.1 System Info.....	10
4.1.1 System Summary.....	10
4.1.2 Device Description	12
4.1.3 System Time	13
4.1.4 Daylight Saving Time	13
4.1.5 System IP.....	15
4.2 User Management	16
4.2.1 User Table.....	16
4.2.2 User Config	16
4.3 System Tools	18
4.3.1 Config Restore	18
4.3.2 Config Backup.....	18
4.3.3 Firmware Upgrade	19
4.3.4 System Reboot	20
4.3.5 System Reset.....	20
4.4 Access Security	20
Chapter 5 Switching	23
5.1 Port.....	23
5.1.1 Port Config.....	23
5.1.2 Port Mirror	24

5.1.3	Port Security	27
5.1.4	Port Isolation	29
5.2	LAG	30
5.2.1	LAG Table	30
5.2.2	Static LAG	32
5.3	Traffic Monitor	33
5.3.1	Traffic Summary	33
5.3.2	Traffic Statistics	34
5.4	MAC Address	36
5.4.1	Address Table	36
5.4.2	Static Address	38
5.4.3	Dynamic Address	39
5.4.4	Filtering Address	41
Chapter 6	VLAN	43
6.1	802.1Q VLAN	44
6.1.1	VLAN Config	46
6.1.2	Port Config	48
6.2	Application Example for 802.1Q VLAN	50
Chapter 7	Spanning Tree	52
7.1	STP Config	57
7.1.1	STP Config	57
7.1.2	STP Summary	59
7.2	Port Config	60
7.3	MSTP Instance	62
7.3.1	Region Config	62
7.3.2	Instance Config	63
7.3.3	Instance Port Config	64
7.4	STP Security	66
7.4.1	Port Protect	66
7.4.2	TC Protect	69
7.5	Application Example for STP Function	69
Chapter 8	Multicast	73
8.1	IGMP Snooping	75
8.1.1	Snooping Config	76
8.1.2	Port Config	77

8.1.3	VLAN Config	78
8.1.4	Multicast VLAN	80
8.2	Multicast IP	83
8.2.1	Multicast IP Table	84
8.2.2	Static Multicast IP	84
8.3	Multicast Filter	85
8.3.1	IP-Range	86
8.3.2	Port Filter	87
8.4	Packet Statistics	88
Chapter 9	QoS	90
9.1	DiffServ	93
9.1.1	Port Priority	93
9.1.2	802.1P Priority	94
9.1.3	DSCP Priority	95
9.1.4	Schedule Mode	97
9.2	Bandwidth Control	98
9.2.1	Rate Limit	98
9.2.2	Storm Control	100
Chapter 10	SNMP	102
10.1	SNMP Config	104
10.1.1	Global Config	104
10.1.2	SNMP View	105
10.1.3	SNMP Group	106
10.1.4	SNMP User	108
10.1.5	SNMP Community	109
10.2	Notification	111
10.3	RMON	113
10.3.1	History Control	114
10.3.2	Event Config	115
10.3.3	Alarm Config	116
Chapter 11	Maintenance	118
11.1	System Monitor	118
11.1.1	CPU Monitor	118
11.1.2	Memory Monitor	119
11.2	Log	120

11.2.1	Log Table	121
11.2.2	Local Log	122
11.2.3	Remote Log	122
11.2.4	Backup Log	123
11.3	Device Diagnostics	124
11.3.1	Cable Test	124
11.3.2	Loopback	125
11.4	Network Diagnostics	126
11.4.1	Ping.....	126
11.4.2	Tracert.....	127
Appendix A:	Specifications	128
Appendix B:	Configuring the PCs	129
Appendix C:	Glossary.....	132

Package Contents

The following items should be found in your box:

- One TL-SL2218 /TL-SL2428 Smart Switch
- One power cord
- Two mounting brackets and other fittings
- Installation Guide
- Resource CD for TL-SL2218 /TL-SL2428 Smart Switch, including:
 - This User Guide
 - Other Helpful Information



Note:

Make sure that the package contains the above items. If any of the listed items are damaged or missing, please contact your distributor.

Chapter 1 About this Guide

This User Guide contains information for setup and management of TL-SL2218 16-Port 10/100Mbps + 2-Port Gigabit Smart Switch and TL-SL2428 24-Port 10/100Mbps + 4-Port Gigabit Smart Switch. Please read this guide carefully before operation.

1.1 Intended Readers



This Guide is intended for network managers familiar with IT concepts and network terminologies.

1.2 Conventions

In this Guide the following conventions are used:

- The two devices of TL-SL2218 and TL-SL2428 are sharing this User Guide. For simplicity, we will take TL-SL2428 for example throughout the configuration chapters. TL-SL2218 and TL-SL2428 just differ in the number of LED indicators and ports and all figures in this guide are of TL-SL2428.
- The switch or TL-SL2218/TL-SL2428 mentioned in this Guide stands for TL-SL2218/TL-SL2428 Smart Switch without any explanation.
- **Menu Name**→**Submenu Name**→**Tab page** indicates the menu structure. **System**→**System Info**→**System Summary** means the System Summary page under the System Info menu option that is located under the System menu.
- **Bold font** indicates a button, a toolbar icon, menu or menu item.

Symbols in this Guide:

Symbol	Description
 Note:	Ignoring this type of note might result in a malfunction or damage to the device.
 Tips:	This format indicates important information that helps you make better use of your device.

1.3 Overview of This Guide

Chapter	Introduction
Chapter 1 About This Guide	Introduces the guide structure and conventions.
Chapter 2 Introduction	Introduces the features, application and appearance of TL-SL2218/TL-SL2428 switch.
Chapter 3 Login to the Switch	Introduces how to log on to TL-SL2218/TL-SL2428 Web management page.

Chapter	Introduction
Chapter 4 System	<p>This module is used to configure system properties of the switch. Here mainly introduces:</p> <ul style="list-style-type: none"> ● System Info: Configure the description, system time, Daylight Saving Time and network parameters of the switch. ● User Management: Configure the user name and password for users to log on to the Web management page with a certain access level. ● System Tools: Manage the configuration file of the switch. ● Access Security: Access Security is configured to control the users logging on to the Web management page.
Chapter 5 Switching	<p>This module is used to configure basic functions of the switch. Here mainly introduces:</p> <ul style="list-style-type: none"> ● Port: Configure the basic features for the port. ● LAG: Configure Link Aggregation Group. LAG is to combine a number of ports together to make a single high-bandwidth data path. ● Traffic Monitor: Monitor the traffic of each port. ● MAC Address: Configure the address table of the switch.
Chapter 6 VLAN	<p>This module is used to configure VLANs to control broadcast in LANs. Here mainly introduces:</p> <ul style="list-style-type: none"> ● 802.1Q VLAN: Configure port-based VLAN.
Chapter 7 Spanning Tree	<p>This module is used to configure spanning tree function of the switch. Here mainly introduces:</p> <ul style="list-style-type: none"> ● STP Config: Configure and view the global settings of spanning tree function. ● Port Config: Configure CIST parameters of ports. ● MSTP Instance: Configure MSTP instances. ● STP Security: Configure protection function to prevent devices from any malicious attack against STP features.
Chapter 8 Multicast	<p>This module is used to configure multicast function of the switch. Here mainly introduces:</p> <ul style="list-style-type: none"> ● IGMP Snooping: Configure global parameters of IGMP Snooping function, port properties, VLAN and multicast VLAN. ● Multicast IP: Configure multicast IP table. ● Multicast Filter: Configure multicast filter feature to restrict users ordering multicast programs. ● Packet Statistics: View the multicast data traffic on each port of the switch, which facilitates you to monitor the IGMP messages in the network.

Chapter	Introduction
Chapter 9 QoS	<p>This module is used to configure QoS function to provide different quality of service for various network applications and requirements. Here mainly introduces:</p> <ul style="list-style-type: none"> ● DiffServ: Configure priorities, port priority, 802.1P priority and DSCP priority. ● Bandwidth Control: Configure rate limit feature to control the traffic rate on each port; configure storm control feature to filter broadcast, multicast and UL frame in the network.
Chapter 10 SNMP	<p>This module is used to configure SNMP function to provide a management frame to monitor and maintain the network devices. Here mainly introduces:</p> <ul style="list-style-type: none"> ● SNMP Config: Configure global settings of SNMP function. ● Notification: Configure notification function for the management station to monitor and process the events. ● RMON: Configure RMON function to monitor network more efficiently.
Chapter 11 Maintenance	<p>This module is used to assemble the commonly used system tools to manage the switch. Here mainly introduces:</p> <ul style="list-style-type: none"> ● System Monitor: Monitor the memory and CPU of the switch. ● Log: View configuration parameters on the switch. ● Device Diagnostics: <ul style="list-style-type: none"> ➢ Cable Test: Test the connection status of the cable connected to the switch. ➢ Loopback: Test if the port of the switch and the connected device are available. ● Network Diagnostics: Test if the destination is reachable and the account of router hops from the switch to the destination.
Appendix A Specifications	Lists the hardware specifications of the Switch.
Appendix B Configure the PCs	Introduces how to configure the PCs.
Appendix C Glossary	Lists the glossary used in this manual.

[Return to CONTENTS](#)

Chapter 2 Introduction

Thanks for choosing the TL-SL2218/TL-SL2428 Smart Switch!

2.1 Overview of the Switch

Designed for workgroups and departments, TL-SL2218/TL-SL2428 from TP-LINK provides wire-speed performance and full set of layer 2 management features. They provide a variety of service features and multiple powerful functions with high security.

The EIA-standardized framework and smart configuration capacity can provide flexible solutions for a variable scale of networks. QoS and IGMP snooping/filtering optimize voice and video application. SNMP, RMON, WEB Log-in bring abundant management policies. TL-SL2218/TL-SL2428 Switch integrate multiple functions with excellent performance, and are friendly to manage, which can fully meet the need of the users demanding higher networking performance.

2.2 Main Features

- **Resiliency and Availability**

- + IEEE 802.1s Multiple Spanning Tree provides high link availability in multiple VLAN environments.
- + Multicast snooping automatically prevents flooding of IP multicast traffic.
- + Root Guard protects root bridge from malicious attack or configuration mistakes.

- **Layer 2 Switching**

- + Supports 255 active VLAN groups and 4K VLAN IDs.

- **Quality of Service**

- + Supports L2/L3 granular CoS with 4 priority queues per port.
- + Rate limiting confines the traffic flow accurately according to the preset value.

- **Security**

- + Control the users logging on to the Web management page.

- **Manageability**

- + Supports SNMP v1/v2c/v3, RMON and web access.
- + Port Mirroring enables monitoring selected ingress/egress traffic.

2.3 Appearance Description

2.3.1 Front Panel

The front panel of TL-SL2218 is shown as Figure 2-1.

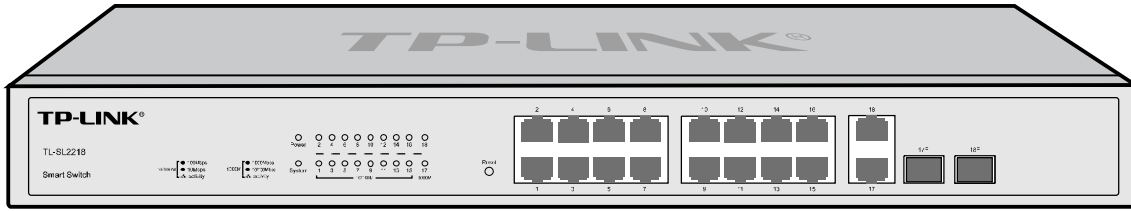

Figure 2-1 Front Panel of TL-SL2218

The front panel of TL-SL2428 is shown as Figure 2-2.

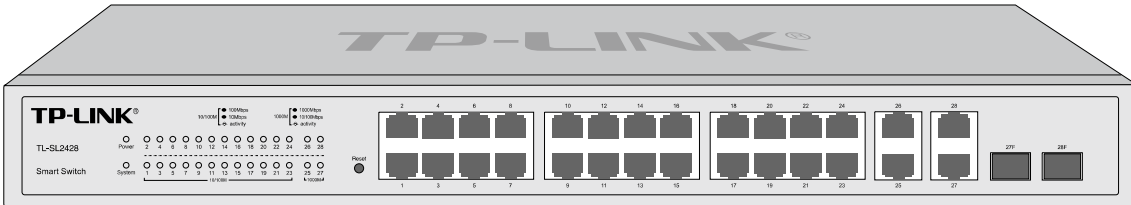

Figure 2-2 Front Panel of TL-SL2428

The following parts are located on the front panel of the Switch:

- **Reset:** With the Switch powered on, press **Reset** button for five seconds to reset the software setting to its factory default settings.
- **10/100Mbps Ports:** Designed to connect to the device with a bandwidth of 10Mbps or 100Mbps. Each has a corresponding 10/100M LED.
- **10/100/1000Mbps Ports:** Designed to connect to the device with a bandwidth of 10Mbps, 100Mbps or 1000Mbps. Each has a corresponding 1000M LED.
- **SFP Ports:** Designed to install the SFP module. It shares LEDs with 1000Mbps ports. When a 1000Mbps SFP module is inserted into the SFP port, On (green) LED of 1000M means a device is linked to the port and Flashing (green) LED of 1000M indicates data is being transmitted or received on the port.
- **LEDs**

Name	Status	Indication
Power	On(green)	The Switch is powered on.
	Flashing/Off	The Switch is powered off or power supply is abnormal.
System	Flashing	The Switch is working normally.
	On/Off	The Switch is powered off or the Switch is working abnormally.
10/100M	On	A device is linked to the corresponding port.
	Flashing	Data is being transmitted or received.
	Green	The linked device is running at 100Mbps.
	Yellow	The linked device is running at 10Mbps.
1000M	On	A device is linked to the corresponding port.
	Flashing	Data is being transmitted or received.
	Green	The linked device is running at 1000Mbps.
	Yellow	The linked device is running at 10/100Mbps.



Note:

When using the SFP port with a 100M module or a gigabit module, you need to log on to the GUI (Graphical User Interface) of the Switch and configure its corresponding Speed and Duplex mode on **Switching** → **Port** → **Port Config** page. For 100M module, please select 100MFD while select 1000MFD for gigabit module. By default, the Speed and Duplex mode of SFP port is 1000MFD.

2.3.2 Rear Panel

The rear panel of TL-SL2218/TL-SL2428 features a power socket and a Grounding Terminal (marked with ⊕). The rear panel of TL-SL2218 is shown as the following figure.

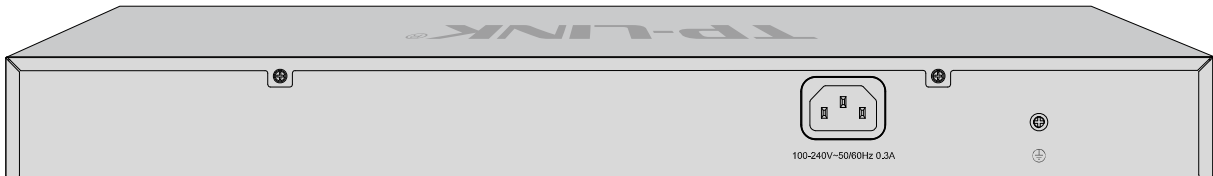

Figure 2-3 Rear Panel of TL-SL2218

The rear panel of TL-SL2428 is shown as the following figure.

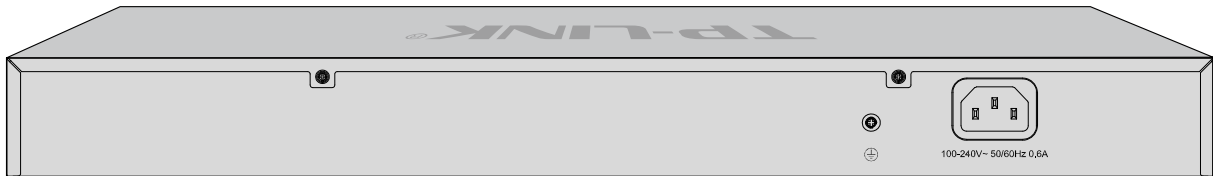

Figure 2-4 Rear Panel of TL-SL2428

- **Grounding Terminal:** TL-SL2218 and TL-SL2428 already come with Lightning Protection Mechanism. You can also ground the Switch through the PE (Protecting Earth) cable of AC cord or with Ground Cable. For detail information, please refer to **Installation Guide**.
- **AC Power Socket:** Connect the female connector of the power cord here, and the male connector to the AC power outlet. Please make sure the voltage of the power supply meets the requirement of the input voltage (100-240V~ 50/60Hz 0.3A for TL-SL2218 and 100-240V~ 50/60Hz 0.6A for TL-SL2428).

[Return to CONTENTS](#)

Chapter 3 Login to the Switch

3.1 Login

- 1) To access the configuration utility, open a web-browser and type in the default address `http://192.168.0.1` in the address field of the browser, then press the **Enter** key.



Figure 3-1 Web-browser



Tips:

To log in to the Switch, the IP address of your PC should be set in the same subnet addresses of the Switch. The IP address is 192.168.0.x ("x" is any number from 2 to 254), Subnet Mask is 255.255.255.0. For the detailed instructions as to how to do this, please refer to Appendix B.

- 2) After a moment, a login window will appear, as shown in Figure 3-2. Enter **admin** for the User Name and Password, both in lower case letters. Then click the **Login** button or press the **Enter** key.

A screenshot of the TP-LINK login page. At the top, there is a dark blue header with the "TP-LINK" logo in white. Below the header, the page has a light blue background. There are two input fields: "User Name:" with the text "admin" entered, and "Password:" with "*****" entered. Below these fields are two buttons: "Login" and "Clear".

Copyright © 2012 TP-LINK Technologies Co., Ltd.
All rights reserved

Figure 3-2 Login

3.2 Configuration

After a successful login, the main page will appear as Figure 3-3, and you can configure the function by clicking the setup menu on the left side of the screen.

TP-LINK

TL-SL2428

System Summary | Device Description | System Time | Daylight Saving Time | System IP

System

- System Info
- User Management
- System Tools
- Access Security

Switching

VLAN

Spanning Tree

Multicast

QoS

SNMP

Maintenance

Save Config

Logout

Copyright © 2012
TP-LINK Technologies Co.,
Ltd. All rights reserved.

2 4 6 8 10 12 14 16 18 20 22 24 26 28 28F
1 3 5 7 9 11 13 15 17 19 21 23 25 27 27F

System Info

System Description:	24FE+4GE Smart Switch
Device Name:	TL-SL2428
Device Location:	SHENZHEN
System Contact:	www.tp-link.com
Hardware Version:	TL-SL2428 1.0
Firmware Version:	1.0.0 Build 20120822 Rel.54711
IP Address:	192.168.0.1
Subnet Mask:	255.255.255.0
Default Gateway:	
MAC Address:	64-70-02-81-54-87
System Time:	2006-01-01 08:25:29
Run Time:	0 day - 0 hour - 25 min - 29 sec

Refresh Help

Figure 3-3 Main Setup-Menu

Note:

Clicking **Apply** can only make the new configurations effective before the switch is rebooted. If you want to keep the configurations effective even the switch is rebooted, please click **Save Config**. You are suggested to click **Save Config** before cutting off the power or rebooting the switch to avoid losing the new configurations.

[Return to CONTENTS](#)

Chapter 4 System

The System module is mainly for system configuration of the switch, including four submenus: **System Info**, **User Management**, **System Tools** and **Access Security**.

4.1 System Info

The System Info, mainly for basic properties configuration, can be implemented on **System Summary**, **Device Description**, **System Time**, **Daylight Saving Time** and **System IP** pages.

4.1.1 System Summary

On this page you can view the port connection status and the system information.

The port status diagram shows the working status of 24 10/100Mbps RJ45 ports, 4 10/100/1000Mbps RJ45 ports and 2 SFP ports of the switch. The ports labeled as 1-24 are 10/100Mbps ports; the ports labeled as 26-28 are 10/100/1000Mbps ports; the ports labeled as 27F and 28F are SFP ports.

Choose the menu **System**→**System Info**→**System Summary** to load the following page.

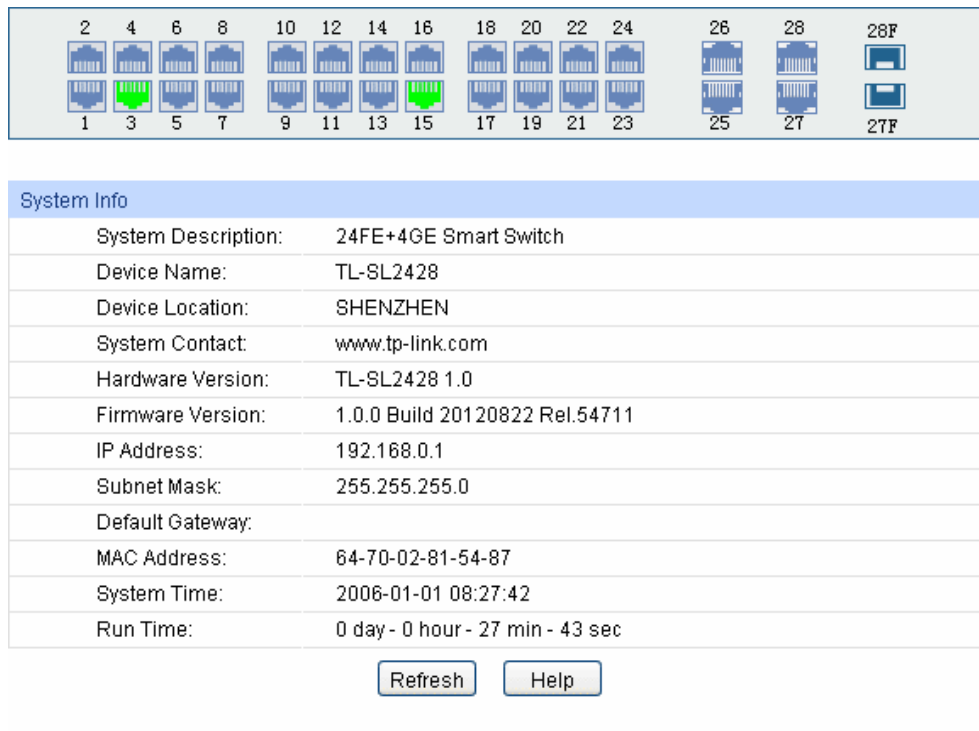

Figure 4-1 System Summary

> Port Status



Indicates the 100Mbps port is not connected to a device.



Indicates the 100Mbps port is at the speed of 100Mbps.



Indicates the 100Mbps port is at the speed of 10Mbps.



Indicates the 1000Mbps port is not connected to a device.



Indicates the 1000Mbps port is at the speed of 1000Mbps.



Indicates the 1000Mbps port is at the speed of 10Mbps or 100Mbps.



Indicates the SFP port is not connected to a device.



Indicates the SFP port is at the speed of 1000Mbps.



Indicates the SFP port is at the speed of 100Mbps.

When the cursor moves on the port, the detailed information of the port will be displayed.

Port: 15
Type: 100M RJ45 Speed: 100M, FullDuplex Status: Connected, Enable

Figure 4-2 Port Information

➤ **Port Info**

Port: Displays the port number of the switch.

Type: Displays the type of the port.

Speed: Displays the maximum transmission speed of the port.

Status: Displays the connection status of the port.

Click a port to display the bandwidth utilization on this port. The actual rate divided by theoretical maximum rate is the bandwidth utilization. Figure 4-3 displays the bandwidth utilization monitored every four seconds. Monitoring the bandwidth utilization on each port facilitates you to monitor the network traffic and analyze the network abnormalities.

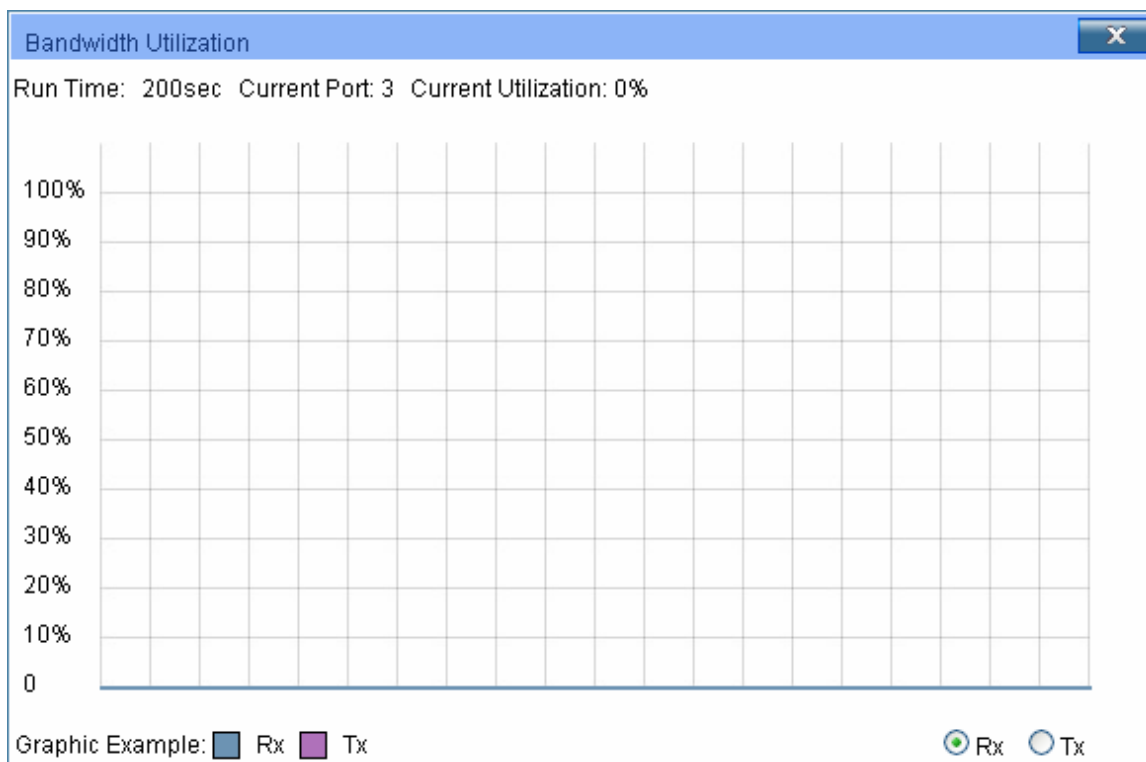

Figure 4-3 Bandwidth Utilization

➤ **Bandwidth Utilization**

Rx: Select Rx to display the bandwidth utilization of receiving packets on this port.

Tx: Select Tx to display the bandwidth utilization of sending packets on this port.

4.1.2 Device Description

On this page you can configure the description of the switch, including device name, device location and system contact.

Choose the menu **System**→**System Info**→**Device Description** to load the following page.

The image shows a "Device Description" configuration form. It has a light blue header with the text "Device Description". Below the header are three input fields: "Device Name" with the value "TL-SL2428", "Device Location" with the value "SHENZHEN", and "System Contact" with the value "www.tp-link.com". To the right of the "Device Location" field is an "Apply" button.

Note:
The Device Name, Location and Contact should be not more than 32 characters.

Figure 4-4 Device Description

The following entries are displayed on this screen:

➤ **Device Description**

Device Name: Enter the name of the switch.

Device Location: Enter the location of the switch.

System Contact: Enter your contact information.

4.1.3 System Time

System Time is the time displayed while the switch is running. On this page you can configure the system time and the settings here will be used for other time-based functions like ACL.

You can manually set the system time, or synchronize with PC's clock as the system time.

Choose the menu **System**→**System Info**→**System Time** to load the following page.

Time Info

Current System Date: 2006-01-01 08:31:40 Sunday

Current Time Source: Manual

Time Config

Manual

Date: 2006 01 01

Time: 08 31 40

Synchronize with PC's Clock

Apply

Refresh

Help

Figure 4-5 System Time

The following entries are displayed on this screen:

➤ **Time Info**

Current System Date: Displays the current date and time of the switch.

Current Time Source: Displays the current time source of the switch.

➤ **Time Config**

Manual: When this option is selected, you can set the date and time manually.

Synchronize with PC'S Clock: When this option is selected, the administrator PC's clock is utilized.



Note:

The system time will be restored to the default when the switch is restarted and you need to reconfigure the system time of the switch.

4.1.4 Daylight Saving Time

On this page you can configure the Daylight Saving Time of the switch, including DST Status, Predefined Mode, Recurring Mode and Date Mode.

Choose the menu **System**→**System Info**→**Daylight Saving Time** to load the following page.

DST Config

DST Status: Disable ▼

Predefined Mode

USA
 Australia
 European
 New Zealand

Recurring Mode

Offset: 60 (minutes)

Start Time: Week Last ▼ Day Sun. ▼ Month Mar. ▼ 01:00

End Time: Week Last ▼ Day Sun. ▼ Month Oct. ▼ 01:00

Date Mode

Offset: 60 (minutes)

Start Time: Apr. ▼ 01 ▼ 00:00 (MM/DD HH:MM)

End Time: Oct. ▼ 01 ▼ 00:00 (MM/DD HH:MM)

Apply
Help

Figure 4-6 System Time

The following entries are displayed on this screen:

- DST Status:** Enable or Disable the DST.
- Predefined Mode:** Select a predefined DST configuration.
- USA: First Sunday in April, 02:00 ~ Last Sunday in October, 02:00.
 - Australia: First Sunday in October, 02:00 ~ First Sunday in April, 03:00.
 - European: Last Sunday in March, 01:00 ~ Last Sunday in October, 01:00.
 - New Zealand: First Sunday in October, 02:00 ~ Last Sunday in March, 03:00.
- Recurring Mode:** Specify the DST configuration in recurring mode. This configuration is recurring in use.
- Offset: Specify the time adding in minutes when Daylight Saving Time comes.
 - Start/End Time: Select starting time and ending time of Daylight Saving Time.
- Date Mode:** Specify the DST configuration in Date mode. This configuration is one-off in use.
- Offset: Specify the time adding in minutes when Daylight Saving Time comes.
 - Start/End Time: Select starting time and ending time of Daylight Saving Time.

Note:

1. When the DST is disabled, the predefined mode, recurring mode and date mode cannot be configured.
2. When the DST is enabled, the default daylight saving time is of European in predefined mode.

4.1.5 System IP

Each device in the network possesses a unique IP Address. You can log on to the Web management page to operate the switch using this IP Address. The switch supports three modes to obtain an IP address: Static IP, DHCP and BOOTP. The IP address obtained using a new mode will replace the original IP address. On this page you can configure the system IP of the switch.

Choose the menu **System**→**System Info**→**System IP** to load the following page.

IP Config

MAC Address: 64-70-02-81-54-87

IP Address Mode: Static IP DHCP BOOTP

Management VLAN: (VLAN ID: 1-4094)

IP Address:

Subnet Mask:

Default Gateway:

Apply Help

Note:

Changing IP address to a different IP segment will interrupt the network communication, so please keep the new IP address in the same IP segment with the local network.

Figure 4-7 System IP

The following entries are displayed on this screen:

➤ **IP Config**

- MAC Address:** Displays MAC Address of the switch.
- IP Address Mode:** Select the mode to obtain IP Address for the switch.
- Static IP: When this option is selected, you should enter IP Address, Subnet Mask and Default Gateway manually.
 - DHCP: When this option is selected, the switch will obtain network parameters from the DHCP Server.
 - BOOTP: When this option is selected, the switch will obtain network parameters from the BOOTP Server.
- Management VLAN:** Enter the ID of management VLAN, the only VLAN through which you can get access to the switch. By default VLAN1 owning all the ports is the Management VLAN and you can access the switch via any port on the switch. However, if another VLAN is created and set to be the Management VLAN, you may have to reconnect the management station to a port that is a member of the Management VLAN.
- IP Address:** Enter the system IP of the switch. The default system IP is 192.168.0.1 and you can change it appropriate to your needs.
- Subnet Mask:** Enter the subnet mask of the switch.
- Default Gateway:** Enter the default gateway of the switch.



Note:

3. Changing the IP address to a different IP segment will interrupt the network communication, so please keep the new IP address in the same IP segment with the local network.
4. The switch only possesses an IP address. The IP address configured will replace the original IP address.
5. If the switch gets the IP address from DHCP server, you can see the configuration of the switch in the DHCP server; if DHCP option is selected but no DHCP server exists in the network, the switch will keep obtaining IP address from DHCP server until success.
6. If DHCP or BOOTP option is selected, the switch will gets network parameters dynamically from the Internet, so IP address, subnet mask and default gateway can not be configured.
7. By default, the default IP address is 192.168.0.1.

4.2 User Management

User Management functions to configure the user name and password for users to log on to the Web management page with a certain access level so as to protect the settings of the switch from being randomly changed.

The User Management function can be implemented on **User Table** and **User Config** pages.

4.2.1 User Table

On this page you can view the information about the current users of the switch.

Choose the menu **System**→**User Management**→**User Table** to load the following page.

User Table			
User ID	User Name	Access Level	Status
1	admin	Admin	Enable

Figure 4-8 User Table

4.2.2 User Config

On this page you can configure the access level of the user to log on to the Web management page. The switch provides two access levels: Guest and Admin. The guest only can view the settings without the right to configure the switch; the admin can configure all the functions of the switch. The Web management pages contained in this guide are subject to the admin's login without any explanation.

Choose the menu **System**→**User Management**→**User Config** to load the following page.

User Info

User Name:

Access Level: Guest ▼

User Status: Enable Disable

Password:

Confirm Password:

Create
Clear

User Table

Select	User ID	User Name	Access Level	Status	Operation
<input type="checkbox"/>	1	admin	Admin	Enable	Edit

Delete
Help

Note:

The User Name and Password should be less than 16 characters using digits, English letters and underscores only.

Figure 4-9 User Config

The following entries are displayed on this screen:

➤ **User Info**

- User Name:** Create a name for users' login.
- Access Level:** Select the access level to login.
- Admin: Admin can edit, modify and view all the settings of different functions.
 - Guest: Guest only can view the settings without the right to edit and modify.
- User Status:** Select Enable/Disable the user configuration.
- Password:** Type a password for users' login.
- Confirm Password:** Retype the password.

➤ **User Table**

- Select:** Select the desired entry to delete the corresponding user information. It is multi-optional The current user information can't be deleted.
- User ID, Name, Access Level and status:** Displays the current user ID, user name, access level and user status.
- Operation:** Click the **Edit** button of the desired entry, and you can edit the corresponding user information. After modifying the settings, please click the **Modify** button to make the modification effective. Access level and user status of the current user information can't be modified.

4.3 System Tools

The System Tools function, allowing you to manage the configuration file of the switch, can be implemented on **Config Restore**, **Config Backup**, **Firmware Upgrade**, **System Reboot** and **System Reset** pages.

4.3.1 Config Restore

On this page you can upload a backup configuration file to restore your switch to this previous configuration.

Choose the menu **System**→**System Tools**→**Config Restore** to load the following page.

Config Restore

Restore the config from the saved config file

Select a backup config file and click the Restore Config button, and then you can restore to the previous config.

Config file:

Note:

It will take a long time to restore the config file. Please wait without any operation.

Figure 4-10 Config Restore

The following entries are displayed on this screen:

➤ **Config Restore**

Restore Config:

Click the **Restore Config** button to restore the backup configuration file. It will take effect after the switch automatically reboots.



Note:

1. It will take a few minutes to restore the configuration. Please wait without any operation.
2. To avoid any damage, please don't power down the switch while being restored.
3. After being restored, the current settings of the switch will be lost. Wrong uploaded configuration file may cause the switch unmanaged.

4.3.2 Config Backup

On this page you can download the current configuration and save it as a file to your computer for your future configuration restore.

Choose the menu **System**→**System Tools**→**Config Backup** to load the following page.

Config Backup

Backup System Config

Click the button Backup Config, you can save the config to you computer.

Backup Config

Help

Note:

It will take a long time to backup the config file. Please wait without any operation.

Figure 4-11 Config Backup

The following entries are displayed on this screen:

> Config Backup

Backup Config:

Click the **Backup Config** button to save the current configuration as a file to your computer. You are suggested to take this measure before upgrading.



Note:

It will take a few minutes to backup the configuration. Please wait without any operation.

4.3.3 Firmware Upgrade

The switch system can be upgraded via the Web management page. To upgrade the system is to get more functions and better performance. Go to <http://www.tp-link.com> to download the updated firmware.

Choose the menu **System**→**System Tools**→**Firmware Upgrade** to load the following page.

Firmware Upgrade

You will get the new function after upgrading the firmware.

Firmware File:

Browse...

Upgrade

Firmware Version: 1.0.0 Build 20120822 Rel.54711

Help

Hardware Version: TL-SL2428 1.0

Note:

1. Please select the proper software version matching with your hardware to upgrade.
2. To avoid damage, please don't turn off the device while upgrading.
3. After upgrading, the device will reboot automatically.
4. You are suggested to backup the configuration before upgrading.

Figure 4-12 Firmware Upgrade



Note:

1. Don't interrupt the upgrade.
2. Please select the proper software version matching with your hardware to upgrade.

3. To avoid damage, please don't turn off the device while upgrading.
4. After upgrading, the device will reboot automatically.
5. You are suggested to backup the configuration before upgrading.

4.3.4 System Reboot

On this page you can reboot the switch and return to the login page. Please save the current configuration before rebooting to avoid losing the configuration unsaved.

Choose the menu **System**→**System Tools**→**System Reboot** to load the following page.

System Reboot

Save Config:

Reboot:

Note:

To avoid damage, please don't turn off the device while rebooting.

Figure 4-13 System Reboot



Note:

To avoid damage, please don't turn off the device while rebooting.

4.3.5 System Reset

On this page you can reset the switch to the default. All the settings will be cleared after the switch is reset.

Choose the menu **System**→**System Tools**→**System Reset** to load the following page.

System Reset

Reset:

Note:

The System Reset option will restore the configuration to default and your current settings will be lost.

Figure 4-14 System Reset



Note:

After the system is reset, the switch will be reset to the default and all the settings will be cleared.

4.4 Access Security

Access Security is configured to control the users logging on to the Web management page.

On this page you can control the users logging on to the Web management page to enhance the configuration management security. The definitions of Admin and Guest refer to [4.2 User Management](#).

Choose the menu **System**→**Access Security**→**Access Control** to load the following page.

Access Control Config

Control Mode: ▼

IP Address: Mask:

MAC Address:

Port:

<input type="checkbox"/> 1	<input type="checkbox"/> 2	<input type="checkbox"/> 3	<input type="checkbox"/> 4	<input type="checkbox"/> 5	<input type="checkbox"/> 6	<input type="checkbox"/> 7	<input type="checkbox"/> 8
<input type="checkbox"/> 9	<input type="checkbox"/> 10	<input type="checkbox"/> 11	<input type="checkbox"/> 12	<input type="checkbox"/> 13	<input type="checkbox"/> 14	<input type="checkbox"/> 15	<input type="checkbox"/> 16
<input type="checkbox"/> 17	<input type="checkbox"/> 18	<input type="checkbox"/> 19	<input type="checkbox"/> 20	<input type="checkbox"/> 21	<input type="checkbox"/> 22	<input type="checkbox"/> 23	<input type="checkbox"/> 24
<input type="checkbox"/> 25	<input type="checkbox"/> 26	<input type="checkbox"/> 27	<input type="checkbox"/> 28				

Session Config

Session Timeout: min (5-30)

Access User Number

Number Control: Enable Disable

Admin Number: (1-16)

Guest Number: (0-15)

Figure 4-15 Access Control

The following entries are displayed on this screen:

➤ **Access Control Config**

Control Mode: Select the control mode for users to log on to the Web management page.

- IP-based: Select this option to limit the IP-range of the users for login.
- MAC-based: Select this option to limit the MAC Address of the users for login.
- Port-based: Select this option to limit the ports for login.

IP Address&Mask These fields can be available for configuration only when IP-based mode is selected. Only the users within the IP-range you set here are allowed for login.

MAC Address: The field can be available for configuration only when MAC-based mode is selected. Only the user with this MAC Address you set here is allowed for login.

Port: The field can be available for configuration only when Port-based mode is selected. Only the users connected to these ports you set here are allowed for login.

➤ **Session Config**

Session Timeout:

If you do nothing with the Web management page within the timeout time, the system will log out automatically. If you want to reconfigure, please login again.

➤ **Access User Number**

Number Control;

Select Enable/Disable the Number Control function.

Admin Number:

Enter the maximum number of the users logging on to the Web management page as Admin.

Guest Number:

Enter the maximum number of the users logging on to the Web management page as Guest.

[Return to CONTENTS](#)

Chapter 5 Switching

Switching module is used to configure the basic functions of the switch, including four submenus: **Port**, **LAG**, **Traffic Monitor** and **MAC Address**.

5.1 Port

The Port function, allowing you to configure the basic features for the port, is implemented on the **Port Config**, **Port Mirror**, **Port Security** and **Port Isolation** pages.

5.1.1 Port Config

On this page, you can configure the basic parameters for the ports. When the port is disabled, the packets on the port will be discarded. Disabling the port which is vacant for a long time can reduce the power consumption effectively. And you can enable the port when it is in need.

The parameters will affect the working mode of the port, please set the parameters appropriate to your needs.

Choose the menu **Switching**→**Port**→**Port Config** to load the following page.

Select	Port	Description	Status	Speed and Duplex	Flow Control	LAG
<input type="checkbox"/>		<input type="text"/>	Disable	10MHD	Disable	
<input type="checkbox"/>	1		Enable	Auto	Disable	---
<input type="checkbox"/>	2		Enable	Auto	Disable	---
<input type="checkbox"/>	3		Enable	Auto	Disable	---
<input type="checkbox"/>	4		Enable	Auto	Disable	---
<input type="checkbox"/>	5		Enable	Auto	Disable	---
<input type="checkbox"/>	6		Enable	Auto	Disable	---
<input type="checkbox"/>	7		Enable	Auto	Disable	---
<input type="checkbox"/>	8		Enable	Auto	Disable	---
<input type="checkbox"/>	9		Enable	Auto	Disable	---
<input type="checkbox"/>	10		Enable	Auto	Disable	---
<input type="checkbox"/>	11		Enable	Auto	Disable	---
<input type="checkbox"/>	12		Enable	Auto	Disable	---
<input type="checkbox"/>	13		Enable	Auto	Disable	---
<input type="checkbox"/>	14		Enable	Auto	Disable	---
<input type="checkbox"/>	15		Enable	Auto	Disable	---

Note:

The Port Description should be not more than 16 characters.

Figure 5-1 Port Config

Here you can view and configure the port parameters.

➤ **Port Config**

Port Select:

Click the **Select** button to quick-select the corresponding port based on the port number you entered.

Select:

Select the desired port for configuration. It is multi-optional.

Port:	Displays the port number.
Description:	Give a description to the port for identification.
Status:	Allows you to Enable/Disable the port. When Enable is selected, the port can forward the packets normally.
Speed and Duplex:	Select the Speed and Duplex mode for the port. The device connected to the switch should be in the same Speed and Duplex mode with the switch. When “Auto” is selected, the Speed and Duplex mode will be determined by auto-negotiation. For the SFP port, this Switch does not support auto-negotiation.
Flow Control:	Allows you to Enable/Disable the Flow Control feature. When Flow Control is enabled, the switch can synchronize the speed with its peer to avoid the packet loss caused by congestion.
LAG:	Displays the LAG number which the port belongs to.



Note:

1. The switch can not be managed through the disabled port. Please enable the port which is used to manage the switch.
2. The parameters of the port members in a LAG should be set as the same.
3. When using the SFP port with a 100M module or a gigabit module, you need to configure its corresponding **Speed and Duplex** mode. For 100M module, please select **100MFD** while select **1000MFD** for gigabit module. By default, the **Speed and Duplex** mode of SFP port is 1000MFD.

5.1.2 Port Mirror

Port Mirror, a packets obtaining technology, functions to forward copies of packets from one/multiple ports (mirrored port) to a specific port (mirroring port). Usually, the mirroring port is connected to a data diagnose device, which is used to analyze the mirrored packets for monitoring and troubleshooting the network.

Choose the menu **Switching**→**Port**→**Port Mirror** to load the following page.

Mirror Group List				
Group	Mirroring	Mode	Mirrored Port	Operation
1	0	Ingress	---	Edit
		Egress	---	
2	0	Ingress	---	Edit
		Egress	---	
3	0	Ingress	---	Edit
		Egress	---	
4	0	Ingress	---	Edit
		Egress	---	

Figure 5-2 Mirroring Port

The following entries are displayed on this screen.

➤ **Mirror Group List**

- Group:** Displays the mirror group number.
- Mirroring:** Displays the mirroring port number.
- Mode:** Displays the mirror mode, the value will be "Ingress" or "Egress",
- Mirrored Port:** Displays the mirrored ports.
- Operation:** Click **Edit** to configure the mirror group.

Click **Edit** to display the following figure.

Mirror Group

Number:

Mirroring Port

Mirroring Port:

Mirrored Port

Port

Select	Port	Ingress	Egress	LAG
<input type="checkbox"/>		<input type="text" value="Disable"/>	<input type="text" value="Disable"/>	
<input type="checkbox"/>	1	Disable	Disable	---
<input type="checkbox"/>	2	Disable	Disable	---
<input type="checkbox"/>	3	Disable	Disable	---
<input type="checkbox"/>	4	Disable	Disable	---
<input type="checkbox"/>	5	Disable	Disable	---
<input type="checkbox"/>	6	Disable	Disable	---
<input type="checkbox"/>	7	Disable	Disable	---
<input type="checkbox"/>	8	Disable	Disable	---
<input type="checkbox"/>	9	Disable	Disable	---
<input type="checkbox"/>	10	Disable	Disable	---
<input type="checkbox"/>	11	Disable	Disable	---
<input type="checkbox"/>	12	Disable	Disable	---

Figure 5-3 Mirroring Port

The following entries are displayed on this screen.

➤ **Mirror Group**

Number: Select the mirror group number you want to configure.

➤ **Mirroring Port**

Mirroring Port: Select the mirroring port number.

➤ **Mirrored Port**

Port Select: Click the **Select** button to quick-select the corresponding port based on the port number you entered.

Select: Select the desired port as a mirrored port. It is multi-optional.

Port: Displays the port number.

Ingress: Select Enable/Disable the Ingress feature. When the Ingress is enabled, the incoming packets received by the mirrored port will be copied to the mirroring port.

Egress: Select Enable/Disable the Egress feature. When the Egress is enabled, the outgoing packets sent by the mirrored port will be copied to the mirroring port.

LAG: Displays the LAG number which the port belongs to. The LAG member can not be selected as the mirrored port or mirroring port.



Note:

1. The LAG member can not be selected as the mirrored port or mirroring port.
2. A port can not be set as the mirrored port and the mirroring port simultaneously.
3. The Port Mirror function can take effect span the multiple VLANs.

5.1.3 Port Security

MAC Address Table maintains the mapping relationship between the port and the MAC address of the connected device, which is the base of the packet forwarding. The capacity of MAC Address Table is fixed. MAC Address Attack is the attack method that the attacker takes to obtain the network information illegally. The attacker uses tools to generate the cheating MAC address and quickly occupy the MAC Address Table. When the MAC Address Table is full, the switch will broadcast the packets to all the ports. At this moment, the attacker can obtain the network information via various sniffers and attacks. When the MAC Address Table is full, the packets traffic will flood to all the ports, which results in overload, lower speed, packets drop and even breakdown of the system.

Port Security is to protect the switch from the malicious MAC Address Attack by limiting the maximum number of MAC addresses that can be learned on the port. The port with Port Security feature enabled will learn the MAC address dynamically. When the learned MAC address number reaches the maximum, the port will stop learning. Thereafter, the other devices with the MAC address unlearned can not access to the network via this port.

Choose the menu **Switching**→**Port**→**Port Security** to load the following page.

Port Security					
Select	Port	Max Learned MAC	Learned Num	Learn Mode	Status
<input type="checkbox"/>		<input type="text" value="64"/>		Dynamic	Disable
<input type="checkbox"/>	1	64	0	Dynamic	Disable
<input type="checkbox"/>	2	64	0	Dynamic	Disable
<input type="checkbox"/>	3	64	0	Dynamic	Disable
<input type="checkbox"/>	4	64	0	Dynamic	Disable
<input type="checkbox"/>	5	64	0	Dynamic	Disable
<input type="checkbox"/>	6	64	0	Dynamic	Disable
<input type="checkbox"/>	7	64	0	Dynamic	Disable
<input type="checkbox"/>	8	64	0	Dynamic	Disable
<input type="checkbox"/>	9	64	0	Dynamic	Disable
<input type="checkbox"/>	10	64	0	Dynamic	Disable
<input type="checkbox"/>	11	64	0	Dynamic	Disable
<input type="checkbox"/>	12	64	0	Dynamic	Disable

Note:

The maximum number of MAC addresses learned from individual port can be set to 64.

Figure 5-4 Port Security

The following entries are displayed on this screen:

➤ **Port Security**

Select: Select the desired port for Port Security configuration. It is multi-optional.

Port: Displays the port number.

Max Learned MAC: Specify the maximum number of MAC addresses that can be learned on the port.

Learned Num: Displays the number of MAC addresses that have been learned on the port.

Learn Mode: Select the Learn Mode for the port.

- **Dynamic:** When Dynamic mode is selected, the learned MAC address will be deleted automatically after the aging time.
- **Static:** When Static mode is selected, the learned MAC address will be out of the influence of the aging time and can only be deleted manually. The learned entries will be cleared after the switch is rebooted.
- **Permanent:** When Permanent mode is selected, the learned MAC address will be out of the influence of the aging time and can only be deleted manually. The learned entries will be saved even the switch is rebooted.

Status: Select Enable/Disable the Port Security feature for the port.

**Note:**

The Port Security function is disabled for the LAG port member. Only the port is removed from the LAG, will the Port Security function be available for the port.

5.1.4 Port Isolation

Port Isolation provides a method of restricting traffic flow to improve the network security by forbidding the port to forward packets to the ports that are not on its forward portlist.

Choose the menu **Switching**→**Port**→**Port Isolation** to load the following page.

Port Isolation Config

Port:

Forward Portlist:

<input type="checkbox"/> 1	<input type="checkbox"/> 2	<input type="checkbox"/> 3	<input type="checkbox"/> 4	<input type="checkbox"/> 5	<input type="checkbox"/> 6
<input type="checkbox"/> 7	<input type="checkbox"/> 8	<input type="checkbox"/> 9	<input type="checkbox"/> 10	<input type="checkbox"/> 11	<input type="checkbox"/> 12
<input type="checkbox"/> 13	<input type="checkbox"/> 14	<input type="checkbox"/> 15	<input type="checkbox"/> 16	<input type="checkbox"/> 17	<input type="checkbox"/> 18
<input type="checkbox"/> 19	<input type="checkbox"/> 20	<input type="checkbox"/> 21	<input type="checkbox"/> 22	<input type="checkbox"/> 23	<input type="checkbox"/> 24
<input type="checkbox"/> 25	<input type="checkbox"/> 26	<input type="checkbox"/> 27	<input type="checkbox"/> 28		

Port Isolation List

Port	Forward Portlist
1	1-28
2	1-28
3	1-28
4	1-28
5	1-28
6	1-28
7	1-28
8	1-28
9	1-28
10	1-28
11	1-28
12	1-28
13	1-28
14	1-28
15	1-28

Figure 5-5 Port Isolation Config

The following entries are displayed on this screen:

➤ **Port Isolation Config**

Port: Select the port number to set its forwardlist.

Forward Portlist: Select the port that to be forwarded to.

➤ **Port Isolation List**

Port: Display the port number.

Forward Portlist: Display the forwardlist.

5.2 LAG

LAG (Link Aggregation Group) is to combine a number of ports together to make a single high-bandwidth data path, so as to implement the traffic load sharing among the member ports in the group and to enhance the connection reliability.

For the member ports in an aggregation group, their basic configuration must be the same. The basic configuration includes **STP, QoS, VLAN, port attributes, MAC Address Learning mode** and other associated settings. The further explains are following:

- If the ports, which are enabled for the **STP, QoS, Port Isolation** and **Port Configuration (Speed and Duplex, Flow Control)**, are in a LAG, their configurations should be the same.
- The ports, which are enabled for the **Port Security, Port Mirror, MAC Address Filtering, and Static MAC Address Binding**, can not be added to the LAG.

If the LAG is needed, you are suggested to configure the LAG function here before configuring the other functions for the member ports.



Tips:

1. Calculate the bandwidth for a LAG: If a LAG consists of the four ports in the speed of 1000Mbps Full Duplex, the whole bandwidth of the LAG is up to 8000Mbps (2000Mbps * 4) because the bandwidth of each member port is 2000Mbps counting the up-linked speed of 1000Mbps and the down-linked speed of 1000Mbps.
2. The traffic load of the LAG will be balanced among the ports according to the Aggregate Arithmetic. If the connections of one or several ports are broken, the traffic of these ports will be transmitted on the normal ports, so as to guarantee the connection reliability.

The LAG function is implemented on the **LAG Table** and **Static LAG** configuration pages.

5.2.1 LAG Table

On this page, you can view the information of the current LAG of the switch.

Choose the menu **Switching**→**LAG**→**LAG Table** to load the following page.

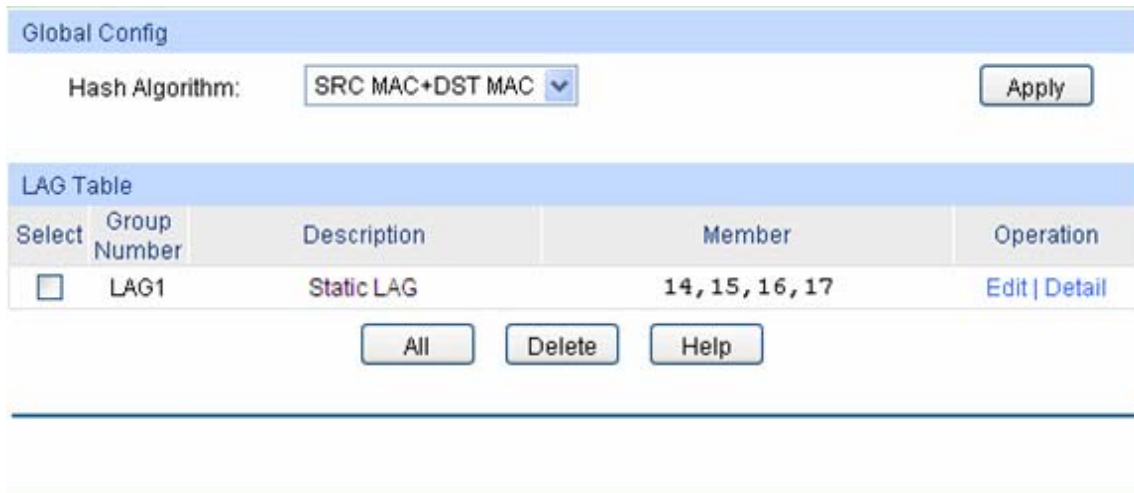

Figure 5-6 LAG Table

The following entries are displayed on this screen:

➤ **Global Config**

Hash Algorithm:

Select the applied scope of Aggregate Arithmetic, which results in choosing a port to transfer the packets.

- **SRC MAC + DST MAC:** When this option is selected, the Aggregate Arithmetic will apply to the source and destination MAC addresses of the packets.
- **SRC IP + DST IP:** When this option is selected, the Aggregate Arithmetic will apply to the source and destination IP addresses of the packets.

➤ **LAG Table**

Select:

Select the desired LAG. It is multi-optional.

Group Number:

Displays the LAG number here.

Description:

Displays the description of LAG.

Member:

Displays the LAG member.

Operation:

Allows you to view or modify the information for each LAG.

- **Edit:** Click to modify the settings of the LAG.
- **Detail:** Click to get the information of the LAG.

Click the **Detail** button for the detailed information of your selected LAG.

Detail Info	
Group Number:	LAG1
LAG Type:	Static
Port Status:	Enable
Rate:	Auto
Port mirror:	Disable
Ingress Bandwidth (bps):	--
Egress Bandwidth (bps):	--
Broadcast Control (bps):	--
Multicast Control (bps):	--
UL Control (bps):	--
QoS Priority:	CoS 0
Join VLAN:	1

Back

Figure 5-7 Detail Information

5.2.2 Static LAG

On this page, you can manually configure the LAG.

Choose the menu **Switching**→**LAG**→**Static LAG** to load the following page.

LAG Config	
Group Number:	LAG1 <input type="button" value="v"/>
Description:	<input type="text"/>

Member Port					
<input type="checkbox"/> 1	<input type="checkbox"/> 2	<input type="checkbox"/> 3	<input type="checkbox"/> 4	<input type="checkbox"/> 5	<input type="checkbox"/> 6
<input type="checkbox"/> 7	<input type="checkbox"/> 8	<input type="checkbox"/> 9	<input type="checkbox"/> 10	<input type="checkbox"/> 11	<input type="checkbox"/> 12
<input type="checkbox"/> 13	<input type="checkbox"/> 14	<input type="checkbox"/> 15	<input type="checkbox"/> 16	<input type="checkbox"/> 17	<input type="checkbox"/> 18
<input type="checkbox"/> 19	<input type="checkbox"/> 20	<input type="checkbox"/> 21	<input type="checkbox"/> 22	<input type="checkbox"/> 23	<input type="checkbox"/> 24
<input type="checkbox"/> 25	<input type="checkbox"/> 26	<input type="checkbox"/> 27	<input type="checkbox"/> 28		

Note:

1. LAG* denotes the Link Aggregation Group which the port belongs to.
2. It's not suggested to set 100M and 1000M ports in the same LAG.

Figure 5-8 Static LAG

The following entries are displayed on this screen:

➤ **LAG Config**

Group Number: Select a Group Number for the LAG.

Description: Displays the description of LAG.

➤ **Member Port**

Member Port: Select the port as the LAG member. Clearing all the ports of the LAG will delete this LAG.



Tips:

The LAG can be deleted by clearing its all member ports.

5.3 Traffic Monitor

The Traffic Monitor function, monitoring the traffic of each port, is implemented on the **Traffic Summary** and **Traffic Statistics** pages.

5.3.1 Traffic Summary

Traffic Summary screen displays the traffic information of each port, which facilitates you to monitor the traffic and analyze the network abnormality.

Choose the menu **Switching**→**Traffic Monitor**→**Traffic Summary** to load the following page.

The screenshot shows the configuration and data display for the Traffic Summary page. At the top, there is an 'Auto Refresh' section with two radio buttons: 'Enable' (unselected) and 'Disable' (selected). Below this is a 'Refresh Rate' input field with 'sec (3-300)' as a unit, and an 'Apply' button. The main area is titled 'Traffic Summary' and contains a table with columns: Port, Packets Rx, Packets Tx, Octets Rx, Octets Tx, and Statistics. A 'Port' dropdown menu is located above the table. The table lists 12 ports, with port 3 showing significant traffic. Below the table are 'Refresh', 'Clear', and 'Help' buttons.

Port	Packets Rx	Packets Tx	Octets Rx	Octets Tx	Statistics
1	0	0	0	0	Statistics
2	0	0	0	0	Statistics
3	11129	13484	1669873	4743404	Statistics
4	0	0	0	0	Statistics
5	0	0	0	0	Statistics
6	0	0	0	0	Statistics
7	0	0	0	0	Statistics
8	0	0	0	0	Statistics
9	0	0	0	0	Statistics
10	0	0	0	0	Statistics
11	0	0	0	0	Statistics
12	0	0	0	0	Statistics

Figure 5-9 Traffic Summary

The following entries are displayed on this screen:

➤ **Auto Refresh**

Auto Refresh: Allows you to Enable/Disable refreshing the Traffic Summary automatically.

Refresh Rate: Enter a value in seconds to specify the refresh interval.

➤ **Traffic Summary**

Port Select: Click the **Select** button to quick-select the corresponding port based on the port number you entered.

Port: Displays the port number.

Packets Rx: Displays the number of packets received on the port. The error packets are not counted in.

Packets Tx: Displays the number of packets transmitted on the port.

Octets Rx: Displays the number of octets received on the port. The error octets are counted in.

Octets Tx: Displays the number of octets transmitted on the port.

Statistics: Click the **Statistics** button to view the detailed traffic statistics of the port.

5.3.2 Traffic Statistics

Traffic Statistics screen displays the detailed traffic information of each port, which facilitates you to monitor the traffic and locate faults promptly.

Choose the menu **Switching**→**Traffic Monitor**→**Traffic Statistics** to load the following page.

Auto Refresh

Auto Refresh: Enable Disable

Refresh Rate: sec (3-300)

Statistics

Port

Received		Sent	
Broadcast	0	Broadcast	0
Multicast	0	Multicast	0
Unicast	0	Unicast	0
Alignment Errors	0	Collisions	0
UndersizePkts	0		
Pkts64Octets	0		
Pkts65to127Octets	0		
Pkts128to255Octets	0		
Pkts256to511Octets	0		
Pkts512to1023Octets	0		
PktsOver1023Octets	0		

Figure 5-10 Traffic Statistics

The following entries are displayed on this screen:

➤ **Auto Refresh**

- Auto Refresh:** Allows you to Enable/Disable refreshing the Traffic Summary automatically.
- Refresh Rate:** Enter a value in seconds to specify the refresh interval.

➤ **Statistics**

- Port:** Enter a port number and click **the Select** button to view the traffic statistics of the corresponding port.
- Received:** Displays the details of the packets received on the port.
- Sent:** Displays the details of the packets transmitted on the port.
- Broadcast:** Displays the number of good broadcast packets received or transmitted on the port. The error frames are not counted in.
- Multicast:** Displays the number of good multicast packets received or transmitted on the port. The error frames are not counted in.
- Unicast:** Displays the number of good unicast packets received or transmitted on the port. The error frames are not counted in.
- Alignment Errors:** Displays the number of the received packets that have a bad Frame Check Sequence (FCS) with a non-integral octet (Alignment Error). The length of the packet is between 64 bytes and 1518 bytes.
- UndersizePkts:** Displays the number of the received packets (excluding error packets) that are less than 64 bytes long.
- Pkts64Octets:** Displays the number of the received packets (including error packets) that are 64 bytes long.
- Pkts65to127Octets:** Displays the number of the received packets (including error packets) that are between 65 and 127 bytes long.
- Pkts128to255Octets:** Displays the number of the received packets (including error packets) that are between 128 and 255 bytes long.
- Pkts256to511Octets:** Displays the number of the received packets (including error packets) that are between 256 and 511 bytes long.
- Pkts512to1023Octets:** Displays the number of the received packets (including error packets) that are between 512 and 1023 bytes long.
- PktsOver1023Octets:** Displays the number of the received packets (including error packets) that are more than 1023 bytes long.
- Collisions:** Displays the number of collisions experienced by a port during packet transmissions.

5.4 MAC Address

The main function of the switch is forwarding the packets to the correct ports based on the destination MAC address of the packets. Address Table contains the port-based MAC address information, which is the base for the switch to forward packets quickly. The entries in the Address Table can be updated by auto-learning or configured manually. Most the entries are generated and updated by auto-learning. In the stable networks, the static MAC address entries can facilitate the switch to reduce broadcast packets and enhance the efficiency of packets forwarding remarkably. The address filtering feature allows the switch to filter the undesired packets and forbid its forwarding so as to improve the network security.

The types and the features of the MAC Address Table are listed as the following:

Type	Configuration Way	Aging out	Being kept after reboot (if the configuration is saved)	Relationship between the bound MAC address and the port
Static Address Table	Manually configuring	No	Yes	The bound MAC address can not be learned by the other ports in the same VLAN.
Dynamic Address Table	Automatically learning	Yes	No	The bound MAC address can be learned by the other ports in the same VLAN.
Filtering Address Table	Manually configuring	No	Yes	-

Table 5-1 Types and features of Address Table

This function includes four submenus: **Address Table**, **Static Address**, **Dynamic Address** and **Filtering Address**.

5.4.1 Address Table

On this page, you can view all the information of the Address Table.

Choose the menu **Switching**→**MAC Address**→**Address Table** to load the following page.

Search Option

MAC Address: (Format: 00-00-00-00-00-01)

VLAN ID: (1-4094)

Port:

Type: All Static Dynamic Filtering

MAC Address	VLAN ID	Port	Type	Aging Status
00-0A-EB-13-09-69	1	15	Dynamic	Aging
58-66-BA-DF-7B-05	1	15	Dynamic	Aging
6C-62-6D-F7-32-09	1	15	Dynamic	Aging
6C-62-6D-F7-32-1C	1	3	Dynamic	Aging

Total MAC Address: 4

Note:

The maximum of the displayed entries is 100 by default, please click the Search button to get the complete address entries.

Figure 5-11 Address Table

The following entries are displayed on this screen:

➤ **Search Option**

- MAC Address:** Enter the MAC address of your desired entry.
- VLAN ID:** Enter the VLAN ID of your desired entry.
- Port:** Select the corresponding port number of your desired entry.
- Type:** Select the type of your desired entry.
 - **All:** This option allows the address table to display all the address entries.
 - **Static:** This option allows the address table to display the static address entries only.
 - **Dynamic:** This option allows the address table to display the dynamic address entries only.
 - **Filtering:** This option allows the address table to display the filtering address entries only.

➤ **Address Table**

- MAC Address:** Displays the MAC address learned by the switch.
- VLAN ID:** Displays the corresponding VLAN ID of the MAC address.
- Port:** Displays the corresponding Port number of the MAC address.
- Type:** Displays the Type of the MAC address.
- Aging Status:** Displays the Aging status of the MAC address.

5.4.2 Static Address

The static address table maintains the static address entries which can be added or removed manually, independent of the aging time. In the stable networks, the static MAC address entries can facilitate the switch to reduce broadcast packets and remarkably enhance the efficiency of packets forwarding without learning the address. The static MAC address learned by the port with **Port Security** enabled in the static learning mode will be displayed in the Static Address Table.

Choose the menu **Switching**→**MAC Address**→**Static Address** to load the following page.

Create Static Address

MAC Address: (Format: 00-00-00-00-00-01)

VLAN ID: (1-4094)

Port:

Search Option

Search Option:

Static Address Table

Select	MAC Address	VLAN ID	Port	Type	Aging Status
<input type="checkbox"/>			<input type="text" value="Port 1"/> <input type="button" value="v"/>		

Total MAC Address: 0

Note:
The maximum of the displayed entries is 100 by default, please click the Search button to get the complete address entries.

Figure 5-12 Static Address

The following entries are displayed on this screen:

➤ **Create Static Address**

- MAC Address:** Enter the static MAC Address to be bound.
- VLAN ID:** Enter the corresponding VLAN ID of the MAC address.
- Port:** Select a port from the pull-down list to be bound.

➤ **Search Option**

- Search Option:** Select a Search Option from the pull-down list and click the **Search** button to find your desired entry in the Static Address Table.
 - **MAC:** Enter the MAC address of your desired entry.
 - **VLAN ID:** Enter the VLAN ID number of your desired entry.
 - **Port:** Enter the Port number of your desired entry.

➤ Static Address Table

Select:	Select the entry to delete or modify the corresponding port number. It is multi-optional.
MAC Address:	Displays the static MAC Address.
VLAN ID:	Displays the corresponding VLAN ID of the MAC address.
Port:	Displays the corresponding Port number of the MAC address. Here you can modify the port number to which the MAC address is bound. The new port should be in the same VLAN.
Type:	Displays the Type of the MAC address.
Aging Status:	Displays the Aging Status of the MAC address.



Note:

1. If the corresponding port number of the MAC address is not correct, or the connected port (or the device) has been changed, the switch can not be forward the packets correctly. Please reset the static address entry appropriately.
2. If the MAC address of a device has been added to the Static Address Table, connecting the device to another port will cause its address not to be recognized dynamically by the switch. Therefore, please ensure the entries in the Static Address Table are correct and valid.
3. The MAC address in the Static Address Table can not be added to the Filtering Address Table or bound to a port dynamically.

5.4.3 Dynamic Address

The dynamic address can be generated by the auto-learning mechanism of the switch. The Dynamic Address Table can update automatically by auto-learning or the MAC address aging out mechanism.

To fully utilize the MAC address table, which has a limited capacity, the switch adopts an aging mechanism for updating the table. That is, the switch removes the MAC address entries related to a network device if no packet is received from the device within the aging time.

On this page, you can configure the dynamic MAC address entry.

Choose the menu **Switching**→**MAC Address**→**Dynamic Address** to load the following page.

Aging Config

Auto Aging: Enable Disable

Aging Time: sec (10-630, default: 300)

Search Option

Search Option:

Dynamic Address Table

Select	MAC Address	VLAN ID	Port	Type	Aging Status
<input type="checkbox"/>	00-0A-EB-13-09-89	1	15	Dynamic	Aging
<input type="checkbox"/>	58-66-BA-DF-7B-05	1	15	Dynamic	Aging
<input type="checkbox"/>	6C-62-6D-F7-32-09	1	15	Dynamic	Aging
<input type="checkbox"/>	6C-62-6D-F7-32-1C	1	3	Dynamic	Aging

Total MAC Address: 4

Note:

The maximum of the displayed entries is 100 by default, please click the Search button to get the complete address entries.

Figure 5-13 Dynamic Address

The following entries are displayed on this screen:

➤ **Aging Config**

Auto Aging: Allows you to Enable/Disable the Auto Aging feature.

Aging Time: Enter the Aging Time for the dynamic address.

➤ **Search Option**

Search Option: Select a Search Option from the pull-down list and click the **Search** button to find your desired entry in the Dynamic Address Table.

- **MAC:** Enter the MAC address of your desired entry.
- **VLAN ID:** Enter the VLAN ID number of your desired entry.
- **Port:** Enter the Port number of your desired entry.

➤ **Dynamic Address Table**

Select: Select the entry to delete the dynamic address or to bind the MAC address to the corresponding port statically. It is multi-optional.

MAC Address: Displays the dynamic MAC Address.

VLAN ID: Displays the corresponding VLAN ID of the MAC address.

Port: Displays the corresponding port number of the MAC address.

- Type:** Displays the Type of the MAC address.
- Aging Status:** Displays the Aging Status of the MAC address.
- Bind:** Click the **Bind** button to bind the MAC address of your selected entry to the corresponding port statically.



Tips:

Setting aging time properly helps implement effective MAC address aging. The aging time that is too long or too short results decreases the performance of the switch. If the aging time is too long, excessive invalid MAC address entries maintained by the switch may fill up the MAC address table. This prevents the MAC address table from updating with network changes in time. If the aging time is too short, the switch may remove valid MAC address entries. This decreases the forwarding performance of the switch. It is recommended to keep the default value.

5.4.4 Filtering Address

The filtering address is to forbid the undesired packets to be forwarded. The filtering address can be added or removed manually, independent of the aging time. The filtering MAC address allows the switch to filter the packets which includes this MAC address as the source address or destination address, so as to guarantee the network security. The filtering MAC address entries act on all the ports in the corresponding VLAN.

Choose the menu **Switching**→**MAC Address**→**Filtering Address** to load the following page.

Create Filtering Address

MAC Address: (Format: 00-00-00-00-00-01)

VLAN ID: (1-4094)

Search Option

Search Option:

Filtering Address Table

Select	MAC Address	VLAN ID	Port	Type	Aging Status
<input type="button" value="All"/> <input type="button" value="Delete"/> <input type="button" value="Help"/>					

Total MAC Address: 0

Note:

The maximum of the displayed entries is 100 by default, please click the Search button to get the complete address entries.

Figure 5-14 Filtering Address

The following entries are displayed on this screen:

➤ **Create Filtering Address**

MAC Address: Enter the MAC Address to be filtered.

VLAN ID: Enter the corresponding VLAN ID of the MAC address.

➤ **Search Option**

Search Option: Select a Search Option from the pull-down list and click the **Search** button to find your desired entry in the Filtering Address Table.

- **MAC:** Enter the MAC address of your desired entry.
- **VLAN ID:** Enter the VLAN ID number of your desired entry.

➤ **Filtering Address Table**

Select: Select the entry to delete the corresponding filtering address. It is multi-optional.

MAC Address: Displays the filtering MAC Address.

VLAN ID: Displays the corresponding VLAN ID.

Port: Here the symbol “__” indicates no specified port.

Type: Displays the Type of the MAC address.

Aging Status: Displays the Aging Status of the MAC address.



Note:

The MAC address in the Filtering Address Table can not be added to the Static Address Table or bound to a port dynamically.

[Return to CONTENTS](#)

Chapter 6 VLAN

The traditional Ethernet is a data network communication technology basing on CSMA/CD (Carrier Sense Multiple Access/Collision Detect) via shared communication medium. Through the traditional Ethernet, the overfull hosts in LAN will result in serious collision, flooding broadcasts, poor performance or even breakdown of the Internet. Though connecting the LANs through switches can avoid the serious collision, the flooding broadcasts can not be prevented, which will occupy plenty of bandwidth resources, causing potential serious security problems.

A Virtual Local Area Network (VLAN) is a network topology configured according to a logical scheme rather than the physical layout. The VLAN technology is developed for switches to control broadcast in LANs. By creating VLANs in a physical LAN, you can divide the LAN into multiple logical LANs, each of which has a broadcast domain of its own. Hosts in the same VLAN communicate with one another as if they are in a LAN. However, hosts in different VLANs cannot communicate with one another directly. Therefore, broadcast packets are limited in a VLAN. Hosts in the same VLAN communicate with one another via Ethernet whereas hosts in different VLANs communicate with one another through the Internet devices such as Router, the Lay3 Switch, etc. The following figure illustrates a VLAN implementation.

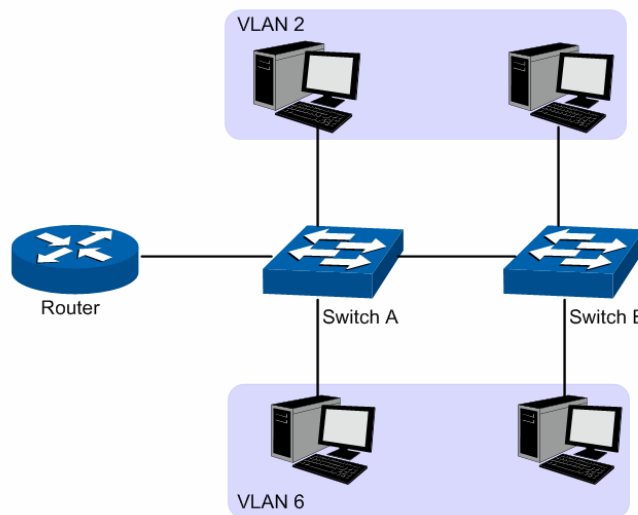

Figure 6-1 VLAN implementation

Compared with the traditional Ethernet, VLAN enjoys the following advantages.

- (1) Broadcasts are confined to VLANs. This decreases bandwidth utilization and improves network performance.
- (2) Network security is improved. VLANs cannot communicate with one another directly. That is, a host in a VLAN cannot access resources in another VLAN directly, unless routers or Layer 3 switches are used.
- (3) Network configuration workload for the host is reduced. VLAN can be used to group specific hosts. When the physical position of a host changes within the range of the VLAN, you need not change its network configuration.

A VLAN can span across multiple switches, or even routers. This enables hosts in a VLAN to be dispersed in a looser way. That is, hosts in a VLAN can belong to different physical network segment. This switch supports 802.1Q VLAN to classify VLANs. VLAN tags in the packets are necessary for the switch to identify packets of different VLANs. The switch can analyze the received untagged packets on the port and match the packets with the 802.1Q VLAN. If a packet is

matched, the switch will add a corresponding VLAN tag to it and forward it in the corresponding VLAN.

6.1 802.1Q VLAN

VLAN tags in the packets are necessary for the switch to identify packets of different VLANs. The switch works at the data link layer in OSI model and it can identify the data link layer encapsulation of the packet only, so you can add the VLAN tag field into the data link layer encapsulation for identification.

In 1999, IEEE issues the IEEE 802.1Q protocol to standardize VLAN implementation, defining the structure of VLAN-tagged packets. IEEE 802.1Q protocol defines that a 4-byte VLAN tag is encapsulated after the destination MAC address and source MAC address to show the information about VLAN.

As shown in the following figure, a VLAN tag contains four fields, including TPID (Tag Protocol Identifier), Priority, CFI (Canonical Format Indicator), and VLAN ID.

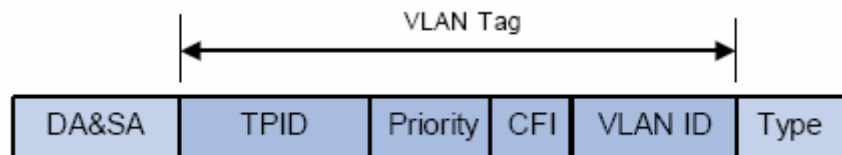

Figure 6-2 Format of VLAN Tag

- (1) TPID: TPID is a 16-bit field, indicating that this data frame is VLAN-tagged. By default, it is 0x8100.
- (2) Priority: Priority is a 3-bit field, referring to 802.1p priority. Refer to section “QoS & QoS profile” for details.
- (3) CFI: CFI is a 1-bit field, indicating whether the MAC address is encapsulated in the standard format in different transmission media. This field is not described in detail in this chapter.
- (4) VLAN ID: VLAN ID is a 12-bit field, indicating the ID of the VLAN to which this packet belongs. It is in the range of 0 to 4,095. Generally, 0 and 4,095 is not used, so the field is in the range of 1 to 4,094.

VLAN ID identifies the VLAN to which a packet belongs. When the switch receives an un-VLAN-tagged packet, it will encapsulate a VLAN tag with the default VLAN ID of the inbound port for the packet, and the packet will be assigned to the default VLAN of the inbound port for transmission.

In this User Guide, the tagged packet refers to the packet with VLAN tag whereas the untagged packet refers to the packet without VLAN tag, and the priority-tagged packet refers to the packet with VLAN tag whose VLAN ID is 0.

➤ Link Types of ports

When creating the 802.1Q VLAN, you should set the link type for the port according to its connected device. The link types of port including the following three types:

- (1) **ACCESS:** The ACCESS port can be added in a single VLAN, and the egress rule of the port is UNTAG. The PVID is same as the current VLAN ID. If the ACCESS port is added to another VLAN, it will be removed from the current VLAN automatically.

- (2) **TRUNK:** The TRUNK port can be added in multiple VLANs, and the egress rule of the port is TAG. The TRUNK port is generally used to connect the cascaded network devices for it can receive and forward the packets of multiple VLANs. When the packets are forwarded by the TRUNK port, its VLAN tag will not be changed.
- (3) **GENERAL:** The GENERAL port can be added in multiple VLANs and set various egress rules according to the different VLANs. The default egress rule is UNTAG. The PVID can be set as the VID number of any VLAN the port belongs to.

➤ **PVID**

PVID (Port Vlan ID) is the default VID of the port. When the switch receives an un-VLAN-tagged packet, it will add a VLAN tag to the packet according to the PVID of its received port and forward the packets.

When creating VLANs, the PVID of each port, indicating the default VLAN to which the port belongs, is an important parameter with the following two purposes:

- (1) When the switch receives an un-VLAN-tagged packet, it will add a VLAN tag to the packet according to the PVID of its received port
- (2) PVID determines the default broadcast domain of the port, i.e. when the port receives UL packets or broadcast packets, the port will broadcast the packets in its default VLAN.

Different packets, tagged or untagged, will be processed in different ways, after being received by ports of different link types, which is illustrated in the following table.

Port Type	Receiving Packets		Forwarding Packets
	Untagged Packets	Tagged Packets	
Access	When untagged packets are received, the port will add the default VLAN tag, i.e. the PVID of the ingress port, to the packets.	If the VID of packet is the same as the PVID of the port, the packet will be received. If the VID of packet is not the same as the PVID of the port, the packet will be dropped.	The packet will be forwarded after removing its VLAN tag.
Trunk		If the VID of packet is allowed by the port, the packet will be received. If the VID of packet is forbidden by the port, the packet will be dropped.	The packet will be forwarded with its current VLAN tag.
General			If the egress rule of port is TAG, the packet will be forwarded with its current VLAN tag. If the egress rule of port is UNTAG, the packet will be forwarded after removing its VLAN tag.

Table 6-1 Relationship between Port Types and VLAN Packets Processing

IEEE 802.1Q VLAN function is implemented on the **VLAN Config** and **Port Config** pages.

6.1.1 VLAN Config

On this page, you can view the current created 802.1Q VLAN.

Choose the menu **VLAN**→**802.1Q VLAN**→**VLAN Config** to load the following page.

VLAN Table				
			VLAN ID <input type="text"/>	<input type="button" value="Select"/>
Select	VLAN ID	Name	Members	Operation
<input type="checkbox"/>	1	Default VLAN	1-28	Edit Detail

Total VLAN: 1

Figure 6-3 VLAN Table

To ensure the normal communication of the factory switch, the default VLAN of all ports is set to VLAN1. VLAN1 can not be modified or deleted.

The following entries are displayed on this screen:

➤ **VLAN Table**

- VLAN ID Select:** Click the **Select** button to quick-select the corresponding entry based on the VLAN ID number you entered.
- Select:** Select the desired entry to delete the corresponding VLAN. It is multi-optional.
- VLAN ID:** Displays the ID number of VLAN.
- Description:** Displays the user-defined description of VLAN.
- Members:** Displays the port members in the VLAN.
- Operation:** Allows you to view or modify the information for each entry.
- Edit: Click to modify the settings of VLAN.
 - Detail: Click to get the information of VLAN.

Click **Edit** button to modify the settings of the corresponding VLAN. Click **Create** button to create a new VLAN.

VLAN Info.

VLAN ID: (2-4094)

Name: (16 characters maximum)

VLAN Members

Port

Select	Port	Link Type	Egress Rule	LAG
<input checked="" type="checkbox"/>	1	ACCESS	UNTAG	---
<input checked="" type="checkbox"/>	2	ACCESS	UNTAG	---
<input checked="" type="checkbox"/>	3	ACCESS	UNTAG	---
<input checked="" type="checkbox"/>	4	ACCESS	UNTAG	---
<input checked="" type="checkbox"/>	5	ACCESS	UNTAG	---
<input checked="" type="checkbox"/>	6	ACCESS	UNTAG	---
<input checked="" type="checkbox"/>	7	ACCESS	UNTAG	---
<input checked="" type="checkbox"/>	8	ACCESS	UNTAG	---
<input checked="" type="checkbox"/>	9	ACCESS	UNTAG	---
<input checked="" type="checkbox"/>	10	ACCESS	UNTAG	---
<input checked="" type="checkbox"/>	11	ACCESS	UNTAG	---
<input checked="" type="checkbox"/>	12	ACCESS	UNTAG	---
<input checked="" type="checkbox"/>	13	ACCESS	UNTAG	---
<input checked="" type="checkbox"/>	14	ACCESS	UNTAG	---

note:

1.Link Type can be changed in Page "Port Config".

Figure 6-4 Create or Modify 802.1Q VLAN

The following entries are displayed on this screen:

➤ **VLAN Config**

VLAN ID: Enter the ID number of VLAN.

Description: Give a description to the VLAN for identification.

➤ **VLAN Members**

Port Select: Click the **Select** button to quick-select the corresponding entry based on the port number you entered.

Select: Select the desired port to be a member of VLAN or leave it blank. It's multi-optional.

Port: Displays the port number.

Link Type: Displays the Link Type of the port. It can be reset on Port Config screen.

Egress Rule: Select the Egress Rule for the VLAN port member. The default egress rule is UNTAG.

- TAG: All packets forwarded by the port are tagged. The packets contain VLAN information.
- UNTAG: Packets forwarded by the port are untagged.

LAG: Displays the LAG to which the port belongs.

6.1.2 Port Config

Before creating the 802.1Q VLAN, please acquaint yourself with all the devices connected to the switch in order to configure the ports properly.

Choose the menu **VLAN**→**802.1Q VLAN**→**Port Config** to load the following page.

Select	Port	Link Type	PVID	LAG	VLAN
<input type="checkbox"/>		ACCESS			
<input type="checkbox"/>	1	ACCESS	1	---	Detail
<input type="checkbox"/>	2	ACCESS	1	---	Detail
<input type="checkbox"/>	3	ACCESS	1	---	Detail
<input type="checkbox"/>	4	ACCESS	1	---	Detail
<input type="checkbox"/>	5	ACCESS	1	---	Detail
<input type="checkbox"/>	6	ACCESS	1	---	Detail
<input type="checkbox"/>	7	ACCESS	1	---	Detail
<input type="checkbox"/>	8	ACCESS	1	---	Detail
<input type="checkbox"/>	9	ACCESS	1	---	Detail
<input type="checkbox"/>	10	ACCESS	1	---	Detail
<input type="checkbox"/>	11	ACCESS	1	---	Detail
<input type="checkbox"/>	12	ACCESS	1	---	Detail
<input type="checkbox"/>	13	ACCESS	1	---	Detail
<input type="checkbox"/>	14	ACCESS	1	---	Detail

Figure 6-5 802.1Q VLAN – Port Config

The following entries are displayed on this screen:

➤ **VLAN Port Config**

Port Select: Click the **Select** button to quick-select the corresponding entry based on the port number you entered.

Select: Select the desired port for configuration. It is multi-optional.

Port: Displays the port number.

Link Type:

Select the Link Type from the pull-down list for the port.

- **ACCESS:** The ACCESS port can be added in a single VLAN, and the egress rule of the port is UNTAG. The PVID is same as the current VLAN ID. If the current VLAN is deleted, the PVID will be set to 1 by default.
- **TRUNK:** The TRUNK port can be added in multiple VLANs, and the egress rule of the port is TAG. The PVID can be set as the VID number of any VLAN the port belongs to.
- **GENERAL:** The GENERAL port can be added in multiple VLANs and set various egress rules according to the different VLANs. The default egress rule is UNTAG. The PVID can be set as the VID number of any VLAN the port belongs to.

PVID:

Enter the PVID number of the port.

LAG:

Displays the LAG to which the port belongs.

VLAN:

Click the **Detail** button to view the information of the VLAN to which the port belongs.

Click the **Detail** button to view the information of the corresponding VLAN

VLAN of Port 13		
		VLAN ID <input type="text"/> <input type="button" value="Select"/>
VLAN ID	VLAN Name	Operation
1	Default VLAN	Remove

Note:

Total VLAN of Port 13: 1

Figure 6-6 View the Current VLAN of Port

The following entries are displayed on this screen:

➤ **VLAN of Port**

VLAN ID Select:

Click the **Select** button to quick-select the corresponding entry based on the VLAN ID number you entered.

VLAN ID:

Displays the ID number of VLAN.

VLAN Description:

Displays the user-defined description of VLAN.

Operation:

Allows you to remove the port from the current VLAN.

Configuration procedure:

Step	Operation	Description
1	Set the link type for port.	Required. On the VLAN→802.1Q VLAN→Port Config page, set the link type for the port basing on its connected device.
2	Create VLAN.	Required. On the VLAN→802.1Q VLAN→VLAN Config page, click the Create button to create a VLAN. Enter the VLAN ID and the description for the VLAN. Meanwhile, specify its member ports.
3	Modify/View VLAN.	Optional. On the VLAN→802.1Q VLAN→VLAN Config page, click the Edit/Detail button to modify/view the information of the corresponding VLAN.
4	Delete VLAN	Optional. On the VLAN→802.1Q VLAN→VLAN Config page, select the desired entry to delete the corresponding VLAN by clicking the Delete button.

6.2 Application Example for 802.1Q VLAN

➤ Network Requirements

- Switch A is connecting to PC A and Server B;
- Switch B is connecting to PC B and Server A;
- PC A and Server A is in the same VLAN;
- PC B and Server B is in the same VLAN;
- PCs in the two VLANs cannot communicate with each other.

➤ Network Diagram

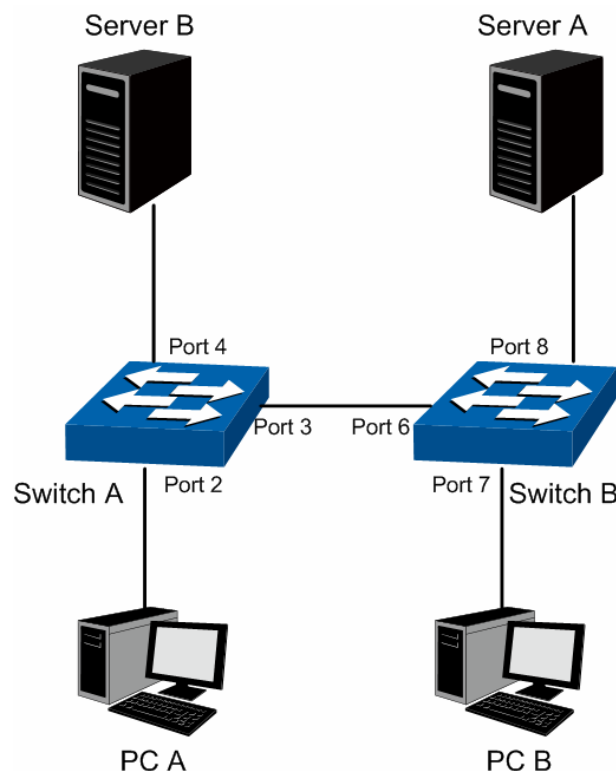

➤ **Configuration Procedure**

- Configure Switch A

Step	Operation	Description
1	Configure the Link Type of the ports	Required. On VLAN→802.1Q VLAN→Port Config page, configure the link type of Port 2, Port 3 and Port 4 as ACCESS, TRUNK and ACCESS respectively
2	Create VLAN10	Required. On VLAN→802.1Q VLAN→VLAN Config page, create a VLAN with its VLANID as 10, owning Port 2 and Port 3.
3	Create VLAN20	Required. On VLAN→802.1Q VLAN→VLAN Config page, create a VLAN with its VLANID as 20, owning Port 3 and Port 4.

- Configure Switch B

Step	Operation	Description
1	Configure the Link Type of the ports	Required. On VLAN→802.1Q VLAN→Port Config page, configure the link type of Port 7, Port 6 and Port 8 as ACCESS, TRUNK and ACCESS respectively.
2	Create VLAN10	Required. On VLAN→802.1Q VLAN→VLAN Config page, create a VLAN with its VLANID as 10, owning Port 6 and Port 8.
3	Create VLAN20	Required. On VLAN→802.1Q VLAN→VLAN Config page, create a VLAN with its VLANID as 20, owning Port 6 and Port 7.

[Return to CONTENTS](#)

Chapter 7 Spanning Tree

STP (Spanning Tree Protocol), subject to IEEE 802.1D standard, is to disbranch a ring network in the Data Link layer in a local network. Devices running STP discover loops in the network and block ports by exchanging information, in that way, a ring network can be disbranched to form a tree-topological ring-free network to prevent packets from being duplicated and forwarded endlessly in the network.

BPDU (Bridge Protocol Data Unit) is the protocol data that STP and RSTP use. Enough information is carried in BPDU to ensure the spanning tree generation. STP is to determine the topology of the network via transferring BPDUs between devices.

To implement spanning tree function, the switches in the network transfer BPDUs between each other to exchange information and all the switches supporting STP receive and process the received BPDUs. BPDUs carry the information that is needed for switches to figure out the spanning tree.

> STP Elements

Bridge ID (Bridge Identifier) : Indicates the value of the priority and MAC address of the bridge. Bridge ID can be configured and the switch with the lower bridge ID has the higher priority.

Root Bridge: Indicates the switch has the lowest bridge ID. Configure the best PC in the ring network as the root bridge to ensure best network performance and reliability.

Designated Bridge: Indicates the switch has the lowest path cost from the switch to the root bridge in each network segment. BPDUs are forwarded to the network segment through the designated bridge. The switch with the lowest bridge ID will be chosen as the designated bridge.

Root Path Cost: Indicates the sum of the path cost of the root port and the path cost of all the switches that packets pass through. The root path cost of the root bridge is 0.

Bridge Priority: The bridge priority can be set to a value in the range of 0~61440. The lower value priority has the higher priority. The switch with the higher priority has more chance to be chosen as the root bridge.

Root Port: Indicates the port that has the lowest path cost from this bridge to the Root Bridge and forwards packets to the root.

Designated Port: Indicates the port that forwards packets to a downstream network segment or switch.

Port Priority: The port priority can be set to a value in the range of 0~255. The lower value priority has the higher priority. The port with the higher priority has more chance to be chosen as the root port.

Path Cost: Indicates the parameter for choosing the link path by STP. By calculating the path cost, STP chooses the better links and blocks the redundant links so as to disbranch the ring-network to form a tree-topological ring-free network.

The following network diagram shows the sketch map of spanning tree. Switch A, B and C are connected together in order. After STP generation, switch A is chosen as root bridge, the path from port 2 to port 6 is blocked.

- Bridge: Switch A is the root bridge in the whole network; switch B is the designated bridge of switch C.

- Port: Port 3 is the root port of switch B and port 5 is the root port of switch C; port 1 is the designated port of switch A and port 4 is the designated port of switch B; port 6 is the blocked port of switch C.

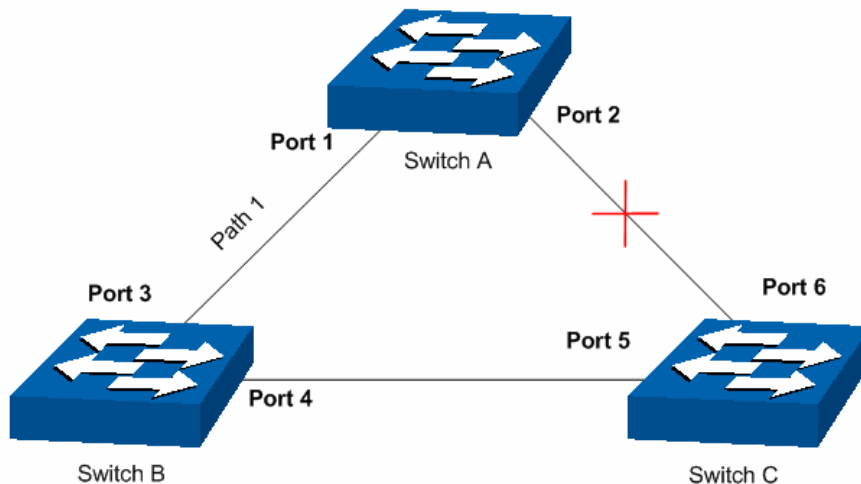

Figure 7-1 Basic STP diagram

➤ STP Timers

Hello Time:

Hello Time ranges from 1 to 10 seconds. It specifies the interval to send BPDU packets. It is used to test the links.

Max. Age:

Max. Age ranges from 6 to 40 seconds. It specifies the maximum time the switch can wait without receiving a BPDU before attempting to reconfigure.

Forward Delay:

Forward Delay ranges from 4 to 30 seconds. It specifies the time for the port to transit its state after the network topology is changed.

When the STP regeneration caused by network malfunction occurs, the STP structure will get some corresponding change. However, as the new configuration BPDUs cannot be spread in the whole network at once, the temporal loop will occur if the port transits its state immediately. Therefore, STP adopts a state transit mechanism, that is, the new root port and the designated port begins to forward data after twice forward delay, which ensures the new configuration BPDUs are spread in the whole network.

➤ BPDU Comparing Principle in STP mode

Assuming two BPDUs: BPDU X and BPDU Y

If the root bridge ID of X is smaller than that of Y, X is superior to Y.

If the root bridge ID of X equals that of Y, but the root path cost of X is smaller than that of Y, X is superior to Y.

If the root bridge ID and the root path cost of X equal those of Y, but the bridge ID of X is smaller than that of Y, X is superior to Y.

If the root bridge ID, the root path cost and bridge ID of X equal those of Y, but the port ID of X is smaller than that of Y, X is superior to Y.

➤ **STP Generation**

- In the beginning

In the beginning, each switch regards itself as the root, and generates a configuration BPDU for each port on it as a root, with the root path cost being 0, the ID of the designated bridge being that of the switch, and the designated port being itself.

- Comparing BPDUs

Each switch sends out configuration BPDUs and receives a configuration BPDU on one of its ports from another switch. The following table shows the comparing operations.

Step	Operation
1	If the priority of the BPDU received on the port is lower than that of the BPDU if of the port itself, the switch discards the BPDU and does not change the BPDU of the port.
2	If the priority of the BPDU is higher than that of the BPDU of the port itself, the switch replaces the BPDU of the port with the received one and compares it with those of other ports on the switch to obtain the one with the highest priority.

Table 7-1 Comparing BPDUs

- Selecting the root bridge

The root bridge is selected by BPDU comparing. The switch with the smallest root ID is chosen as the root bridge.

- Selecting the root port and designate port

The operation is taken in the following way:

Step	Operation
1	For each switch (except the one chosen as the root bridge) in a network, the port that receives the BPDU with the highest priority is chosen as the root port of the switch.
2	Using the root port BPDU and the root path cost, the switch generates a designated port BPDU for each of its ports. <ul style="list-style-type: none"> ● Root ID is replaced with that of the root port; ● Root path is replaced with the sum of the root path cost of the root port and the path cost between this port and the root port; ● The ID of the designated bridge is replaced with that of the switch; ● The ID of the designated port is replaced with that of the port.
3	The switch compares the resulting BPDU with the BPDU of the desired port whose role you want to determine. <ul style="list-style-type: none"> ● If the resulting BPDU takes the precedence over the BPDU of the port, the port is chosen as the designated port and the BPDU of this port is replaced with the resulting BPDU. The port regularly sends out the resulting BPDU; ● If the BPDU of this port takes the precedence over the resulting BPDU, the BPDU of this port is not replaced and the port is blocked. The port only can receive BPDUs.

Table 7-2 Selecting root port and designated port



Tips:

In a STP with stable topology, only the root port and designated port can forward data, and the other ports are blocked. The blocked ports only can receive BPDUs.

RSTP (Rapid Spanning Tree Protocol), evolved from the 802.1D STP standard, enable Ethernet ports to transit their states rapidly. The premises for the port in the RSTP to transit its state rapidly are as follows.

- The condition for the root port to transit its port state rapidly: The old root port of the switch stops forwarding data and the designated port of the upstream switch begins to forward data.
- The condition for the designated port to transit its port state rapidly: The designated port is an edge port or connecting to a point-to-point link. If the designated port is an edge port, it can directly transit to forwarding state; if the designated port is connecting to a point-to-point link, it can transit to forwarding state after getting response from the downstream switch through handshake.

➤ RSTP Elements

Edge Port: Indicates the port connected directly to terminals.

P2P Link: Indicates the link between two switches directly connected.

MSTP (Multiple Spanning Tree Protocol), compatible with both STP and RSTP and subject to IEEE 802.1s standard, not only enables spanning trees to converge rapidly, but also enables packets of different VLANs to be forwarded along their respective paths so as to provide redundant links with a better load-balancing mechanism.

Features of MSTP:

- MSTP combines VLANs and spanning tree together via VLAN-to-instance mapping table. It binds several VLANs to an instance to save communication cost and network resources.
- MSTP divides a spanning tree network into several regions. Each region has several internal spanning trees, which are independent of each other.
- MSTP provides a load-balancing mechanism for the packets transmission in the VLAN.
- MSTP is compatible with both STP and RSTP.

➤ MSTP Elements

MST Region (Multiple Spanning Tree Region): An MST Region comprises switches with the same region configuration and VLAN-to-Instances mapping relationship.

IST (Internal Spanning Tree): An IST is a spanning tree in an MST.

CST (Common Spanning Tree): A CST is the spanning tree in a switched network that connects all MST regions in the network.

CIST (Common and Internal Spanning Tree): A CIST, comprising IST and CST, is the spanning tree in a switched network that connects all switches in the network.

The following figure shows the network diagram in MSTP.

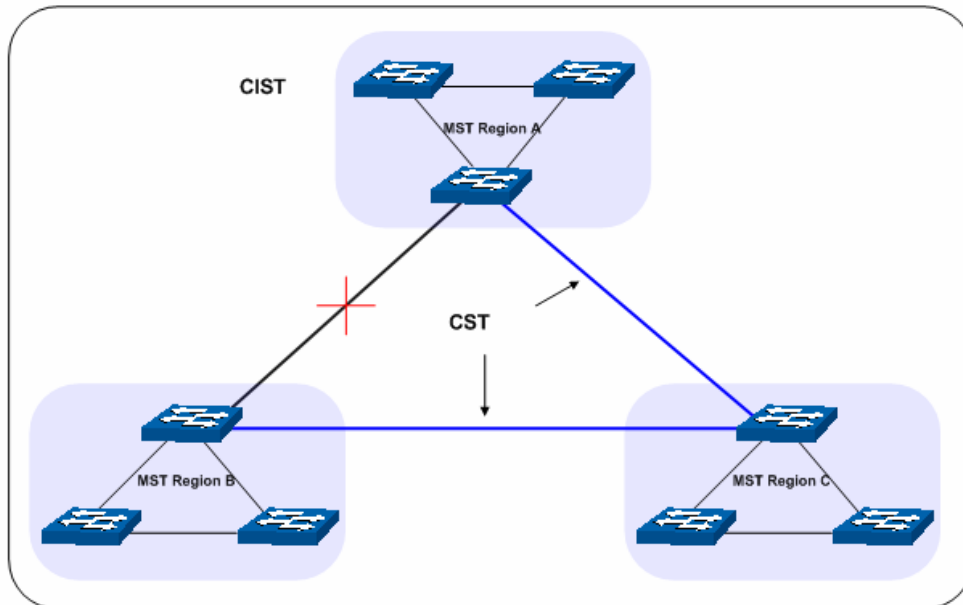

Figure 7-2 Basic MSTP diagram

➤ **MSTP**

MSTP divides a network into several MST regions. The CST is generated between these MST regions, and multiple spanning trees can be generated in each MST region. Each spanning tree is called an instance. As well as STP, MSTP uses BPDUs to generate spanning tree. The only difference is that the BPDUs for MSTP carry the MSTP configuration information on the switches.

➤ **Port States**

In an MSTP, ports can be in the following four states:

- Forwarding: In this status the port can receive/forward data, receive/send BPDUs as well as learn MAC address.
- Learning: In this status the port can receive/send BPDUs and learn MAC address.
- Blocking: In this status the port can only receive BPDUs.
- Disconnected: In this status the port is not participating in the STP.

➤ **Port Roles**

In an MSTP, the following roles exist:

- Root Port: Indicates the port that has the lowest path cost from this bridge to the Root Bridge and forwards packets to the root.
- Designated Port: Indicates the port that forwards packets to a downstream network segment or switch.
- Master Port: Indicates the port that connects a MST region to the common root. The path from the master port to the common root is the shortest path between this MST region and the common root.
- Alternate Port: Indicates the port that can be a backup port of a root or master port.
- Backup Port: Indicates the port that is the backup port of a designated port.
- Disabled: Indicates the port that is not participating in the STP.

The following diagram shows the different port roles.

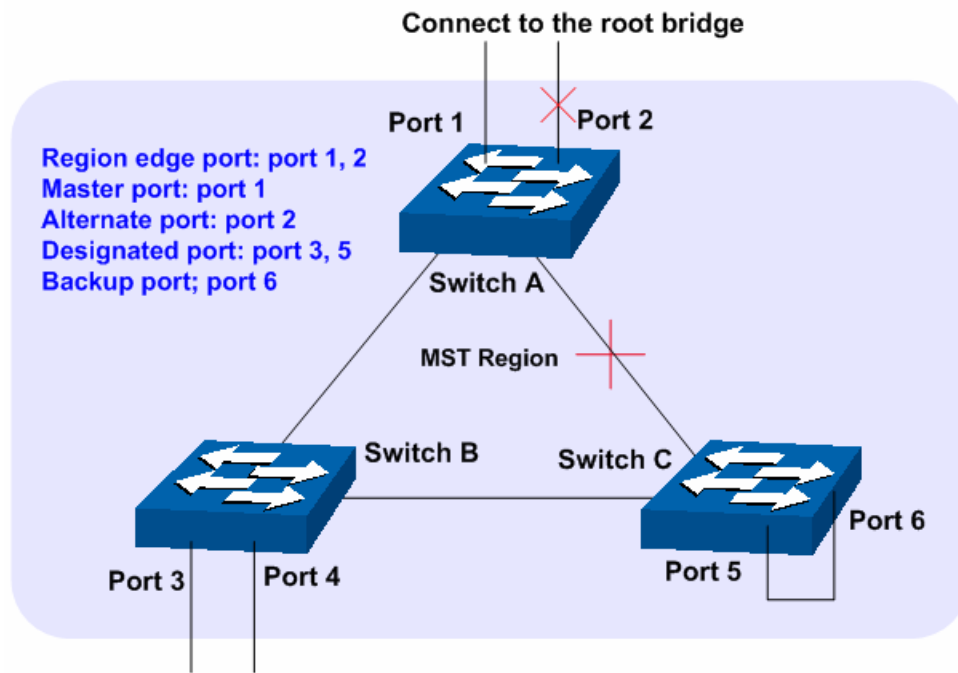

Figure 7-3 Port roles

The Spanning Tree module is mainly for spanning tree configuration of the switch, including four submenus: **STP Config**, **Port Config**, **MSTP Instance** and **STP Security**.

7.1 STP Config

The STP Config function, for global configuration of spanning trees on the switch, can be implemented on **STP Config** and **STP Summary** pages.

7.1.1 STP Config

Before configuring spanning trees, you should make clear the roles each switch plays in each spanning tree instance. Only one switch can be the root bridge in each spanning tree instance. On this page you can globally configure the spanning tree function and related parameters.

Choose the menu **Spanning Tree**→**STP Config**→**STP Config** to load the following page.

Global Config

STP: Enable Disable Apply

Version: Apply

Parameters Config

CIST Priority: (0-61440)

Hello Time: sec (1-10)

Max Age: sec (6-40) Apply

Forward Delay: sec (4-30) Help

TxHoldCount: pps (1-20)

Max Hops: hop (1-40)

Figure 7-4 STP Config

The following entries are displayed on this screen:

➤ **Global Config**

STP: Select Enable/Disable STP function globally on the switch.

Version: Select the desired STP version on the switch.

- STP: Spanning Tree Protocol.
- RSTP: Rapid Spanning Tree Protocol.
- MSTP: Multiple Spanning Tree Protocol.

➤ **Parameters Config**

CIST Priority: Enter a value from 0 to 61440 to specify the priority of the switch for comparison in the CIST. CIST priority is an important criterion on determining the root bridge. In the same condition, the switch with the highest priority will be chosen as the root bridge. The lower value has the higher priority. The default value is 32768 and should be exact divisor of 4096.

Hello Time Enter a value from 1 to 10 in seconds to specify the interval to send BPDU packets. It is used to test the links. $2 * (\text{Hello Time} + 1) \leq \text{Max Age}$. The default value is 2 seconds.

Max Age: Enter a value from 6 to 40 in seconds to specify the maximum time the switch can wait without receiving a BPDU before attempting to reconfigure. The default value is 20 seconds.

Forward Delay: Enter a value from 4 to 30 in seconds to specify the time for the port to transit its state after the network topology is changed. $2 * (\text{Forward Delay} - 1) \geq \text{Max Age}$. The default value is 15 seconds.

TxHoldCount: Enter a value from 1 to 20 to set the maximum number of BPDU packets transmitted per Hello Time interval. The default value is

5pps.

Max Hops:

Enter a value from 1 to 40 to set the maximum number of hops that occur in a specific region before the BPDU is discarded. The default value is 20 hops.



Note:

1. The forward delay parameter and the network diameter are correlated. A too small forward delay parameter may result in temporary loops. A too large forward delay may cause a network unable to resume the normal state in time. The default value is recommended.
2. An adequate hello time parameter can enable the switch to discover the link failures occurred in the network without occupying too much network resources. A too large hello time parameter may result in normal links being regarded as invalid when packets drop occurred in the links, which in turn result in spanning tree being regenerated. A too small hello time parameter may result in duplicated configuration being sent frequently, which increases the network load of the switches and wastes network resources. The default value is recommended.
3. A too small max age parameter may result in the switches regenerating spanning trees frequently and cause network congestions to be falsely regarded as link problems. A too large max age parameter result in the switches unable to find the link problems in time, which in turn handicaps spanning trees being regenerated in time and makes the network less adaptive. The default value is recommended.
4. If the TxHold Count parameter is too large, the number of MSTP packets being sent in each hello time may be increased with occupying too much network resources. The default value is recommended.

7.1.2 STP Summary

On this page you can view the related parameters for Spanning Tree function.

Choose the menu **Spanning Tree**→**STP Config**→**STP Summary** to load the following page.

STP Summary	
STP Status:	Disable
STP Version:	---
Local Bridge:	---
Root Bridge:	---
External Path Cost:	---
Region Root:	---
Internal Path Cost:	---
Designated Bridge:	---
Root Port:	---
Latest TC Time:	---
TC Count:	0

MSTP Instance Summary	
Instance ID	1 ▾
Instance Status:	Disable
Local Bridge:	---
Region Root:	---
Internal Path Cost:	---
Designated Bridge:	---
Root Port:	---
Latest TC Time:	---
TC Count:	---

Figure 7-5 STP Summary

7.2 Port Config

On this page you can configure the parameters of the ports for CIST

Choose the menu **Spanning Tree**→**Port Config** to load the following page.

Port Config

Port

Select	Port	Status	Priority	ExtPath Cost	IntPath Cost	Edge Port	P2P Link	MCheck	STP Version	Port Role	Port Status	LAG
<input type="checkbox"/>		Disable	<input type="text"/>	<input type="text"/>	<input type="text"/>	Disable	Auto	Unchange				
<input type="checkbox"/>	1	Disable	128	Auto	Auto	Disable	Auto	---	---	---	---	---
<input type="checkbox"/>	2	Disable	128	Auto	Auto	Disable	Auto	---	---	---	---	---
<input type="checkbox"/>	3	Disable	128	Auto	Auto	Disable	Auto	---	---	---	---	---
<input type="checkbox"/>	4	Disable	128	Auto	Auto	Disable	Auto	---	---	---	---	---
<input type="checkbox"/>	5	Disable	128	Auto	Auto	Disable	Auto	---	---	---	---	---
<input type="checkbox"/>	6	Disable	128	Auto	Auto	Disable	Auto	---	---	---	---	---
<input type="checkbox"/>	7	Disable	128	Auto	Auto	Disable	Auto	---	---	---	---	---
<input type="checkbox"/>	8	Disable	128	Auto	Auto	Disable	Auto	---	---	---	---	---
<input type="checkbox"/>	9	Disable	128	Auto	Auto	Disable	Auto	---	---	---	---	---
<input type="checkbox"/>	10	Disable	128	Auto	Auto	Disable	Auto	---	---	---	---	---
<input type="checkbox"/>	11	Disable	128	Auto	Auto	Disable	Auto	---	---	---	---	---
<input type="checkbox"/>	12	Disable	128	Auto	Auto	Disable	Auto	---	---	---	---	---
<input type="checkbox"/>	13	Disable	128	Auto	Auto	Disable	Auto	---	---	---	---	---
<input type="checkbox"/>	14	Disable	128	Auto	Auto	Disable	Auto	---	---	---	---	---
<input type="checkbox"/>	15	Disable	128	Auto	Auto	Disable	Auto	---	---	---	---	---

Note:
If the Path Cost of a port is set to 0, it will alter automatically according to the port's link speed.

Figure 7-6 Port Config

The following entries are displayed on this screen:

➤ **Port Config**

- Port Select:** Click the **Select** button to quick-select the corresponding port based on the port number you entered.
- Select:** Select the desired port for STP configuration. It is multi-optional.
- Port:** Displays the port number of the switch.
- Status:** Select Enable /Disable STP function for the desired port.
- Priority:** Enter a value from 0 to 240 divisible by 16. Port priority is an important criterion on determining if the port connected to this port will be chosen as the root port. The lower value has the higher priority.
- ExtPath Cost:** ExtPath Cost is used to choose the path and calculate the path costs of ports in different MST regions. It is an important criterion on determining the root port. The lower value has the higher priority.
- IntPath Cost:** IntPath Cost is used to choose the path and calculate the path costs of ports in an MST region. It is an important criterion on determining the root port. The lower value has the higher priority.
- Edge Port:** Select Enable/Disable Edge Port. The edge port can transit its state from blocking to forwarding rapidly without waiting for forward delay.
- P2P Link:** Select the P2P link status. If the two ports in the P2P link are root port or designated port, they can transit their states to forwarding rapidly to reduce the unnecessary forward delay.
- MCheck:** Select Enable to perform MCheck operation on the port. Unchange means no MCheck operation.
- STP Version:** Displays the STP version of the port.
- Port Role:** Displays the role of the port played in the STP Instance.

- Root Port: Indicates the port that has the lowest path cost from this bridge to the Root Bridge and forwards packets to the root.
- Designated Port: Indicates the port that forwards packets to a downstream network segment or switch.
- Master Port: Indicates the port that connects a MST region to the common root. The path from the master port to the common root is the shortest path between this MST region and the common root.
- Alternate Port: Indicates the port that can be a backup port of a root or master port.
- Backup Port: Indicates the port that is the backup port of a designated port.
- Disabled: Indicates the port that is not participating in the STP.

Port Status:

Displays the working status of the port.

- Forwarding: In this status the port can receive/forward data, receive/send BPDU packets as well as learn MAC address.
- Learning: In this status the port can receive/send BPDU packets and learn MAC address.
- Blocking: In this status the port can only receive BPDU packets.
- Disconnected: In this status the port is not participating in the STP.

LAG:

Displays the LAG number which the port belongs to.



Note:

1. Configure the ports connected directly to terminals as edge ports and enable the BPDU protection function as well. This not only enables these ports to transit to forwarding state rapidly but also secures your network.
2. All the links of ports in a LAG can be configured as point-to-point links.
3. When the link of a port is configured as a point-to-point link, the spanning tree instances owning this port are configured as point-to-point links. If the physical link of a port is not a point-to-point link and you forcibly configure the link as a point-to-point link, temporary loops may be incurred.

7.3 MSTP Instance

MSTP combines VLANs and spanning tree together via VLAN-to-instance mapping table (VLAN-to-spanning-tree mapping). By adding MSTP instances, it binds several VLANs to an instance to realize the load balance based on instances.

Only when the switches have the same MST region name, MST region revision and VLAN-to-Instance mapping table, the switches can be regarded as in the same MST region.

The MSTP Instance function can be implemented on **Region Config**, **Instance Config** and **Instance Port Config** pages.

7.3.1 Region Config

On this page you can configure the name and revision of the MST region

Choose the menu **Spanning Tree**→**MSTP Instance**→**Region Config** to load the following page.

Region Config

Region Name:

Revision: (0-65535)

Figure 7-7 Region Config

The following entries are displayed on this screen:

➤ **Region Config**

- Region Name:** Create a name for MST region identification using up to 32 characters.
- Revision:** Enter the revision from 0 to 65535 for MST region identification.

7.3.2 Instance Config

Instance Configuration, a property of MST region, is used to describe the VLAN to Instance mapping configuration. You can assign VLAN to different instances appropriate to your needs. Every instance is a VLAN group independent of other instances and CIST.

Choose the menu **Spanning Tree**→**MSTP Instance**→**Instance Config** to load the following page.

Instance Table

Select	Instance	Status	Priority	VLAN ID	
<input type="checkbox"/>			<input type="text"/>	<input type="text"/>	
<input type="checkbox"/>	1	Disable	32768		<input type="button" value="Clear"/>
<input type="checkbox"/>	2	Disable	32768		<input type="button" value="Clear"/>
<input type="checkbox"/>	3	Disable	32768		<input type="button" value="Clear"/>
<input type="checkbox"/>	4	Disable	32768		<input type="button" value="Clear"/>
<input type="checkbox"/>	5	Disable	32768		<input type="button" value="Clear"/>
<input type="checkbox"/>	6	Disable	32768		<input type="button" value="Clear"/>
<input type="checkbox"/>	7	Disable	32768		<input type="button" value="Clear"/>
<input type="checkbox"/>	8	Disable	32768		<input type="button" value="Clear"/>
	CIST	Enable	32768	1-4094,	

VLAN-Instance Mapping

VLAN ID: (1-4094)

Instance ID: (0-8, 0 is the cist)

Note:

The format of input VLAN ID should be like '1, 3, 4-7, 11-30' in the range from 1 to 4094.

Figure 7-8 Instance Config

The following entries are displayed on this screen:

➤ **Instance Table**

Instance ID Select: Click the **Select** button to quick-select the corresponding Instance ID based on the ID number you entered.

Select: Select the desired Instance ID for configuration. It is multi-optional.

Instance: Displays Instance ID of the switch.

Status: Select Enable/Disable the instance.

Priority: Enter the priority of the switch in the instance. It is an important criterion on determining if the switch will be chosen as the root bridge in the specific instance.

VLAN ID: Enter the VLAN ID which belongs to the corresponding instance ID. After modification here, the previous VLAN ID will be cleared and mapped to the CIST.

Clear: Click the **Clear** button to clear up all VLAN IDs from the instance ID. The cleared VLAN ID will be automatically mapped to the CIST.

➤ **VLAN-Instance Mapping**

VLAN ID: Enter the desired VLAN ID. After modification here, the new VLAN ID will be added to the corresponding instance ID and the previous VLAN ID won't be replaced.

Instance ID: Enter the corresponding instance ID.



Note:

In a network with both GVRP and MSTP enabled, GVRP packets are forwarded along the CIST. If you want to broadcast packets of a specific VLAN through GVRP, please be sure to map the VLAN to the CIST when configuring the MSTP VLAN-instance mapping table.

7.3.3 Instance Port Config

A port can play different roles in different spanning tree instance. On this page you can configure the parameters of the ports in different instance IDs as well as view status of the ports in the specified instance.

Choose the menu **Spanning Tree**→**MSTP Instance**→**Instance Port Config** to load the following page.

Port Config

Instance ID Port

Select	Port	Priority	Path Cost	Port Role	Port Status	LAG
<input type="checkbox"/>		<input type="text"/>	<input type="text"/>			
<input type="checkbox"/>	1	128	Auto	---	---	---
<input type="checkbox"/>	2	128	Auto	---	---	---
<input type="checkbox"/>	3	128	Auto	---	---	---
<input type="checkbox"/>	4	128	Auto	---	---	---
<input type="checkbox"/>	5	128	Auto	---	---	---
<input type="checkbox"/>	6	128	Auto	---	---	---
<input type="checkbox"/>	7	128	Auto	---	---	---
<input type="checkbox"/>	8	128	Auto	---	---	---
<input type="checkbox"/>	9	128	Auto	---	---	---
<input type="checkbox"/>	10	128	Auto	---	---	---
<input type="checkbox"/>	11	128	Auto	---	---	---
<input type="checkbox"/>	12	128	Auto	---	---	---
<input type="checkbox"/>	13	128	Auto	---	---	---
<input type="checkbox"/>	14	128	Auto	---	---	---
<input type="checkbox"/>	15	128	Auto	---	---	---

Note:

If the Path Cost of a port is set to 0, it will alter automatically according to the port's link speed.

Figure 7-9 Instance Port Config

The following entries are displayed on this screen:

➤ **Port Config**

- Instance ID:** Select the desired instance ID for its port configuration.
- Port Select:** Click the **Select** button to quick-select the corresponding port based on the port number you entered.
- Select:** Select the desired port to specify its priority and path cost. It is multi-optional.
- Port:** Displays the port number of the switch.
- Priority:** Enter the priority of the port in the instance. It is an important criterion on determining if the port connected to this port will be chosen as the root port.
- Path Cost:** Path Cost is used to choose the path and calculate the path costs of ports in an MST region. It is an important criterion on determining the root port. The lower value has the higher priority.
- Port Role:** Displays the role of the port played in the MSTP Instance.
- Port Status:** Displays the working status of the port.

LAG: Displays the LAG number which the port belongs to.



Note:

The port status of one port in different spanning tree instances can be different.

Global configuration Procedure for Spanning Tree function:

Step	Operation	Description
1	Make clear roles the switches play in spanning tree instances: root bridge or designated bridge	Preparation.
2	Globally configure MSTP parameters	Required. Enable Spanning Tree function on the switch and configure MSTP parameters on Spanning Tree → STP Config → STP Config page.
3	Configure MSTP parameters for ports	Required. Configure MSTP parameters for ports on Spanning Tree → Port Config → Port Config page.
4	Configure the MST region	Required. Create MST region and configure the role the switch plays in the MST region on Spanning Tree → MSTP Instance → Region Config and Instance Config page.
5	Configure MSTP parameters for instance ports	Optional. Configure different instances in the MST region and configure MSTP parameters for instance ports on Spanning Tree → MSTP Instance → Instance Port Config page.

7.4 STP Security

Configuring protection function for devices can prevent devices from any malicious attack against STP features. The STP Security function can be implemented on **Port Protect** and **TC Protect** pages.

Port Protect function is to prevent the devices from any malicious attack against STP features.

7.4.1 Port Protect

On this page you can configure loop protect feature, root protect feature, TC protect feature, BPDU protect feature and BPDU filter feature for ports. You are suggested to enable corresponding protection feature for the qualified ports.

➤ Loop Protect

In a stable network, a switch maintains the states of ports by receiving and processing BPDU packets from the upstream switch. However, when link congestions or link failures occurred to the network, a down stream switch does not receive BPDU packets for certain period, which results in spanning trees being regenerated and roles of ports being reselected, and causes the blocked ports to transit to forwarding state. Therefore, loops may be incurred in the network.

The loop protect function can suppresses loops. With this function enabled, a port, regardless of the role it plays in instances, is always set to blocking state, when the port does not receive BPDU

packets from the upstream switch and spanning trees are regenerated, and thereby loops can be prevented.

➤ **Root Protect**

A CIST and its secondary root bridges are usually located in the high-bandwidth core region. Wrong configuration or malicious attacks may result in configuration BPDU packets with higher priorities being received by the legal root bridge, which causes the current legal root bridge to lose its position and network topology jitter to occur. In this case, flows that should travel along high-speed links may lead to low-speed links, and network congestion may occur.

To avoid this, MSTP provides root protect function. Ports with this function enabled can only be set as designated ports in all spanning tree instances. When a port of this type receives BPDU packets with higher priority, it transits its state to blocking state and stops forwarding packets (as if it is disconnected from the link). The port resumes the normal state if it does not receive any configuration BPDU packets with higher priorities for a period of two times of forward delay.

➤ **TC Protect**

A switch removes MAC address entries upon receiving TC-BPDU packets. If a user maliciously sends a large amount of TC-BPDU packets to a switch in a short period, the switch will be busy with removing MAC address entries, which may decrease the performance and stability of the network.

To prevent the switch from frequently removing MAC address entries, you can enable the TC protect function on the switch. With TC protect function enabled, if the account number of the received TC-BPDUs exceeds the maximum number you set in the TC threshold field, the switch will not perform the removing operation in the TC protect cycle. Such a mechanism prevents the switch from frequently removing MAC address entries.

➤ **BPDU Protect**

Ports of the switch directly connected to PCs or servers are configured as edge ports to rapidly transit their states. When these ports receive BPDUs, the system automatically configures these ports as non-edge ports and regenerates spanning trees, which may cause network topology jitter. Normally these ports do not receive BPDUs, but if a user maliciously attacks the switch by sending BPDUs, network topology jitter occurs.

To prevent this attack, MSTP provides BPDU protect function. With this function enabled on the switch, the switch shuts down the edge ports that receive BPDUs and reports these cases to the administrator. If a port is shut down, only the administrator can restore it.

➤ **BPDU Filter**

BPDU filter function is to prevent BPDUs flood in the STP network. If a switch receives malicious BPDUs, it forwards these BPDUs to the other switched in the network, which may result in spanning trees being continuously regenerated. In this case, the switch occupying too much CPU or the protocol status of BPDUs is wrong.

With BPDU filter function enabled, a port does not receive or forward BPDUs, but it sends out its own BPDUs. Such a mechanism prevents the switch from being attacked by BPDUs so as to guarantee generation the spanning trees correct.

Choose the menu **Spanning Tree**→**STP Security**→**Port Protect** to load the following page.

Port Protect

Port

Select	Port	Loop Protect	Root Protect	TC Protect	BPDU Protect	BPDU Filter	LAG
<input type="checkbox"/>		Disable ▾	Disable ▾	Disable ▾	Disable ▾	Disable ▾	
<input type="checkbox"/>	1	Disable	Disable	Disable	Disable	Disable	---
<input type="checkbox"/>	2	Disable	Disable	Disable	Disable	Disable	---
<input type="checkbox"/>	3	Disable	Disable	Disable	Disable	Disable	---
<input type="checkbox"/>	4	Disable	Disable	Disable	Disable	Disable	---
<input type="checkbox"/>	5	Disable	Disable	Disable	Disable	Disable	---
<input type="checkbox"/>	6	Disable	Disable	Disable	Disable	Disable	---
<input type="checkbox"/>	7	Disable	Disable	Disable	Disable	Disable	---
<input type="checkbox"/>	8	Disable	Disable	Disable	Disable	Disable	---
<input type="checkbox"/>	9	Disable	Disable	Disable	Disable	Disable	---
<input type="checkbox"/>	10	Disable	Disable	Disable	Disable	Disable	---
<input type="checkbox"/>	11	Disable	Disable	Disable	Disable	Disable	---
<input type="checkbox"/>	12	Disable	Disable	Disable	Disable	Disable	---
<input type="checkbox"/>	13	Disable	Disable	Disable	Disable	Disable	---
<input type="checkbox"/>	14	Disable	Disable	Disable	Disable	Disable	---
<input type="checkbox"/>	15	Disable	Disable	Disable	Disable	Disable	---

Figure 7-10 Port Protect

The following entries are displayed on this screen:

➤ **Port Protect**

Port Select: Click the **Select** button to quick-select the corresponding port based on the port number you entered.

Select: Select the desired port for port protect configuration. It is multi-optional.

Port: Displays the port number of the switch.

Loop Protect: Loop Protect is to prevent the loops in the network brought by recalculating STP because of link failures and network congestions.

Root Protect: Root Protect is to prevent wrong network topology change caused by the role change of the current legal root bridge.

TC Protect: TC Protect is to prevent the decrease of the performance and stability of the switch brought by continuously removing MAC address entries upon receiving TC-BPDUs in the STP network.

BPDU Protect: BPDU Protect is to prevent the edge port from being attacked by maliciously created BPDUs

BPDU Filter: BPDU Filter is to prevent BPDUs flood in the STP network.

LAG: Displays the LAG number which the port belongs to.

7.4.2 TC Protect

When TC Protect is enabled for the port on **Port Protect** page, the TC threshold and TC protect cycle need to be configured on this page.

Choose the menu **Spanning Tree**→**STP Security**→**TC Protect** to load the following page.

TC Protect

TC Threshold:	<input style="width: 80%;" type="text" value="20"/>	packet (1-100)	
TC Protect Cycle:	<input style="width: 80%;" type="text" value="5"/>	sec (1-10)	
			<input type="button" value="Apply"/>
			<input type="button" value="Help"/>

Figure 7-11 TC Protect

The following entries are displayed on this screen:

➤ **TC Protect**

TC Threshold: Enter a number from 1 to 100. It is the maximum number of the TC-BPDUs received by the switch in a TC Protect Cycle. The default value is 20.

TC Protect Cycle: Enter a value from 1 to 10 to specify the TC Protect Cycle. The default value is 5.

7.5 Application Example for STP Function

➤ **Network Requirements**

- Switch A, B, C, D and E all support MSTP function.
- A is the central switch.
- B and C are switches in the convergence layer. D, E and F are switches in the access layer.
- There are 6 VLANs labeled as VLAN101-VLAN106 in the network.
- All switches run MSTP and belong to the same MST region.
- The data in VLAN101, 103 and 105 are transmitted in the STP with B as the root bridge. The data in VLAN102, 104 and 106 are transmitted in the STP with C as the root bridge.

➤ **Network Diagram**

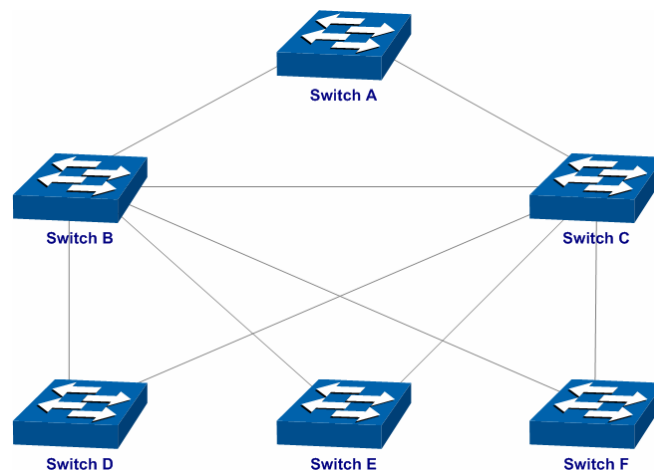

➤ **Configuration Procedure**

● **Configure Switch A:**

Step	Operation	Description
1	Configure ports	On VLAN→802.1Q VLAN page, configure the link type of the related ports as Trunk, and add the ports to VLAN101-VLAN106. The detailed instructions can be found in the section <u>802.1Q VLAN</u> .
2	Enable STP function	On Spanning Tree→STP Config→STP Config page, enable STP function and select MSTP version. On Spanning Tree→STP Config→Port Config page, enable MSTP function for the port.
3	Configure the region name and the revision of MST region	On Spanning Tree→MSTP Instance→Region Config page, configure the region as TP-LINK and keep the default revision setting.
4	Configure VLAN-to-Instance mapping table of the MST region	On Spanning Tree→MSTP Instance→Instance Config page, configure VLAN-to-Instance mapping table. Map VLAN 101, 103 and 105 to Instance 1; map VLAN 102, 104 and 106 to Instance 2.

● **Configure Switch B:**

Step	Operation	Description
1	Configure ports	On VLAN→802.1Q VLAN page, configure the link type of the related ports as Trunk, and add the ports to VLAN101-VLAN106. The detailed instructions can be found in the section <u>802.1Q VLAN</u> .
2	Enable STP function	On Spanning Tree→STP Config→STP Config page, enable STP function and select MSTP version. On Spanning Tree→STP Config→Port Config page, enable MSTP function for the port.
3	Configure the region name and the revision of MST region	On Spanning Tree→MSTP Instance→Region Config page, configure the region as TP-LINK and keep the default revision setting.
4	Configure VLAN-to-Instance mapping table of the MST region	On Spanning Tree→MSTP Instance→Instance Config page, configure VLAN-to-Instance mapping table. Map VLAN 101, 103 and 105 to Instance 1; map VLAN 102, 104 and 106 to Instance 2.
5	Configure switch B as the root bridge of Instance 1	On Spanning Tree→MSTP Instance→Instance Config page, configure the priority of Instance 1 to be 0.
6	Configure switch B as the designated bridge of Instance 2	On Spanning Tree→MSTP Instance→Instance Config page, configure the priority of Instance 2 to be 4096.

- Configure Switch C:

Step	Operation	Description
1	Configure ports	On VLAN → 802.1Q VLAN page, configure the link type of the related ports as Trunk, and add the ports to VLAN101-VLAN106. The detailed instructions can be found in the section 802.1Q VLAN .
2	Enable STP function	On Spanning Tree → STP Config → STP Config page, enable STP function and select MSTP version. On Spanning Tree → STP Config → Port Config page, enable MSTP function for the port.
3	Configure the region name and the revision of MST region	On Spanning Tree → MSTP Instance → Region Config page, configure the region as TP-LINK and keep the default revision setting.
4	Configure VLAN-to-Instance mapping table of the MST region	On Spanning Tree → MSTP Instance → Instance Config page, configure VLAN-to-Instance mapping table. Map VLAN 101, 103 and 105 to Instance 1; map VLAN 102, 104 and 106 to Instance 2.
5	Configure switch C as the root bridge of Instance 1	On Spanning Tree → MSTP Instance → Instance Config page, configure the priority of Instance 1 to be 4096.
6	Configure switch C as the root bridge of Instance 2	On Spanning Tree → MSTP Instance → Instance Config page, configure the priority of Instance 2 to be 0.

- Configure Switch D:

Step	Operation	Description
1	Configure ports	On VLAN → 802.1Q VLAN page, configure the link type of the related ports as Trunk, and add the ports to VLAN101-VLAN106. The detailed instructions can be found in the section 802.1Q VLAN .
2	Enable STP function	On Spanning Tree → STP Config → STP Config page, enable STP function and select MSTP version. On Spanning Tree → STP Config → Port Config page, enable MSTP function for the port.
3	Configure the region name and the revision of MST region	On Spanning Tree → MSTP Instance → Region Config page, configure the region as TP-LINK and keep the default revision setting.
4	Configure VLAN-to-Instance mapping table of the MST region	On Spanning Tree → MSTP Instance → Instance Config page, configure VLAN-to-Instance mapping table. Map VLAN 101, 103 and 105 to Instance 1; map VLAN 102, 104 and 106 to Instance 2.

- The configuration procedure for switch E and F is the same with that for switch D.

➤ **The topology diagram of the two instances after the topology is stable**

- For Instance 1 (VLAN 101, 103 and 105), the red paths in the following figure are connected links; the gray paths are the blocked links.

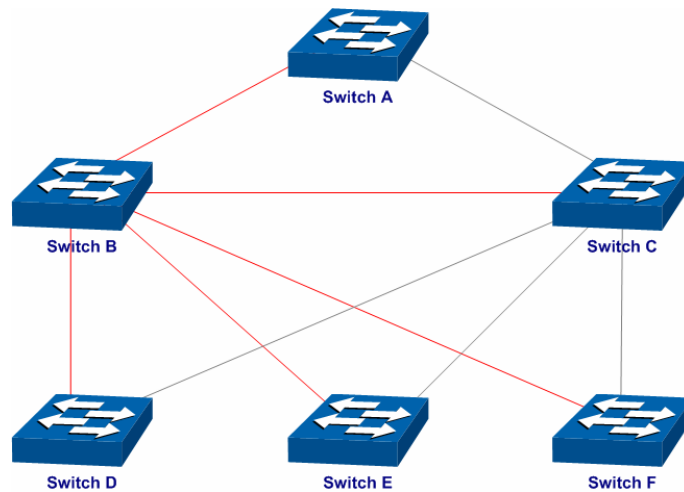

- For Instance 2 (VLAN 102, 104 and 106), the blue paths in the following figure are connected links; the gray paths are the blocked links.

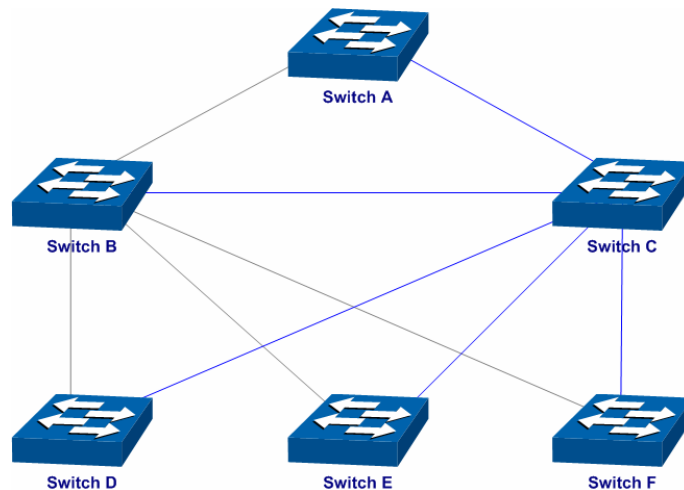

➤ **Suggestion for Configuration**

- Enable TC Protect function for all the ports of switches.
- Enable Root Protect function for all the ports of root bridges.
- Enable Loop Protect function for the non-edge ports.

Enable BPDU Protect function or BPDU Filter function for the edge ports which are connected to the PC and server.

[Return to CONTENTS](#)

Chapter 8 Multicast

➤ Multicast Overview

In the network, packets are sent in three modes: unicast, broadcast and multicast. In unicast, the source server sends separate copy information to each receiver. When a large number of users require this information, the server must send many pieces of information with the same content to the users. Therefore, large bandwidth will be occupied. In broadcast, the system transmits information to all users in a network. Any user in the network can receive the information, no matter the information is needed or not.

Point-to-multipoint multimedia business, such as video conferences and VoD (video-on-demand), plays an important part in the information transmission field. Suppose a point to multi-point service is required, unicast is suitable for networks with sparsely users, whereas broadcast is suitable for networks with densely distributed users. When the number of users requiring this information is not certain, unicast and broadcast deliver a low efficiency. Multicast solves this problem. It can deliver a high efficiency to send data in the point to multi-point service, which can save large bandwidth and reduce the network load. In multicast, the packets are transmitted in the following way as shown in Figure 8-1.

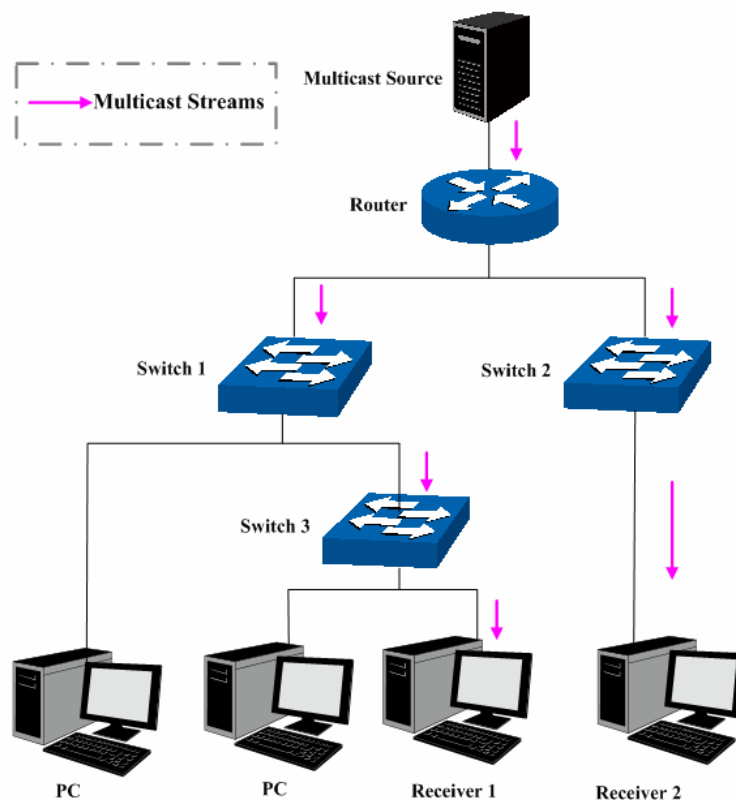

Figure 8-1 Information transmission in the multicast mode

Features of multicast:

1. The number of receivers is not certain. Usually point-to-multipoint transmission is needed;
2. Multiple users receiving the same information from a multicast group. The multicast information sender just need to send the information to the network device once;
3. Each user can join and leave the multicast group at any time;

4. Real time is highly demanded and certain packets drop is allowed.

➤ **Multicast Address**

1. Multicast IP Address:

As specified by IANA (Internet Assigned Numbers Authority), Class D IP addresses are used as destination addresses of multicast packets. The multicast IP addresses range from 224.0.0.0~239.255.255.255. The following table displays the range and description of several special multicast IP addresses.

Multicast IP address range	Description
224.0.0.0~224.0.0.255	Reserved multicast addresses for routing protocols and other network protocols
224.0.1.0~224.0.1.255	Addresses for video conferencing
239.0.0.0~239.255.255.255	Local management multicast addresses, which are used in the local network only

Table 8-1 Range of the special multicast IP

2. Multicast MAC Address:

When a unicast packet is transmitted in an Ethernet network, the destination MAC address is the MAC address of the receiver. When a multicast packet is transmitted in an Ethernet network, the destination is not a receiver but a group with uncertain number of members, so a multicast MAC address, a logical MAC address, is needed to be used as the destination address.

As stipulated by IANA, the high-order 24 bits of a multicast MAC address begins with 01-00-5E while the low-order 23 bits of a multicast MAC address are the low-order 23 bits of the multicast IP address. The mapping relationship is described as Figure 8-2.

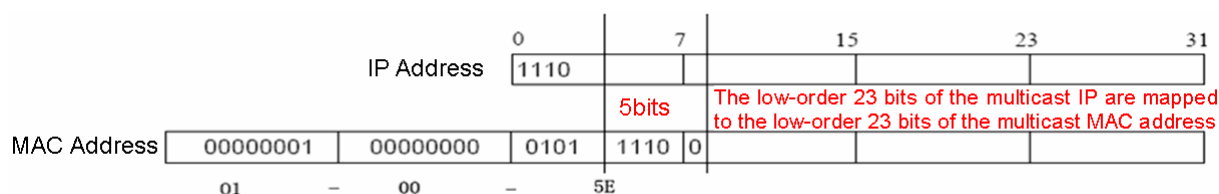

Figure 8-2 Mapping relationship between multicast IP address and multicast MAC address

The high-order 4 bits of the IP multicast address are 1110, identifying the multicast group. Only 23 bits of the remaining low-order 28 bits are mapped to a multicast MAC address. In that way, 5 bits of the IP multicast address is not utilized. As a result, 32 IP multicast addresses are mapped to the same MAC address.

➤ **Multicast Address Table**

The switch is forwarding multicast packets based on the multicast address table. As the transmission of multicast packets can not span the VLAN, the first part of the multicast address table is VLAN ID, based on which the received multicast packets are forwarded in the VLAN owning the receiving port. The multicast address table is not mapped to an egress port but a group port list. When forwarding a multicast packet, the switch looks up the multicast address table based on the destination multicast address of the multicast packet. If the corresponding entry can not be found in the table, the switch will broadcast the packet in the VLAN owning the receiving port. If the corresponding entry can be found in the table, it indicates that the destination address

should be a group port list, so the switch will duplicate this multicast data and deliver each port one copy. The general format of the multicast address table is described as Figure 8-3 below.

VLAN ID	Multicast IP	Port
---------	--------------	------

Figure 8-3 Multicast Address Table

➤ IGMP Snooping

In the network, the hosts apply to the near Router for joining (leaving) a multicast group by sending IGMP (Internet Group Management Protocol) messages. When the up-stream device forwards down the multicast data, the switch is responsible for sending them to the hosts. IGMP Snooping is a multicast control mechanism, which can be used on the switch for dynamic registration of the multicast group. The switch, running IGMP Snooping, manages and controls the multicast group via listening to and processing the IGMP messages transmitted between the hosts and the multicast router, thereby effectively prevents multicast groups being broadcasted in the network.

The Multicast module is mainly for multicast management configuration of the switch, including four submenus: **IGMP Snooping**, **Multicast IP**, **Multicast Filter** and **Packet Statistics**.

8.1 IGMP Snooping

➤ IGMP Snooping Process

The switch, running IGMP Snooping, listens to the IGMP messages transmitted between the host and the router, and tracks the IGMP messages and the registered port. When receiving IGMP report message, the switch adds the port to the multicast address table; when the switch listens to IGMP leave message from the host, the router sends the Group-Specific Query message of the port to check if other hosts need this multicast, if yes, the router will receive IGMP report message; if no, the router will receive no response from the hosts and the switch will remove the port from the multicast address table. The router regularly sends IGMP query messages. After receiving the IGMP query messages, the switch will remove the port from the multicast address table if the switch receives no IGMP report message from the host within a period of time.

➤ IGMP Messages

The switch, running IGMP Snooping, processes the IGMP messages of different types as follows.

1. IGMP Query Message

IGMP query message, sent by the router, falls into two types, IGMP general query message and IGMP group-specific-query message. The router regularly sends IGMP general message to query if the multicast groups contain any member. When receiving IGMP leave message, the receiving port of the router will send IGMP group-specific-query message to the multicast group and the switch will forward IGMP group-specific-query message to check if other members in the multicast group of the port need this multicast.

When receiving IGMP general query message, the switch will forward them to all other ports in the VLAN owning the receiving port. The receiving port will be processed: if the receiving port is not a router port yet, it will be added to the router port list with its router port time specified; if the receiving port is already a router port, its router port time will be directly reset.

When receiving IGMP group-specific-query message, the switch will send the group-specific query message to the members of the multicast group being queried.

2. IGMP Report Message

IGMP report message is sent by the host when it applies for joining a multicast group or responses to the IGMP query message from the router.

When receiving IGMP report message, the switch will send the report message via the router port in the VLAN as well as analyze the message to get the address of the multicast group the host applies for joining. The receiving port will be processed: if the receiving port is a new member port, it will be added to the multicast address table with its member port time specified; if the receiving port is already a member port, its member port time will be directly reset.

3. IGMP Leave Message

The host, running IGMPv1, does not send IGMP leave message when leaving a multicast group, as a result, the switch can not get the leave information of the host momentarily. However, after leaving the multicast group, the host does not send IGMP report message any more, so the switch will remove the port from the corresponding multicast address table when its member port time times out. The host, running IGMPv2 or IGMPv3, sends IGMP leave message when leaving a multicast group to inform the multicast router of its leaving.

When receiving IGMP leave message, the switch will forward IGMP group-specific-query message to check if other members in the multicast group of the port need this multicast and reset the member port time to the leave time. When the leave time times out, the switch will remove the port from the corresponding multicast group. If no other member is in the group after the port is removed, the switch will remove the whole multicast group and send IGMP leave message to the router.

➤ IGMP Snooping Fundamentals

1. Ports

Router Port: Indicates the switch port directly connected to the multicast router.

Member Port: Indicates a switch port connected to a multicast group member.

2. Timers

Router Port Time: Within the time, if the switch does not receive IGMP query message from the router port, it will consider this port is not a router port any more. The default value is 300 seconds.

Member Port Time: Within the time, if the switch does not receive IGMP report message from the member port, it will consider this port is not a member port any more. The default value is 260 seconds.

Leave Time: Indicates the interval between the switch receiving a leave message from a host and the switch removing the host from the multicast groups. The default value is 1 second.

The IGMP Snooping function can be implemented on **Snooping Config**, **Port Config**, **VLAN Config** and **Multicast VLAN** pages.

8.1.1 Snooping Config

To configure the IGMP Snooping on the switch, please firstly configure IGMP global configuration and related parameters on this page.

If the multicast address of the received multicast data is not in the multicast address table, the switch will broadcast the data in the VLAN. When Unknown Multicast Discard feature is enabled, the switch drops the received unknown multicast so as to save the bandwidth and enhance the process efficiency of the system. Please configure this feature appropriate to your needs.

Choose the menu **Multicast**→**IGMP Snooping**→**Snooping Config** to load the following page.

Global Config

IGMP Snooping: Enable Disable

Unknown Multicast: Forward Discard

IGMP Snooping Status

Description	Member
Enabled Port	
Enabled VLAN	

Note:

IGMP Snooping will take effect only when Global Config, Port Config and VLAN Config are all enabled.

Figure 8-4 Basic Config

The following entries are displayed on this screen:

➤ **Global Config**

IGMP Snooping: Select Enable/Disable IGMP Snooping function globally on the Switch.

Unknown Multicast: Select the operation for the switch to process unknown multicast, Forward or Discard.

➤ **IGMP Snooping Status**

Description: Displays IGMP Snooping status.

Member: Displays the member of the corresponding status.

8.1.2 Port Config

On this page you can configure the IGMP feature for ports of the switch.

Choose the menu **Multicast**→**IGMP Snooping**→**Port Config** to load the following page.

Select	Port	IGMP Snooping	Fast Leave	LAG
<input type="checkbox"/>		Disable	Disable	
<input type="checkbox"/>	1	Disable	Disable	---
<input type="checkbox"/>	2	Disable	Disable	---
<input type="checkbox"/>	3	Disable	Disable	---
<input type="checkbox"/>	4	Disable	Disable	---
<input type="checkbox"/>	5	Disable	Disable	---
<input type="checkbox"/>	6	Disable	Disable	---
<input type="checkbox"/>	7	Disable	Disable	---
<input type="checkbox"/>	8	Disable	Disable	---
<input type="checkbox"/>	9	Disable	Disable	---
<input type="checkbox"/>	10	Disable	Disable	---
<input type="checkbox"/>	11	Disable	Disable	---
<input type="checkbox"/>	12	Disable	Disable	---

Figure 8-5 Port Config

The following entries are displayed on this screen:

➤ **Port Config**

- Port Select:** Click the **Select** button to quick-select the corresponding port based on the port number you entered.
- Select:** Select the desired port for IGMP Snooping feature configuration. It is multi-optional.
- Port:** Displays the port of the Switch.
- IGMP Snooping:** Select Enable/Disable IGMP Snooping for the desired port.
- Fast Leave:** Select Enable/Disable Fast Leave feature for the desired port. If Fast Leave is enabled for a port, the Switch will immediately remove this port from the multicast group upon receiving IGMP leave messages.
- LAG:** Displays the LAG number which the port belongs to.

 **Note:**

- Fast Leave on the port is effective only when the host supports IGMPv2 or IGMPv3.
- When both Fast Leave feature and Unknown Multicast Discard feature are enabled, the leaving of a user connected to a port owning multi-user will result in the other users intermitting the multicast business.

8.1.3 VLAN Config

Multicast groups established by IGMP Snooping are based on VLANs. On this page you can configure different IGMP parameters for different VLANs.

Choose the menu **Multicast**→**IGMP Snooping**→**VLAN Config** to load the following page.

VLAN Config

VLAN ID: (1-4094)

Router Port Time: sec (60-600, recommended: 300)

Member Port Time: sec (60-600, recommended: 260)

Leave Time: sec (1-30, recommended: 1)

Static Router Ports: (Format: 1-3,6,8)

VLAN Table

						VLAN ID <input type="text"/>	<input type="button" value="Select"/>
Select	VLAN ID	Router Port Time	Member Port Time	Leave Time	Router Port		
<input type="checkbox"/>		<input type="text"/>	<input type="text"/>	<input type="text"/>	<input type="text"/>		
<input type="button" value="Apply"/> <input type="button" value="Delete"/> <input type="button" value="Help"/>							

Note:
The settings here will be invalid when multicast VLAN is enabled.

Figure 8-6 VLAN Config

The following entries are displayed on this screen:

➤ **VLAN Config**

- VLAN ID:** Enter the VLAN ID to enable IGMP Snooping for the desired VLAN.
- Router Port Time:** Specify the aging time of the router port. Within this time, if the switch doesn't receive IGMP query message from the router port, it will consider this port is not a router port any more.
- Member Port Time:** Specify the aging time of the member port. Within this time, if the switch doesn't receive IGMP report message from the member port, it will consider this port is not a member port any more.
- Leave Time:** Specify the interval between the switch receiving a leave message from a host and the switch removing the host from the multicast groups.
- Static Router Port:** Select the static router port which is mainly used in the network with stable topology.

➤ **VLAN Table**

- VLAN ID Select:** Click the **Select** button to quick-select the corresponding VLAN ID based on the ID number you entered.
- Select:** Select the desired VLAN ID for configuration. It is multi-optional.
- VLAN ID:** Displays the VLAN ID.
- Router Port Time:** Displays the router port time of the VLAN.

Member Port Time: Displays the member port time of the VLAN.

Leave Time: Displays the leave time of the VLAN.

Router Port: Displays the router port of the VLAN.



Note:

The settings here will be invalid when multicast VLAN is enabled

Configuration procedure:

Step	Operation	Description
1	Enable IGMP Snooping function	Required. Enable IGMP Snooping globally on the switch and for the port on Multicast→IGMP Snooping→Snooping Config and Port Config page .
2	Configure the multicast parameters for VLANs	Optional. Configure the multicast parameters for VLANs on Multicast→IGMP Snooping→VLAN Config page . If a VLAN has no multicast parameters configuration, it indicates the IGMP Snooping is not enabled in the VLAN, thus the multicast data in the VLAN will be broadcasted.

8.1.4 Multicast VLAN

In old multicast transmission mode, when users in different VLANs apply for join the same multicast group, the multicast router will duplicate this multicast information and deliver each VLAN owning a receiver one copy. This mode wastes a lot of bandwidth.

The problem above can be solved by configuring a multicast VLAN. By adding switch ports to the multicast VLAN and enabling IGMP Snooping, you can make users in different VLANs share the same multicast VLAN. This saves the bandwidth since multicast streams are transmitted only within the multicast VLAN and also guarantees security because the multicast VLAN is isolated from user VLANs.

Before configuring a multicast VLAN, you should firstly configure a VLAN as multicast VLAN and add the corresponding ports to the VLAN on the **802.1Q VLAN** page. If the multicast VLAN is enabled, the multicast configuration for other VLANs on the **VLAN Config** page will be invalid, that is, the multicast streams will be transmitted only within the multicast VLAN.

Choose the menu **Multicast→IGMP Snooping→Multicast VLAN** to load the following page.

Multicast VLAN			
Multicast VLAN:	<input type="radio"/> Enable	<input checked="" type="radio"/> Disable	
VLAN ID:	<input type="text"/>	(2-4094)	
Router Port Time:	<input type="text"/>	sec (60-600, recommended: 300)	<input type="button" value="Apply"/> <input type="button" value="Help"/>
Member Port Time:	<input type="text"/>	sec (60-600, recommended: 260)	
Leave Time:	<input type="text"/>	sec (1-30, recommended: 1)	
Router Ports:	<input type="text"/>	(Format: 1-3,6,8)	

Note:

1. All IGMP packet will be processed in the Multicast VLAN after Multicast VLAN is created.
2. The Multicast VLAN won't take effect unless you first complete the configuration on the VLAN Config page.

Figure 8-7 Multicast VLAN

The following entries are displayed on this screen:

➤ **Multicast VLAN**

- Multicast VLAN:** Select Enable/Disable Multicast VLAN feature.
- VLAN ID:** Enter the VLAN ID of the multicast VLAN.
- Router Port Time:** Specify the aging time of the router port. Within this time, if the switch doesn't receive IGMP query message from the router port, it will consider this port is not a router port any more.
- Member Port Time:** Specify the aging time of the member port. Within this time, if the switch doesn't receive IGMP report message from the member port, it will consider this port is not a member port any more.
- Leave Time:** Specify the interval between the switch receiving a leave message from a host, and the switch removing the host from the multicast groups.
- Router Ports:** Select the static router port which is mainly used in the network with stable topology.



Note:

1. The router port should be in the multicast VLAN, otherwise the member ports can not receive multicast streams.
2. The Multicast VLAN won't take effect unless you first complete the configuration for the corresponding VLAN owning the port on the **802.1Q VLAN** page.
3. The link type of the member ports in the multicast VLAN can only be GENERAL.
4. Configure the link type of the router port in the multicast VLAN as TRUNK or configure the egress rule as TAG and the link type as GENERAL otherwise all the member ports in the multicast VLAN can not receive multicast streams.

5. After a multicast VLAN is created, all the IGMP packets will be processed only within the multicast VLAN.

Configuration procedure:

Step	Operation	Description
1	Enable IGMP Snooping function	Required. Enable IGMP Snooping globally on the switch and for the port on Multicast→IGMP Snooping→Snooping Config and Port Config page.
2	Create a multicast VLAN	Required. Create a multicast VLAN and add all the member ports and router ports to the VLAN on the VLAN→802.1Q VLAN page. <ul style="list-style-type: none"> • Configure the link type of the member ports as GENERAL. • Configure the link type of the router ports as TRUNK or configure the egress rule as tagged GENERAL.
3	Configure parameters for multicast VLAN	Optional. Enable and configure a multicast VLAN on the Multicast→IGMP Snooping→Multicast VLAN page. It is recommended to keep the default time parameters.
4	Look over the configuration	If it is successfully configured, the VLAN ID of the multicast VLAN will be displayed in the IGMP Snooping Status table on the Multicast→IGMP Snooping→Snooping Config page.

Application Example for Multicast VLAN:

➤ Network Requirements

Multicast source sends multicast streams via the router, and the streams are transmitted to user A and user B through the switch.

Router: Its WAN port is connected to the multicast source; its LAN port is connected to the switch. The multicast packets are transmitted in VLAN3.

Switch: Port 3 is connected to the router and the packets are transmitted in VLAN3; port 4 is connected to user A and the packets are transmitted in VLAN4; port 5 is connected to user B and the packets are transmitted in VLAN5.

User A: Connected to Port 4 of the switch.

User B: Connected to port 5 of the switch.

Configure a multicast VLAN, and user A and B receive multicast streams through the multicast VLAN.

➤ Network Diagram

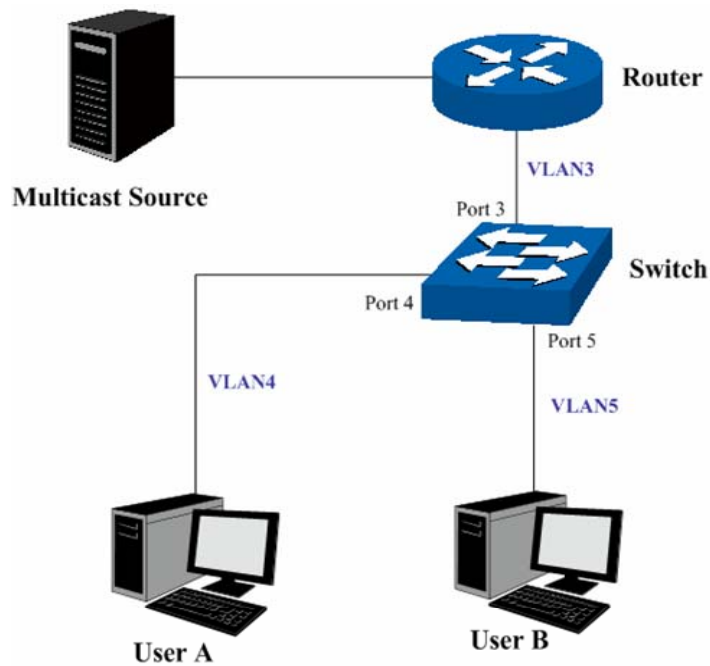

➤ Configuration Procedure

Step	Operation	Description
1	Create VLANs	Create three VLANs with the VLAN ID 3, 4 and 5 respectively, and specify the description of VLAN3 as Multicast VLAN on VLAN→802.1Q VLAN page.
2	Configure ports	On VLAN→802.1Q VLAN function pages. For port 3, configure its link type as GENERAL and its egress rule as TAG, and add it to VLAN3, VLAN4 and VLAN5. For port 4, configure its link type as GENERAL and its egress rule as UNTAG, and add it to VLAN3 and VLAN 4. For port 5, configure its link type as GENERAL and its egress rule as UNTAG, and add it to VLAN3 and VLAN 5.
3	Enable IGMP Snooping function	Enable IGMP Snooping function globally on Multicast→IGMP Snooping→Snooping Config page. Enable IGMP Snooping function for port 3, port4 and port 5 on Multicast→IGMP Snooping→Port Config page.
4	Enable Multicast VLAN	Enable Multicast VLAN, configure the VLAN ID of a multicast VLAN as 3 and keep the other parameters as default on Multicast→IGMP Snooping→Multicast VLAN page.
5	Check Multicast VLAN	3-5 and Multicast VLAN 3 will be displayed in the IGMP Snooping Status table on the Multicast→IGMP Snooping→Snooping Config page.

8.2 Multicast IP

In a network, receivers can join different multicast groups appropriate to their needs. The switch forwards multicast streams based on multicast address table. The Multicast IP can be implemented on **Multicast IP Table**, **Static Multicast IP** page.

8.2.1 Multicast IP Table

On this page you can view the multicast IP table on the switch.

Choose the menu **Multicast**→**Multicast IP**→**Multicast IP Table** to load the following page.

Search Option

Multicast IP: (Format: 225.0.0.1)

VLAN ID: (1-4094)

Port:

Type: All Static Dynamic

Multicast IP Table

Multicast IP	VLAN ID	Forward Port	Type
--------------	---------	--------------	------

Total Multicast IP: 0

Figure 8-8 Multicast IP Table

The following entries are displayed on this screen:

➤ **Search Option**

Multicast IP: Enter the multicast IP address the desired entry must carry.

VLAN ID: Enter the VLAN ID the desired entry must carry.

Port: Select the port number the desired entry must carry.

Type: Select the type the desired entry must carry.

- All: Displays all multicast IP entries.
- Static: Displays all static multicast IP entries.
- Dynamic: Displays all dynamic multicast IP entries.

➤ **Multicast IP Table**

Multicast IP Displays multicast IP address.

VLAN ID: Displays the VLAN ID of the multicast group.

Forward Port Displays the forward port of the multicast group.

Type: Displays the type of the multicast IP.



Note:

If the configuration on VLAN Config page and multicast VLAN page is changed, the switch will clear up the dynamic multicast addresses in multicast address table and learn new addresses.

8.2.2 Static Multicast IP

Static Multicast IP table, isolated from dynamic multicast group and multicast filter, is not learned by IGMP Snooping. It can enhance the quality and security for information transmission in some fixed multicast groups.

Choose the menu **Multicast**→**Multicast IP**→**Static Multicast IP** to load the following page.

Create Static Multicast

Multicast IP: (Format: 225.0.0.1)

VLAN ID: (1-4094)

Forward Port: (Format: 1-3,6,8)

Search Option

Search Option:

Static Multicast IP Table

Select	Multicast IP	VLAN ID	Forward Port
<input type="button" value="All"/> <input type="button" value="Delete"/> <input type="button" value="Help"/>			

Total Static Multicast IP: 0

Figure 8-9 Static Multicast IP Table

The following entries are displayed on this screen:

➤ **Create Static Multicast**

Multicast IP: Enter static multicast IP address.

VLAN ID: Enter the VLAN ID of the multicast IP.

Forward Port: Enter the forward port of the multicast group.

➤ **Search Option**

Search Option: Select the rules for displaying multicast IP table to find the desired entries quickly.

- All: Displays all static multicast IP entries.
- Multicast IP: Enter the multicast IP address the desired entry must carry.
- VLAN ID: Enter the VLAN ID the desired entry must carry.
- Port: Enter the port number the desired entry must carry.

➤ **Static Multicast IP Table**

Select: Select the desired entry to delete the corresponding static multicast IP. It is multi-optional.

Multicast IP: Displays the multicast IP.

VLAN ID: Displays the VLAN ID of the multicast group.

Forward Port: Displays the forward port of the multicast group.

8.3 Multicast Filter

When IGMP Snooping is enabled, you can specified the multicast IP-range the ports can join so as to restrict users ordering multicast programs via configuring multicast filter rules.

When applying for a multicast group, the host will send IGMP report message. After receiving the report message, the switch will firstly check the multicast filter rules configured for the receiving port. If the port can be added to the multicast group, it will be added to the multicast address table; if the port can not be added to the multicast group, the switch will drop the IGMP report message. In that way, the multicast streams will not be transmitted to this port, which allows you to control hosts joining the multicast group.

8.3.1 IP-Range

On this page you can figure the desired IP-ranges to be filtered.

Choose the menu **Multicast**→**Multicast Filter**→**IP-Range** to load the following page.

Create IP-Range

IP-Range ID: (1-30)

Start Multicast IP: (Format: 225.0.0.1)

End Multicast IP: (Format: 225.0.0.1)

IP-Range Table

	IP-Range ID	Start Multicast IP	End Multicast IP
<input type="checkbox"/>		<input type="text"/>	<input type="text"/>

Total IP-Range:0

Figure 8-10 Multicast Filter

The following entries are displayed on this screen:

➤ **Create IP-Range**

IP Range ID: Enter the IP-range ID.

Start Multicast IP: Enter start multicast IP of the IP-range you set.

End Multicast IP: Enter end multicast IP of the IP-range you set.

➤ **IP-Range Table**

IP-Range ID Select: Click the **Select** button to quick-select the corresponding IP-range ID based on the ID number you entered.

Select: Select the desired entry to delete or modify the corresponding IP-range. It is multi-optional.

IP-Range ID: Displays IP-range ID.

Start Multicast IP: Displays start multicast IP of the IP-range.

End Multicast IP: Displays end multicast IP of the IP-range.

8.3.2 Port Filter

On this page you can configure the multicast filter rules for port. Take the configuration on this page and the configuration on IP-Range page together to function to implement multicast filter function on the switch.

Choose the menu **Multicast**→**Multicast Filter**→**Port Filter** to load the following page.

Select	Port	Filter	Action Mode	Bound IP-Range (ID)	Max Groups	LAG
<input type="checkbox"/>		Disable	Permit			
<input type="checkbox"/>	1	Disable	permit	---	256	---
<input type="checkbox"/>	2	Disable	permit	---	256	---
<input type="checkbox"/>	3	Disable	permit	---	256	---
<input type="checkbox"/>	4	Disable	permit	---	256	---
<input type="checkbox"/>	5	Disable	permit	---	256	---
<input type="checkbox"/>	6	Disable	permit	---	256	---
<input type="checkbox"/>	7	Disable	permit	---	256	---
<input type="checkbox"/>	8	Disable	permit	---	256	---
<input type="checkbox"/>	9	Disable	permit	---	256	---
<input type="checkbox"/>	10	Disable	permit	---	256	---
<input type="checkbox"/>	11	Disable	permit	---	256	---
<input type="checkbox"/>	12	Disable	permit	---	256	---

Note:

1. The port filter configuration here has no effect on static multicast IP.
2. Up to 15 IP-Ranges can be bound to one port. Please input the Bound IP-Range (ID) in the format like: 1,5,8.

Figure 8-11 Port Filter

The following entries are displayed on this screen:

➤ **Port Filter Config**

- Port Select:** Click the **Select** button to quick-select the corresponding port based on the port number you entered.
- Select:** Select the desired port for multicast filtering. It is multi-optional.
- Port:** Displays the port number.
- Filter:** Select Enable/Disable multicast filtering feature on the port.
- Action Mode:** Select the action mode to process multicast packets when the multicast IP is in the filtering IP-range.
- Permit: Only the multicast packets whose multicast IP is in the IP-range will be processed.
 - Deny: Only the multicast packets whose multicast IP is not in the IP-range will be processed.
- Bound IP-Range (ID):** Enter the IP-rang ID the port will be bound to.
- Max Groups:** Specify the maximum number of multicast groups to prevent some ports taking up too much bandwidth.

LAG: Displays the LAG number which the port belongs to.

Note:

1. Multicast Filter feature can only have effect on the VLAN with IGMP Snooping enabled.
2. Multicast Filter feature has no effect on static multicast IP.
3. Up to 15 IP-Ranges can be bound to one port.

Configuration Procedure:

Step	Operation	Description
1	Configure IP-Range	Required. Configure IP-Range to be filtered on Multicast → Multicast Filter → IP-Range page.
2	Configure multicast filter rules for ports	Optional. Configure multicast filter rules for ports on Multicast → Multicast Filter → Port Filter page.

8.4 Packet Statistics

On this page you can view the multicast data traffic on each port of the switch, which facilitates you to monitor the IGMP messages in the network.

Choose the menu **Multicast**→**Packet Statistics** to load the following page.

Auto Refresh

Auto Refresh: Enable Disable Apply

Refresh Period: sec (3-300)

IGMP Statistics

Port Select

Port	Query Packet	Report Packet(V1)	Report Packet(V2)	Report Packet(V3)	Leave Packet	Error Packet
1	0	0	0	0	0	0
2	0	0	0	0	0	0
3	0	0	0	0	0	0
4	0	0	0	0	0	0
5	0	0	0	0	0	0
6	0	0	0	0	0	0
7	0	0	0	0	0	0
8	0	0	0	0	0	0
9	0	0	0	0	0	0
10	0	0	0	0	0	0
11	0	0	0	0	0	0
12	0	0	0	0	0	0

Refresh Clear Help

Figure 8-12 Packet Statistics

The following entries are displayed on this screen:

➤ **Auto Refresh**

Auto Refresh: Select Enable/Disable auto refresh feature.

Refresh Period: Enter the time from 3 to 300 in seconds to specify the auto refresh period.

➤ **IGMP Statistics**

Port Select: Click the **Select** button to quick-select the corresponding port based on the port number you entered.

Port: Displays the port number of the switch.

Query Packet: Displays the number of query packets the port received.

Report Packet (V1): Displays the number of IGMPv1 report packets the port received.

Report Packet (V2): Displays the number of IGMPv2 report packets the port received.

Report Packet (V3): Displays the number of IGMPv3 report packets the port received.

Leave Packet: Displays the number of leave packets the port received.

Error Packet: Displays the number of error packets the port received.

[Return to CONTENTS](#)

Chapter 9 QoS

QoS (Quality of Service) functions to provide different quality of service for various network applications and requirements and optimize the bandwidth resource distribution so as to provide a network service experience of a better quality.

➤ QoS

This switch classifies the ingress packets, maps the packets to different priority queues and then forwards the packets according to specified scheduling algorithms to implement QoS function.

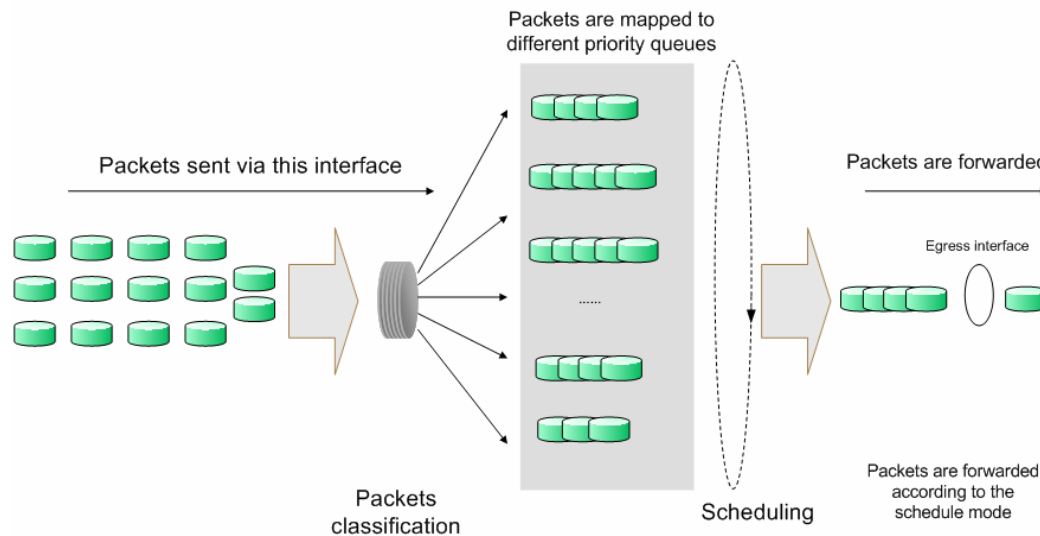

Figure 9-1 QoS function

- **Traffic classification:** Identifies packets conforming to certain characters according to certain rules.
- **Map:** The user can map the ingress packets to different priority queues based on the priority modes. This switch implements three priority modes based on port, on 802.1P and on DSCP.
- **Queue scheduling algorithm:** When the network is congested, the problem that many packets compete for resources must be solved, usually in the way of queue scheduling. The switch supports four schedule modes: SP, WRR, SP+WRR and Equ.

➤ Priority Mode

This switch implements three priority modes based on port, on 802.1P and on DSCP. By default, the priority mode based on port is enabled and the other two modes are optional.

1. Port Priority

Port priority is a priority level of the port. After port priority is configured, the data stream will be mapped to the egress queues directly according to the priority level of the port.

2. 802.1P Priority

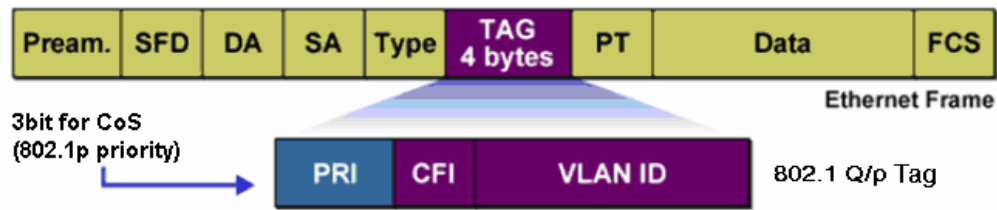

Figure 9-2 802.1Q frame

As shown in the figure above, each 802.1Q Tag has a Pri field, comprising 3 bits. The 3-bit priority field is 802.1p priority in the range of 0 to 7. 802.1P priority determines the priority of the packets based on the Pri value. On the Web management page of the switch, you can configure different priority tags mapping to the corresponding priority levels, and then the switch determine which packet is sent preferentially when forwarding packets. The switch processes untagged packets based on the default priority mode.

3. DSCP Priority

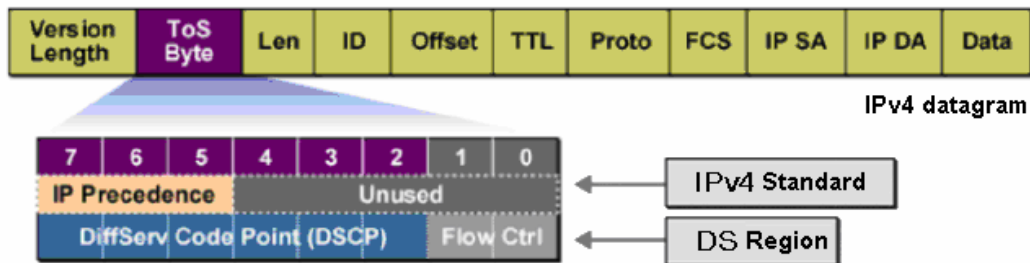

Figure 9-3 IP datagram

As shown in the figure above, the ToS (Type of Service) in an IP header contains 8 bits. The first three bits indicate IP precedence in the range of 0 to 7. RFC2474 re-defines the ToS field in the IP packet header, which is called the DS field. The first six bits (bit 0-bit 5) of the DS field indicate DSCP precedence in the range of 0 to 63. The last 2 bits (bit 6 and bit 7) are reserved. On the Web management page, you can configure different DS field mapping to the corresponding priority levels. Non-IP datagram with 802.1Q tag are mapped to different priority levels based on 802.1P priority mode if 802.1P Priority mode is enabled; the untagged non-IP datagram are mapped based on port priority mode.

➤ Schedule Mode

When the network is congested, the problem that many packets compete for resources must be solved, usually in the way of queue scheduling. The switch implements four scheduling queues, TC0, TC1, TC2 and TC3. TC0 has the lowest priority while TC3 has the highest priority. The switch provides four schedule modes: SP, WRR, SP+WRR and Equ.

1. SP-Mode: Strict-Priority Mode. In this mode, the queue with higher priority will occupy the whole bandwidth. Packets in the queue with lower priority are sent only when the queue with higher priority is empty. The switch has four egress queues labeled as TC0, TC1, TC2 and TC3. In SP mode, their priorities increase in order. TC3 has the highest priority. The disadvantage of SP queue is that: if there are packets in the queues with higher priority for a long time in congestion, the packets in the queues with lower priority will be “starved to death” because they are not served.

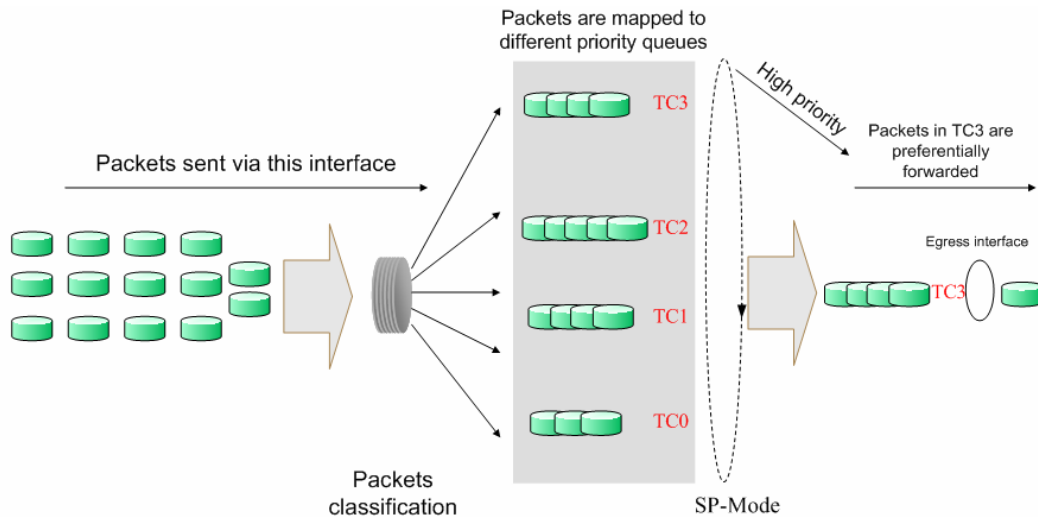

Figure 9-4 SP-Mode

2. **WRR-Mode: Weight Round Robin Mode.** In this mode, packets in all the queues are sent in order based on the weight value for each queue and every queue can be assured of a certain service time. The weight value indicates the occupied proportion of the resource. WRR queue overcomes the disadvantage of SP queue that the packets in the queues with lower priority can not get service for a long time. In WRR mode, though the queues are scheduled in order, the service time for each queue is not fixed, that is to say, if a queue is empty, the next queue will be scheduled. In this way, the bandwidth resources are made full use of. The default weight value ratio of TC0, TC1, TC2 and TC3 is 1:2:4:8.

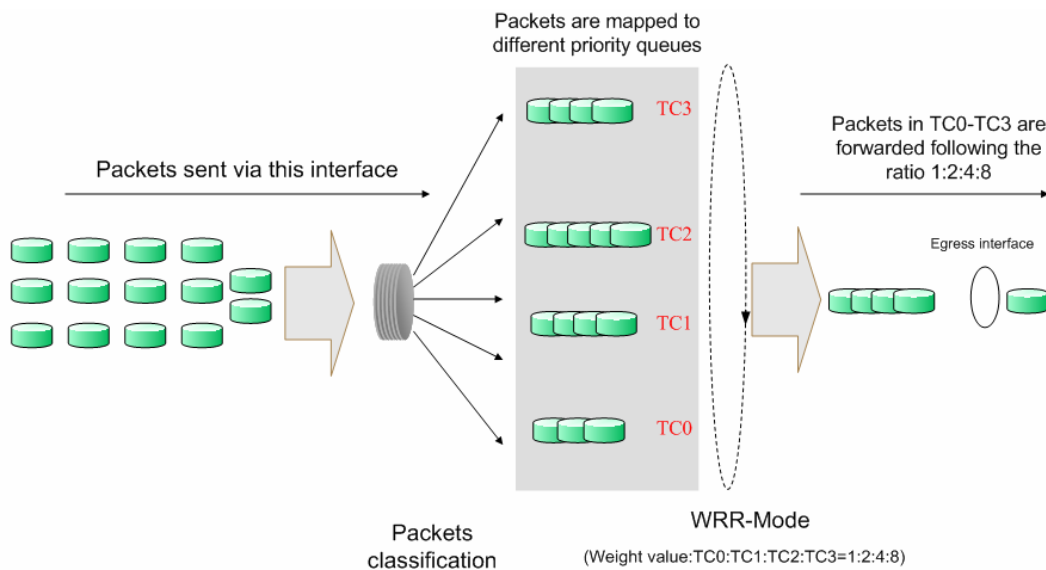

Figure 9-5 WRR-Mode

3. **SP+WRR-Mode: Strict-Priority + Weight Round Robin Mode.** In this mode, this switch provides two scheduling groups, SP group and WRR group. Queues in SP group and WRR group are scheduled strictly based on strict-priority mode while the queues inside WRR group follow the WRR mode. In SP+WRR mode, TC3 is in the SP group; TC0, TC1 and TC2 belong to the WRR group and the weight value ratio of TC0, TC1 and TC2 is 1:2:4. In this way, when scheduling queues, the switch allows TC3 to occupy the whole bandwidth following the SP mode and the TC0, TC1 and TC2 in the WRR group will take up the bandwidth according to their ratio 1:2:4.

4. Equ-Mode: Equal-Mode. In this mode, all the queues occupy the bandwidth equally. The weight value ratio of all the queues is 1:1:1:1.

The QoS module is mainly for traffic control and priority configuration, including two submenus: **DiffServ** and **Bandwidth Control**.

9.1 DiffServ

This switch classifies the ingress packets, maps the packets to different priority queues and then forwards the packets according to specified scheduling algorithms to implement QoS function.

This switch implements three priority modes based on port, on 802.1P and on DSCP, and supports four queue scheduling algorithms. The port priorities are labeled as TC0, TC1, TC2 and TC3.

The DiffServ function can be implemented on **Port Priority**, **802.1P Priority**, **DSCP Priority** and **Schedule Mode** pages.

9.1.1 Port Priority

On this page you can configure the port priority.

Choose the menu **QoS**→**DiffServ**→**Port Priority** to load the following page.

Port Priority Config			
Select	Port	Priority	LAG
<input type="checkbox"/>		TC 0	
<input type="checkbox"/>	1	TC 0	---
<input type="checkbox"/>	2	TC 0	---
<input type="checkbox"/>	3	TC 0	---
<input type="checkbox"/>	4	TC 0	---
<input type="checkbox"/>	5	TC 0	---
<input type="checkbox"/>	6	TC 0	---
<input type="checkbox"/>	7	TC 0	---
<input type="checkbox"/>	8	TC 0	---
<input type="checkbox"/>	9	TC 0	---
<input type="checkbox"/>	10	TC 0	---
<input type="checkbox"/>	11	TC 0	---
<input type="checkbox"/>	12	TC 0	---

note:

Among the Queue TC-id TC0,TC1...TC3, the bigger value,the higher priority.

Figure 9-6 Port Priority Config

The following entries are displayed on this screen:

➤ **Port Priority Config**

Select: Select the desired port to configure its priority. It is multi-optinal.

Port: Displays the physical port number of the switch.

- Priority:** Specify the priority for the port.
- LAG:** Displays the LAG number which the port belongs to.

 **Note:**

To complete QoS function configuration, you have to go to the **Schedule Mode** page to select a schedule mode after the configuration is finished on this page.

Configuration Procedure:

Step	Operation	Description
1	Log on to the Port Priority page	
2	Select the desired ports for configuration	Select the desired ports. It is multi-optional.
3	Select the port priority	Required. Select a priority from TC0 to TC3.
4	Select a schedule mode	Required. Log on to the Schedule Mode page to select a schedule mode.

9.1.2 802.1P Priority

On this page you can configure 802.1P priority. 802.1P gives the Pri field in 802.1Q tag a recommended definition. This field is used to divide packets into 8 priorities. When 802.1P Priority is enabled, the packets with 802.1Q tag are mapped to different priority levels based on 802.1P priority mode. The untagged packets are mapped based on port priority mode.

Choose the menu **QoS**→**DiffServ**→**802.1P Priority** to load the following page.

802.1P Priority Config

802.1P Priority: Enable Disable Apply

Priority and CoS-mapping Config

Tag-id/CoS-id: Queue TC-id:

Tag-id/CoS-id	Queue TC-id	Tag-id/CoS-id	Queue TC-id
0	TC1	1	TC0
2	TC0	3	TC1
4	TC2	5	TC2
6	TC3	7	TC3

Apply
Help

note:

Among the Queue TC-id TC0,TC1...TC3, the bigger value,the higher priority.

Figure 9-7 802.1P Priority

The following entries are displayed on this screen:

➤ **802.1P Priority Config**

802.1P Priority: Select Enable/Disable 802.1P Priority.

➤ **Priority Level**

Tag-id/CoS-id: Indicates the precedence level defined by IEEE802.1P and the CoS ID

Queue TC-id: Indicates the priority level of egress queue the packets with tag and CoS-id are mapped to. The priority levels of egress queue are labeled as TC0, TC1, TC2 and TC3



Note:

To complete QoS function configuration, you have to go to the **Schedule Mode** page to select a schedule mode after the configuration is finished on this page.

Configuration Procedure:

Step	Operation	Description
1	Log on to the 802.1P Priority page	
2	Enable 802.1P priority function	Required. By default, the 802.1P priority function is disabled.
3	Map the 802.1P priority tag to the priority level	Required. Select 802.1P priority tag and the corresponding priority level.
4	Select a schedule mode	Required. Log on to the Schedule Mode page to select a schedule mode.

9.1.3 DSCP Priority

On this page you can configure DSCP priority. DSCP (DiffServ Code Point) is a new definition to IP ToS field given by IEEE. This field is used to divide IP datagram into 64 priorities. When DSCP Priority is enabled, IP datagram are mapped to different priority levels based on DSCP priority mode; non-IP datagram with 802.1Q tag are mapped to different priority levels based on 802.1P priority mode if 802.1P Priority mode is enabled; the untagged non-IP datagram are mapped based on port priority mode.

Choose the menu **QoS**→**DiffServ**→**DSCP Priority** to load the following page.

DSCP Priority Config

DSCP Priority: Enable Disable Apply

Priority Level

DSCP: Priority Level:

DSCP	Priority Level	DSCP	Priority Level
0	TC0	1	TC0
2	TC0	3	TC0
4	TC0	5	TC0
6	TC0	7	TC0
8	TC0	9	TC0
10	TC0	11	TC0
12	TC0	13	TC0
14	TC0	15	TC0
16	TC1	17	TC1
18	TC1	19	TC1

Apply Help

note:

Among the priority levels TC0,TC1...TC3, the bigger value,the higher priority.

Figure 9-8 DSCP Priority

The following entries are displayed on this screen:

➤ **DSCP Priority Config**

DSCP Priority: Select Enable or Disable DSCP Priority.

➤ **Priority Level**

DSCP: Indicates the priority determined by the DS region of IP datagram. It ranges from 0 to 63.

Priority Level: Indicates the priority level the packets with tag are mapped to. The priority levels are labeled as TC0, TC1, TC2 and TC3.



Note:

To complete QoS function configuration, you have to go to the **Schedule Mode** page to select a schedule mode after the configuration is finished on this page.

Configuration procedure:

Step	Operation	Description
1	Log on to the DSCP Priority page	
2	Enable DP priority function	Required. By default, the DSCP priority function is disabled.
3	Map the DSCP priority to the priority level	Required. Select DSCP priority and the corresponding priority level.
4	Select a schedule mode	Required. Log on to the Schedule Mode page to select a schedule mode.

9.1.4 Schedule Mode

On this page you can select a schedule mode for the switch. When the network is congested, the problem that many packets compete for resources must be solved, usually in the way of queue scheduling. The switch will control the forwarding sequence of the packets according to the priority queues and scheduling algorithms you set. On this switch, the priority levels are labeled as TC0, TC1... TC3.

Choose the menu **QoS**→**DiffServ**→**Schedule Mode** to load the following page.



Schedule Mode Config

Schedule Mode: Equ-Mode

Apply

Help

Figure 9-9 Schedule Mode

The following entries are displayed on this screen:

➤ **Schedule Mode Config**

SP-Mode: Strict-Priority Mode. In this mode, the queue with higher priority will occupy the whole bandwidth. Packets in the queue with lower priority are sent only when the queue with higher priority is empty.

WRR-Mode: Weight Round Robin Mode. In this mode, packets in all the queues are sent in order based on the weight value for each queue. The weight value ratio of TC0, TC1, TC2 and TC3 is 1:2:4:8.

SP+WRR-Mode:

Strict-Priority + Weight Round Robin Mode. In this mode, this switch provides two scheduling groups, SP group and WRR group. Queues in SP group and WRR group are scheduled strictly based on strict-priority mode while the queues inside WRR group follow the WRR mode. In SP+WRR mode, TC3 is in the SP group; TC0, TC1 and TC2 belong to the WRR group and the weight value ratio of TC0, TC1 and TC2 is 1:2:4. In this way, when scheduling queues, the switch allows TC3 to occupy the whole bandwidth following the SP mode and the TC0, TC1 and TC2 in the WRR group will take up the bandwidth according to their ratio 1:2:4.

Equ-Mode:

Equal-Mode. In this mode, all the queues occupy the bandwidth equally. The weight value ratio of all the queues is 1:1:1:1.

9.2 Bandwidth Control

Bandwidth function, allowing you to control the traffic rate and broadcast flow on each port to ensure network in working order, can be implemented on **Rate Limit** and **Storm Control** pages.

9.2.1 Rate Limit

Rate limit functions to control the ingress/egress traffic rate on each port via configuring the available bandwidth of each port. In this way, the network bandwidth can be reasonably distributed and utilized.

Choose the menu **QoS**→**Bandwidth Control**→**Rate Limit** to load the following page.

Rate Limit Config

Port

Select	Port	Ingress Rate(Kbps)	Egress Rate(Kbps)	LAG
<input type="checkbox"/>		128	1024	
<input type="checkbox"/>	1	---	---	---
<input type="checkbox"/>	2	---	---	---
<input type="checkbox"/>	3	---	---	---
<input type="checkbox"/>	4	---	---	---
<input type="checkbox"/>	5	---	---	---
<input type="checkbox"/>	6	---	---	---
<input type="checkbox"/>	7	---	---	---
<input type="checkbox"/>	8	---	---	---
<input type="checkbox"/>	9	---	---	---
<input type="checkbox"/>	10	---	---	---
<input type="checkbox"/>	11	---	---	---
<input type="checkbox"/>	12	---	---	---

Note:

1. For one port, you cannot enable the Storm Control and the Ingress rate control at the same time.
2. If you select "Manual" to set Ingress/Egress rate, the system will automatically select integral multiple of 64Kbps that closest to the rate you entered as the real Ingress/Egress rate.

Figure 9-10 Rate Limit

The following entries are displayed on this screen:

➤ **Rate Limit Config**

- Port Select:** Click the **Select** button to quick-select the corresponding port based on the port number you entered.
- Select:** Select the desired port for Rate configuration. It is multi-optional.
- Port:** Displays the port number of the Switch.
- Ingress Rate(Kbps):** Configure the bandwidth for receiving packets on the port. You can select a rate from the dropdown list or select "Manual" to set Ingress rate, the system will automatically select integral multiple of 64Kbps that closest to the rate you entered as the real Ingress rate.
- Egress Rate(Kbps):** Configure the bandwidth for sending packets on the port. You can select a rate from the dropdown list or select "Manual" to set Egress rate, the system will automatically select integral multiple of 64Kbps that closest to the rate you entered as the real Egress rate.
- LAG:** Displays the LAG number which the port belongs to.

**Note:**

1. If you enable ingress rate limit feature for the storm control-enabled port, storm control feature will be disabled for this port.
2. When selecting "Manual" to set Ingress/Egress rate, the system will automatically select integral multiple of 64Kbps that closest to the rate you entered as the real Ingress/Egress rate. For example, if you enter 1023Kbps for egress rate, the system will automatically select 1024Kbps as the real Egress rate.
3. When egress rate limit feature is enabled for one or more ports, you are suggested to disable the flow control on each port to ensure the switch works normally.

9.2.2 Storm Control

Storm Control function allows the switch to filter broadcast, multicast and UL frame in the network. If the transmission rate of the three kind packets exceeds the set bandwidth, the packets will be automatically discarded to avoid network broadcast storm.

Choose the menu **QoS**→**Bandwidth Control**→**Storm Control** to load the following page.

Storm Control Config

Port

Select	Port	Broadcast Rate(bps)	Multicast Rate(bps)	UL-Frame Rate(bps)	LAG
<input type="checkbox"/>		128K <input type="button" value="v"/>	128K <input type="button" value="v"/>	128K <input type="button" value="v"/>	
<input type="checkbox"/>	1	---	---	---	---
<input type="checkbox"/>	2	---	---	---	---
<input type="checkbox"/>	3	---	---	---	---
<input type="checkbox"/>	4	---	---	---	---
<input type="checkbox"/>	5	---	---	---	---
<input type="checkbox"/>	6	---	---	---	---
<input type="checkbox"/>	7	---	---	---	---
<input type="checkbox"/>	8	---	---	---	---
<input type="checkbox"/>	9	---	---	---	---
<input type="checkbox"/>	10	---	---	---	---
<input type="checkbox"/>	11	---	---	---	---
<input type="checkbox"/>	12	---	---	---	---

Note:

For one port, you cannot enable the Storm Control and the Ingress rate control at the same time.

Figure 9-11 Storm Control

The following entries are displayed on this screen:

➤ **Storm Control Config**

Port Select:

Click the **Select** button to quick-select the corresponding port based on the port number you entered.

Select:	Select the desired port for Storm Control configuration. It is multi-optional.
Port:	Displays the port number of the Switch.
Broadcast Rate (bps):	Enable/Disable broadcast control feature for the port.
Multicast Rate (bps):	Enable/Disable multicast control feature for the port.
UL-Frame Rate (bps):	Enable/Disable UL-Frame control feature for the port.
LAG:	Displays the LAG number which the port belongs to.



Note:

If you enable storm control feature for the ingress rate limit-enabled port, ingress rate limit feature will be disabled for this port.

[Return to CONTENTS](#)

Chapter 10 SNMP

➤ SNMP Overview

SNMP (Simple Network Management Protocol) has gained the most extensive application on the UDP/IP networks. SNMP provides a management frame to monitor and maintain the network devices. It is used for automatically managing the various network devices no matter the physical differences of the devices. Currently, the most network management systems are based on SNMP.

SNMP is simply designed and convenient for use with no need of complex fulfillment procedures and too much network resources. With SNMP function enabled, network administrators can easily monitor the network performance, detect the malfunctions and configure the network devices. In the meantime, they can locate faults promptly and implement the fault diagnosis, capacity planning and report generating.

➤ SNMP Management Frame

SNMP management frame includes three network elements: SNMP Management Station, SNMP Agent and MIB (Management Information Base).

SNMP Management Station: SNMP Management Station is the workstation for running the SNMP client program, providing a friendly management interface for the administrator to manage the most network devices conveniently.

SNMP Agent: Agent is the server software operated on network devices with the responsibility of receiving and processing the request packets from SNMP Management Station. In the meanwhile, Agent will inform the SNMP Management Station of the events whenever the device status changes or the device encounters any abnormalities such as device reboot.

MIB: MIB is the set of the managed objects. MIB defines a few attributes of the managed objects, including the names, the access rights, and the data types. Every SNMP Agent has its own MIB. The SNMP Management station can read/write the MIB objects basing on its management right.

SNMP Management Station is the manager of SNMP network while SNMP Agent is the managed object. The information between SNMP Management Station and SNMP Agent are exchanged through SNMP (Simple Network Management Protocol). The relationship among SNMP Management Station, SNMP Agent and MIB is illustrated in the following figure.

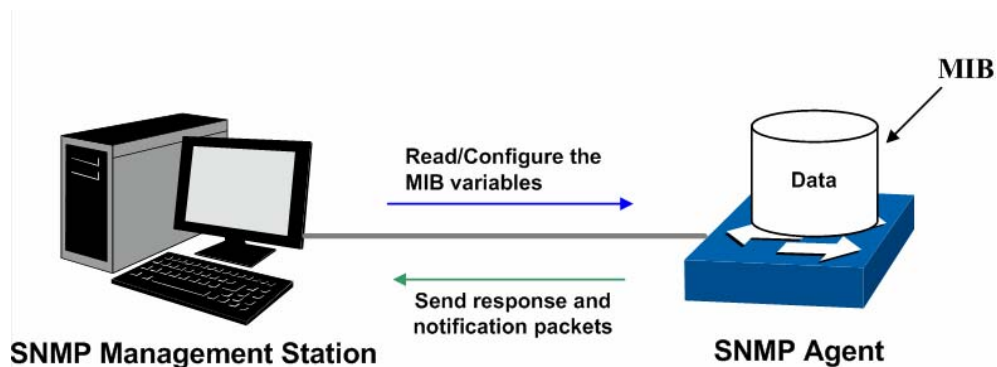

Figure 10-1 Relationship among SNMP Network Elements

➤ SNMP Versions

This switch supports SNMP v3, and is compatible with SNMP 1 and SNMP v2c. The SNMP versions adopted by SNMP Management Station and SNMP Agent should be the same. Otherwise, SNMP Management Station and SNMP Agent can not communicate with each other

normally. You can select the management mode with proper security level according to your actual application requirement.

SNMP v1: SNMP v1 adopts Community Name authentication. The community name is used to define the relation between SNMP Management Station and SNMP Agent. The SNMP packets that fail to pass community name authentication are discarded. The community name can limit access to SNMP Agent from SNMP NMS, functioning as a password.

SNMP v2c: SNMP v2c also adopts community name authentication. It is compatible with SNMP v1 while enlarges the function of SNMP v1.

SNMP v3: Basing on SNMP v1 and SNMP v2c, SNMP v3 extremely enhances the security and manageability. It adopts VACM (View-based Access Control Model) and USM (User-Based Security Model) authentication. The user can configure the authentication and the encryption functions. The authentication function is to limit the access of the illegal user by authenticating the senders of packets. Meanwhile, the encryption function is used to encrypt the packets transmitted between SNMP Management Station and SNMP Agent so as to prevent any information being stolen. The multiple combinations of authentication function and encryption function can guarantee a more reliable communication between SNMP Management station and SNMP Agent.

➤ MIB Introduction

To uniquely identify the management objects of the device in SNMP messages, SNMP adopts the hierarchical architecture to identify the managed objects. It is like a tree, and each tree node represents a managed object, as shown in the following figure. Thus the object can be identified with the unique path starting from the root and indicated by a string of numbers. The number string is the Object Identifier of the managed object. In the following figure, the OID of the managed object B is {1.2.1.1}. While the OID of the managed object A is {1.2.1.1.5}.

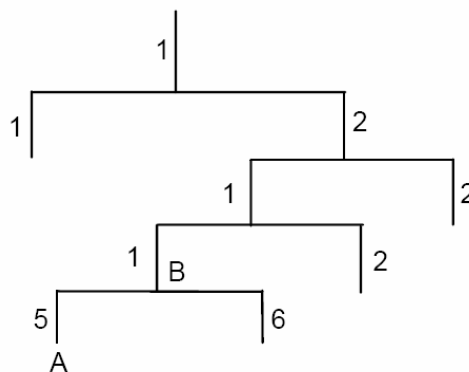

Figure 10-2 Architecture of the MIB tree

➤ SNMP Configuration Outline

1. Create View

The SNMP View is created for the SNMP Management Station to manage MIB objects. The managed object, uniquely identified by OID, can be set to under or out of the management of SNMP Management Station by configuring its view type (included/excluded). The OID of managed object can be found on the SNMP client program running on the SNMP Management Station.

2. Create SNMP Group

After creating the SNMP View, it's required to create a SNMP Group. The Group Name, Security Model and Security Level compose the identifier of the SNMP Group. The Groups with these three items the same are considered to be the same. You can configure SNMP Group to control the

network access by providing the users in various groups with different management rights via the Read View, Write View and Notify View.

3. Create SNMP User

The User configured in a SNMP Group can manage the switch via the client program on management station. The specified User Name and the Auth/Privacy Password are used for SNMP Management Station to access the SNMP Agent, functioning as the password.

SNMP module is used to configure the SNMP function of the switch, including three submenus: **SNMP Config**, **Notification** and **RMON**.

10.1 SNMP Config

The **SNMP Config** can be implemented on the **Global Config**, **SNMP View**, **SNMP Group**, **SNMP User** and **SNMP Community** pages.

10.1.1 Global Config

To enable SNMP function, please configure the SNMP function globally on this page.

Choose the menu **SNMP**→**SNMP Config**→**Global Config** to load the following page.

Global Config

SNMP: Enable Disable

Local Engine

Local Engine ID: (10-64 Hex)

Remote Engine

Remote Engine ID: (0 or 10-64 Hex)

Note:

The total hexadecimal characters of Engine ID should be even.

Figure 10-3 Global Config

The following entries are displayed on this screen:

➤ **Global Config**

SNMP: Enable/Disable the SNMP function.

➤ **Local Engine**

Local Engine ID: Specify the Switch's Engine ID for the remote clients. The Engine ID is a unique alphanumeric string used to identify the SNMP engine on the Switch.

➤ **Remote Engine**

Remote Engine ID: Specify the Remote Engine ID for Switch. The Engine ID is a unique alphanumeric string used to identify the SNMP engine on the remote device which receives informs from Switch.

 **Note:**
The amount of Engine ID characters must be even.

10.1.2 SNMP View

The OID (Object Identifier) of the SNMP packets is used to describe the managed objects of the switch, and the MIB (Management Information Base) is the set of the OIDs. The SNMP View is created for the SNMP management station to manage MIB objects.

Choose the menu **SNMP**→**SNMP Config**→**SNMP View** to load the following page.

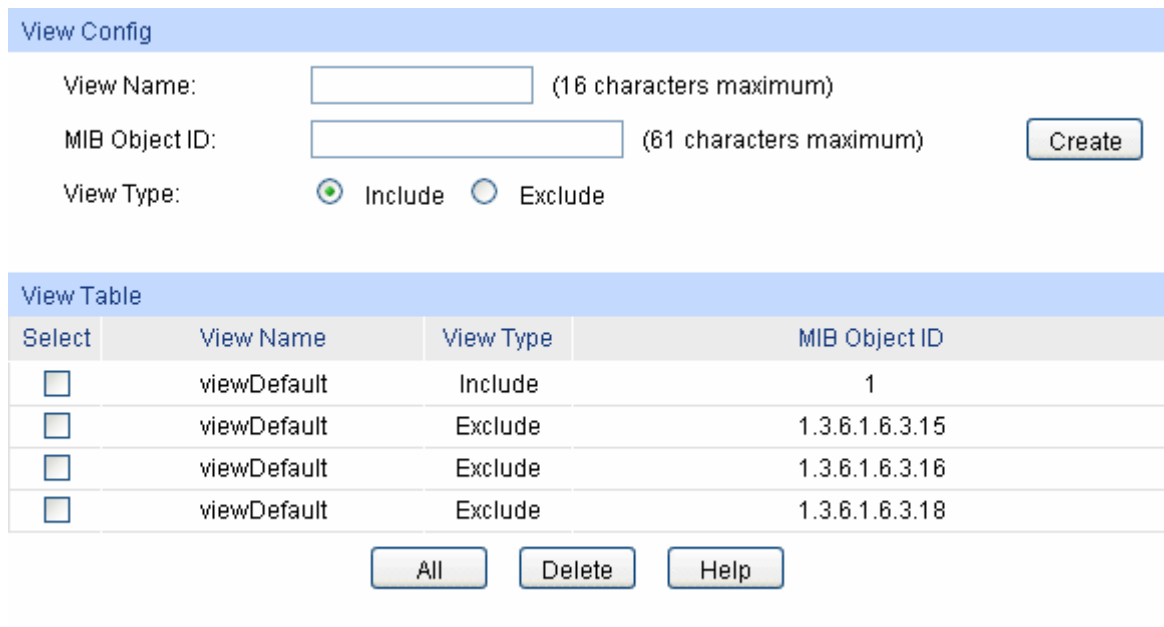

Select	View Name	View Type	MIB Object ID
<input type="checkbox"/>	viewDefault	Include	1
<input type="checkbox"/>	viewDefault	Exclude	1.3.6.1.6.3.15
<input type="checkbox"/>	viewDefault	Exclude	1.3.6.1.6.3.16
<input type="checkbox"/>	viewDefault	Exclude	1.3.6.1.6.3.18

Figure 10-4 SNMP View

The following entries are displayed on this screen:

➤ **View Config**

View Name: Give a name to the View for identification. Each View can include several entries with the same name.

MIB Object ID: Enter the Object Identifier (OID) for the entry of View.

View Type: Select the type for the view entry.

- Include: The view entry can be managed by the SNMP management station.
- Exclude: The view entry can not be managed by the SNMP management station.

➤ **View Table**

- Select:** Select the desired entry to delete the corresponding view. All the entries of a View will be deleted together.
- View Name:** Displays the name of the View entry.
- View Type:** Displays the type of the View entry.
- MIB Object ID:** Displays the OID of the View entry.

10.1.3 SNMP Group

On this page, you can configure SNMP Group to control the network access by providing the users in various groups with different management rights via the Read View, Write View and Notify View. Choose the menu **SNMP**→**SNMP Config**→**SNMP Group** to load the following page.

Group Config

Group Name: (16 characters maximum)

Security Model: v1

Security Level: noAuthNoPriv

Read View: viewDefault

Write View: None

Notify View: None

Group Table

Select	Group Name	Security Model	Security Level	Read View	Write View	Notify View	Operation
--------	------------	----------------	----------------	-----------	------------	-------------	-----------

Note:
A group should contain a read view, and the default read view is viewDefault.

Figure 10-5 SNMP Group

The following entries are displayed on this screen:

➤ **Group Config**

- Group Name:** Enter the SNMP Group name. The Group Name, Security Model and Security Level compose the identifier of the SNMP Group. These three items of the Users in one group should be the same.

Security Model: Select the Security Model for the SNMP Group.

- v1: SNMPv1 is defined for the group. In this model, the Community Name is used for authentication. SNMP v1 can be configured on the SNMP Community page directly.
- v2c: SNMPv2c is defined for the group. In this model, the Community Name is used for authentication. SNMP v2c can be configured on the SNMP Community page directly.
- v3: SNMPv3 is defined for the group. In this model, the USM mechanism is used for authentication. If SNMPv3 is enabled, the Security Level field is enabled for configuration.

Security Level: Select the Security Level for the SNMP v3 Group.

- noAuthNoPriv: No authentication and no privacy security level is used.
- authNoPriv: Only the authentication security level is used.
- authPriv: Both the authentication and the privacy security levels are used.

Read View: Select the View to be the Read View. The management access is restricted to read-only, and changes cannot be made to the assigned SNMP View.

Write View: Select the View to be the Write View. The management access is writing only and changes can be made to the assigned SNMP View. The View defined both as the Read View and the Write View can be read and modified.

Notify View: Select the View to be the Notify View. The management station can receive notification messages of the assigned SNMP view generated by the Switch's SNMP agent.

➤ **Group Table**

Select: Select the desired entry to delete the corresponding group. It's multi-optional.

Group Name: Displays the Group Name here.

Security Model: Displays the Security Model of the group.

Security Level: Displays the Security Level of the group.

Read View: Displays the Read View name in the entry.

Write View: Displays the Write View name in the entry.

Notify View: Displays the Notify View name in the entry.

Operation: Click the **Edit** button to modify the Views in the entry and click the **Modify** button to apply.



Note:

Every Group should contain a Read View. The default Read View is viewDefault.

10.1.4 SNMP User

The User in a SNMP Group can manage the switch via the management station software. The User and its Group have the same security level and access right. You can configure the SNMP User on this page.

Choose the menu **SNMP**→**SNMP Config**→**SNMP User** to load the following page.

User Config

User Name: (16 characters maximum)

User Type: Group Name:

Security Model: Security Level:

Auth Mode: Auth Password: (16 characters maximum)

Privacy Mode: Privacy Password: (16 characters maximum)

User Table

Select	User Name	User Type	Group Name	Security Model	Security Level	Auth Mode	Privacy Mode	Operation

Note:

The security model and security level of the user should be the same with that of its group.

Figure 10-6 SNMP User

The following entries are displayed on this screen:

➤ **User Config**

- User Name:** Enter the User Name here.
- User Type:** Select the type for the User.
- Local User: Indicates that the user is connected to a local SNMP engine.
 - Remote User: Indicates that the user is connected to a remote SNMP engine.
- Group Name:** Select the Group Name of the User. The User is classified to the corresponding Group according to its Group Name, Security Model and Security Level.
- Security Model:** Select the Security Model for the User.
- Security Level:** Select the Security Level for the SNMP v3 User.
- Auth Mode:** Select the Authentication Mode for the SNMP v3 User.
- None: No authentication method is used.
 - MD5: The port authentication is performed via HMAC-MD5 algorithm.
 - SHA: The port authentication is performed via SHA (Secure Hash Algorithm). This authentication mode has

a higher security than MD5 mode.

- Auth Password:** Enter the password for authentication.
- Privacy Mode:** Select the Privacy Mode for the SNMP v3 User.
- None: No privacy method is used.
 - DES: DES encryption method is used.
- Privacy Password:** Enter the Privacy Password.

➤ **User Table**

- Select:** Select the desired entry to delete the corresponding User. It is multi-optional.
- User Name:** Displays the name of the User.
- User Type:** Displays the User Type.
- Group Name:** Displays the Group Name of the User.
- Security Model:** Displays the Security Model of the User.
- Security Level:** Displays the Security Level of the User.
- Auth Mode:** Displays the Authentication Mode of the User.
- Privacy Mode:** Displays the Privacy Mode of the User.
- Operation:** Click the **Edit** button to modify the Group of the User and click the **Modify** button to apply.



Note:

The SNMP User and its Group should have the same Security Model and Security Level.

10.1.5 SNMP Community

SNMP v1 and SNMP v2c adopt community name authentication. The community name can limit access to the SNMP agent from SNMP network management station, functioning as a password. If SNMP v1 or SNMP v2c is employed, you can directly configure the SNMP Community on this page without configuring SNMP Group and User.

Choose the menu **SNMP**→**SNMP Config**→**SNMP Community** to load the following page.

Community Config

Community Name: (16 characters maximum)

Access:

MIB View:

Community Table

Select	Community Name	Access	MIB View	Operation
<input type="button" value="All"/>		<input type="button" value="Delete"/>		<input type="button" value="Help"/>

Note:

The default MIB view of community is viewDefault.

Figure 10-7 SNMP Community

The following entries are displayed on this screen:

➤ **Community Config**

- Community Name:** Enter the Community Name here.
- Access:** Defines the access rights of the community.
 - **read-only:** Management right of the Community is restricted to read-only, and changes cannot be made to the corresponding View.
 - **read-write:** Management right of the Community is read-write and changes can be made to the corresponding View.
- MIB View:** Select the MIB View for the community to access.

➤ **Community Table**

- Select:** Select the desired entry to delete the corresponding Community. It is multi-optional.
- Community Name:** Displays the Community Name here.
- Access:** Displays the right of the Community to access the View.
- MIB View:** Displays the Views which the Community can access.
- Operation:** Click the **Edit** button to modify the MIB View and the Access right of the Community, and then click the **Modify** button to apply.

Note:
The default MIB View of SNMP Community is viewDefault.

Configuration procedure:

- If SNMPv3 is employed, please take the following steps:

Step	Operation	Description
1	Enable SNMP function globally.	Required. On the SNMP→SNMP Config→Global Config page, enable SNMP function globally.
2	Create SNMP View.	Required. On the SNMP→SNMP Config→SNMP View page, create SNMP View of the management agent. The default View Name is viewDefault and the default OID is 1.
3	Create SNMP Group.	Required. On the SNMP→SNMP Config→SNMP Group page, create SNMP Group for SNMPv3 and specify SNMP Views with various access levels for SNMP Group.
4	Create SNMP User.	Required. On the SNMP→SNMP Config→SNMP User page, create SNMP User in the Group and configure the auth/privacy mode and auth/privacy password for the User.

- If SNMPv1 or SNMPv2c is employed, please take the following steps:

Step	Operation	Description		
1	Enable SNMP function globally.	Required. On the SNMP→SNMP Config→Global Config page, enable SNMP function globally.		
2	Create SNMP View.	Required. On the SNMP→SNMP Config→SNMP View page, create SNMP View of the management agent. The default View Name is viewDefault and the default OID is 1.		
3	<table border="1"> <tr> <td>Configure access level for the User.</td> <td> <p>Create SNMP Community directly.</p> <p>Create SNMP Group and SNMP User.</p> </td> </tr> </table>	Configure access level for the User.	<p>Create SNMP Community directly.</p> <p>Create SNMP Group and SNMP User.</p>	<p>Required alternatively.</p> <ul style="list-style-type: none"> • Create SNMP Community directly. On the SNMP→SNMP Config→SNMP Community page, create SNMP Community based on SNMP v1 and SNMP v2c. • Create SNMP Group and SNMP User. Similar to the configuration way based on SNMPv3, you can create SNMP Group and SNMP User of SNMP v1/v2c. The User name can limit access to the SNMP agent from SNMP network management station, functioning as a community name. The users can manage the device via the Read View, Write View and Notify View defined in the SNMP Group.
Configure access level for the User.	<p>Create SNMP Community directly.</p> <p>Create SNMP Group and SNMP User.</p>			

10.2 Notification

With the Notification function enabled, the switch can initiatively report to the management station about the important events that occur on the Views (e.g., the managed device is rebooted), which allows the management station to monitor and process the events in time.

The notification information includes the following two types:

Trap: Trap is the information that the managed device initiatively sends to the Network management station without request.

Inform: Inform packet is sent to inform the management station and ask for the reply. The switch will resend the inform request if it doesn't get the response from the management station during the Timeout interval, and it will terminate resending the inform request if the resending times reach the specified Retry times. The Inform type, employed on SNMPv2c and SNMPv3, has a higher security than the Trap type.

On this page, you can configure the notification function of SNMP.

Choose the menu **SNMP**→**Notification**→**Notification** to load the following page.

Create Notification

IP Address:	<input type="text"/>	UDP Port:	<input type="text" value="162"/>	
User:	<input type="text"/>			
Security Model:	<input type="text" value="v1"/>	Security Level:	<input type="text" value="noAuthNoPriv"/>	<input type="button" value="Create"/>
Type:	<input type="text" value="Trap"/>			<input type="button" value="Clear"/>
Retry:	<input type="text"/>	(1-255)		
Timeout:	<input type="text"/>	sec (1-3600)		

Notification Table

Select	IP Address	UDP Port	User	Security Model	Security Level	Type	Timeout	Retry	Operation
<input type="button" value="All"/> <input type="button" value="Delete"/> <input type="button" value="Help"/>									

Figure 10-8 Notification Config

The following entries are displayed on this screen:

➤ **Create Notification**

- IP Address:** Enter the IP Address of the management Host.
- UDP Port:** Enter the number of the UDP port used to send notifications. The UDP port functions with the IP address for the notification sending. The default is 162.
- User:** Enter the User name of the management station.
- Security Model:** Select the Security Model of the management station.
- Security Level:** Select the Security Level for the SNMP v3 User.
 - **noAuthNoPriv:** No authentication and no privacy security level are used.
 - **authNoPriv:** Only the authentication security level is used.
 - **authPriv:** Both the authentication and the privacy security levels are used.
- Type:** Select the type for the notifications.
 - **Trap:** Indicates traps are sent.
 - **Inform:** Indicates informs are sent. The Inform type has a

higher security than the Trap type.

Retry: Specify the amount of times the switch resends an inform request. The switch will resend the inform request if it doesn't get the response from the management station during the **Timeout** interval, and it will terminate resending the inform request if the resending times reach the specified **Retry** times.

Timeout: Specify the maximum time for the switch to wait for the response from the management station before resending a request.

➤ **Notification Table**

Select: Select the desired entry to delete the corresponding management station.

IP Address: Displays the IP Address of the management host.

UDP Port: Displays the UDP port used to send notifications.

User: Displays the User name of the management station.

Security Model: Displays the Security Model of the management station.

Security Level: Displays the Security Level for the SNMP v3 User.

Type: Displays the type of the notifications.

Timeout: Displays the maximum time for the switch to wait for the response from the management station before resending a request.

Retry: Displays the amount of times the switch resends an inform request.

Operation: Click the **Edit** button to modify the corresponding entry and click the **Modify** button to apply.

10.3 RMON

RMON (Remote Monitoring) basing on SNMP (Simple Network Management Protocol) architecture, functions to monitor the network. RMON is currently a commonly used network management standard defined by Internet Engineering Task Force (IETF), which is mainly used to monitor the data traffic across a network segment or even the entire network so as to enable the network administrator to take the protection measures in time to avoid any network malfunction. In addition, RMON MIB records network statistics information of network performance and malfunction periodically, based on which the management station can monitor network at any time effectively. RMON is helpful for network administrator to manage the large-scale network since it reduces the communication traffic between management station and managed agent.

➤ **RMON Group**

This switch supports the following four RMON Groups defined on the RMON standard (RFC1757): History Group, Event Group, Statistic Group and Alarm Group.

RMON Group	Function
History Group	After a history group is configured, the switch collects and records network statistics information periodically, based on which the management station can monitor network effectively.
Event Group	Event Group is used to define RMON events. Alarms occur when an event is detected.
Statistic Group	Statistic Group is set to monitor the statistic of alarm variables on the specific ports.
Alarm Group	Alarm Group is configured to monitor the specific alarm variables. When the value of a monitored variable exceeds the threshold, an alarm event is generated, which triggers the switch to act in the set way.

The **RMON** Groups can be configured on the **History Control**, **Event Config** and **Alarm Config** pages.

10.3.1 History Control

On this page, you can configure the History Group for RMON.

Choose the menu **SNMP**→**RMON**→**History Control** to load the following page.

History Control Table					
Select	Index	Port	Interval (sec)	Owner	Status
<input type="checkbox"/>		Port 1	<input type="text"/>	<input type="text"/>	Disable
<input type="checkbox"/>	1	Port 1	1800	monitor	Disable
<input type="checkbox"/>	2	Port 1	1800	monitor	Disable
<input type="checkbox"/>	3	Port 1	1800	monitor	Disable
<input type="checkbox"/>	4	Port 1	1800	monitor	Disable
<input type="checkbox"/>	5	Port 1	1800	monitor	Disable
<input type="checkbox"/>	6	Port 1	1800	monitor	Disable
<input type="checkbox"/>	7	Port 1	1800	monitor	Disable
<input type="checkbox"/>	8	Port 1	1800	monitor	Disable
<input type="checkbox"/>	9	Port 1	1800	monitor	Disable
<input type="checkbox"/>	10	Port 1	1800	monitor	Disable
<input type="checkbox"/>	11	Port 1	1800	monitor	Disable
<input type="checkbox"/>	12	Port 1	1800	monitor	Disable

Figure 10-9 History Control

The following entries are displayed on this screen:

➤ **History Control Table**

- Select:** Select the desired entry for configuration.
- Index:** Displays the index number of the entry.
- Port:** Specify the port from which the history samples were taken.
- Interval:** Specify the interval to take samplings from the port.

Owner: Enter the name of the device or user that defined the entry.

Status: Select Enable/Disable the corresponding sampling entry.

10.3.2 Event Config

On this page, you can configure the RMON events.

Choose the menu **SNMP**→**RMON**→**Event Config** to load the following page.

Select	Index	User	Description	Type	Owner	Status
<input type="checkbox"/>		<input type="text"/>	<input type="text"/>	None <input type="button" value="v"/>	<input type="text"/>	Disable <input type="button" value="v"/>
<input type="checkbox"/>	1	public		None	monitor	Disable
<input type="checkbox"/>	2	public		None	monitor	Disable
<input type="checkbox"/>	3	public		None	monitor	Disable
<input type="checkbox"/>	4	public		None	monitor	Disable
<input type="checkbox"/>	5	public		None	monitor	Disable
<input type="checkbox"/>	6	public		None	monitor	Disable
<input type="checkbox"/>	7	public		None	monitor	Disable
<input type="checkbox"/>	8	public		None	monitor	Disable
<input type="checkbox"/>	9	public		None	monitor	Disable
<input type="checkbox"/>	10	public		None	monitor	Disable
<input type="checkbox"/>	11	public		None	monitor	Disable
<input type="checkbox"/>	12	public		None	monitor	Disable

Figure 10-10 Event Config

The following entries are displayed on this screen:

➤ **Event Table**

Select: Select the desired entry for configuration.

Index: Displays the index number of the entry.

User: Enter the name of the User or the community to which the event belongs.

Description: Give a description to the event for identification.

Type: Select the event type, which determines the act way of the network device in response to an event.

- None: No processing.
- Log: Logging the event.
- Notify: Sending trap messages to the management station.
- Log&Notify: Logging the event and sending trap messages to the management station.

Owner: Enter the name of the device or user that defined the entry.

Status: Select Enable/Disable the corresponding event entry.

10.3.3 Alarm Config

On this page, you can configure Statistic Group and Alarm Group for RMON.

Choose the menu **SNMP**→**RMON**→**Alarm Config** to load the following page.

Select	Index	Variable	Port	Sample Type	Rising Threshold	Rising Event	Falling Threshold	Falling Event	Alarm Type	Interval (sec)	Owner	Status
<input type="checkbox"/>		DropEvents		Absolute					All			Disable
<input type="checkbox"/>	1	DropEvents	Port 1	Absolute	100	1	100	1	All	1800	monitor	Disable
<input type="checkbox"/>	2	DropEvents	Port 1	Absolute	100	1	100	1	All	1800	monitor	Disable
<input type="checkbox"/>	3	DropEvents	Port 1	Absolute	100	1	100	1	All	1800	monitor	Disable
<input type="checkbox"/>	4	DropEvents	Port 1	Absolute	100	1	100	1	All	1800	monitor	Disable
<input type="checkbox"/>	5	DropEvents	Port 1	Absolute	100	1	100	1	All	1800	monitor	Disable
<input type="checkbox"/>	6	DropEvents	Port 1	Absolute	100	1	100	1	All	1800	monitor	Disable
<input type="checkbox"/>	7	DropEvents	Port 1	Absolute	100	1	100	1	All	1800	monitor	Disable
<input type="checkbox"/>	8	DropEvents	Port 1	Absolute	100	1	100	1	All	1800	monitor	Disable
<input type="checkbox"/>	9	DropEvents	Port 1	Absolute	100	1	100	1	All	1800	monitor	Disable
<input type="checkbox"/>	10	DropEvents	Port 1	Absolute	100	1	100	1	All	1800	monitor	Disable
<input type="checkbox"/>	11	DropEvents	Port 1	Absolute	100	1	100	1	All	1800	monitor	Disable
<input type="checkbox"/>	12	DropEvents	Port 1	Absolute	100	1	100	1	All	1800	monitor	Disable

Figure 10-11 Alarm Config

The following entries are displayed on this screen:

➤ **Alarm Table**

- Select:** Select the desired entry for configuration.
- Index:** Displays the index number of the entry.
- Variable:** Select the alarm variables from the pull-down list.
- Port:** Select the port on which the Alarm entry acts.
- Sample Type:** Specify the sampling method for the selected variable and comparing the value against the thresholds.
 - **Absolute:** Compares the values directly with the thresholds at the end of the sampling interval.
 - **Delta:** Subtracts the last sampled value from the current value. The difference in the values is compared to the threshold.
- Rising Threshold:** Enter the rising counter value that triggers the Rising Threshold alarm.
- Rising Event:** Select the index of the corresponding event which will be triggered if the sampled value is larger than the Rising Threshold.
- Falling Threshold:** Enter the falling counter value that triggers the Falling Threshold alarm.
- Falling Event:** Select the index of the corresponding event which will be triggered if the sampled value is lower than the Falling Threshold.
- Alarm Type:** Specify the type of the alarm.

- **All:** The alarm event will be triggered either the sampled value exceeds the Rise Hold or is under the Fall Hold.
- **Rising:** When the sampled value exceeds the Rising Threshold, an alarm event is triggered.
- **Falling:** When the sampled value is under the Falling Threshold, an alarm event is triggered.

Interval:

Enter the alarm interval time in seconds.

Owner:

Enter the name of the device or user that defined the entry.

Status:

Select Enable/Disable the corresponding alarm entry.



Note:

When alarm variables exceed the Threshold on the same direction continuously for several times, an alarm event will only be generated on the first time, that is, the Rising Alarm and Falling Alarm are triggered alternately for that the alarm following to Rising Alarm is certainly a Falling Alarm and vice versa.

[Return to CONTENTS](#)

Chapter 11 Maintenance

Maintenance module, assembling the commonly used system tools to manage the switch, provides the convenient method to locate and solve the network problem.

- (1) System Monitor: Monitor the utilization status of the memory and the CPU of switch.
- (2) Log: View the configuration parameters of the switch and find out the errors via the Logs.
- (3) Cable Test: Test the connection status of the cable to locate and diagnose the trouble spot of the network.
- (4) Loopback: Test whether the ports of the switch and its peer device are available.
- (5) Network Diagnostics: Test whether the destination device is reachable and detect the route hops from the switch to the destination device.

11.1 System Monitor

System Monitor functions to display the utilization status of the memory and the CPU of switch via the data graph. The CPU utilization rate and the memory utilization rate should fluctuate stably around a specific value. If the CPU utilization rate or the memory utilization rate increases markedly, please detect whether the network is being attacked.

The **System Monitor** function is implemented on the **CPU Monitor** and **Memory Monitor** pages.

11.1.1 CPU Monitor

Choose the menu **Maintenance**→**System Monitor**→**CPU Monitor** to load the following page.

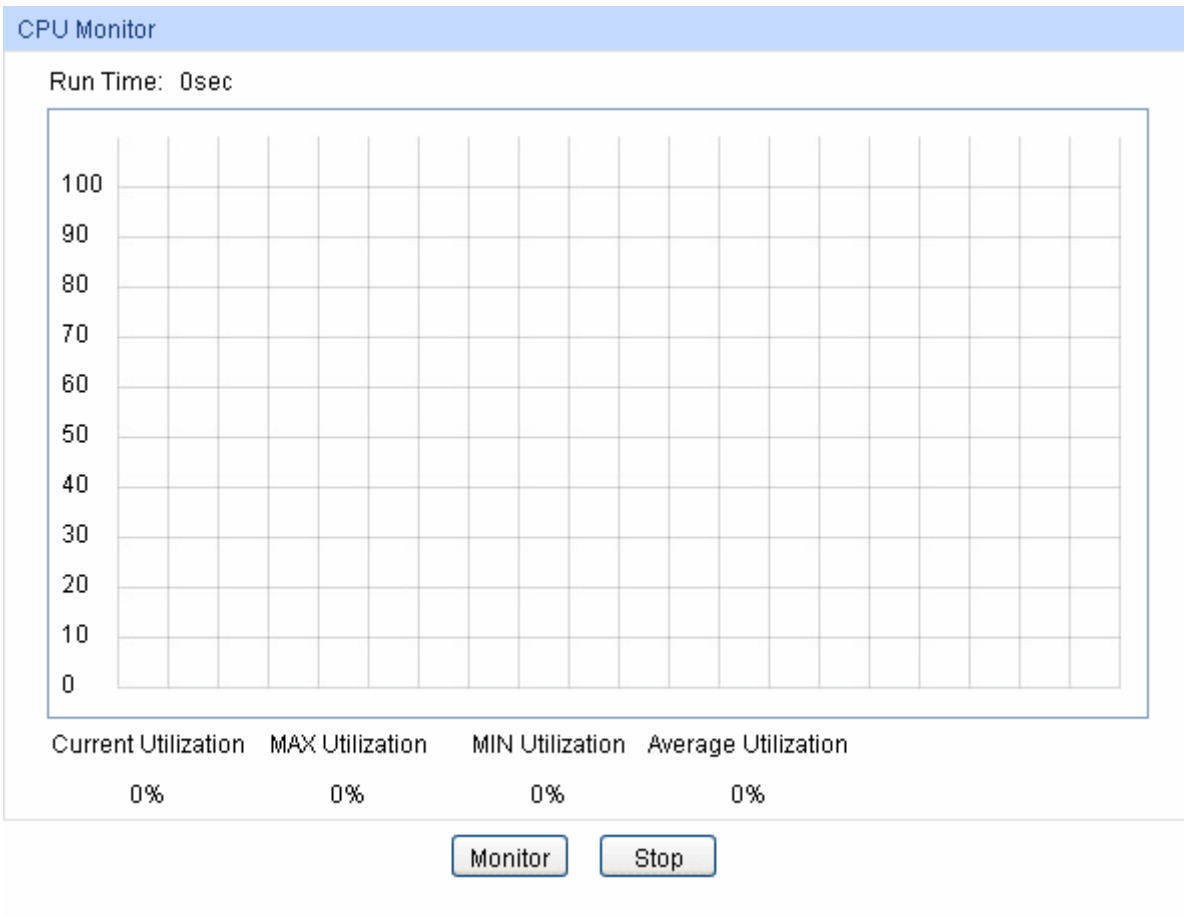

Figure 11-1 CPU Monitor

Click the **Monitor** button to enable the switch to monitor and display its CPU utilization rate every four seconds.

11.1.2 Memory Monitor

Choose the menu **Maintenance**→**System Monitor**→**Memory Monitor** to load the following page.

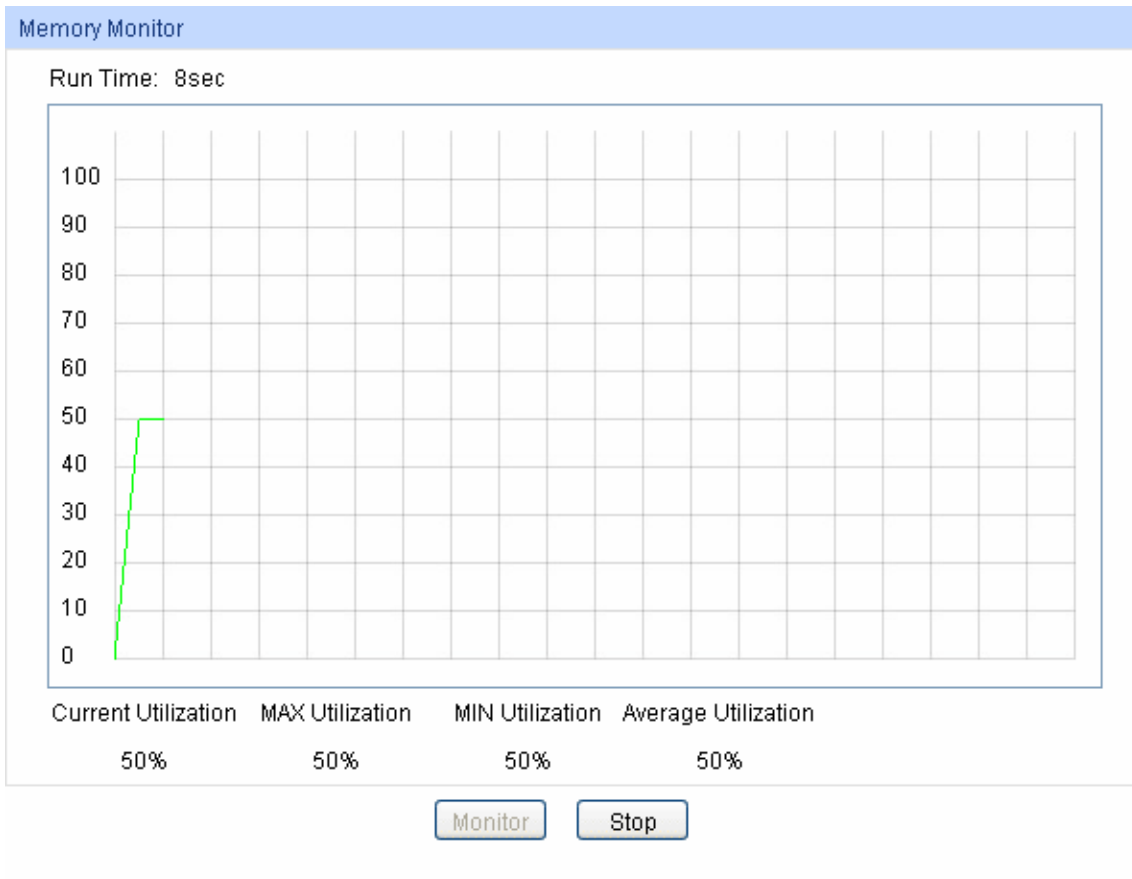

Figure 11-2 Memory Monitor

Click the **Monitor** button to enable the switch to monitor and display its Memory utilization rate every four seconds.

11.2 Log

The Log system of switch can record, classify and manage the system information effectively, providing powerful support for network administrator to monitor network operation and diagnose malfunction.

The Logs of switch are classified into the following eight levels.

Severity	Level	Description
emergencies	0	The system is unusable.
alerts	1	Action must be taken immediately.
critical	2	Critical conditions
errors	3	Error conditions
warnings	4	Warnings conditions
notifications	5	Normal but significant conditions
informational	6	Informational messages
debugging	7	Debug-level messages

Table 11-1 Log Level

The **Log** function is implemented on the **Log Table**, **Local Log**, **Remote Log** and **Backup Log** pages.

11.2.1 Log Table

The switch supports logs output to two directions, namely, log buffer and log file. The information in log buffer will be lost after the switch is rebooted or powered off whereas the information in log file will be kept effective even the switch is rebooted or powered off. Log Table displays the system log information in log buffer.

Choose the menu **Maintenance**→**Log**→**Log Table** to load the following page.

Log Info				
Index	Time	Module	Severity	Content
		All Module ▾	All Level ▾	
1	2010-01-25 16:17:19	SNTP	level_5	Getting time from administer PC OK.
2	2006-01-01 08:43:51	SNTP	level_5	Getting time from administer PC failed.
3	2006-01-01 08:00:04	LACP	level_5	LACP registering OK.
4	2006-01-01 08:00:01	GVRP	level_5	GVRP module initialization OK.
5	2006-01-01 08:00:00	QoS	level_5	QoS module initialization OK.

Note:

1. There are 8 severity levels marked with value 0-7. The smaller value has the higher priority.
2. This page displays logs in the log buffer, and at most 512 logs are displayed.

Figure 11-3 Log Table

The following entries are displayed on this screen:

➤ **Log Info**

- Index:** Displays the index of the log information.
- Time:** Displays the time when the log event occurs. The log can get the correct time after you configure on the System ->System Info->System Time Web management page.
- Module:** Displays the module which the log information belongs to. You can select a module from the drop-down list to display the corresponding log information.
- Severity:** Displays the severity level of the log information. You can select a severity level to display the log information whose severity level value is the same or smaller.
- Content:** Displays the content of the log information.



Note:

1. The logs are classified into eight levels based on severity. The higher the information severity is, the lower the corresponding level is.
2. This page displays logs in the log buffer, and at most 512 logs are displayed.

11.2.2 Local Log

Local Log is the log information saved in switch. By default, all system logs are saved in log buffer and the logs with severities from level_0 to level_4 are saved in log file meanwhile. On this page, you can set the output channel for logs.

Choose the menu **Maintenance**→**Log**→**Local Log** to load the following page.

Local Log Config			
Select	Channel	Severity	Status
<input type="checkbox"/>		<input type="text" value=""/>	<input type="text" value=""/>
<input type="checkbox"/>	Log Buffer	level_7	Enable
<input type="checkbox"/>	Log File	level_4	Enable

Note:

1. Local log includes 2 channels: log buffer and log file.
2. There are 8 severity levels marked with values 0-7. The smaller value has the higher priority.

Figure 11-4 Local Log

The following entries are displayed on this screen:

➤ **Local Log Config**

- Select:** Select the desired entry to configure the corresponding local log.
- Log Buffer:** Indicates the RAM for saving system log. The information in the log buffer is displayed on the Log Table page. It will be lost when the switch is restarted.
- Log File:** Indicates the flash sector for saving system log. The information in the log file will not be lost after the switch is restarted and can be exported on the Backup Log page.
- Severity:** Specify the severity level of the log information output to each channel. Only the log with the same or smaller severity level value will be output.
- Status:** Enable/Disable the channel.

11.2.3 Remote Log

Remote log feature enables the switch to send system logs to the Log Server. Log Server is to centralize the system logs from various devices for the administrator to monitor and manage the whole network.

Choose the menu **Maintenance**→**Log**→**Remote Log** to load the following page.

Log Host					
Select	Index	Host IP	UDP Port	Severity	Status
<input type="checkbox"/>		<input type="text"/>		<input type="text" value="level_6"/>	<input type="text" value="Disable"/>
<input type="checkbox"/>	1	0.0.0.0	514	level_6	Disable
<input type="checkbox"/>	2	0.0.0.0	514	level_6	Disable
<input type="checkbox"/>	3	0.0.0.0	514	level_6	Disable
<input type="checkbox"/>	4	0.0.0.0	514	level_6	Disable

Note:

- 1.Up to 4 log hosts are supported.
- 2.There are 8 severity levels marked with values 0-7. The smaller value has the higher priority.

Figure 11-5 Log Host

The following entries are displayed on this screen:

➤ **Log Host**

- Index:** Displays the index of the log host. The switch supports 4 log hosts.
- Host IP:** Configure the IP for the log host.
- UDP Port:** Displays the UDP port used for receiving/sending log information. Here we use the standard port 514.
- Severity:** Specify the severity level of the log information sent to each log host. Only the log with the same or smaller severity level value will be sent to the corresponding log host.
- Status:** Enable/Disable the log host.



Note:

The Log Server software is not provided. If necessary, please download it on the Internet.

11.2.4 Backup Log

Backup Log feature enables the system logs saved in the switch to be output as a file for device diagnosis and statistics analysis. When a critical error results in the breakdown of the system, you can export the logs to get some related important information about the error for device diagnostics after the switch is restarted.

Choose the menu **Maintenance**→**Log**→**Backup Log** to load the following page.

Backup Log

Click the button here to backup the log file:

Note:

It will take a few minutes to backup the log file. Please wait without any operation.

Figure 11-6 Backup Log

The following entry is displayed on this screen:

> Backup Log

Backup Log: Click the **Backup Log** button to save the log as a file to your computer.



Note:

It will take a few minutes to backup the log file. Please wait without any operation.

11.3 Device Diagnostics

This switch provides Cable Test and Loopback functions for device diagnostics.

11.3.1 Cable Test

Cable Test functions to test the connection status of the cable connected to the switch, which facilitates you to locate and diagnose the trouble spot of the network.

Choose the menu **Maintenance**→**Device Diagnostics**→**Cable Test** to load the following page.

Cable Test			
Port:	--		Unit: meter
Pair	Status	Length	Error
Pair-A	--	--	--
Pair-B	--	--	--
Pair-C	--	--	--
Pair-D	--	--	--

Note:

1. The interval between two cable test for one port must be more than 3 seconds.
2. The result is more reasonable when the cable pair is in the open status.
3. The result is just for your information.
4. If the port is 100M and its connection status is normal, cable test can't get the length of the cable.

Figure 11-7 Cable Test

The following entries are displayed on this screen:

> Cable Test

Port: Select the port for cable testing.

- Pair:** Displays the Pair number.
- Status:** Displays the connection status of the cable connected to the port. The test results of the cable include normal, close, open, short, impedance or unknown.
- Length:** If the connection status is normal, here displays the length range of the cable.
- Error:** If the connection status is close, open or impedance, here displays the error length of the cable.

 **Note:**

1. The Length displayed here is the length of pair cable not that of the physical cable.
2. The test result is just for your reference.

11.3.2 Loopback

Loopback test function, looping the sender and the receiver of the signal, is used to test whether the port of the switch is available as well as to check and analyze the physical connection status of the port to help you locate and solve network malfunctions.

Choose the menu **Maintenance**→**Device Diagnostics**→**Loopback** to load the following page.

Loopback Type

Loopback Type: Internal External

Loopback Port

<input type="checkbox"/> 1	<input type="checkbox"/> 2	<input type="checkbox"/> 3	<input type="checkbox"/> 4	<input type="checkbox"/> 5	<input type="checkbox"/> 6
<input type="checkbox"/> 7	<input type="checkbox"/> 8	<input type="checkbox"/> 9	<input type="checkbox"/> 10	<input type="checkbox"/> 11	<input type="checkbox"/> 12
<input type="checkbox"/> 13	<input type="checkbox"/> 14	<input type="checkbox"/> 15	<input type="checkbox"/> 16	<input type="checkbox"/> 17	<input type="checkbox"/> 18
<input type="checkbox"/> 19	<input type="checkbox"/> 20	<input type="checkbox"/> 21	<input type="checkbox"/> 22	<input type="checkbox"/> 23	<input type="checkbox"/> 24
<input type="checkbox"/> 25	<input type="checkbox"/> 26	<input type="checkbox"/> 27	<input type="checkbox"/> 28		

Loopback Result

Port:N/A
Type:N/A
Result:N/A

Figure 11-8 Loopback

The following entries are displayed on this screen:

➤ **Loopback Type**

Internal: Select Internal to test whether the port is available.

External: Select External to test whether the device connected to the port of the switch is available

➤ **Loopback Port**

Loopback Port: Select the desired port for loopback test.

Test: Click the **Test** button to start the loopback test for the port.

11.4 Network Diagnostics

This switch provides Ping test and Tracert test functions for network diagnostics.

11.4.1 Ping

Ping test function, testing the connectivity between the switch and one node of the network, facilitates you to test the network connectivity and reachability of the host so as to locate the network malfunctions.

Choose the menu **Maintenance**→**Network Diagnostics**→**Ping** to load the following page.

Ping Config

Destination IP:

Ping Times: (1-10)

Data Size: byte (1-1024)

Interval: millisec (100-1000)

Ping Result

Pinging 192.168.0.1 with 64 bytes of data :

Reply from 192.168.0.1 : bytes=64 time<16ms TTL=64
Reply from 192.168.0.1 : bytes=64 time<16ms TTL=64
Reply from 192.168.0.1 : bytes=64 time<16ms TTL=64
Reply from 192.168.0.1 : bytes=64 time<16ms TTL=64

Ping statistics for 192.168.0.1:

Packets: Sent = 4 , Received = 4 , Lost = 0 (0% loss)

Approximate round trip times in milli-seconds:

Minimum = 0ms , Maximum = 0ms , Average = 0ms

Figure 11-9 Ping

The following entries are displayed on this screen:

➤ **Ping Config**

Destination IP: Enter the IP address of the destination node for Ping test.

Ping Times: Enter the amount of times to send test data during Ping testing. The default value is recommended.

Data Size: Enter the size of the sending data during Ping testing. The default

value is recommended.

Interval: Specify the interval to send ICMP request packets. The default value is recommended.

11.4.2 Tracert

Tracert test function is used to test the connectivity of the gateways during its journey from the source to destination of the test data. When malfunctions occur to the network, you can locate trouble spot of the network with this tracert test.

Choose the menu **Maintenance**→**Network Diagnostics**→**Tracert** to load the following page.

Tracert Config

Destination IP:

Max Hop: hop (1-30)

Tracert Result

Figure 11-10Tracert

The following entries are displayed on this screen:

➤ **Tracert Config**

Destination IP: Enter the IP address of the destination device.

Max Hop: Specify the maximum number of the route hops the test data can pass through.

[Return to CONTENTS](#)

Appendix A: Specifications

Standards	IEEE802.3 10Base-T Ethernet
	IEEE802.3u 100Base-TX/100Base-FX Fast Ethernet
	IEEE802.3ab 1000Base-T Gigabit Ethernet
	IEEE802.3z 1000Base-X Gigabit Ethernet
	IEEE802.3x Flow Control
	IEEE802.1p Priority
	IEEE802.1q VLAN Bridge
	IEEE802.1d Spanning Tree
	IEEE802.1s Multiple Spanning Tree
	IEEE802.1w Rapid Spanning Tree Protocol
Transmission Rate	Ethernet: 10Mbps HD, 20Mbps FD
	Fast Ethernet: 100Mbps HD, 200Mbps FD
	Gigabit Ethernet: 2000Mbps FD
Transmission Medium	10Base-T: UTP/STP of Cat. 3 or above
	100Base-TX: UTP/STP of Cat. 5 or above
	100Base-FX: MMF or SMF SFP Module (Optional)
	1000Base-T: 4-pair UTP ($\leq 100\text{m}$) of Cat. 5, Cat. 5e, Cat. 6
	1000Base-X: MMF or SMF SFP Module (Optional)
LED	Power, System, 10/100M LEDs, 1000M LEDs
Transmission Method	Store and Forward
Packets Forwarding Rate	10BASE-T: 14881pps/port 100BASE-TX: 148810pps/port 1000Base-T: 1488095pps/port
Operating Environment	Operating Temperature: 0°C ~ 40°C
	Storage Temperature: -40°C ~ 70°C
	Operating Humidity: 10% ~ 90% RH Non-condensing
	Storage Humidity: 5% ~ 90% RH Non-condensing

[Return to CONTENTS](#)

Appendix B: Configuring the PCs

In this section, we'll introduce how to install and configure the TCP/IP correctly in Windows 2000. First make sure your Ethernet Adapter is working, refer to the adapter's manual if necessary.

1. Configure TCP/IP component

- 1) On the Windows taskbar, click the **Start** button, and then click **Control Panel**.
- 2) Click the **Network and Internet Connections** icon, and then click on the **Network Connections** tab in the appearing window.
- 3) Right click the icon that showed below, select Properties on the prompt page.

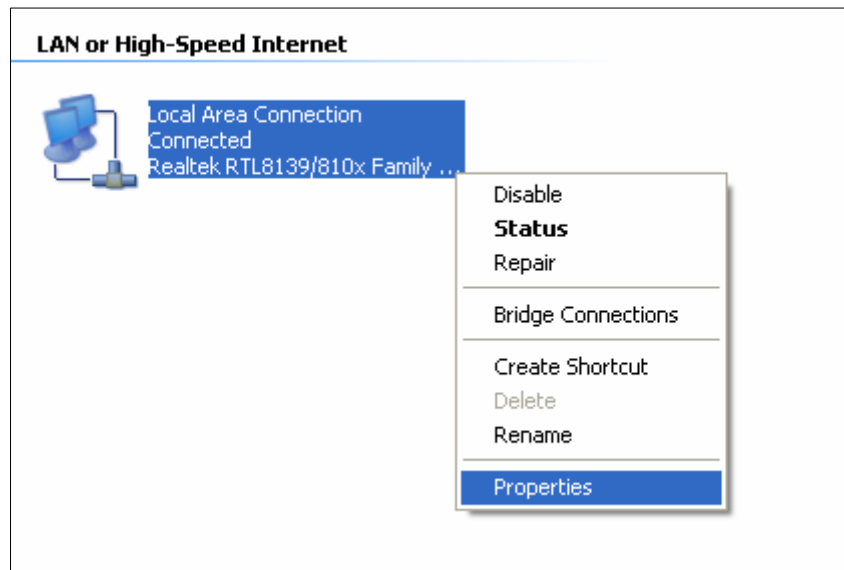

Figure B-1

- 4) In the prompt page that showed below, double click on the **Internet Protocol (TCP/IP)**.

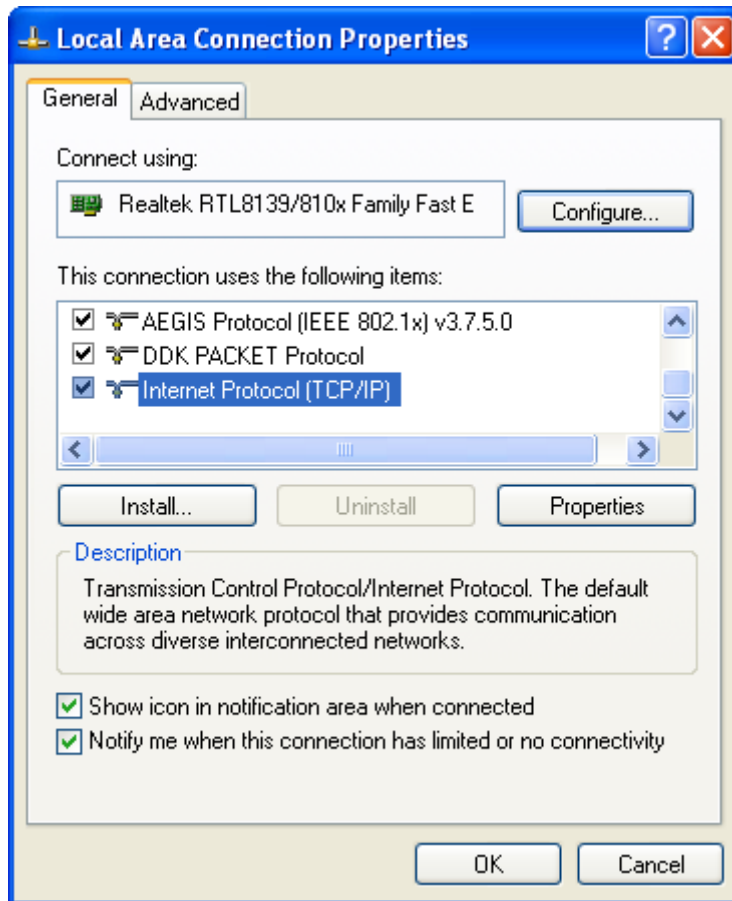

Figure B-2

- 5) The following **TCP/IP Properties** window will display and the **IP Address** tab is open on this window by default.

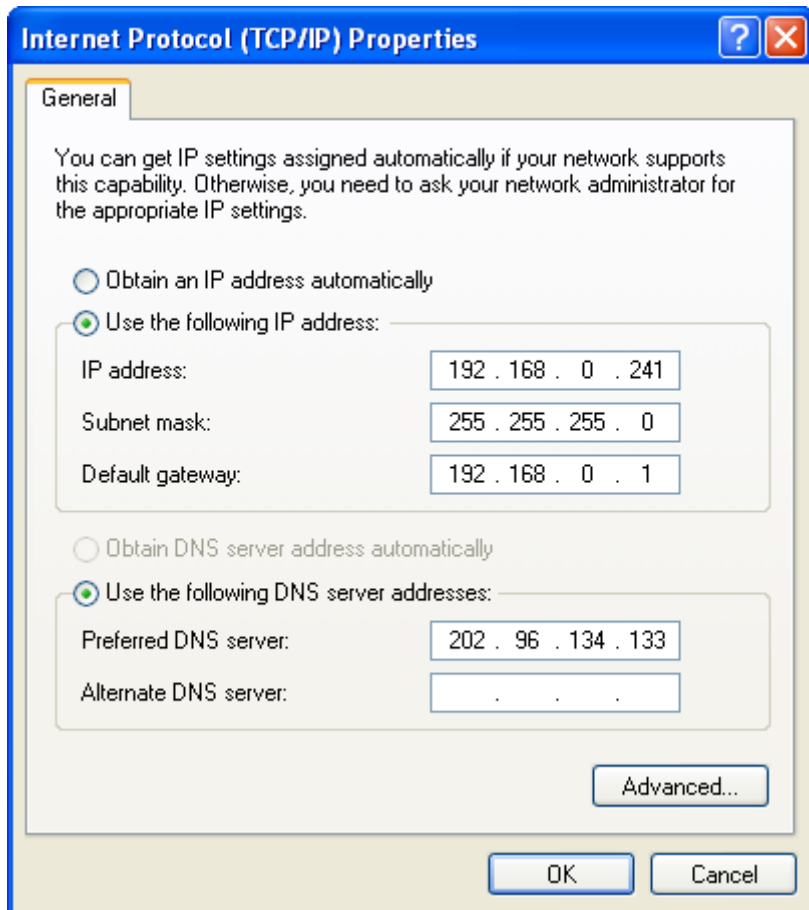

Figure B-3

- 6) Select **Use the following IP address**. And the following items will be available. If the switch's IP address is 192.168.0.1, specify IP address as 192.168.0.x (x is from 2 to 254), and the **Subnet mask** as 255.255.255.0.

Now:

Click **OK** to save your settings.

[Return to CONTENTS](#)

Appendix C: Glossary

Access Control List (ACL)

ACLs can limit network traffic and restrict access to certain users or devices by checking each packet for certain IP or MAC (i.e., Layer 2) information.

Boot Protocol (BOOTP)

BOOTP is used to provide bootup information for network devices, including IP address information, the address of the TFTP server that contains the devices system files, and the name of the boot file.

Class of Service (CoS)

CoS is supported by prioritizing packets based on the required level of service, and then placing them in the appropriate output queue. Data is transmitted from the queues using weighted round-robin service to enforce priority service and prevent blockage of lower-level queues. Priority may be set according to the port default, the packet's priority bit (in the VLAN tag), TCP/UDP port number, or DSCP priority bit.

Differentiated Services Code Point (DSCP)

DSCP uses a six-bit tag to provide for up to 64 different forwarding behaviors. Based on network policies, different kinds of traffic can be marked for different kinds of forwarding. The DSCP bits are mapped to the Class of Service categories, and then into the output queues.

Domain Name Service (DNS)

A system used for translating host names for network nodes into IP addresses.

Dynamic Host Control Protocol (DHCP)

Provides a framework for passing configuration information to hosts on a TCP/IP network. DHCP is based on the Bootstrap Protocol (BOOTP), adding the capability of automatic allocation of reusable network addresses and additional configuration options.

Extensible Authentication Protocol over LAN (EAPOL)

EAPOL is a client authentication protocol used by this switch to verify the network access rights for any device that is plugged into the switch. A user name and password is requested by the switch, and then passed to an authentication server (e.g., RADIUS) for verification. EAPOL is implemented as part of the IEEE 802.1X Port Authentication standard.

GARP VLAN Registration Protocol (GVRP)

Defines a way for switches to exchange VLAN information in order to register necessary VLAN members on ports along the Spanning Tree so that VLANs defined in each switch can work automatically over a Spanning Tree network.

Generic Attribute Registration Protocol (GARP)

The GARP provides a generic attribute dissemination capability that is used by participants in GARP Applications (GARP Participants) to register and de-register attribute values with other GARP Participants within a Bridged LAN. The definition of the attribute types, the values that they can carry, and the semantics that are associated with those values when registered, are specific to the operation of the GARP Application concerned.

Generic Multicast Registration Protocol (GMRP)

GMRP allows network devices to register end stations with multicast groups. GMRP requires that any participating network devices or end stations comply with the IEEE 802.1p standard.

Group Attribute Registration Protocol (GARP)

See Generic Attribute Registration Protocol.

IEEE 802.1D

Specifies a general method for the operation of MAC bridges, including the Spanning Tree Protocol.

IEEE 802.1Q

VLAN Tagging—Defines Ethernet frame tags which carry VLAN information. It allows switches to assign endstations to different virtual LANs, and defines a standard way for VLANs to communicate across switched networks.

IEEE 802.1p

An IEEE standard for providing quality of service (QoS) in Ethernet networks. The standard uses packet tags that define up to eight traffic classes and allows switches to transmit packets based on the tagged priority value.

IEEE 802.1X

Port Authentication controls access to the switch ports by requiring users to first enter a user ID and password for authentication.

IEEE 802.3ac

Defines frame extensions for VLAN tagging.

IEEE 802.3x

Defines Ethernet frame start/stop requests and timers used for flow control on full-duplex links. (Now incorporated in IEEE 802.3-2002)

Internet Group Management Protocol (IGMP)

A protocol through which hosts can register with their local router for multicast services. If there is more than one multicast switch/router on a given subnetwork, one of the devices is made the “querier” and assumes responsibility for keeping track of group membership.

IGMP Snooping

Listening to IGMP Query and IGMP Report packets transferred between IP Multicast Routers and IP Multicast host groups to identify IP Multicast group members.

IGMP Query

On each subnetwork, one IGMP-capable device will act as the querier — that is, the device that asks all hosts to report on the IP multicast groups they wish to join or to which they already belong. The elected querier will be the device with the lowest IP address in the subnetwork.

IP Multicast Filtering

It is a feature to allow or deny the Client to add the specified multicast group.

Multicast Switching

A process whereby the switch filters incoming multicast frames for services which no attached host has registered, or forwards them to all ports contained within the designated multicast group.

Layer 2

Data Link layer in the ISO 7-Layer Data Communications Protocol. This is related directly to the hardware interface for network devices and passes on traffic based on MAC addresses.

Link Aggregation

See Port Trunk.

Link Aggregation Control Protocol (LACP)

Allows ports to automatically negotiate a trunked link with LACP-configured ports on another device.

Management Information Base (MIB)

An acronym for Management Information Base. It is a set of database objects that contains information about a specific device.

MD5 Message-Digest Algorithm

An algorithm that is used to create digital signatures. It is intended for use with 32 bit machines and is safer than the MD4 algorithm, which has been broken. MD5 is a one-way hash function, meaning that it takes a message and converts it into a fixed string of digits, also called a message digest.

Network Time Protocol (NTP)

NTP provides the mechanisms to synchronize time across the network. The time servers operate in a hierarchical-master-slave configuration in order to synchronize local clocks within the subnet and to national time standards via wire or radio.

Port Authentication

See *IEEE 802.1X*.

Port Mirroring

A method whereby data on a target port is mirrored to a monitor port for troubleshooting with a logic analyzer or RMON probe. This allows data on the target port to be studied unobstructively.

Port Trunk

Defines a network link aggregation and trunking method which specifies how to create a single high-speed logical link that combines several lower-speed physical links.

Remote Authentication Dial-in User Service (RADIUS)

RADIUS is a logon authentication protocol that uses software running on a central server to control access to RADIUS-compliant devices on the network.

Remote Monitoring (RMON)

RMON provides comprehensive network monitoring capabilities. It eliminates the polling required in standard SNMP, and can set alarms on a variety of traffic conditions, including specific error types.

Rapid Spanning Tree Protocol (RSTP)

RSTP reduces the convergence time for network topology changes to about 10% of that required by the older IEEE 802.1D STP standard.

Secure Shell (SSH)

A secure replacement for remote access functions, including Telnet. SSH can authenticate users with a cryptographic key, and encrypt data connections between management clients and the switch.

Simple Network Management Protocol (SNMP)

The application protocol in the Internet suite of protocols which offers network management services.

Simple Network Time Protocol (SNTP)

SNTP allows a device to set its internal clock based on periodic updates from a Network Time Protocol (NTP) server. Updates can be requested from a specific NTP server, or can be received via broadcasts sent by NTP servers.

Spanning Tree Algorithm (STA)

A technology that checks your network for any loops. A loop can often occur in complicated or backup linked network systems. Spanning Tree detects and directs data along the shortest available path, maximizing the performance and efficiency of the network.

Telnet

Defines a remote communication facility for interfacing to a terminal device over TCP/IP.

Transmission Control Protocol/Internet Protocol (TCP/IP)

Protocol suite that includes TCP as the primary transport protocol, and IP as the network layer protocol.

Trivial File Transfer Protocol (TFTP)

A TCP/IP protocol commonly used for software downloads.

User Datagram Protocol (UDP)

UDP provides a datagram mode for packet-switched communications. It uses IP as the underlying transport mechanism to provide access to IP-like services. UDP packets are delivered just like IP packets – connection-less datagrams that may be discarded before reaching their targets. UDP is useful when TCP would be too complex, too slow, or just unnecessary.

Virtual LAN (VLAN)

A Virtual LAN is a collection of network nodes that share the same collision domain regardless of their physical location or connection point in the network. A VLAN serves as a logical workgroup with no physical barriers, and allows users to share information and resources as though located on the same LAN.

[Return to CONTENTS](#)