

InFocus

Projector

IN5132/IN5132c/IN5142/IN5142c/IN5134/ IN5134c/IN5144/IN5144c/IN5135/ IN5135c/IN5145/IN5145c

User's Manual (concise)

Please read this user's manual thoroughly to ensure the proper use of this product.

Manuel d'utilisation (résumé)

Nous vous recommandons de lire attentivement ce manuel pour bien assimiler le fonctionnement de l'appareil.

Bedienungsanleitung (Kurzform)

Um zu gewährleisten, dass Sie die Bedienung des Geräts verstanden haben, lesen Sie dieses Handbuch bitte sorgfältig.

Manual de usuario (resumen)

Lea atentamente el manual de usuario del proyector para garantizar un uso adecuado del mismo.

Manuale d'istruzioni (breve)

Vi preghiamo di leggere attentamente il manuale d'istruzioni per garantire una corretta comprensione delle istruzioni.

Brukerhåndbok (konsis)

Vennligst les denne brukerhåndbok grundig for å være garantert driftssikker bruk.

Gebruiksaanwijzing (beknopt)

Lees deze gebruikershandleiding grondig door, zodat u de werking ervan begrijpt en correct gebruik verzekerd is.

Instruções do proprietário (concisas)

Leia atentamente o presente manual do utilizador para garantir a utilização correcta por via da sua compreensão.

使用说明书 (简易版)

请仔细阅读本《使用说明书》，在理解的基础上正确使用。

사용 설명서 (휴대용)

본 사용자 설명서를 잘 읽으시고 이해하신 후, 올바르게 사용해 주십시오.

Bruksanvisning (koncis)

Läs denna bruksanvisning noga för att förstå alla instruktionerna för ett korrekt bruk.

Руководство пользователя (краткое)

Пожалуйста, внимательно прочтите данное руководство пользователя для ознакомления и правильного использования.

Käyttäjän ohjekirja (suppea)

Lue käyttäjän ohjekirja huolellisesti varmistaaksesi, että ymmärrät miten laitetta käytetään oikein.

Podręcznik użytkownika (skrótowy)

Przeczytaj dokładnie i ze zrozumieniem niniejszy podręcznik użytkownika, aby zapewnić prawidłowe użytkowanie urządzenia.

Panduan Pengguna (singkat)

Mohon dibaca panduan ini secara cermat untuk menjamin produk ini digunakan dengan benar.

دليل المستخدم (الموجز)

يرجى قراءة دليل المستخدم بعناية لضمان الاستخدام الأمثل لهذا المنتج.

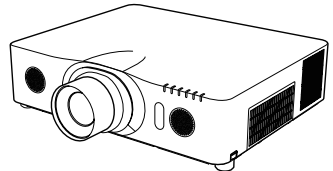

ENGLISH

FRANÇAIS

DEUTSCH

ESPAÑOL

ITALIANO

NORSK

NEDERLANDS

PORTUGUÊS

中文

한국어

SVENSKA

РУССКИЙ

SUOMI

POLSKI

INDO BAHASA

العربية

NOTE • The information in this manual is subject to change without notice. • The manufacturer assumes no responsibility for any errors that may appear in this manual. • The reproduction, transfer or copy of all or any part of this document is not permitted without express written consent.

REMARQUE • Les informations contenues dans ce manuel peuvent faire l'objet de changements sans avertissement préalable. • Le fabricant ne prend aucune responsabilité pour les erreurs qui pourraient se trouver dans ce manuel. • La reproduction, la transmission ou l'utilisation de ce document ou de son contenu est interdite sauf autorisation spéciale écrite.

HINWEIS • Die Informationen in diesem Handbuch können ohne vorherige Ankündigung geändert werden. • Der Hersteller übernimmt keine Verantwortung für etwaige in diesem Handbuch enthaltene Fehler. • Die Vervielfältigung, Übertragung oder Verwendung dieses Dokuments oder dessen Inhalts ist ohne ausdrückliche schriftliche Genehmigung nicht gestattet.

NOTA • La información de este manual puede sufrir modificaciones sin previo aviso. • El fabricante no asume ninguna responsabilidad por los errores que puedan aparecer en este manual. • No está permitida la reproducción, transmisión o utilización de este documento ni de su contenido sin autorización expresa por escrito.

NOTA • Le informazioni riportate in questo manuale sono soggette a modifica senza preavviso. • Il produttore declina qualsiasi responsabilità per eventuali errori che potrebbero comparire nel presente manuale. • E' vietata la riproduzione, la trasmissione o l'utilizzo del presente documento o del suo contenuto senza espressa autorizzazione scritta.

MERK • Informasjonen i denne håndboken kan endres uten varsel. • Produsenten påtar seg intet ansvar for eventuelle feil som fremkommer i denne håndboken. • Reproduksjon, overføring eller bruk av dette dokumentet eller deler av det, er ikke tillatt uten uttrykt skriftlig tillatelse.

OPMERKING • De informatie in deze handleiding kan zonder voorafgaande kennisgeving veranderd worden. • De fabrikant neemt geen enkele verantwoordelijkheid voor de eventuele fouten in deze handleiding. • Reproductie, overdracht of het gebruik van dit document is niet toegestaan, zonder uitdrukkelijke toestemming van de betreffende partij.

NOTA • As informações contidas neste manual estão sujeitas a alterações sem aviso prévio. • O fabricante não se responsabiliza por quaisquer erros que possam surgir neste manual. • A reprodução, transmissão ou utilização deste documento ou do seu conteúdo não é permitida sem autorização expressa por escrito.

通知事項 • 本书中刊载的内容有可能不经预告而发生变更。• 本产品的制造者对本书中的刊载错误不负任何责任。• 未经允许请勿复制、转载和使用本书的部分或全部内容。

알림 • 본서에 기재되어 있는 내용은 예고 없이 변경하는 일이 있습니다. • 본제품의 제조자는, 본서에 있어서의 기재 오류에 대해서 일절의 책임도 지지 않습니다. • 본서 내용의 일부 혹은 전부를 무단으로 복사하거나 전제하여 사용하는 것을 절대 금합니다.

NOTERA • Informationen i denna bruksanvisning kan komma att ändras utan förvarning. • Tillverkaren påtar sig inget ansvar för eventuella fel i denna bruksanvisning. • Återgivning, översändande eller användning av detta dokument eller dess innehåll är inte tillåten utan uttrycklig skriftligt medgivande.

ПРИМЕЧАНИЕ. • Содержание данного руководства может изменяться без предварительного уведомления. • Производитель не несет ответственности за ошибки в данном руководстве. • Воспроизведение, передача и использование данного документа или его содержания запрещено без письменного разрешения.

HUOM! • Tämän ohjekirjan tiedot voivat muuttua ilman eri ilmoitusta. • Valmistaja ei ota mitään vastuuta ohjekirjassa mahdollisesti olevista virheistä. • Dokumentin tai sen sisällön jäljentäminen, siirto tai käyttö ei ole sallittua ilmannimenomaista kirjallista valtuutusta.

UWAGA • Informacje podane w tym podręczniku mogą ulec zmianie bez uprzedzenia. • Producent nie ponosi odpowiedzialności za ewentualne błędy w podręczniku. • Powielanie, przesyłanie lub inne wykorzystanie tego dokumentu lub jego treści nie jest dozwolone bez wyraźnej pisemnej zgody.

CATATAN • Informasi dalam panduan ini tunduk pada perubahan tanpa adanya pemberitahuan. • Pabrik tidak bertanggung jawab atas kesalahan apa pun yang mungkin timbul dalam panduan ini. • Dilarang memperbanyak, menyalin atau menyebarkan seluruh atau sebagian dokumen ini tanpa adanya persetujuan tertulis.

ملاحظة • المعلومات الواردة بهذا الدليل عرضة للتغيير دون إخطار. • لا تتحمل الجهة المصنعة مسؤولية الأخطاء التي قد تظهر بهذا الدليل. • لا يجوز إعادة إنتاج أي جزء من هذه الوثيقة أو نقلها أو نسخها دون الحصول على موافقة كتابية بذلك.

Projector

IN5132/IN5142/IN5134/IN5144/ IN5135/IN5145

User's Manual (concise)

Thank you for purchasing this projector.

Before using this projector, please read through this manual in order to use it safely.

⚠ WARNING ▶ Before using this product, read all manuals for this product. Afterwards, store the manuals in a safe place for future reference.
▶ Heed all warnings and cautions in the manuals and displayed on the product.
▶ Follow all the instructions in the manuals and on the product.

NOTE • In this manual, unless any comments are accompanied, “the manuals” means all the documents provided with this product, and “the product” means this projector and all the accessories came with the projector.

Contents

Safety Information 2	Turning on the power..... 9
Symbols and headings explanation.....2	Adjusting the projector's elevator 10
Important safety instruction2	Adjusting the lens position..... 10
Regulatory notices..... 3	Displaying the picture 11
About Electro-Magnetic Interference3	Turning off the power..... 12
About Waste Electrical and Electronic Equipment...4	Replacing the lamp..... 13
Contents of package..... 4	Cleaning and replacing the air filter .. 15
Preparing for the remote control..... 5	Specifications 17
Arrangement..... 6	Troubleshooting
Connecting with your devices..... 7	- Warranty and after-service 19
Fastening the adapter cover..... 8	End User License Agreement for the
Connecting power supply 8	Projector Software 20

Safety Information

Symbol and headings explanation

The following symbols and headings are used for the manuals and the product as follows, for safety purposes. Please review and read this important information.

⚠ **WARNING** This warns of a serious risk of personal injury or even death.

⚠ **CAUTION** This warns of a risk of personal injury or physical damage.

NOTICE This warns of a potential for causing problems.

Important safety instructions

The following instructions are designed to ensure the safe use of this product. Always follow these instructions when handling the product. The manufacturer assumes no responsibility for any damage caused by mishandling that is beyond normal usage defined in these projector manuals.

⚠ **WARNING** ▶ Never use the product during or after an abnormal situation (for example, when the projector is smoking, smells strange, had a liquid spilled on it, had an object put inside it, is broken, etc.). If an abnormality should occur, unplug the projector immediately.

▶ Keep the product away from children and pets.

▶ Keep small parts away from children and pets. If parts are swallowed, consult a physician immediately for emergency treatment.

▶ Do not use the product when there is a threat of thunder and lightning.

▶ Unplug the projector from the power outlet when it is not in use.

▶ Do not connect the projector to a power supply when a lens unit is not attached to it.

▶ Do not open or remove any portion of the product, unless the manuals direct you so. Internal maintenance should only be accomplished by your dealer or their service personnel.

▶ Use only the accessories specified or recommended by the manufacturer.

▶ Do not modify the projector or accessories.

▶ Do not let any liquid or objects get inside of the product.

▶ Do not get the product wet.

▶ Do not place the projector where any oils, such as cooking or machine oil, are used. Oil may harm the product, resulting in a malfunction, or falling from mounted position.

▶ Do not apply a shock or pressure to this product.

- Do not place the product on an unstable place such as an uneven surface or a leaning table.

- Do not place the product in an unstable position. Place the projector so that it does not protrude from the surface which it is placed on.

- Hold the projector using the grips on the bottom of the projector when moving it.

- Remove all the attachments including the power cord and cables from the projector before carrying the projector.

▶ Do not look into the lens or openings of the projector, while the lamp is on.

▶ Stay away from the lamp cover and exhaust vents when the projection lamp is on and when the lamp has just gone out since they will be very hot.

Regulatory notices

About Electro-Magnetic Interference

This is a Class A product. In a domestic environment this product may cause radio interference in which case the user may be required to take adequate measures.

This product may cause interference if used in residential areas. Such use must be avoided unless the user takes special measures to reduce electromagnetic emissions to prevent interference to the reception of radio and television broadcasts.

In Canada

This Class A digital apparatus complies with Canadian ICES-003.

In the US and places where the FCC regulations are applicable

This device complies with part 15 of the FCC Rules. Operation is subject to the following two conditions: (1) This device may not cause harmful interference, and (2) this device must accept any interference received, including interference that may cause undesired operation.

This equipment has been tested and found to comply with the limits for a Class A digital device, pursuant to Part 15 of the FCC Rules.

These limits are designed to provide reasonable protection against harmful interference when the equipment is operated in a commercial environment. This equipment generates, uses, and can radiate radio frequency energy and, if not installed and used in accordance with the instruction manual, may cause harmful interference to radio communications. Operation of this equipment in a residential area is likely to cause harmful interference in which case the user will be required to correct the interference at his own expense.

INSTRUCTIONS TO USERS: Some cables have to be used with a ferrite core. Use the accessory cable or a designated type cable for the connection. For cables that have a ferrite core on a single end, connect the ferrite core end to the projector.

CAUTION: Changes or modifications not expressly approved by the party responsible for compliance could void the user's authority to operate the equipment.

Regulatory notices (continued)

About Waste Electrical and Electronic Equipment

The following information is only for EU-member states:

The mark shown to the right is in compliance with the Waste Electrical and Electronic Equipment Directive 2002/96/EC (WEEE). The mark indicates the requirement NOT to dispose the equipment as unsorted municipal waste, but use the return and collection systems according to local laws.



Contents of package

Your projector should come with the items shown below. Check that all the items are included. Contact your dealer immediately if any items are missing.

- (1) Remote control (batteries not included)
- (2) Power cord
- (3) Computer cable
- (4) Lens cover
- (5) User's manual (Book x 1)
- (6) Adapter cover

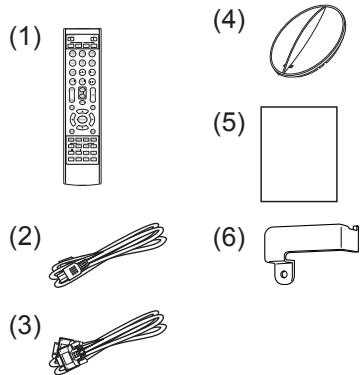

⚠ WARNING ► Keep small parts away from children and pets. Parts should not be placed in the mouth. If swallowed, consult a physician immediately for emergency treatment.

NOTE • Keep the original packing materials for future reshipment. Use the original packing materials when moving the projector. Use special caution for the lens.

• The projector may make a rattling sound when tilted, moved or shaken, since a flap to control the air flow inside of the projector will move. Be aware that this is not a failure or malfunction.

Preparing for the remote control

Please insert batteries (batteries not included) into the remote control before using it. If the remote control appears to malfunction, replace the batteries first. Remove the batteries from the remote control and store them in a safe place when the remote will not be used for a length of time.

1. Holding the hook part of the battery cover, remove it.
2. Align and insert two AA batteries (**HITACHI MAXELL** or **HITACHI MAXELL ENERGY, Part No.LR6** or **R6P**) according to their plus and minus terminals as indicated in the remote control.
3. Replace the battery cover in the direction of the arrow and snap it back into place.

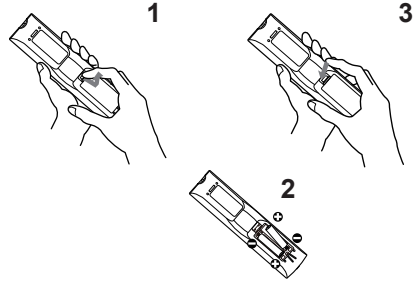

- ⚠ WARNING** ► Always handle the batteries with care and use them only as directed. Improper use may result in battery explosion, cracking or leakage, which could result in fire, injury and/or pollution of the surrounding environment.
- When replacing the batteries, replace both of the batteries with new batteries of the same type. Do not use a new battery with a used battery.
 - Only use the batteries specified. Do not use batteries of different types at the same time. Do not mix a new battery with used one.
 - Make sure the plus and minus terminals are correctly aligned when loading a battery.
 - Keep a battery away from children and pets.
 - Do not recharge, short circuit, solder or disassemble a battery.
 - Do not place a battery in a fire or water. Keep batteries in a dark, cool and dry place.
 - If you observe battery leakage, wipe out the leakage and then replace a battery. If the leakage adheres to your body or clothes, rinse well with water immediately.
 - Obey the local laws when disposing of batteries.

Arrangement

Refer to the following table and to tables **T-1** to **T-5** at the back of this manual to determine screen size and projection distance. The values shown in the table are calculated for a full size screen.

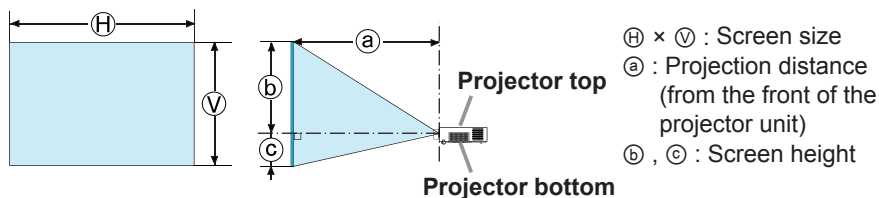

⚠ WARNING ▶ Install the projector where you can access the power outlet easily.

▶ Install the projector in a stable horizontal position.

- Do not use any mounting accessories except the accessories specified by the manufacturer. Read and keep all accessory manuals.
- For special installations such as ceiling mounting, consult your dealer beforehand. Specific mounting accessories and services may be required.
- Do not position the projector on its side, front or rear.
- Do not attach or place anything on the projector unless otherwise specified in the manual.

▶ Do not install the projector near thermally conductive or flammable items.

▶ Do not place the projector where any oils, such as cooking or machine oil, are used.

▶ Do not place the projector in a place where it may get wet.

⚠ CAUTION ▶ Place the projector in a cool place with sufficient ventilation.

- Keep a space of 30 cm or more between the side of the projector and other objects such as walls.
- Do not plug, block or cover the projector's ventilation holes.
- Do not place the projector in places that are exposed to magnetic fields. Doing so can cause the cooling fans inside the projector to malfunction.
- ▶ Avoid placing the projector in smoky, humid or dusty places.
- Do not place the projector near humidifiers.

NOTICE ▶ Position the projector to prevent light from directly hitting the projector's remote sensor.

▶ Do not place the product in a place where radio interference may be caused.

▶ Verify the ALTITUDE setting in the OPTION>SERVICE menu is correct.

Under normal circumstances, it is recommended that it be set to AUTO. If the projector is using the wrong setting, it may cause damage to the projector itself or to the parts inside. For details, see **User's Manual - Operating Guide**.

Connecting with your devices

Before connecting the projector to a device, review the device manual to ensure projector compatibility and to understand what accessories are needed for connection. Consult your dealer when the required accessory did not come with the product or the accessory is damaged.

After verifying that the projector and the devices are turned off, connect the equipment, according to the following instructions. Refer to figures **F-1** to **F-4** at the back of this manual.

For details, see **User's Manual - Operating Guide**. Before connecting the projector to a network system, read **User's Manual - Network Guide** too.

⚠ WARNING ► Use only compatible accessories. Otherwise a fire or projector and device damage may occur.

- Use only the accessories specified or recommended by the projector's manufacturer. Some regulations or standards may apply.
- Do not disassemble or modify the projector or its accessories.
- Do not use a damaged accessory. Be careful not to damage the accessories. Route cables so that they are not pinched or stepped on.
- Heat may build up in the USB wireless adapter, to avoid possible burns disconnect the projector power cord for 10 minutes before touching the adapter.
- When using the USB wireless adapter, connect the adapter to the further **USB TYPE A** port from the **LAN** port and use the supplied adapter cover (📖8).

⚠ CAUTION ► For a cable with a ferrite core at a single end, connect the end with the core to the projector. EMI regulations may apply.

- Before connecting the projector to a network system, obtain the consent of the network administrator.
- Do not connect the **LAN** port to any network that might have excessive voltage.
- The designated USB wireless adapter that is sold as an option uses the wireless network function of this projector. Before connecting the USB wireless adapter, turn off the power of the projector and disconnect the power cord.
- Before removing the USB storage device from the port of the projector, use the REMOVE USB function on the thumbnail screen to secure your data.

NOTE • Do not turn the projector on or off while connected to an operating device, unless directed by the device manual.

- Some input ports are user selectable. For details, see **User's Manual - Operating Guide**.
- Be careful not to connect a connector to a wrong port.
- If an oversized USB storage device blocks the **LAN** port, use a USB extension cable to connect the USB storage device.

Fastening the adapter cover

When using the USB wireless adapter, be sure to connect the adapter to the **USB TYPE A** port furthest away from the **LAN** port and use the supplied adapter cover.

1. Loosen the screw (marked with triangle) on the bottom left of the **USB TYPE A** ports.
2. Insert the cover tab into the hole at the upper right of the **USB TYPE A** ports in the direction of the arrow.
3. Align the screw holes on the projector and the cover. Then insert the screw removed from the projector into the hole and tighten the screw.

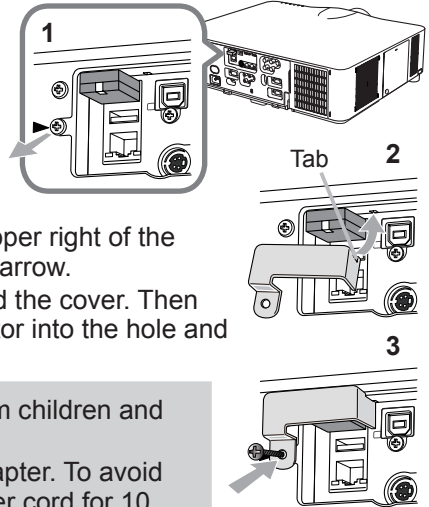

⚠ WARNING ▶ Keep small parts away from children and pets. Do not put any parts into the mouth.
▶ Heat may build up in the USB wireless adapter. To avoid possible burns disconnect the projector power cord for 10 minutes before touching the adapter.

Connecting power supply

1. Plug the power cord into the **AC IN** (AC inlet) connector of the projector.
2. Firmly plug the power cord's plug into the outlet. In a couple of seconds after the power supply connection, the **POWER** indicator will become a steady orange.

Please remember that when the **DIRECT POWER ON** function is activated, the power supply connection will make the projector turn on.

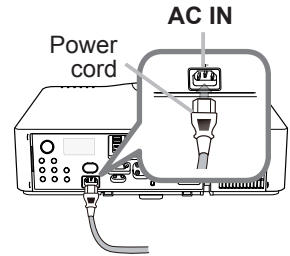

⚠ WARNING ▶ Do not connect the projector to a power supply when no lens unit is attached to it.
▶ Please use extra caution when connecting the power cord, as an incorrect or faulty connection may result in fire and/or electrical shock.

- Do not touch the power cord with a wet hand.
- Only use the power cord that came with the projector. If it is damaged, consult your dealer to get a new one. Never modify the power cord.
- Only plug the power cord into an outlet whose voltage is matched to the power cord. The power outlet should be close to the projector and easily accessible. Remove the power cord for complete separation.
- Do not distribute the power supply to multiple devices. Doing so may overload the outlet and connectors, loosen the connection, or result in fire, electric shock or other accidents.
- Connect the ground terminal for the AC inlet of this unit to the ground terminal of the building using an appropriate power cord (bundled).

NOTICE ▶ This product is also designed for IT power systems with a phase-to-phase voltage of 220 to 240 V.

Turning on the power

1. Make sure that the power cord is firmly and correctly connected to the projector and the outlet.
2. Make sure that the **POWER** indicator is steady orange. Then remove the lens cover.
3. Press the **STANDBY/ON** button on the projector or the **ON** button on the remote control.

The projection lamp will light up and the **POWER** indicator will begin blinking green. When the power is completely on, the indicator will stop blinking and become steady green.

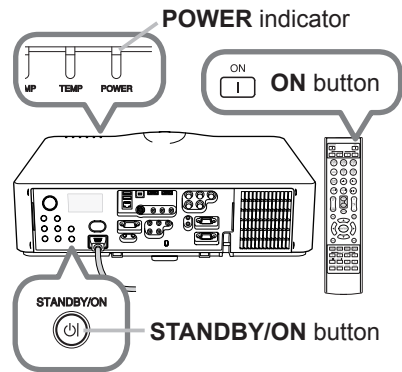

⚠ WARNING ► A strong light is emitted when the projector's power is on. Do not look into the projector lens or look inside of the projector through any of the projector's openings.

NOTE • Power on the projector prior to any connected devices.
 • The projector has a **DIRECT POWER ON** function, which can cause the projector to turn on automatically. For more information, please see **User's Manual - Operating Guide**.

Adjusting the projector's elevator

When the projector is placed on a slightly uneven surface, use the elevator feet to place the projector horizontally.

Using the feet can also tilt the projector in order to project at a suitable angle (up to 9 degrees) to the screen.

This projector has 2 elevator feet and 2 elevator buttons.

An elevator foot is adjustable when you push the elevator button which is on the same side.

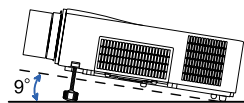

1. Holding the projector, push the elevator buttons to loosen the elevator feet.
2. Position the front side of the projector to the desired height.
3. Release the elevator buttons in order to lock the elevator feet.
4. After verifying that the elevator feet are locked, put the projector down gently.
5. If necessary, the elevator feet can be manually twisted to make more precise adjustments. Hold the projector when twisting the feet.

To loose an elevator foot, push the elevator button on the same side as it.

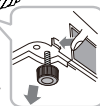

To finely adjust, twist the foot.



CAUTION ▶ Do not handle the elevator buttons without holding the projector, since the projector may drop down.

▶ Do not tilt the projector more than 9 degrees using the adjuster feet. Tilting the projector beyond this limitation could cause projector malfunction and shorten the life of the consumables. **For the IN5142, IN5144 and IN5145 only:** It is possible to install the IN5142, IN5144, and IN5145 projector in any direction with specified mounting accessories. Consult with your dealer about such special installations.

Adjusting the lens position

Shifting the lens position shifts the projection position.

After pressing the **LENS SHIFT** button on the control panel or the remote control, use the cursor buttons to shift the lens position.

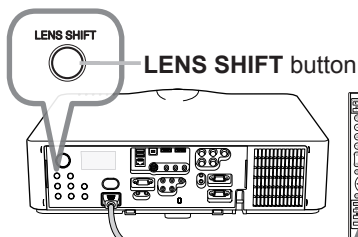

CAUTION ▶ Do not put your fingers or any other items around the lens. The moving lens could pinch them in the space around the lens and cause injury.

LENS SHIFT button

NOTE • The projector may ignore button operation when the lens is moving.
• Generally, better image quality is available when the lens is set to the center.

Displaying the picture

1. Activate your signal source. Turn the signal source on, and send the signal to the projector.
2. Press the **INPUT** button on the projector.
Each time you press the button, the projector switches its input port in turn.
You can also use the remote control to select an input signal. Press any of the buttons from **COMPUTER 1 / 2, LAN, USB TYPE A / B, HDMI 1 / 2, COMPONENT, S-VIDEO** or **VIDEO** to select the input signal from each port.
3. Use the **VOL + / -** buttons to adjust the volume.
4. Press the **ASPECT** button on the remote control. Each time you press the button, the projector switches the mode for aspect ratio in turn.
5. Use the **ZOOM + / -** buttons on the remote control or **ZOOM** button and **◀/▶** cursor buttons on the projector to adjust the screen size.
6. Use the **FOCUS + / -** buttons on the projector or the remote control to focus the picture.

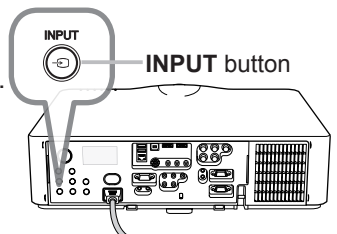

Buttons for input ports

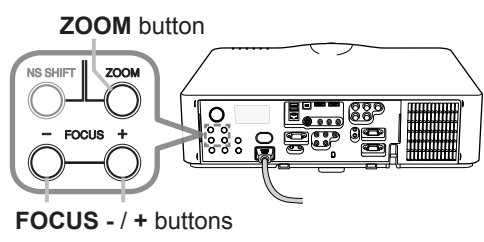
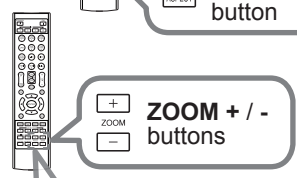
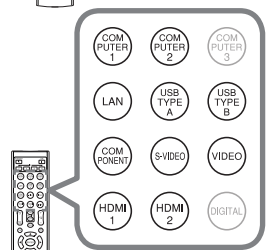
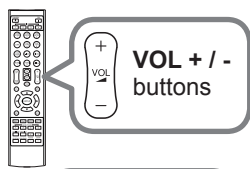

⚠ CAUTION ▶ If you wish to have a blank screen while the projector's lamp is on, use the lens shutter or AV MUTE function (see **User's Manual - Operating Guide**). Taking any other action may cause the damage on the projector.

NOTE • The **ASPECT** button does not work when no proper signal is inputted.
• For the details of how to adjust the picture, please see **User's Manual - Operating Guide**.

Turning off the power

1. Press the **STANDBY/ON** button on the projector or the **STANDBY** button on the remote control.
The message “Power off?” will appear on the screen for about 5 seconds.
2. Press the **STANDBY/ON** or **STANDBY** button again while the message appears.
The projector lamp will turn off, and the **POWER** indicator will begin blinking orange. Then the **POWER** indicator will stop blinking and become steady orange when the lamp is cooled sufficiently.
3. Attach the lens cover, after the **POWER** indicator becomes steady orange.
Do not turn the projector on for about 10 minutes or more after turning it off. Also, do not turn the projector off shortly after turning it on. Such operations might cause the lamp to malfunction or shorten the lifetime of some parts including the lamp.

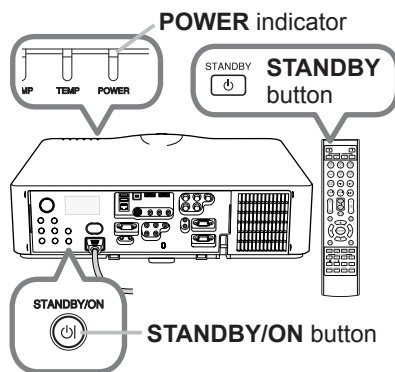

⚠ WARNING ► Do not touch around the lamp cover and the exhaust vents during use or just after use, since it is too hot.

► Remove the power cord for completely turn off the projector. The power outlet should be close to the projector and easily accessible.

NOTE • Power the projector off after all connected devices are powered off.
• This projector has an AUTO POWER OFF function which can make the projector turn off automatically. For more information, please see **User's Manual - Operating Guide**.

Replacing the lamp

A lamp has a finite product life. Using the lamp for long periods of time could cause the pictures to appear darker or the color tone to be poor. Note that each lamp has a different lifetime, and some may rupture or burn out soon after you start using them. It is recommended that you keep a spare lamp on hand. To order a new lamp, contact your dealer and tell them the lamp part number.

Part number <IN5132, IN5134, IN5135> : SP-LAMP-080

Part number <IN5142, IN5144, IN5145> : SP-LAMP-081

1. Turn the projector off, and unplug the power cord. Allow the projector to cool for at least 45 minutes.
2. Obtain a new lamp. If the projector is ceiling mounted, or if the lamp has broken, you can ask the dealer to replace the lamp for you, if desired.

In case of replacement by yourself, follow the following procedure.

3. Loosen the lamp cover screw (marked by arrow) and then slide the lamp cover down and remove the cover.
4. Loosen the 3 lamp screws (marked by arrows), and slowly pull the lamp out by the handles. Never loosen any other screws.
5. Insert the new lamp, and retighten the 3 lamp screws firmly to lock them in place.
6. Align the lamp cover with the projector and slide the lamp cover back in place. Then firmly fasten the lamp cover screw.
7. Turn the projector on and reset the lamp time using the LAMP TIME item in the OPTION menu.

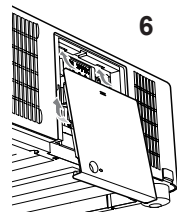
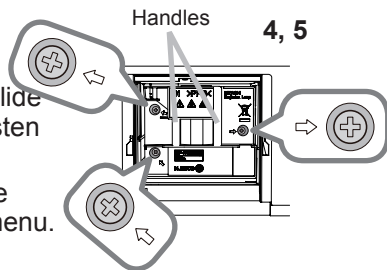
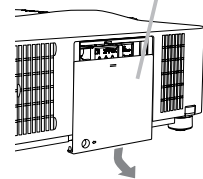
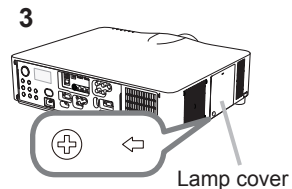

- (1) Press the **MENU** button to display the menu.
- (2) Highlight **ADVANCED MENU** in the menu using the **▼/▲** buttons, then press the **▶** button.
- (3) Highlight **OPTION** in the left column of the menu using the **▼/▲** buttons, then press the **▶** button.
- (4) Highlight **LAMP TIME** using the **▼/▲** buttons, then press the **▶** button. A dialog will appear.
- (5) Press the **▶** button to select "OK" on the dialog and reset the lamp time

⚠ CAUTION ▶ Do not touch the inside of the projector, while the lamp is taken out.

NOTE • Only reset the lamp time after replacing the lamp to ensure proper functioning of the lamp counter.

Replacing the lamp (continued)



HIGH VOLTAGE



HIGH TEMPERATURE



HIGH PRESSURE

⚠ WARNING ► The projector uses a high-pressure mercury glass lamp. The lamp may burn out or rupture with a loud bang if the lamp is jolted or scratched, handled while hot, or worn over time. Note that each lamp has a different lifetime, and some may rupture or burn out soon after you start using them. In addition, if the bulb ruptures, it is possible for shards of glass to fly into the lamp housing, and for gas containing mercury and dust containing fine particles of glass to escape from the projector's vent holes.

► **About disposal of a lamp:** This product contains a mercury lamp; do not put it in a trash. Dispose of it in accordance with environmental laws.

• For lamp recycling, go to www.lamprecycle.org (in the US).

• For product disposal, consult your local government agency or www.eiae.org (in the US) or www.epsc.ca (in Canada).

For more information, ask your dealer.



Disconnect the plug from the power outlet

- If the lamp should break (it will make a loud bang when it does), unplug the power cord from the outlet, and make sure to request a replacement lamp from your local dealer. Note that shards of glass could damage the projector's internals, or cause injury during handling, so please do not try to clean the projector or replace the lamp yourself.
- If the lamp should break (it will make a loud bang when it does), ventilate the room well, and make sure not to inhale the gas or fine particles that come out from the projector's vent holes, and not to get them into your eyes or mouth.
- Before replacing the lamp, turn the projector off and unplug the power cord, then wait at least 45 minutes for the lamp to cool sufficiently. Handling the lamp while hot can cause burns, as well as lamp damage



- Never unscrew anything except the designated (marked by an arrow) screws.
- Do not open the lamp cover while the projector is suspended from a ceiling. This is dangerous, since if the lamp's bulb has broken, the shards will fall out when the cover is opened. In addition, working in high places is dangerous, so ask your local dealer to have the lamp replaced even if the bulb is not broken.
- Do not use the projector with the lamp cover removed. At the lamp replacing, make sure that the screws are screwed in firmly. Loose screws could result in damage or injury.



- Use only specified lamps. Lamps which do not meet lamp specifications for this model could cause a fire, damage or shorten the life of this product.
- If the lamp breaks soon after the first time it is used, it is possible that there are electrical problems elsewhere besides the lamp. If this happens, consult your local dealer or service representative.
- Handle with care: jolting or scratching could cause the lamp bulb to rupture during use.
- Using the lamp for long periods of time can cause the lamp to become dim, not to light up or to rupture. When the pictures appear dark, or when the color tone is poor, please replace the lamp as soon as possible. Do not use old (used) lamps; this is a cause of breakage.

Cleaning and replacing the air filter

Please check and clean the air filter periodically. When the indicators or a message prompts you to clean the air filter, comply with it as soon as possible. The filter unit with 2 sheets of filters is inside of the filter cover. In addition, the extra air filter is attached to inner side of the filter cover of **IN5142**, **IN5144** and **IN5145**. If one of the filters is damaged or heavily soiled, replace whole filter set with a new one.

Request for a filter set with the following part number from your dealer when purchasing a new one.

Part number <IN5132, IN5134, IN5135>: SP-FILTER-02

Part number <IN5142, IN5144, IN5145>: SP-FILTER-03

1. Turn the projector off, and unplug the power cord. Allow the projector to sufficiently cool down.
2. Use a vacuum cleaner on and around the filter cover.
3. Pick and pull up the filter cover knobs to take it off.
4. Press up slightly the bottom side knobs to unlock the bottom side of the filter unit. Pull the center knob to take the filter unit off.
5. Use a vacuum cleaner for the filter vent of the projector and the outer side of the filter unit.
6. The filter unit consists of two parts. Press down around the interlocking parts to unlock, then separate the two parts.
7. Use a vacuum cleaner for the inner side of each part of the filter unit to clean them up. If the filters are damaged or heavily soiled, replace them with the new ones.
8. Combine the two parts to reassemble the filter unit.
9. Put the filter unit back into the projector.

(continued on next page)

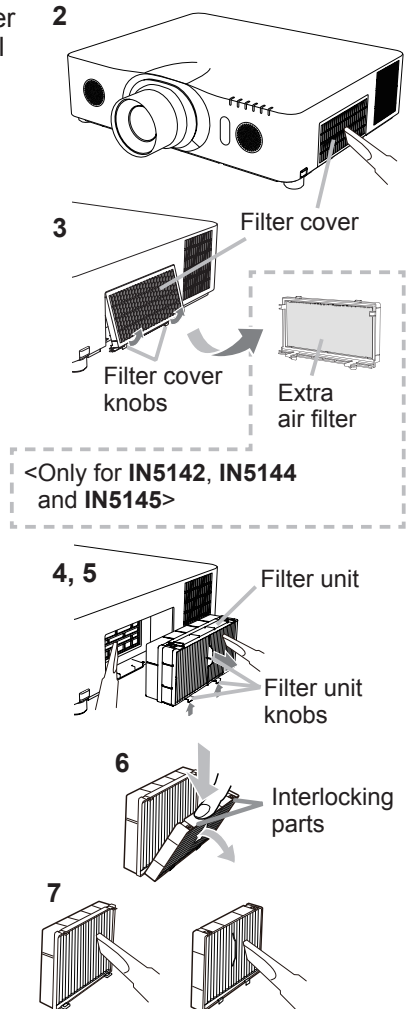

Cleaning and replacing the air filter (continued)

10. Put the filter cover back into the place.
11. Turn the projector on and reset the filter time using the FILTER TIME item in the EASY MENU.
 - (1) Press the **MENU** button to display the menu.
 - (2) Highlight FILTER TIME using the ▲/▼ cursor buttons, then press the ► cursor (or the **ENTER** / the **RESET**) button. A dialog will appear.
 - (3) Press the ► cursor button to select the “OK” on the dialog. It resets the filter time.

⚠WARNING ► Before taking care of the air filter, make sure the power cable is not plugged in, then allow the projector to cool sufficiently.

► Use only the air filter of the specified type. Do not use the projector without the air filter or the filter cover. It could result in a fire or malfunction to the projector.

► Clean the air filter periodically. If the air filter becomes clogged by dust or the like, internal temperatures rise and could cause a fire, a burn or malfunction to the projector.

NOTE • Please reset the filter time only when you have cleaned or replaced the air filter to ensure proper air filter messages.

• The projector may display the message such as the “CHECK THE AIR FLOW” or turn off the projector, to prevent the internal heat level rising.

Specifications

Item	Specification
Product name	Liquid crystal projector
Liquid Crystal Panel	IN5132, IN5142: 786,432 pixels (1024 horizontal x 768 vertical) IN5134, IN5144: 1,024,000 pixels (1280 horizontal x 800 vertical) IN5135, IN5145: 2,304,000 pixels (1920 horizontal x 1200 vertical)
Lamp	IN5132, IN5134, IN5135: 245W UHP IN5142, IN5144, IN5145: 330W UHP
Speaker	8 W x2
Power supply, Rated current	IN5132, IN5134, IN5135: AC100-120 V: 3.8 A, AC220-240 V: 1.9 A IN5142, IN5144, IN5145: AC100-120 V: 4.9 A, AC220-240 V: 2.4 A
Power consumption	IN5132, IN5134, IN5135: AC100-120 V: 375 W, AC220-240 V: 355 W IN5142, IN5144, IN5145: AC100-120 V: 480 W, AC220-240 V: 455 W
Temperature range	IN5132, IN5134, IN5135: 0 ~ 40 °C (Operating) IN5142, IN5144, IN5145: 0 ~ 45 °C (Operating) * When the projector is used at high altitudes, even with the IN5142, IN5144 or IN5145 , the service life of the optical components may be reduced by peripheral temperatures of over about 40°C. It is recommended to reduce the temperature as far as possible.
Size	498 (W) x 135 (H) x 396 (D) mm * Not including protruding parts. Refer to figure F-5 at the back of this manual.
Weight (mass)	IN5132, IN5134: approx. 8.3 kg IN5135: approx. 8.6 kg IN5142, IN5144, IN5145: approx. 8.7 kg

(continued on next page)

Specifications (continued)

Item	Specification
Ports	<p>COMPUTER IN1 D-sub 15 pin mini jack x1</p> <p>COMPUTER IN2 (H, V, G/Y, B/Cb/Pb, R/Cr/Pr) ... BNC jack x5</p> <p>HDMI 1 HDMI connector x1</p> <p>HDMI 2 HDMI connector x1</p> <p>MONITOR OUT D-sub 15 pin mini jack x1</p> <p>COMPONENT (Y, Cb/Pb, Cr/Pr) RCA jack x3</p> <p>S-VIDEO Mini DIN 4 pin jack x1</p> <p>VIDEO RCA jack x1</p> <p>AUDIO IN1 3.5 mm (stereo) mini jack x1</p> <p>AUDIO IN2 3.5 mm (stereo) mini jack x1</p> <p>AUDIO IN3 (L, R) RCA jack x2</p> <p>AUDIO OUT (L, R) RCA jack x2</p> <p>USB TYPE A USB type A connector x2</p> <p>USB TYPE B USB type B connector x1</p> <p>CONTROL D-sub 9 pin plug x1</p> <p>LAN RJ45 jack x1</p> <p>REMOTE CONTROL IN 3.5 mm (stereo) mini jack x1</p> <p>REMOTE CONTROL OUT 3.5 mm (stereo) mini jack x1</p>
Optional parts	<p>Lamp:</p> <p>SP-LAMP-080 <IN5132, IN5134, IN5135></p> <p>SP-LAMP-081 <IN5142, IN5144, IN5145></p> <p>Filter set:</p> <p>SP-FILTER-02 <IN5132, IN5134, IN5135></p> <p>SP-FILTER-03 <IN5142, IN5144, IN5145></p> <p>Lens unit: LENS-069 (Fixed short throw lens)</p> <p>LENS-070 (Short throw lens)</p> <p>LENS-071 (Middle throw lens)</p> <p>LENS-072 (Long throw lens)</p> <p>LENS-073 (Ultra long throw lens)</p> <p>USB wireless adapter: SP-DONGLE-USB</p> <p>* For more information, please consult your dealer.</p>

Troubleshooting - Warranty and after-service

Never use the product during or after an abnormal situation (for example, when the projector is smoking, smells strange, had a liquid spilled on it, had an object put inside it, is broken, etc.). If an abnormality should occur, unplug the projector immediately.

Otherwise if a problem occurs with the projector, refer to the “Troubleshooting” sections of **User’s Manual - Operating Guide, Instant Stack Guide and Network Guide**, and run through the suggested checks.

If this does not resolve the problem, please consult your dealer or service company. They will tell you if your projector is still under warranty.

You can find the latest information for this projector at the following web address:

Product information and Manuals :

www.infocus.com/support

NOTE • The information in this manual is subject to change without notice.

- The illustrations shown in this manual are used for example purposes only. Your projector may differ from the illustrations shown.
- The manufacturer assumes no responsibility for any errors that may appear in this manual.
- The reproduction, transfer or copy of all or any part of this document is not permitted without express written consent.

Trademark acknowledgment

- Mac[®], Macintosh[®] and Mac OS[®] are registered trademarks of Apple Inc.
 - Pentium[®] is a registered trademark of Intel Corp.
 - Adobe[®] and Acrobat[®], Reader[®] are registered trademarks of Adobe Systems Incorporated.
 - Microsoft[®], Internet Explorer[®], Windows[®], Windows NT[®] and Windows Vista[®] are registered trademarks of Microsoft Corporation in the U.S. and/or other countries.
 - HDMI[™], the HDMI logo and High-Definition Multimedia Interface are trademarks or registered trademarks of HDMI Licensing LLC in the United States and other countries.
 - Blu-ray Disc[™] and Blu-ray[™] are trademarks of Blu-ray Disc Association.
- All other trademarks are the properties of their respective owners.

End User License Agreement for the Projector Software

- Software in the projector consists of multiple independent software modules and there are copyrights or/and third party copyrights for each of the software modules.
- Be sure to read the “End User License Agreement for the Projector Software” on the next page.

End User License Agreement for the Projector Software

Software in the projector consists of the plural number of independent software modules and there exist our copyright or/and third party copyrights for each of such software modules. The projector also uses software modules that we have developed or/and produced. And there exist our copyright and intellectual property for each of such software and related items including but not limited to the software related documents.

These rights above are protected by copyright law and other applicable laws. And the projector uses software modules licensed as Freeware upon GNU GENERAL PUBLIC LICENSE Version 2 and GNU LESSER GENERAL PUBLIC LICENSE Version 2.1 established by Free Software Foundation, Inc. (U.S.) or license agreements for each software.

Refer to the following web page for license agreements for such software modules and other software: <http://www.infocus.com>

Contact dealer in your region for inquiry regarding licensed software. Refer to license agreement of each software in following pages and license agreements of each software on the web page for detail of the license conditions and so on. (The original in English is carried since the license agreement following is established by third party other than us.)

Because the program (the software module) is licensed free of charge, the program is provided "as is" without warranty of any kind, either expressed or implied, to the extent permitted by applicable law. And we do not take any responsibility or compensate for loss of any kind (including but not limited to loss of data, loss of accuracy or loss of compatibility with interface between other programs) by the software concerned or/and use of the software concerned to the extent permitted by applicable law.

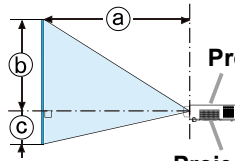
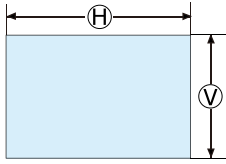

Projector top
Projector bottom

- Ⓜ x Ⓥ : Screen size
- ⓐ : Projection distance (from the front of the projector unit)
- ⓑ , ⓒ : Screen height

T-1 IN5132/IN5132c with LENS-070

(1024 x 768, ±10%)

Screen type	4 : 3										16 : 9									
	Screen size		Projection distance				Screen height				Screen size		Projection distance				Screen height			
	Ⓜ	Ⓥ	ⓐ min.		ⓐ max.		ⓑ		ⓒ		Ⓜ	Ⓥ	ⓐ min.		ⓐ max.		ⓑ		ⓒ	
(inch)	m	m	m	inch	m	inch	cm	inch	cm	inch	m	m	m	inch	m	inch	cm	inch	cm	inch
30	0.6	0.5	0.9	37	1.4	55	51	20	-6	-2	0.7	0.4	1.0	40	1.5	60	50	20	-12	-5
40	0.8	0.6	1.2	49	1.9	73	69	27	-8	-3	0.9	0.5	1.3	53	2.0	79	66	26	-17	-7
50	1.0	0.8	1.5	61	2.3	91	86	34	-10	-4	1.1	0.6	1.7	66	2.5	99	83	33	-21	-8
60	1.2	0.9	1.8	73	2.8	109	103	41	-11	-5	1.3	0.7	2.0	79	3.0	119	100	39	-25	-10
70	1.4	1.1	2.1	84	3.2	127	120	47	-13	-5	1.5	0.9	2.3	92	3.5	138	116	46	-29	-11
80	1.6	1.2	2.4	96	3.7	145	137	54	-15	-6	1.8	1.0	2.7	105	4.0	158	133	52	-33	-13
90	1.8	1.4	2.8	108	4.1	163	154	61	-17	-7	2.0	1.1	3.0	118	4.5	177	149	59	-37	-15
100	2.0	1.5	3.1	120	4.6	181	171	68	-19	-8	2.2	1.2	3.3	131	5.0	197	166	65	-42	-16
150	3.0	2.3	4.6	180	6.9	271	257	101	-29	-11	3.3	1.9	5.0	196	7.5	295	249	98	-62	-25
200	4.1	3.0	6.1	239	9.2	361	343	135	-38	-15	4.4	2.5	6.6	261	10.0	393	332	131	-83	-33
250	5.1	3.8	7.6	299	11.5	451	429	169	-48	-19	5.5	3.1	8.3	326	12.5	491	415	163	-104	-41
300	6.1	4.6	9.1	359	13.7	541	514	203	-57	-23	6.6	3.7	9.9	391	15.0	589	498	196	-125	-49
600	12.2	9.1	18.2	716	27.5	1081	1029	405	-114	-45	13.3	7.5	19.8	780	29.9	1178	996	392	-249	-98

T-2 IN5142/IN5142c with LENS-071

(1024 x 768, ±10%)

Screen type	4 : 3										16 : 9									
	Screen size		Projection distance				Screen height				Screen size		Projection distance				Screen height			
	Ⓜ	Ⓥ	ⓐ min.		ⓐ max.		ⓑ		ⓒ		Ⓜ	Ⓥ	ⓐ min.		ⓐ max.		ⓑ		ⓒ	
(inch)	m	m	m	inch	m	inch	cm	inch	cm	inch	m	m	m	inch	m	inch	cm	inch	cm	inch
30	0.6	0.5	0.9	37	1.9	73	46	18	0	0	0.7	0.4	1.0	40	2.0	80	44	17	-6	-2
40	0.8	0.6	1.2	49	2.5	97	61	24	0	0	0.9	0.5	1.4	53	2.7	106	58	23	-8	-3
50	1.0	0.8	1.6	61	3.1	121	76	30	0	0	1.1	0.6	1.7	67	3.4	132	73	29	-10	-4
60	1.2	0.9	1.9	73	3.7	146	91	36	0	0	1.3	0.7	2.0	80	4.0	159	87	34	-12	-5
70	1.4	1.1	2.2	86	4.3	170	107	42	0	0	1.5	0.9	2.4	93	4.7	185	102	40	-15	-6
80	1.6	1.2	2.5	98	4.9	194	122	48	0	0	1.8	1.0	2.7	106	5.4	211	116	46	-17	-7
90	1.8	1.4	2.8	110	5.5	218	137	54	0	0	2.0	1.1	3.0	120	6.0	238	131	51	-19	-7
100	2.0	1.5	3.1	122	6.2	242	152	60	0	0	2.2	1.2	3.4	133	6.7	264	145	57	-21	-8
150	3.0	2.3	4.6	183	9.2	363	229	90	0	0	3.3	1.9	5.1	199	10.0	396	218	86	-31	-12
200	4.1	3.0	6.2	244	12.3	484	305	120	0	0	4.4	2.5	6.7	266	13.4	527	291	114	-42	-16
250	5.1	3.8	7.7	305	15.4	605	381	150	0	0	5.5	3.1	8.4	332	16.7	659	363	143	-52	-20
300	6.1	4.6	9.3	366	18.4	725	457	180	0	0	6.6	3.7	10.1	398	20.1	790	436	172	-62	-25
600	12.2	9.1	18.6	731	36.8	1450	914	360	0	0	13.3	7.5	20.2	796	40.1	1580	872	343	-125	-49

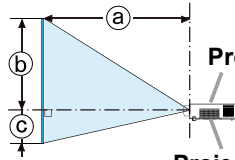
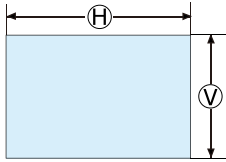

- Ⓜ x Ⓥ : Screen size
- ⓐ : Projection distance
(from the front of the projector unit)
- ⓑ , ⓒ : Screen height

Projector bottom

T-3 IN5134/IN5134c with LENS-070

(1280 x 800, ±10%)

Screen type	16 : 10										4 : 3									
	Screen size		Projection distance				Screen height				Screen size		Projection distance				Screen height			
	(H)	(V)	(a) min.		(a) max.		(b)		(c)		(H)	(V)	(a) min.		(a) max.		(b)		(c)	
(inch)	m	m	m	inch	m	inch	cm	inch	cm	inch	m	m	m	inch	m	inch	cm	inch	cm	inch
30	0.6	0.4	1.0	39	1.5	58	50	20	-10	-4	0.6	0.5	1.1	44	1.7	66	57	23	-11	-5
40	0.9	0.5	1.3	52	2.0	77	67	26	-13	-5	0.8	0.6	1.5	58	2.2	87	76	30	-15	-6
50	1.1	0.7	1.6	64	2.4	96	84	33	-17	-7	1.0	0.8	1.8	73	2.8	109	95	38	-19	-8
60	1.3	0.8	2.0	77	2.9	115	101	40	-20	-8	1.2	0.9	2.2	87	3.3	131	114	45	-23	-9
70	1.5	0.9	2.3	89	3.4	135	118	46	-24	-9	1.4	1.1	2.6	101	3.9	152	133	53	-27	-11
80	1.7	1.1	2.6	102	3.9	154	135	53	-27	-11	1.6	1.2	2.9	115	4.4	174	152	60	-30	-12
90	1.9	1.2	2.9	115	4.4	173	151	60	-30	-12	1.8	1.4	3.3	130	5.0	195	171	68	-34	-14
100	2.2	1.3	3.2	127	4.9	192	168	66	-34	-13	2.0	1.5	3.7	144	5.5	217	191	75	-38	-15
150	3.2	2.0	4.8	191	7.3	287	252	99	-50	-20	3.0	2.3	5.5	216	8.3	325	286	113	-57	-23
200	4.3	2.7	6.4	254	9.7	383	337	132	-67	-26	4.1	3.0	7.3	287	11.0	433	381	150	-76	-30
250	5.4	3.4	8.0	317	12.1	478	421	166	-84	-33	5.1	3.8	9.1	359	13.7	541	476	188	-95	-38
300	6.5	4.0	9.7	380	14.6	573	505	199	-101	-40	6.1	4.6	10.9	430	16.5	649	572	225	-114	-45
600	12.9	8.1	19.3	759	29.1	1146	1010	397	-202	-79	12.2	9.1	21.8	859	32.9	1297	1143	450	-229	-90

T-4 IN5144/IN5144c with LENS-071

(1280 x 800, ±10%)

Screen type	16 : 10										4 : 3									
	Screen size		Projection distance				Screen height				Screen size		Projection distance				Screen height			
	(H)	(V)	(a) min.		(a) max.		(b)		(c)		(H)	(V)	(a) min.		(a) max.		(b)		(c)	
(inch)	m	m	m	inch	m	inch	cm	inch	cm	inch	m	m	m	inch	m	inch	cm	inch	cm	inch
30	0.6	0.4	1.0	39	2.0	78	45	18	-4	-2	0.6	0.5	1.1	44	2.2	88	51	20	-5	-2
40	0.9	0.5	1.3	52	2.6	103	60	24	-6	-2	0.8	0.6	1.5	59	3.0	117	68	27	-7	-3
50	1.1	0.7	1.6	65	3.3	129	75	29	-7	-3	1.0	0.8	1.9	73	3.7	146	85	33	-8	-3
60	1.3	0.8	2.0	78	3.9	154	90	35	-9	-4	1.2	0.9	2.2	88	4.4	175	102	40	-10	-4
70	1.5	0.9	2.3	91	4.6	180	105	41	-10	-4	1.4	1.1	2.6	103	5.2	204	119	47	-12	-5
80	1.7	1.1	2.6	104	5.2	206	120	47	-12	-5	1.6	1.2	3.0	117	5.9	233	135	53	-14	-5
90	1.9	1.2	3.0	117	5.9	231	135	53	-13	-5	1.8	1.4	3.4	132	6.6	262	152	60	-15	-6
100	2.2	1.3	3.3	129	6.5	257	150	59	-15	-6	2.0	1.5	3.7	147	7.4	291	169	67	-17	-7
150	3.2	2.0	4.9	194	9.8	385	224	88	-22	-9	3.0	2.3	5.6	220	11.1	436	254	100	-25	-10
200	4.3	2.7	6.6	259	13.0	513	299	118	-30	-12	4.1	3.0	7.4	293	14.7	580	339	133	-34	-13
250	5.4	3.4	8.2	323	16.3	641	374	147	-37	-15	5.1	3.8	9.3	366	18.4	725	423	167	-42	-17
300	6.5	4.0	9.8	388	19.5	769	449	177	-45	-18	6.1	4.6	11.1	439	22.1	870	508	200	-51	-20
600	12.9	8.1	19.7	775	39.0	1537	897	353	-90	-35	12.2	9.1	22.3	877	44.2	1740	1016	400	-102	-40

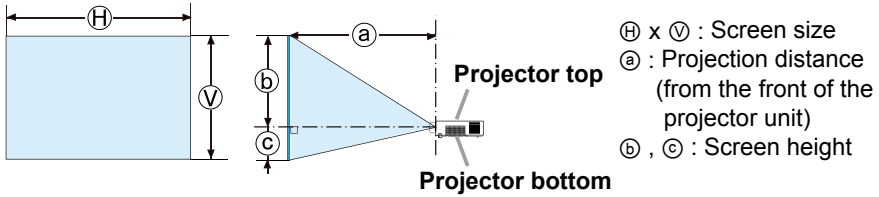

T-5 IN5135/IN5135c/IN5145/IN5145c with LENS-071 (1920 x 1200, $\pm 10\%$)

Screen type	16 : 10										4 : 3									
	Screen size		Projection distance				Screen height				Screen size		Projection distance				Screen height			
	(H)	(V)	(a) min.		(a) max.		(b)		(c)		(H)	(V)	(a) min.		(a) max.		(b)		(c)	
(inch)	m	m	m	inch	m	inch	cm	inch	cm	inch	m	m	m	inch	m	inch	cm	inch	cm	inch
30	0.6	0.4	1.0	38	1.9	76	45	18	-4	-2	0.6	0.5	1.1	43	2.2	86	51	20	-5	-2
40	0.9	0.5	1.3	51	2.6	101	60	24	-6	-2	0.8	0.6	1.5	58	2.9	114	68	27	-7	-3
50	1.1	0.7	1.6	64	3.2	126	75	29	-7	-3	1.0	0.8	1.8	72	3.6	143	85	33	-8	-3
60	1.3	0.8	1.9	76	3.8	151	90	35	-9	-4	1.2	0.9	2.2	86	4.3	171	102	40	-10	-4
70	1.5	0.9	2.3	89	4.5	176	105	41	-10	-4	1.4	1.1	2.6	100	5.1	200	119	47	-12	-5
80	1.7	1.1	2.6	101	5.1	202	120	47	-12	-5	1.6	1.2	2.9	115	5.8	228	135	53	-14	-5
90	1.9	1.2	2.9	114	5.8	227	135	53	-13	-5	1.8	1.4	3.3	129	6.5	256	152	60	-15	-6
100	2.2	1.3	3.2	127	6.4	252	150	59	-15	-6	2.0	1.5	3.6	143	7.2	285	169	67	-17	-7
150	3.2	2.0	4.8	190	9.6	377	224	88	-22	-9	3.0	2.3	5.5	215	10.8	427	254	100	-25	-10
200	4.3	2.7	6.4	253	12.8	503	299	118	-30	-12	4.1	3.0	7.3	286	14.5	569	339	133	-34	-13
250	5.4	3.4	8.0	316	16.0	628	374	147	-37	-15	5.1	3.8	9.1	358	18.1	711	423	167	-42	-17
300	6.5	4.0	9.6	379	19.1	754	449	177	-45	-18	6.1	4.6	10.9	429	21.7	853	508	200	-51	-20
600	12.9	8.1	19.3	758	38.3	1507	897	353	-90	-35	12.2	9.1	21.8	859	43.3	1706	1016	400	-102	-40

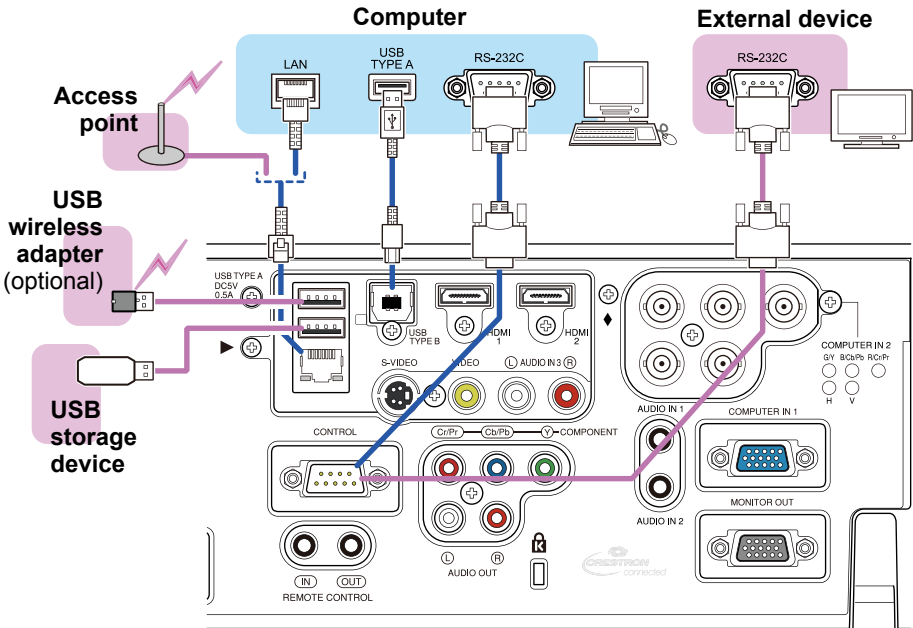
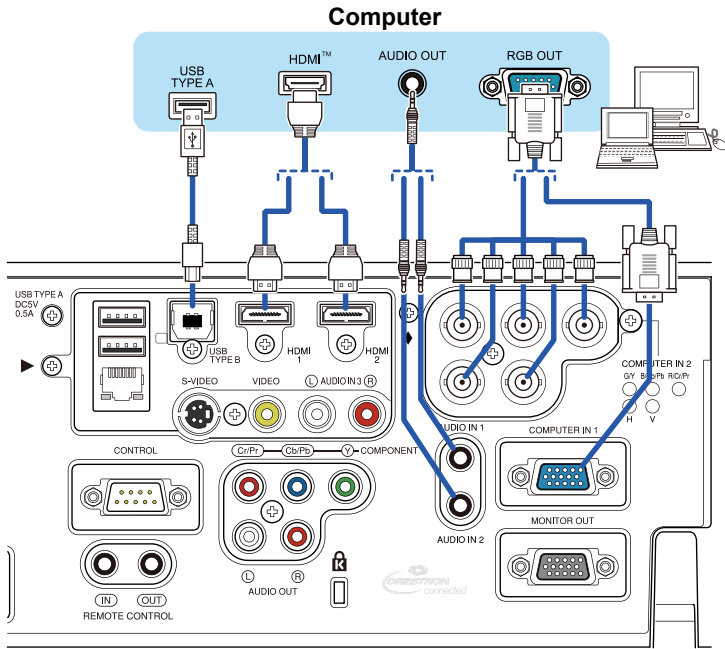

VCR/DVD/Blu-ray Disc™ player

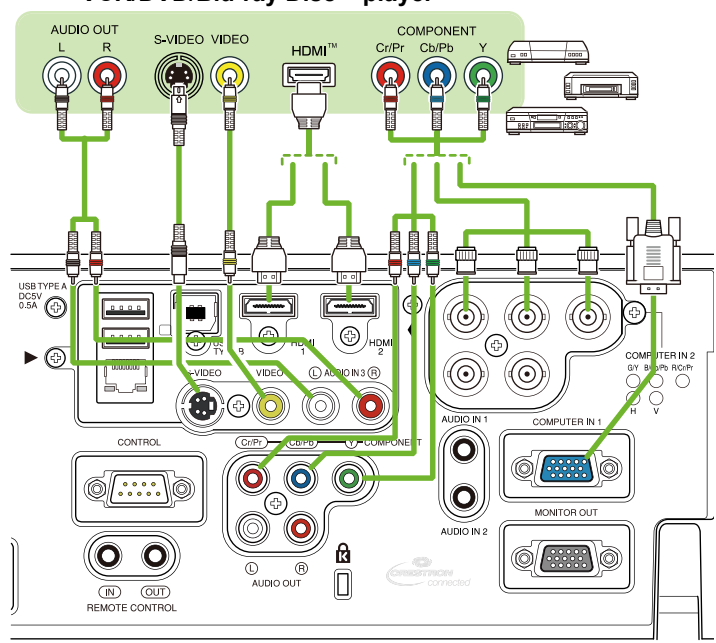

Speakers (with an amplifier)

Monitor

Another projector

(Wired) Remote control

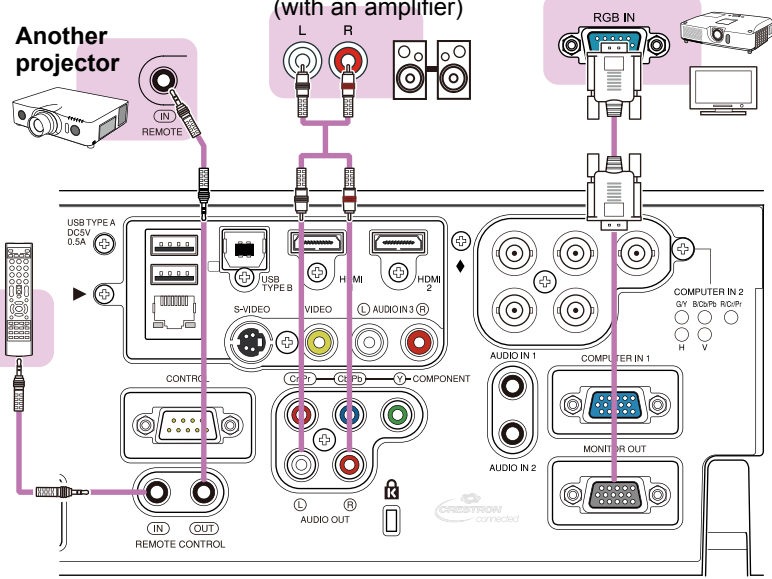

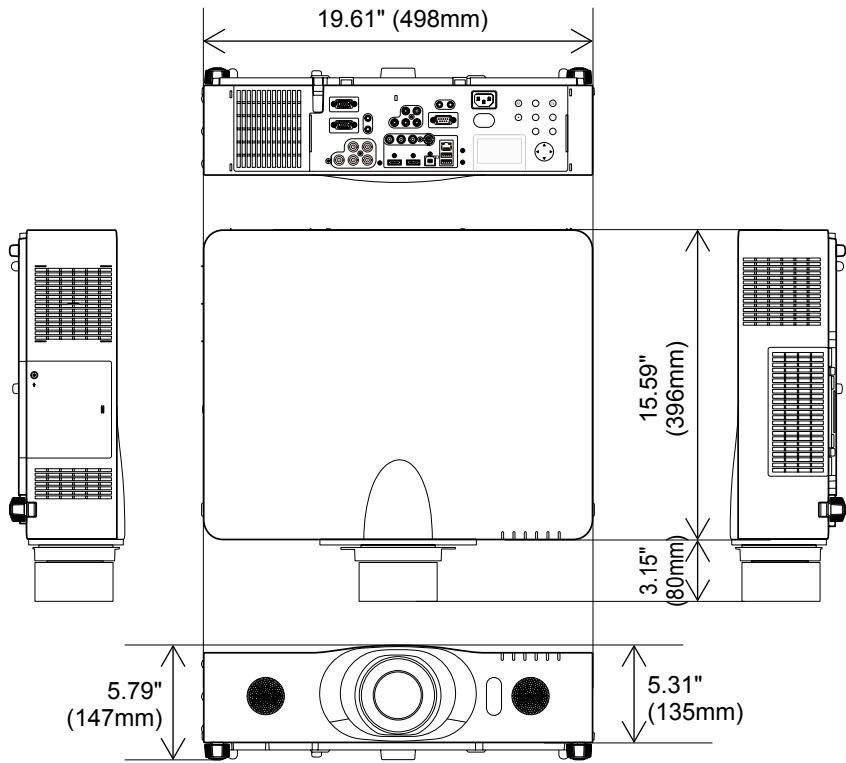

GNU GENERAL PUBLIC LICENSE

Version 2, June 1991

Copyright © 1989, 1991 Free Software Foundation, Inc.

51 Franklin St, Fifth Floor, Boston, MA 02110-1301 USA

Everyone is permitted to copy and distribute verbatim copies of this license document, but changing it is not allowed.

Preamble

The licenses for most software are designed to take away your freedom to share and change it. By contrast, the GNU General Public License is intended to guarantee your freedom to share and change free software--to make sure the software is free for all its users. This General Public License applies to most of the Free Software Foundation's software and to any other program whose authors commit to using it. (Some other Free Software Foundation software is covered by the GNU Library General Public License instead.) You can apply it to your programs, too. When we speak of free software, we are referring to freedom, not price. Our General Public Licenses are designed to make sure that you have the freedom to distribute copies of free software (and charge for this service if you wish), that you receive source code or can get it if you want it, that you can change the software or use pieces of it in new free programs; and that you know you can do these things.

To protect your rights, we need to make restrictions that forbid anyone to deny you these rights or to ask you to surrender the rights. These restrictions translate to certain responsibilities for you if you distribute copies of the software, or if you modify it. For example, if you distribute copies of such a program, whether gratis or for a fee, you must give the recipients all the rights that you have. You must make sure that they, too, receive or can get the source code. And you must show them these terms so they know their rights. We protect your rights with two steps: (1) copyright the software, and (2) offer you this license which gives you legal permission to copy, distribute and/or modify the software. Also, for each author's protection and ours, we want to make certain that everyone understands that there is no warranty for this free software. If the software is modified by someone else and passed on, we want its recipients to know that what they have is not the original, so that any problems introduced by others will not reflect on the original authors' reputations. Finally, any free program is threatened constantly by software patents. We wish to avoid the danger that redistributors of a free program will individually obtain patent licenses, in effect making the program proprietary. To prevent this, we have made it clear that any patent must be licensed for everyone's free use or not licensed at all.

The precise terms and conditions for copying, distribution and modification follow.
GNU GENERAL PUBLIC LICENSE TERMS AND CONDITIONS FOR COPYING,
DISTRIBUTION AND MODIFICATION

0. This License applies to any program or other work which contains a notice placed by

the copyright holder saying it may be distributed under the terms of this General Public License. The "Program", below, refers to any such program or work, and a "work based on the Program" means either the Program or any derivative work under copyright law: that is to say, a work containing the Program or a portion of it, either verbatim or with modifications and/or translated into another language. (Hereinafter, translation is included without limitation in the term "modification".) Each licensee is addressed as "you". Activities other than copying, distribution and modification are not covered by this License; they are outside its scope. The act of running the Program is not restricted, and the output from the Program is covered only if its contents constitute a work based on the Program (independent of having been made by running the Program). Whether that is true depends on what the Program does.

1. You may copy and distribute verbatim copies of the Program's source code as you receive it, in any medium, provided that you conspicuously and appropriately publish on each copy an appropriate copyright notice and disclaimer of warranty; keep intact all the notices that refer to this License and to the absence of any warranty; and give any other recipients of the Program a copy of this License along with the Program. You may charge a fee for the physical act of transferring a copy, and you may at your option offer warranty protection in exchange for a fee.
2. You may modify your copy or copies of the Program or any portion of it, thus forming a work based on the Program, and copy and distribute such modifications or work under the terms of Section 1 above, provided that you also meet all of these conditions:
 - a) You must cause the modified files to carry prominent notices stating that you changed the files and the date of any change.
 - b) You must cause any work that you distribute or publish, that in whole or in part contains or is derived from the Program or any part thereof, to be licensed as a whole at no charge to all third parties under the terms of this License.
 - c) If the modified program normally reads commands interactively when run, you must cause it, when started running for such interactive use in the most ordinary way, to print or display an announcement including an appropriate copyright notice and a notice that there is no warranty (or else, saying that you provide a warranty) and that users may redistribute the program under these conditions, and telling the user how to view a copy of this License. (Exception: if the Program itself is interactive but does not normally print such an announcement, your work based on the Program is not required to print an announcement.)These requirements apply to the modified work as a whole. If identifiable sections of that work are not derived from the Program, and can be reasonably considered independent and separate works in themselves, then this License, and its terms, do not apply to those sections when you distribute them as separate works. But when you distribute the same sections as part of a whole which is a work based on the Program, the distribution of the whole must be on the terms of this License, whose permissions for other licensees extend to the entire whole, and thus to each and every part regardless of who wrote it. Thus, it is not the intent of this section to claim rights or contest your rights to work written entirely by you; rather, the intent is to exercise the right to control the distribution of derivative or

collective works based on the Program. In addition, mere aggregation of another work not based on the Program with the Program (or with a work based on the Program) on a volume of a storage or distribution medium does not bring the other work under the scope of this License.

3. You may copy and distribute the Program (or a work based on it, under Section 2) in object code or executable form under the terms of Sections 1 and 2 above provided that you also do one of the following:

a) Accompany it with the complete corresponding machine-readable source code, which must be distributed under the terms of Sections 1 and 2 above on a medium customarily used for software interchange; or, b) Accompany it with a written offer, valid for at least three years, to give any third party, for a charge no more than your cost of physically performing source distribution, a complete machine-readable copy of the corresponding source code, to be distributed under the terms of Sections 1 and 2 above on a medium customarily used for software interchange; or, c) Accompany it with the information you received as to the offer to distribute corresponding source code. (This alternative is allowed only for noncommercial distribution and only if you received the program in object code or executable form with such an offer, in accord with Subsection b above.) The source code for a work means the preferred form of the work for making modifications to it. For an executable work, complete source code means all the source code for all modules it contains, plus any associated interface definition files, plus the scripts used to control compilation and installation of the executable. However, as a special exception, the source code distributed need not include anything that is normally distributed (in either source or binary form) with the major components (compiler, kernel, and so on) of the operating system on which the executable runs, unless that component itself accompanies the executable. If distribution of executable or object code is made by offering access to copy from a designated place, then offering equivalent access to copy the source code from the same place counts as distribution of the source code, even though third parties are not compelled to copy the source along with the object code.

4. You may not copy, modify, sublicense, or distribute the Program except as expressly provided under this License. Any attempt otherwise to copy, modify, sublicense or distribute the Program is void, and will automatically terminate your rights under this License. However, parties who have received copies, or rights, from you under this License will not have their licenses terminated so long as such parties remain in full compliance.

5. You are not required to accept this License, since you have not signed it. However, nothing else grants you permission to modify or distribute the Program or its derivative works. These actions are prohibited by law if you do not accept this License. Therefore, by modifying or distributing the Program (or any work based on the Program), you indicate your acceptance of this License to do so, and all its terms and conditions for copying, distributing or modifying the Program or works based on it.

6. Each time you redistribute the Program (or any work based on the Program), the recipient automatically receives a license from the original licensor to copy, distribute or modify the Program subject to these terms and conditions. You may not impose any further

restrictions on the recipients' exercise of the rights granted herein. You are not responsible for enforcing compliance by third parties to this License.

7. If, as a consequence of a court judgment or allegation of patent infringement or for any other reason (not limited to patent issues), conditions are imposed on you (whether by court order, agreement or otherwise) that contradict the conditions of this License, they do not excuse you from the conditions of this License. If you cannot distribute so as to satisfy simultaneously your obligations under this License and any other pertinent obligations, then as a consequence you may not distribute the Program at all. For example, if a patent license would not permit royalty-free redistribution of the Program by all those who receive copies directly or indirectly through you, then the only way you could satisfy both it and this License would be to refrain entirely from distribution of the Program. If any portion of this section is held invalid or unenforceable under any particular circumstance, the balance of the section is intended to apply and the section as a whole is intended to apply in other circumstances. It is not the purpose of this section to induce you to infringe any patents or other property right claims or to contest validity of any such claims; this section has the sole purpose of protecting the integrity of the free software distribution system, which is implemented by public license practices. Many people have made generous contributions to the wide range of software distributed through that system in reliance on consistent application of that system; it is up to the author/donor to decide if he or she is willing to distribute software through any other system and a licensee cannot impose that choice.

This section is intended to make thoroughly clear what is believed to be a consequence of the rest of this License.

8. If the distribution and/or use of the Program is restricted in certain countries either by patents or by copyrighted interfaces, the original copyright holder who places the Program under this License may add an explicit geographical distribution limitation excluding those countries, so that distribution is permitted only in or among countries not thus excluded. In such case, this License incorporates the limitation as if written in the body of this License.

9. The Free Software Foundation may publish revised and/or new versions of the General Public License from time to time. Such new versions will be similar in spirit to the present version, but may differ in detail to address new problems or concerns. Each version is given a distinguishing version number. If the Program specifies a version number of this License which applies to it and "any later version", you have the option of following the terms and conditions either of that version or of any later version published by the Free Software Foundation. If the Program does not specify a version number of this License, you may choose any version ever published by the Free Software Foundation.

10. If you wish to incorporate parts of the Program into other free programs whose distribution conditions are different, write to the author to ask for permission. For software which is copyrighted by the Free Software Foundation, write to the Free Software Foundation; we sometimes make exceptions for this. Our decision will be guided by the two

goals of preserving the free status of all derivatives of our free software and of promoting the sharing and reuse of software generally.

NO WARRANTY

11. BECAUSE THE PROGRAM IS LICENSED FREE OF CHARGE, THERE IS NO WARRANTY FOR THE PROGRAM, TO THE EXTENT PERMITTED BY APPLICABLE LAW. EXCEPT WHEN OTHERWISE STATED IN WRITING THE COPYRIGHT HOLDERS AND/OR OTHER PARTIES PROVIDE THE PROGRAM "AS IS" WITHOUT WARRANTY OF ANY KIND, EITHER EXPRESSED OR IMPLIED, INCLUDING, BUT NOT LIMITED TO, THE IMPLIED WARRANTIES OF MERCHANTABILITY AND FITNESS FOR A PARTICULAR PURPOSE. THE ENTIRE RISK AS TO THE QUALITY AND PERFORMANCE OF THE PROGRAM IS WITH YOU. SHOULD THE PROGRAM PROVE DEFECTIVE, YOU ASSUME THE COST OF ALL NECESSARY SERVICING, REPAIR OR CORRECTION.

12. IN NO EVENT UNLESS REQUIRED BY APPLICABLE LAW OR AGREED TO IN WRITING WILL ANY COPYRIGHT HOLDER, OR ANY OTHER PARTY WHO MAY MODIFY AND/OR REDISTRIBUTE THE PROGRAM AS PERMITTED ABOVE, BE LIABLE TO YOU FOR DAMAGES, INCLUDING ANY GENERAL, SPECIAL, INCIDENTAL OR CONSEQUENTIAL DAMAGES ARISING OUT OF THE USE OR INABILITY TO USE THE PROGRAM (INCLUDING BUT NOT LIMITED TO LOSS OF DATA OR DATA BEING RENDERED INACCURATE OR LOSSES SUSTAINED BY YOU OR THIRD PARTIES OR A FAILURE OF THE PROGRAM TO OPERATE WITH ANY OTHER PROGRAMS), EVEN IF SUCH HOLDER OR OTHER PARTY HAS BEEN ADVISED OF THE POSSIBILITY OF SUCH DAMAGES.

END OF TERMS AND CONDITIONS

How to Apply These Terms to Your New Programs

If you develop a new program, and you want it to be of the greatest possible use to the public, the best way to achieve this is to make it free software which everyone can redistribute and change under these terms. To do so, attach the following notices to the program. It is safest to attach them to the start of each source file to most effectively convey the exclusion of warranty; and each file should have at least the "copyright" line and a pointer to where the full notice is found.

<one line to give the program's name and a brief idea of what it does.>
Copyright © <year> <name of author>

This program is free software; you can redistribute it and/or modify it under the terms of the GNU General Public License as published by the Free Software Foundation; either version 2 of the License, or (at your option) any later version. This program is distributed in the hope that it will be useful, but WITHOUT ANY WARRANTY; without even the implied

warranty of MERCHANTABILITY or FITNESS FOR A PARTICULAR PURPOSE. See the GNU General Public License for more details. You should have received a copy of the GNU General Public License along with this program; if not, write to the Free Software Foundation, Inc., 51 Franklin St, Fifth Floor, Boston, MA 02110-1301 USA Also add information on how to contact you by electronic and paper mail.

If the program is interactive, make it output a short notice like this when it starts in an interactive mode:

Gnomovision version 69, Copyright © year name of author Gnomovision comes with ABSOLUTELY NO WARRANTY; for details type `show w'. This is free software, and you are welcome to redistribute it under certain conditions; type `show c' for details. The hypothetical commands `show w' and `show c' should show the appropriate parts of the General Public License. Of course, the commands you use may be called something other than `show w' and `show c'; they could even be mouse-clicks or menu items-- whatever suits your program. You should also get your employer (if you work as a programmer) or your school, if any, to sign a "copyright disclaimer" for the program, if necessary. Here is a sample; alter the names:

Yoyodyne, Inc., hereby disclaims all copyright interest in the program `Gnomovision' (which makes passes at compilers)
written by James Hacker.
<signature of Ty Coon>, 1 April 1989
Ty Coon, President of Vice

This General Public License does not permit incorporating your program into proprietary programs. If your program is a subroutine library, you may consider it more useful to permit linking proprietary applications with the library. If this is what you want to do, use the GNU Library General Public License instead of this License.

GNU LESSER GENERAL PUBLIC LICENSE

Version 2.1, February 1999

Copyright © 1991, 1999 Free Software Foundation, Inc. 51 Franklin St, Fifth Floor, Boston, MA 02110-1301 USA

Everyone is permitted to copy and distribute verbatim copies of this license document, but changing it is not allowed. [This is the first released version of the Lesser GPL. It also counts as the successor of the GNU Library Public License, version 2, hence the version number 2.1.]

Preamble

The licenses for most software are designed to take away your freedom to share and change it. By contrast, the GNU General Public Licenses are intended to guarantee your freedom to share and change free software--to make sure the software is free for all its users. This license, the Lesser General Public License, applies to some specially designated software packages--typically libraries--of the Free Software Foundation and other authors who decide to use it. You can use it too, but we suggest you first think carefully about whether this license or the ordinary General Public License is the better strategy to use in any particular case, based on the explanations below. When we speak of free software, we are referring to freedom of use, not price. Our General Public Licenses are designed to make sure that you have the freedom to distribute copies of free software (and charge for this service if you wish); that you receive source code or can get it if you want it; that you can change the software and use pieces of it in new free programs; and that you are informed that you can do these things.

To protect your rights, we need to make restrictions that forbid distributors to deny you these rights or to ask you to surrender these rights. These restrictions translate to certain responsibilities for you if you distribute copies of the library or if you modify it. For example, if you distribute copies of the library, whether gratis or for a fee, you must give the recipients all the rights that we gave you. You must make sure that they, too, receive or can get the source code. If you link other code with the library, you must provide complete object files to the recipients, so that they can relink them with the library after making changes to the library and recompiling it. And you must show them these terms so they know their rights. We protect your rights with a two-step method: (1) we copyright the library, and (2) we offer you this license, which gives you legal permission to copy, distribute and/or modify the library.

To protect each distributor, we want to make it very clear that there is no warranty for the free library. Also, if the library is modified by someone else and passed on, the recipients should know that what they have is not the original version, so that the original author's reputation will not be affected by problems that might be introduced by others. Finally,

software patents pose a constant threat to the existence of any free program. We wish to make sure that a company cannot effectively restrict the users of a free program by obtaining a restrictive license from a patent holder. Therefore, we insist that any patent license obtained for a version of the library must be consistent with the full freedom of use specified in this license. Most GNU software, including some libraries, is covered by the ordinary GNU General Public License.

This license, the GNU Lesser General Public License, applies to certain designated libraries, and is quite different from the ordinary General Public License. We use this license for certain libraries in order to permit linking those libraries into non-free programs. When a program is linked with a library, whether statically or using a shared library, the combination of the two is legally speaking a combined work, a derivative of the original library. The ordinary General Public License therefore permits such linking only if the entire combination fits its criteria of freedom. The Lesser General Public License permits more lax criteria for linking other code with the library. We call this license the "Lesser" General Public License because it does Less to protect the user's freedom than the ordinary General Public License. It also provides other free software developers Less of an advantage over competing nonfree programs. These disadvantages are the reason we use the ordinary General Public License for many libraries. However, the Lesser license provides advantages in certain special circumstances.

For example, on rare occasions, there may be a special need to encourage the widest possible use of a certain library, so that it becomes a de-facto standard. To achieve this, non-free programs must be allowed to use the library. A more frequent case is that a free library does the same job as widely used non-free libraries. In this case, there is little to gain by limiting the free library to free software only, so we use the Lesser General Public License. In other cases, permission to use a particular library in nonfree programs enables a greater number of people to use a large body of free software. For example, permission to use the GNU C Library in non-free programs enables many more people to use the whole GNU operating system, as well as its variant, the GNU/Linux operating system.

Although the Lesser General Public License is Less protective of the users' freedom, it does ensure that the user of a program that is linked with the Library has the freedom and the wherewithal to run that program using a modified version of the Library. The precise terms and conditions for copying, distribution and modification follow. Pay close attention to the difference between a "work based on the library" and a "work that uses the library". The former contains code derived from the library, whereas the latter must be combined with the library in order to run.

GNU LESSER GENERAL PUBLIC LICENSE TERMS AND CONDITIONS FOR COPYING, DISTRIBUTION AND MODIFICATION

0. This License Agreement applies to any software library or other program which contains a notice placed by the copyright holder or other authorized party saying it may be distributed under the terms of this Lesser General Public License (also called "this License"). Each licensee is addressed as "you". A "library" means a collection of software functions and/or data prepared so as to be conveniently linked with application programs (which use some of those functions and data) to form executables. The "Library", below, refers to any such software library or work which has been distributed under these terms. A "work based on the Library" means either the Library or any derivative work under copyright law: that is to say, a work containing the Library or a portion of it, either verbatim or with modifications and/or translated straightforwardly into another language. (Hereinafter, translation is included without limitation in the term "modification".) "Source code" for a work means the preferred form of the work for making modifications to it. For a library, complete source code means all the source code for all modules it contains, plus any associated interface definition files, plus the scripts used to control compilation and installation of the library. Activities other than copying, distribution and modification are not covered by this License; they are outside its scope. The act of running a program using the Library is not restricted, and output from such a program is covered only if its contents constitute a work based on the Library (independent of the use of the Library in a tool for writing it). Whether that is true depends on what the Library does and what the program that uses the Library does.

1. You may copy and distribute verbatim copies of the Library's complete source code as you receive it, in any medium, provided that you conspicuously and appropriately publish on each copy an appropriate copyright notice and disclaimer of warranty; keep intact all the notices that refer to this License and to the absence of any warranty; and distribute a copy of this License along with the Library. You may charge a fee for the physical act of transferring a copy, and you may at your option offer warranty protection in exchange for a fee.

2. You may modify your copy or copies of the Library or any portion of it, thus forming a work based on the Library, and copy and distribute such modifications or work under the terms of Section 1 above, provided that you also meet all of these conditions: a) The modified work must itself be a software library. b) You must cause the files modified to carry prominent notices stating that you changed the files and the date of any change. c) You must cause the whole of the work to be licensed at no charge to all third parties under the terms of this License. d) If a facility in the modified Library refers to a function or a table of data to be supplied by an application program that uses the facility, other than as an argument passed when the facility is invoked, then you must make a good faith effort to ensure that, in the event an application does not supply such function or table, the facility

still operates, and performs whatever part of its purpose remains meaningful. (For example, a function in a library to compute square roots has a purpose that is entirely well-defined independent of the application. Therefore, Subsection 2d requires that any application-supplied function or table used by this function must be optional: if the application does not supply it, the square root function must still compute square roots.) These requirements apply to the modified work as a whole. If identifiable sections of that work are not derived from the Library, and can be reasonably considered independent and separate works in themselves, then this License, and its terms, do not apply to those sections when you distribute them as separate works. But when you distribute the same sections as part of a whole which is a work based on the Library, the distribution of the whole must be on the terms of this License, whose permissions for other licensees extend to the entire whole, and thus to each and every part regardless of who wrote it. Thus, it is not the intent of this section to claim rights or contest your rights to work written entirely by you; rather, the intent is to exercise the right to control the distribution of derivative or collective works based on the Library. In addition, mere aggregation of another work not based on the Library with the Library (or with a work based on the Library) on a volume of a storage or distribution medium does not bring the other work under the scope of this License.

3. You may opt to apply the terms of the ordinary GNU General Public License instead of this License to a given copy of the Library. To do this, you must alter all the notices that refer to this License, so that they refer to the ordinary GNU General Public License, version 2, instead of to this License. (If a newer version than version 2 of the ordinary GNU General Public License has appeared, then you can specify that version instead if you wish.) Do not make any other change in these notices. Once this change is made in a given copy, it is irreversible for that copy, so the ordinary GNU General Public License applies to all subsequent copies and derivative works made from that copy. This option is useful when you wish to copy part of the code of the Library into a program that is not a library.

4. You may copy and distribute the Library (or a portion or derivative of it, under Section 2) in object code or executable form under the terms of Sections 1 and 2 above provided that you accompany it with the complete corresponding machinereadable source code, which must be distributed under the terms of Sections 1 and 2 above on a medium customarily used for software interchange. If distribution of object code is made by offering access to copy from a designated place, then offering equivalent access to copy the source code from the same place satisfies the requirement to distribute the source code, even though third parties are not compelled to copy the source along with the object code.

5. A program that contains no derivative of any portion of the Library, but is designed to work with the Library by being compiled or linked with it, is called a "work that uses the Library". Such a work, in isolation, is not a derivative work of the Library, and therefore falls outside the scope of this License. However, linking a "work that uses the Library" with the Library creates an executable that is a derivative of the Library (because it contains portions of the Library), rather than a "work that uses the library". The executable is therefore covered by this License. Section 6 states terms for distribution of such executables. When

a "work that uses the Library" uses material from a header file that is part of the Library, the object code for the work may be a derivative work of the Library even though the source code is not. Whether this is true is especially significant if the work can be linked without the Library, or if the work is itself a library. The threshold for this to be true is not precisely defined by law. If such an object file uses only numerical parameters, data structure layouts and accessors, and small macros and small inline functions (ten lines or less in length), then the use of the object file is unrestricted, regardless of whether it is legally a derivative work. (Executables containing this object code plus portions of the Library will still fall under Section 6.) Otherwise, if the work is a derivative of the Library, you may distribute the object code for the work under the terms of Section 6. Any executables containing that work also fall under Section 6, whether or not they are linked directly with the Library itself.

6. As an exception to the Sections above, you may also combine or link a "work that uses the Library" with the Library to produce a work containing portions of the Library, and distribute that work under terms of your choice, provided that the terms permit modification of the work for the customer's own use and reverse engineering for debugging such modifications. You must give prominent notice with each copy of the work that the Library is used in it and that the Library and its use are covered by this License. You must supply a copy of this License. If the work during execution displays copyright notices, you must include the copyright notice for the Library among them, as well as a reference directing the user to the copy of this License. Also, you must do one of these things: a) Accompany the work with the complete corresponding machine-readable source code for the Library including whatever changes were used in the work (which must be distributed under Sections 1 and 2 above); and, if the work is an executable linked with the Library, with the complete machine-readable "work that uses the Library", as object code and/or source code, so that the user can modify the Library and then relink to produce a modified executable containing the modified Library. (It is understood that the user who changes the contents of definitions files in the Library will not necessarily be able to recompile the application to use the modified definitions.) b) Use a suitable shared library mechanism for linking with the Library. A suitable mechanism is one that (1) uses at run time a copy of the library already present on the user's computer system, rather than copying library functions into the executable, and (2) will operate properly with a modified version of the library, if the user installs one, as long as the modified version is interface-compatible with the version that the work was made with. c) Accompany the work with a written offer, valid for at least three years, to give the same user the materials specified in Subsection 6a, above, for a charge no more than the cost of performing this distribution. d) If distribution of the work is made by offering access to copy from a designated place, offer equivalent access to copy the above specified materials from the same place. e) Verify that the user has already received a copy of these materials or that you have already sent this user a copy. For an executable, the required form of the "work that uses the Library" must include any data and utility programs needed for reproducing the executable from it. However, as a special exception, the materials to be distributed need not include anything that is normally distributed (in

either source or binary form) with the major components (compiler, kernel, and so on) of the operating system on which the executable runs, unless that component itself accompanies the executable. It may happen that this requirement contradicts the license restrictions of other proprietary libraries that do not normally accompany the operating system. Such a contradiction means you cannot use both them and the Library together in an executable that you distribute.

7. You may place library facilities that are a work based on the Library side-by-side in a single library together with other library facilities not covered by this License, and distribute such a combined library, provided that the separate distribution of the work based on the Library and of the other library facilities is otherwise permitted, and provided that you do these two things: a) Accompany the combined library with a copy of the same work based on the Library, uncombined with any other library facilities. This must be distributed under the terms of the Sections above. b) Give prominent notice with the combined library of the fact that part of it is a work based on the Library, and explaining where to find the accompanying uncombined form of the same work.

8. You may not copy, modify, sublicense, link with, or distribute the Library except as expressly provided under this License. Any attempt otherwise to copy, modify, sublicense, link with, or distribute the Library is void, and will automatically terminate your rights under this License. However, parties who have received copies, or rights, from you under this License will not have their licenses terminated so long as such parties remain in full compliance.

9. You are not required to accept this License, since you have not signed it. However, nothing else grants you permission to modify or distribute the Library or its derivative works. These actions are prohibited by law if you do not accept this License. Therefore, by modifying or distributing the Library (or any work based on the Library), you indicate your acceptance of this License to do so, and all its terms and conditions for copying, distributing or modifying the Library or works based on it.

10. Each time you redistribute the Library (or any work based on the Library), the recipient automatically receives a license from the original licensor to copy, distribute, link with or modify the Library subject to these terms and conditions. You may not impose any further restrictions on the recipients' exercise of the rights granted herein. You are not responsible for enforcing compliance by third parties with this License.

11. If, as a consequence of a court judgment or allegation of patent infringement or for any other reason (not limited to patent issues), conditions are imposed on you (whether by court order, agreement or otherwise) that contradict the conditions of this License, they do not excuse you from the conditions of this License. If you cannot distribute so as to satisfy simultaneously your obligations under this License and any other pertinent obligations, then as a consequence you may not distribute the Library at all. For example, if a patent license would not permit royalty-free redistribution of the Library by all those who receive copies directly or indirectly through you, then the only way you could satisfy both it and this License would be to refrain entirely from distribution of the Library. If any portion of this

section is held invalid or unenforceable under any particular circumstance, the balance of the section is intended to apply, and the section as a whole is intended to apply in other circumstances. It is not the purpose of this section to induce you to infringe any patents or other property right claims or to contest validity of any such claims; this section has the sole purpose of protecting the integrity of the free software distribution system which is implemented by public license practices. Many people have made generous contributions to the wide range of software distributed through that system in reliance on consistent application of that system; it is up to the author/donor to decide if he or she is willing to distribute software through any other system and a licensee cannot impose that choice. This section is intended to make thoroughly clear what is believed to be a consequence of the rest of this License.

12. If the distribution and/or use of the Library is restricted in certain countries either by patents or by copyrighted interfaces, the original copyright holder who places the Library under this License may add an explicit geographical distribution limitation excluding those countries, so that distribution is permitted only in or among countries not thus excluded. In such case, this License incorporates the limitation as if written in the body of this License.

13. The Free Software Foundation may publish revised and/or new versions of the Lesser General Public License from time to time. Such new versions will be similar in spirit to the present version, but may differ in detail to address new problems or concerns. Each version is given a distinguishing version number. If the Library specifies a version number of this License which applies to it and "any later version", you have the option of following the terms and conditions either of that version or of any later version published by the Free Software Foundation. If the Library does not specify a license version number, you may choose any version ever published by the Free Software Foundation.

14. If you wish to incorporate parts of the Library into other free programs whose distribution conditions are incompatible with these, write to the author to ask for permission. For software which is copyrighted by the Free Software Foundation, write to the Free Software Foundation; we sometimes make exceptions for this. Our decision will be guided by the two goals of preserving the free status of all derivatives of our free software and of promoting the sharing and reuse of software generally.

NO WARRANTY

15. BECAUSE THE LIBRARY IS LICENSED FREE OF CHARGE, THERE IS NO WARRANTY FOR THE LIBRARY, TO THE EXTENT PERMITTED BY APPLICABLE LAW. EXCEPT WHEN OTHERWISE STATED IN WRITING THE COPYRIGHT HOLDERS AND/OR OTHER PARTIES PROVIDE THE LIBRARY "AS IS" WITHOUT WARRANTY OF ANY KIND, EITHER EXPRESSED OR IMPLIED, INCLUDING, BUT NOT LIMITED TO, THE IMPLIED WARRANTIES OF MERCHANTABILITY AND FITNESS FOR A PARTICULAR PURPOSE. THE ENTIRE RISK AS TO THE QUALITY AND PERFORMANCE OF THE LIBRARY IS WITH YOU. SHOULD THE LIBRARY PROVE DEFECTIVE, YOU ASSUME THE COST OF ALL NECESSARY SERVICING, REPAIR OR CORRECTION.

16. IN NO EVENT UNLESS REQUIRED BY APPLICABLE LAW OR AGREED TO IN WRITING WILL ANY COPYRIGHT HOLDER, OR ANY OTHER PARTY WHO MAY MODIFY AND/OR REDISTRIBUTE THE LIBRARY AS PERMITTED ABOVE, BE LIABLE TO YOU FOR DAMAGES, INCLUDING ANY GENERAL, SPECIAL, INCIDENTAL OR CONSEQUENTIAL DAMAGES ARISING OUT OF THE USE OR INABILITY TO USE THE LIBRARY (INCLUDING BUT NOT LIMITED TO LOSS OF DATA OR DATA BEING RENDERED INACCURATE OR LOSSES SUSTAINED BY YOU OR THIRD PARTIES OR A FAILURE OF THE LIBRARY TO OPERATE WITH ANY OTHER SOFTWARE), EVEN IF SUCH HOLDER OR OTHER PARTY HAS BEEN ADVISED OF THE POSSIBILITY OF SUCH DAMAGES.

END OF TERMS AND CONDITIONS

How to Apply These Terms to Your New Libraries

If you develop a new library, and you want it to be of the greatest possible use to the public, we recommend making it free software that everyone can redistribute and change. You can do so by permitting redistribution under these terms (or, alternatively, under the terms of the ordinary General Public License). To apply these terms, attach the following notices to the library. It is safest to attach them to the start of each source file to most effectively convey the exclusion of warranty; and each file should have at least the "copyright" line and a pointer to where the full notice is found. <one line to give the library's name and a brief idea of what it does.> Copyright © <year> <name of author>

This library is free software; you can redistribute it and/or modify it under the terms of the GNU Lesser General Public License as published by the Free Software Foundation; either version 2.1 of the License, or (at your option) any later version. This library is distributed in the hope that it will be useful, but WITHOUT ANY WARRANTY; without even the implied warranty of MERCHANTABILITY or FITNESS FOR A PARTICULAR PURPOSE. See the GNU Lesser General Public License for more details. You should have received a copy of the GNU

Lesser General Public License along with this library; if not, write to the Free Software Foundation, Inc., 51 Franklin St, Fifth Floor, Boston, MA 02110-1301 USA. Also add information on how to contact you by electronic and paper mail. You should also get your employer (if you work as a programmer) or your school, if any, to sign a "copyright disclaimer" for the library, if necessary. Here is a sample; alter the names:

Yoyodyne, Inc., hereby disclaims all copyright interest in the library `Frob' (a library for tweaking knobs) written by James Random Hacker.

<signature of Ty Coon>, 1 April 1990
Ty Coon, President of Vice

That's all there is to it!

GNU ABOUT THE OpenSSL TOOLKIT

This product includes software developed by the OpenSSL Project for use in the OpenSSL Toolkit (<http://www.openssl.org/>). Copyright© 1998-2008 The OpenSSL Project. All rights reserved.

THIS SOFTWARE IS PROVIDED BY THE OpenSSL PROJECT "AS IS" AND ANY EXPRESSED OR IMPLIED WARRANTIES, INCLUDING, BUT NOT LIMITED TO, THE IMPLIED WARRANTIES OF MERCHANTABILITY AND FITNESS FOR A PARTICULAR PURPOSE ARE DISCLAIMED. IN NO EVENT SHALL THE OpenSSL PROJECT OR ITS CONTRIBUTORS BE LIABLE FOR ANY DIRECT, INDIRECT, INCIDENTAL, SPECIAL, EXEMPLARY, OR CONSEQUENTIAL DAMAGES (INCLUDING, BUT NOT LIMITED TO, PROCUREMENT OF SUBSTITUTE GOODS OR SERVICES; LOSS OF USE, DATA, OR PROFITS; OR BUSINESS INTERRUPTION) HOWEVER CAUSED AND ON ANY THEORY OF LIABILITY, WHETHER IN CONTRACT, STRICT LIABILITY, OR TORT (INCLUDING NEGLIGENCE OR OTHERWISE) ARISING IN ANY WAY OUT OF THE USE OF THIS SOFTWARE, EVEN IF ADVISED OF THE POSSIBILITY OF SUCH DAMAGE.

This product includes cryptographic software written by Eric Young (eay@cryptsoft.com). Copyright (C) 1995-1998 Eric Young (eay@cryptsoft.com) All rights reserved.

THIS SOFTWARE IS PROVIDED BY ERIC YOUNG "AS IS" AND ANY EXPRESS OR IMPLIED WARRANTIES, INCLUDING, BUT NOT LIMITED TO, THE IMPLIED WARRANTIES OF MERCHANTABILITY AND FITNESS FOR A PARTICULAR PURPOSE ARE DISCLAIMED. IN NO EVENT SHALL THE AUTHOR OR CONTRIBUTORS BE LIABLE FOR ANY DIRECT, INDIRECT, INCIDENTAL, SPECIAL, EXEMPLARY, OR CONSEQUENTIAL DAMAGES (INCLUDING, BUT NOT LIMITED TO, PROCUREMENT OF SUBSTITUTE GOODS OR SERVICES; LOSS OF USE, DATA, OR PROFITS; OR BUSINESS INTERRUPTION) HOWEVER CAUSED AND ON ANY THEORY OF LIABILITY, WHETHER IN CONTRACT, STRICT LIABILITY, OR TORT (INCLUDING NEGLIGENCE OR OTHERWISE) ARISING IN ANY WAY OUT OF THE USE OF THIS SOFTWARE, EVEN IF ADVISED OF THE POSSIBILITY OF SUCH DAMAGE.

This product includes software written by Tim Hudson (tjh@cryptsoft.com).

InFocus

InFocus Corporation

13190 SW 68th Parkway
Suite 200
Portland, OR 97223-8368
Phone: 503.207.4700
Toll Free: 877.388.8385
Fax: 503.207.1937
▶ www.infocus.com



QR82892

Printed in China