



Maintenance and Service Guide

HP 280 G2 Microtower Business PC
HP 285 G2 Microtower Business PC

© Copyright 2016 HP Development Company, L.P.

AMD is a trademark of Advanced Micro Devices, Inc. Bluetooth is a trademark owned by its proprietor and used by Hewlett-Packard Company under license. Intel, Celeron, and Pentium are trademarks of Intel Corporation in the U.S. and other countries. Microsoft and Windows are trademarks of the Microsoft group of companies.

The information contained herein is subject to change without notice. The only warranties for HP products and services are set forth in the express warranty statements accompanying such products and services. Nothing herein should be construed as constituting an additional warranty. HP shall not be liable for technical or editorial errors or omissions contained herein.

First Edition (February 2016)

Document Part Number: 854096-001

Product notice

This user guide describes features that are common to most models. Some features may not be available on your computer.

Not all features are available in all editions of Windows. This computer may require upgraded and/or separately purchased hardware, drivers and/or software to take full advantage of Windows functionality. Go to <http://www.microsoft.com> for details.

Software terms

By installing, copying, downloading, or otherwise using any software product preinstalled on this computer, you agree to be bound by the terms of the HP End User License Agreement (EULA). If you do not accept these license terms, your sole remedy is to return the entire unused product (hardware and software) within 14 days for a full refund subject to the refund policy of your seller.

For any further information or to request a full refund of the price of the computer, please contact your seller.

Safety warning notice

 **WARNING!** To reduce the possibility of heat-related injuries or of overheating the device, do not place the device directly on your lap or obstruct the device air vents. Use the device only on a hard, flat surface. Do not allow another hard surface, such as an adjoining optional printer, or a soft surface, such as pillows or rugs or clothing, to block airflow. Also, do not allow the AC adapter to contact the skin or a soft surface, such as pillows or rugs or clothing, during operation. The device and the AC adapter comply with the user-accessible surface temperature limits defined by the International Standard for Safety of Information Technology Equipment (IEC 60950).

Table of contents

1 Product features	1
Standard configuration features	1
Front panel components	2
Rear panel components	3
Serial number location	3
2 Illustrated parts catalog	4
Microtower (MT) chassis spare parts	4
Computer major components	4
Misc parts	6
Misc boards	8
Drives	8
3 Routine care, SATA drive guidelines, and disassembly preparation	9
Electrostatic discharge information	9
Generating static	9
Preventing electrostatic damage to equipment	10
Personal grounding methods and equipment	10
Grounding the work area	10
Recommended materials and equipment	11
Operating guidelines	11
Routine care	12
General cleaning safety precautions	12
Cleaning the Computer Case	12
Cleaning the keyboard	12
Cleaning the monitor	13
Cleaning the mouse	13
Service considerations	13
Power supply fan	13
Tools and software Requirements	13
Screws	14
Cables and connectors	14
Hard Drives	14
Lithium coin cell battery	14
SATA hard drives	15
SATA hard drive cables	15

SATA data cable	15
SMART ATA drives	15
Cable management	16
4 Removal and replacement procedures – Microtower (MT) chassis	17
Preparation for disassembly	17
Access panel	18
Front bezel	19
Front bezel security	20
Slim optical drive bezel blank	21
Memory	22
DIMMs	22
DIMM specifications	22
Populating DIMM sockets	22
Installing DIMMs	23
Expansion cards	25
Drives	28
Drive positions	29
Removing a 9.5 mm slim optical drive	30
Installing a 9.5 mm slim optical drive	31
Removing a hard drive	33
Installing a hard drive	34
Front I/O and power switch assembly	37
Speaker	39
Rear chassis fan	40
Power supply	41
Fan sink	44
Processor for use in HP 280 G2 models (Intel)	45
Processor for use in HP 285 G2 models (AMD)	46
System board	47
System board callouts – HP 280 Pro G2 Microtower models	48
System board callouts – HP 280 G2 Microtower models	49
System board callouts – HP 285 G2 Microtower models	50
5 Computer Setup (F10) Utility	51
Computer Setup (F10) Utilities	51
Using Computer Setup (F10) Utilities	52
Computer Setup—File	53
Computer Setup—Storage	54
Computer Setup—Security	55
Computer Setup—Power	57

Computer Setup—Advanced	57
Recovering the Configuration Settings	58
6 Troubleshooting without diagnostics	59
Safety and comfort	59
Before you call for technical support	59
Helpful hints	60
Solving general problems	61
Solving power problems	65
Solving hard drive problems	66
Solving media card reader problems	68
Solving display problems	69
Solving audio problems	73
Solving printer problems	75
Solving keyboard and mouse problems	76
Solving hardware installation problems	78
Solving network problems	79
Solving memory problems	82
Solving CD-ROM and DVD problems	83
Solving USB flash drive problems	85
Solving front panel component problems	86
Solving Internet access problems	87
Solving software problems	88
7 POST error messages and diagnostic front panel LEDs and audible codes	89
POST numeric codes and text messages	89
Interpreting system validation diagnostic front panel LEDs and audible codes	94
8 Password security and resetting CMOS	96
Resetting the password jumper	96
Changing a Setup or Power-On password	97
Deleting a Setup or Power-On password	98
9 Using HP PC Hardware Diagnostics (UEFI)	99
Downloading HP PC Hardware Diagnostics (UEFI) to a USB device	99
10 System backup and recovery	101
Backing up, restoring, and recovering in Windows 10	101
Creating recovery media and backups	101
Creating HP Recovery media (select products only)	101

Using Windows tools	102
Restore and recovery	102
Recovering using HP Recovery Manager	103
What you need to know before you get started	103
Using the HP Recovery partition (select products only)	104
Using HP Recovery media to recover	104
Changing the computer boot order	104
Removing the HP Recovery partition (select products only)	104
Backing up, restoring, and recovering in Windows 7	105
Creating recovery media	105
Creating recovery media using HP Recovery Manager (select models only)	106
Creating recovery discs with HP Recovery Disc Creator (select models only)	107
Creating recovery discs	107
Backing up your information	107
System Restore	108
System Recovery	108
System Recovery when Windows is responding	109
System Recovery when Windows is not responding	109
System Recovery using recovery media (select models only)	110
Using HP Recovery Disc operating system discs (select models only)	110
Appendix A Battery replacement	112
Appendix B Power Cord Set Requirements	115
General Requirements	115
Japanese Power Cord Requirements	115
Country-Specific Requirements	116
Appendix C Statement of Volatility	117
Appendix D Specifications	119
MT Specifications	119
Index	120

1 Product features

Standard configuration features

Features may vary depending on the model. For support assistance and to learn more about the hardware and software installed on your computer model, run the HP Support Assistant utility.



Front panel components

Drive configuration may vary by model. Some models have a bezel blank covering the optical drive bay.

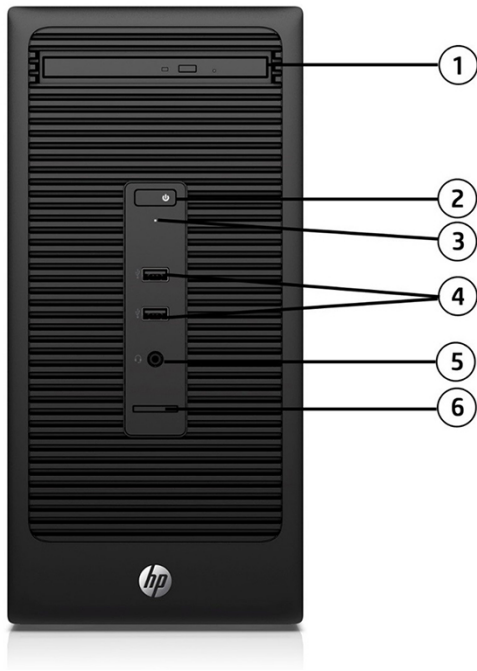

Item	Component	Item	Component
1	Slim Optical Drive (optional)	4	USB 2.0 Ports (2)
2	Dual-State Power Button	5	Microphone/Headphone Connector
3	Status LED	6	SD Card Reader (optional)

NOTE: When a device is plugged into the Microphone/Headphone Connector, a dialog box will pop up asking if you want to use the connector for a microphone Line-In device or a headphone. You can reconfigure the connector at any time by double-clicking the Audio Manager icon in the Windows taskbar.

NOTE: The Power On Light is normally white when the power is on. If it is flashing red, there is a problem with the computer and it is displaying a diagnostic code.

Rear panel components

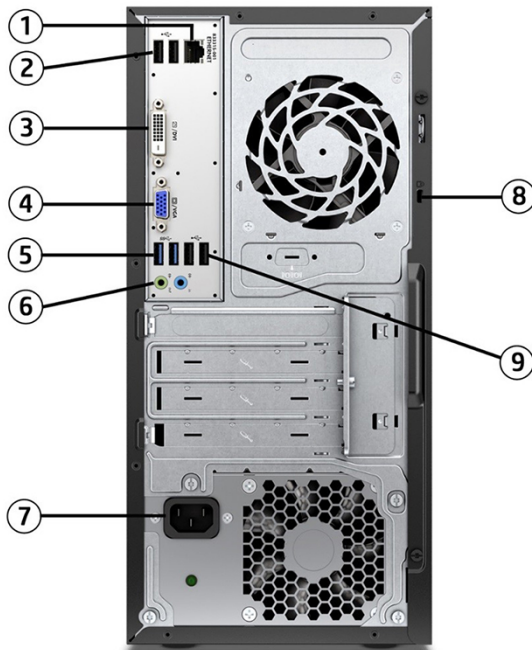

Item	Component	Item	Component
1	RJ-45 Network Connector	6	Line-In Audio Connector (blue); Line-In Audio Connector (blue)
2	USB 2.0 Ports (2)	7	Power Cord Connector
3	DVI-D Monitor Connector	8	Security Lock Slot
4	VGA Monitor Connector	9	USB 2.0 Ports (2)
5	USB 3.0 Ports (2)		

NOTE: An optional second serial port and an optional parallel port are available from HP.

When a device is plugged into the blue Line-In Audio Connector, a dialog box will pop up asking if you want to use the connector for a line-in device or a microphone. You can reconfigure the connector at any time by double-clicking the Audio Manager icon in the Windows taskbar.

When a graphics card is installed in one of the system board slots, the video connectors on the graphics card and/or the integrated graphics on the system board may be used. The specific graphics card installed and software configuration will determine the behavior.

The system board graphics can be disabled by changing settings in Computer Setup.

Serial number location

Each computer has a unique serial number and a product ID number that are located on the exterior of the computer. Keep these numbers available for use when contacting customer service for assistance.

2 Illustrated parts catalog

Microtower (MT) chassis spare parts

 **NOTE:** HP continually improves and changes product parts. For complete and current information on supported parts for your computer, go to <http://partsurfer.hp.com>, select your country or region, and then follow the on-screen instructions.

Computer major components

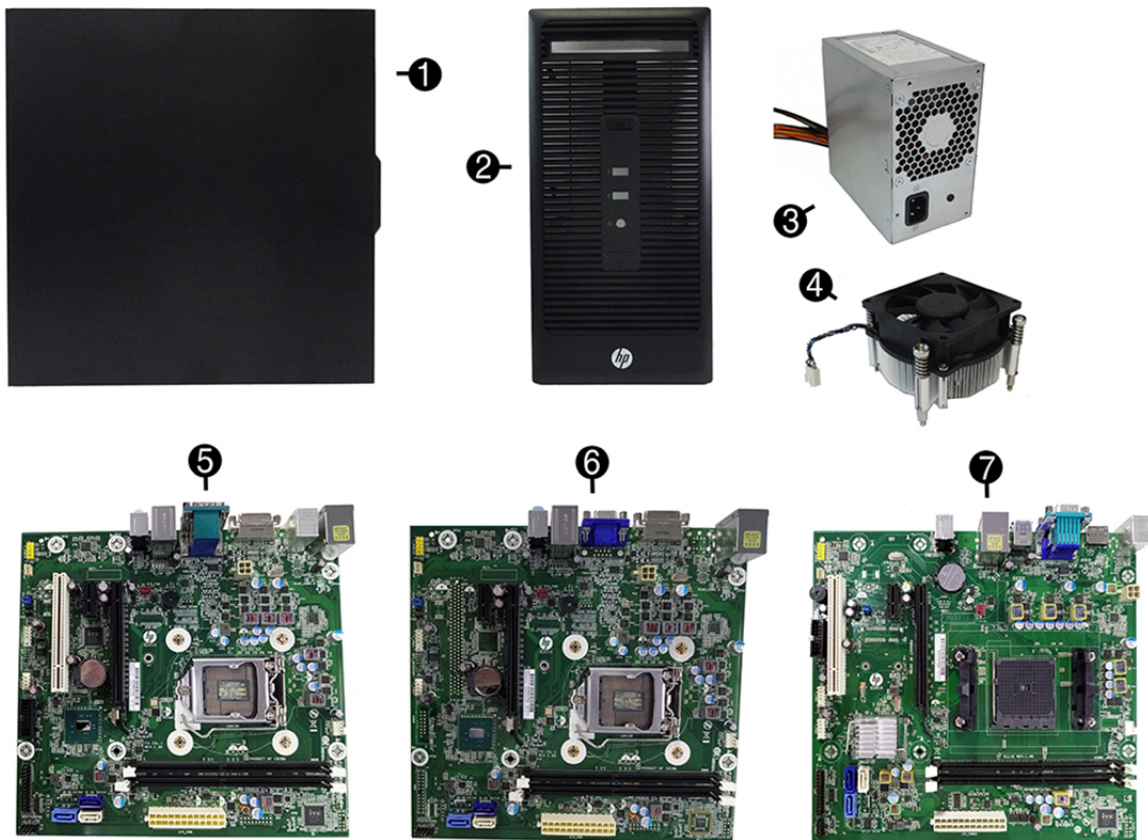

Item	Description
(1)	Access panel
(2)	Front bezel
(3)	Power supply
	300W, APFC (For use only in HP 280 G2 Microtower models in the People's Republic of China)
	300W, Energy Star (For use only in HP 280 G2 Microtower models in the People's Republic of China)
	180W, Energy Star
	180W, Energy Star for use in the APJ region

Item	Description
	180W, APFC
	180W, standard (available only for NA, LA and APJ regions, except the People's Republic of China and India)
(4)	Fan sink (includes replacement thermal material)
	System board (includes replacement thermal material)
(5)	HP 280 Pro G2 Microtower models
(6)	HP 280 G2 Microtower models
(7)	HP 285 G2 Microtower models
*	Memory modules for HP 280 G2 models (PC4-17000, 2133-MHz)
	16-GB
	8-GB
	4-GB
*	Memory modules for HP 285 G2 models (PC3-12800, 1600-MHz)
	8-GB
	4-GB
	2-GB
*	Processors for HP 280 G2 models (include replacement thermal material)
	Intel Core i7-6700, 3.4 GHz
	Intel Core i5-6600, 3.3 GHz
	Intel Core i5-6500, 3.2 GHz
	Intel Core i3-6320, 3.9 GHz
	Intel Core i3-6300, 3.8 GHz
	Intel Core i3-6100, 3.7 GHz
	Intel Pentium G4520, 3.6 GHz
	Intel Pentium G4500, 3.5 GHz
	Intel Pentium G4400, 3.3 GHz
	Intel Celeron G3920, 2.9 GHz
	Intel Celeron G3900, 2.8 GHz
*	Processors for HP 285 G2 models (include replacement thermal material)
	AMD A10-8750B, 3.6 GHz
	AMD A10-7800B, 3.57 GHz
	AMD A8-8650B, 3.2 GHz
	AMD A8-7600B, 3.1 GHz
	AMD A6-8550B, 3.7 GHz
	AMD A6-6420B, 4.0 GHz

Item	Description
	AMD A6-6400B, 3.9 GHz
	AMD A6-5400B, 3.6 GHz
	AMD A4-7300B, 3.8 GHz
	AMD A4-6300B, 3.7 GHz
	AMD A4-5300B, 3.4 GHz

* not illustrated

Misc parts

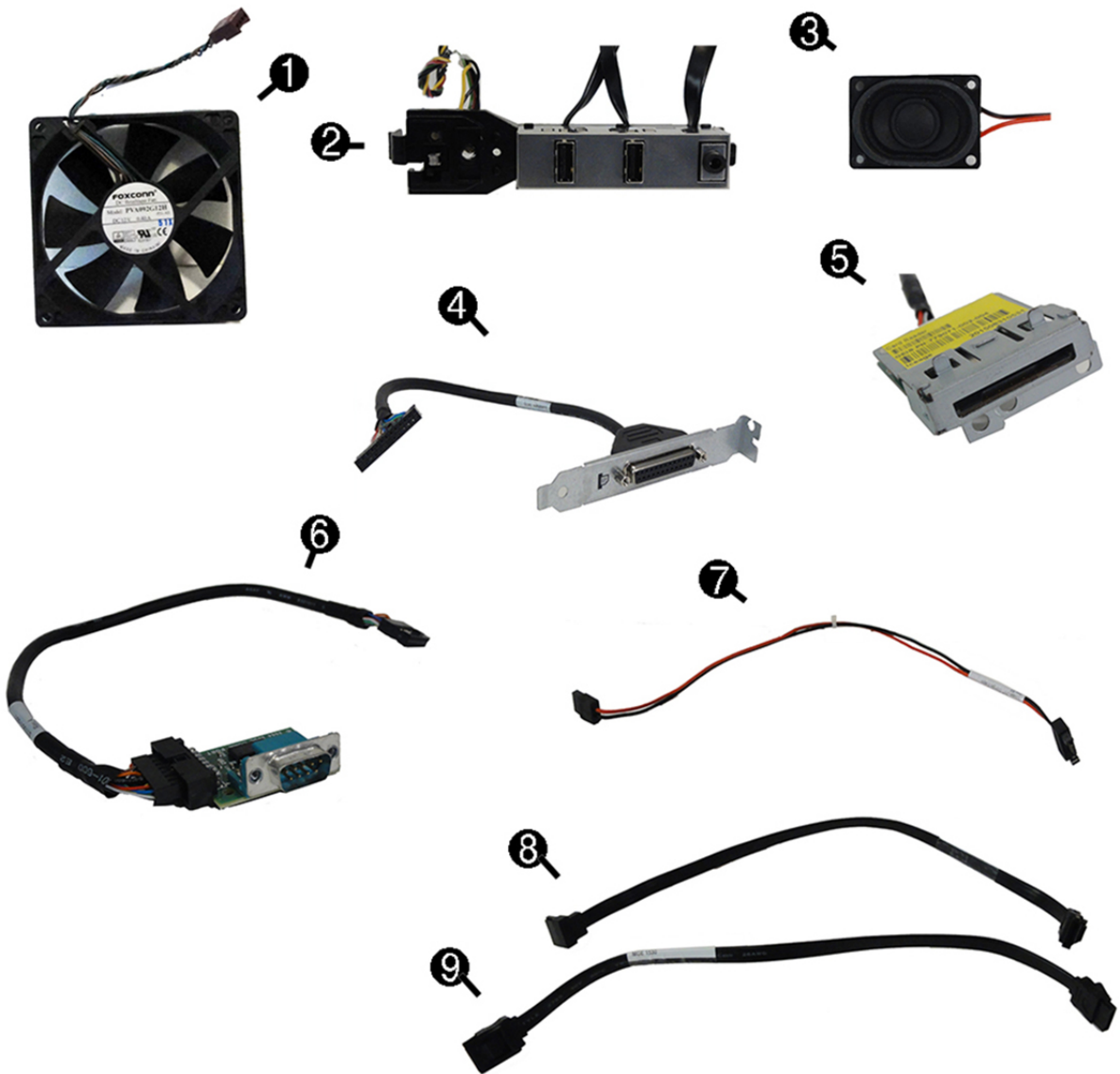

Item	Description
(1)	Fan
(2)	Front I/O assembly
(3)	Speaker
(4)	Printer port , PCI card
(5)	Secure Digital (SD) card reader
(6)	Serial port with cable
(7)	Power adapter for optical drive
(8)	SATA data cable , 280 mm, 1 straight end, 1 angled end
(9)	SATA data cable , 254 mm, 2 straight ends
*	Slim optical drive bezel blank
*	Hard drive conversion bracket, 2.5-inch to 3.5-inch (HP 280 G2 models only)
*	HP Business PC Security Lock
*	Keyed cable lock
*	Grommet, hard drive isolation, blue
*	Intel PRO/1000 Single Port GbE (network adapter)(HP 280 G2 models only)
*	HP webcam (720p)
*	Wireless antenna for use with WLAN modules
*	Mouse
	PS2, optical
	USB, optical
	Antimicrobial (for use only in the People's Republic of China)
	USB, unbranded
	HP USB Hardened
*	Keyboards
	PS/2
	PS/2 slim
	USB, antimicrobial
	HP USB slim
	USB
	Unbranded

* not illustrated

Misc boards

Description
AMD R5 320, 1 GB GDDR3, PCIe x16
nVIDIA GT730, 2 GB DDR3, PCIe x8
nVIDIA GT720, 2 GB DDR3, PCIe x8
Intel PRO/1000 Single Port GbE (network adapter)(HP 280 G2 models only)
Printer port
Serial port
WLAN module, 802.11 a/b/g/n, 2x2, with Bluetooth 4.0
WLAN module caddy card + Bluetooth

Drives

Description
Hard drives/Solid-state drives
2-TB, 7200-rpm
1-TB, 7200-rpm
500-GB, 7200-rpm
256 GB Solid-state Drive (SSD), 2.5 inch (HP 280 G2 models only)
128 GB Solid-state Drive (SSD), 2.5 inch (HP 280 G2 models only)
Grommet , hard drive isolation, blue
Optical drives
DVD±RW drive
DVD-ROM drive

3 Routine care, SATA drive guidelines, and disassembly preparation

This chapter provides general service information for the computer. Adherence to the procedures and precautions described in this chapter is essential for proper service.

CAUTION: When the computer is plugged into an AC power source, voltage is always applied to the system board. You must disconnect the power cord from the power source before opening the computer to prevent system board or component damage.

Electrostatic discharge information

A sudden discharge of static electricity from your finger or other conductor can destroy static-sensitive devices or microcircuitry. Often the spark is neither felt nor heard, but damage occurs. An electronic device exposed to electrostatic discharge (ESD) may not appear to be affected at all and can work perfectly throughout a normal cycle. The device may function normally for a while, but it has been degraded in the internal layers, reducing its life expectancy.

Networks built into many integrated circuits provide some protection, but in many cases, the discharge contains enough power to alter device parameters or melt silicon junctions.

Generating static

The following table shows that:

- Different activities generate different amounts of static electricity.
- Static electricity increases as humidity decreases.

Event	Relative Humidity		
	55%	40%	10%
Walking across carpet	7,500 V	15,000 V	35,000 V
Walking across vinyl floor	3,000 V	5,000 V	12,000 V
Motions of bench worker	400 V	800 V	6,000 V
Removing DIPs from plastic tube	400 V	700 V	2,000 V
Removing DIPs from vinyl tray	2,000 V	4,000 V	11,500 V
Removing DIPs from Styrofoam	3,500 V	5,000 V	14,500 V
Removing bubble pack from PCB	7,000 V	20,000 V	26,500 V
Packing PCBs in foam-lined box	5,000 V	11,000 V	21,000 V

These are then multi-packaged inside plastic tubes, trays, or Styrofoam.

NOTE: 700 volts can degrade a product.

Preventing electrostatic damage to equipment

Many electronic components are sensitive to ESD. Circuitry design and structure determine the degree of sensitivity. The following packaging and grounding precautions are necessary to prevent damage to electric components and accessories.

- To avoid hand contact, transport products in static-safe containers such as tubes, bags, or boxes.
- Protect all electrostatic parts and assemblies with conductive or approved containers or packaging.
- Keep electrostatic sensitive parts in their containers until they arrive at static-free stations.
- Place items on a grounded surface before removing them from their container.
- Always be properly grounded when touching a sensitive component or assembly.
- Avoid contact with pins, leads, or circuitry.
- Place reusable electrostatic-sensitive parts from assemblies in protective packaging or conductive foam.

Personal grounding methods and equipment

Use the following equipment to prevent static electricity damage to equipment:

- **Wrist straps** are flexible straps with a maximum of one-megohm \pm 10% resistance in the ground cords. To provide proper ground, a strap must be worn snug against bare skin. The ground cord must be connected and fit snugly into the banana plug connector on the grounding mat or workstation.
- **Heel straps/Toe straps/Boot straps** can be used at standing workstations and are compatible with most types of shoes or boots. On conductive floors or dissipative floor mats, use them on both feet with a maximum of one-megohm \pm 10% resistance between the operator and ground.

Static Shielding Protection Levels	
Method	Voltage
Antistatic plastic	1,500
Carbon-loaded plastic	7,500
Metallized laminate	15,000

Grounding the work area

To prevent static damage at the work area, use the following precautions:

- Cover the work surface with approved static-dissipative material. Provide a wrist strap connected to the work surface and properly grounded tools and equipment.
- Use static-dissipative mats, foot straps, or air ionizers to give added protection.
- Handle electrostatic sensitive components, parts, and assemblies by the case or PCB laminate. Handle them only at static-free work areas.
- Turn off power and input signals before inserting and removing connectors or test equipment.
- Use fixtures made of static-safe materials when fixtures must directly contact dissipative surfaces.
- Keep work area free of nonconductive materials such as ordinary plastic assembly aids and Styrofoam.
- Use field service tools, such as cutters, screwdrivers, and vacuums, that are conductive.

Recommended materials and equipment

Materials and equipment that are recommended for use in preventing static electricity include:

- Antistatic tape
- Antistatic smocks, aprons, or sleeve protectors
- Conductive bins and other assembly or soldering aids
- Conductive foam
- Conductive tabletop workstations with ground cord of one-megohm +/- 10% resistance
- Static-dissipative table or floor mats with hard tie to ground
- Field service kits
- Static awareness labels
- Wrist straps and footwear straps providing one-megohm +/- 10% resistance
- Material handling packages
- Conductive plastic bags
- Conductive plastic tubes
- Conductive tote boxes
- Opaque shielding bags
- Transparent metallized shielding bags
- Transparent shielding tubes

Operating guidelines

To prevent overheating and to help prolong the life of the computer:

- Keep the computer away from excessive moisture, direct sunlight, and extremes of heat and cold.
- Operate the computer on a sturdy, level surface. Leave a 10.2-cm (4-inch) clearance on all vented sides of the computer and above the monitor to permit the required airflow.
- Never restrict the airflow into the computer by blocking any vents or air intakes. Do not place the keyboard, with the keyboard feet down, directly against the front of the desktop unit as this also restricts airflow.
- Occasionally clean the air vents on all vented sides of the computer. Lint, dust, and other foreign matter can block the vents and limit the airflow. Be sure to unplug the computer before cleaning the air vents.
- Never operate the computer with the cover or side panel removed.
- Do not stack computers on top of each other or place computers so near each other that they are subject to each other's re-circulated or preheated air.
- If the computer is to be operated within a separate enclosure, intake and exhaust ventilation must be provided on the enclosure, and the same operating guidelines listed above will still apply.
- Keep liquids away from the computer and keyboard.

- Never cover the ventilation slots on the monitor with any type of material.
- Install or enable power management functions of the operating system or other software, including sleep states.

Routine care

General cleaning safety precautions

1. Never use solvents or flammable solutions to clean the computer.
2. Never immerse any parts in water or cleaning solutions; apply any liquids to a clean cloth and then use the cloth on the component.
3. Always unplug the computer when cleaning with liquids or damp cloths.
4. Always unplug the computer before cleaning the keyboard, mouse, or air vents.
5. Disconnect the keyboard before cleaning it.
6. Wear safety glasses equipped with side shields when cleaning the keyboard.

Cleaning the Computer Case

Follow all safety precautions in [General cleaning safety precautions on page 12](#) before cleaning the computer.

To clean the computer case, follow the procedures described below:

- To remove light stains or dirt, use plain water with a clean, lint-free cloth or swab.
- For stronger stains, use a mild dishwashing liquid diluted with water. Rinse well by wiping it with a cloth or swab dampened with clear water.
- For stubborn stains, use isopropyl (rubbing) alcohol. No rinsing is needed as the alcohol will evaporate quickly and not leave a residue.
- After cleaning, always wipe the unit with a clean, lint-free cloth.
- Occasionally clean the air vents on the computer. Lint and other foreign matter can block the vents and limit the airflow.

Cleaning the keyboard

Follow all safety precautions in [General cleaning safety precautions on page 12](#) before cleaning the keyboard.

To clean the tops of the keys or the keyboard body, follow the procedures described in [Cleaning the Computer Case on page 12](#).

When cleaning debris from under the keys, review all rules in [General cleaning safety precautions on page 12](#) before following these procedures:

 **CAUTION:** Use safety glasses equipped with side shields before attempting to clean debris from under the keys.

- Visible debris underneath or between the keys may be removed by vacuuming or shaking.
- Canned, pressurized air may be used to clean debris from under the keys. Caution should be used as too much air pressure can dislodge lubricants applied under the wide keys.

- If you remove a key, use a specially designed key puller to prevent damage to the keys. This tool is available through many electronic supply outlets.

⚠ CAUTION: Never remove a wide leveled key (like the space bar) from the keyboard. If these keys are improperly removed or installed, the keyboard may not function properly.

- Cleaning under a key may be done with a swab moistened with isopropyl alcohol and squeezed out. Be careful not to wipe away lubricants necessary for proper key functions. Use tweezers to remove any fibers or dirt in confined areas. Allow the parts to air dry before reassembly.

Cleaning the monitor

- Wipe the monitor screen with a clean cloth moistened with water or with a towelette designed for cleaning monitors. Do not use sprays or aerosols directly on the screen; the liquid may seep into the housing and damage a component. Never use solvents or flammable liquids on the monitor.
- To clean the monitor body follow the procedures in [Cleaning the Computer Case on page 12](#).

Cleaning the mouse

Before cleaning the mouse, ensure that the power to the computer is turned off.

- Clean the mouse ball by first removing the retaining plate and the ball from the housing. Pull out any debris from the ball socket and wipe the ball with a clean, dry cloth before reassembly.
- To clean the mouse body, follow the procedures in [Cleaning the Computer Case on page 12](#).

Service considerations

Listed below are some of the considerations that you should keep in mind during the disassembly and assembly of the computer.

Power supply fan

The power supply fan is a variable-speed fan based on the temperature in the power supply.

⚠ CAUTION: The cooling fan is always on when the computer is in the “On” mode. The cooling fan is off when the computer is in “Standby,” “Suspend,” or “Off” modes.

You must disconnect the power cord from the power source before opening the computer to prevent system board or component damage.

Tools and software Requirements

To service the computer, you need the following:

- Torx T-15 screwdriver
- Torx T-15 screwdriver with small diameter shank (for certain front bezel removal)
- Flat-bladed screwdriver (may sometimes be used in place of the Torx screwdriver)
- Phillips #2 screwdriver
- Diagnostics software
- Tamper-resistant T-15 wrench

Screws

The screws used in the computer are not interchangeable. They may have standard or metric threads and may be of different lengths. If an incorrect screw is used during the reassembly process, it can damage the unit. HP strongly recommends that all screws removed during disassembly be kept with the part that was removed, then returned to their proper locations.

⚠ CAUTION: Metric screws have a black finish. U.S. screws have a silver finish and are used on hard drives only.

CAUTION: As each subassembly is removed from the computer, it should be placed away from the work area to prevent damage.

Cables and connectors

Most cables used throughout the unit are flat, flexible cables. These cables must be handled with care to avoid damage. Apply only the tension required to seat or unseat the cables during insertion or removal from the connector. Handle cables by the connector whenever possible. In all cases, avoid bending or twisting the cables, and ensure that the cables are routed in such a way that they cannot be caught or snagged by parts being removed or replaced.

⚠ CAUTION: When servicing this computer, ensure that cables are placed in their proper location during the reassembly process. Improper cable placement can damage the computer.

Hard Drives

Handle hard drives as delicate, precision components, avoiding all physical shock and vibration. This applies to failed drives as well as replacement spares.

- If a drive must be mailed, place the drive in a bubble-pack mailer or other suitable protective packaging and label the package “Fragile: Handle With Care.”
- Do not remove hard drives from the shipping package for storage. Keep hard drives in their protective packaging until they are actually mounted in the computer.
- Avoid dropping drives from any height onto any surface.
- If you are inserting or removing a hard drive, turn off the computer. Do not remove a hard drive while the computer is on or in standby mode.
- Before handling a drive, ensure that you are discharged of static electricity. While handling a drive, avoid touching the connector.
- Do not use excessive force when inserting a drive.
- Avoid exposing a hard drive to liquids, temperature extremes, or products that have magnetic fields such as monitors or speakers.

Lithium coin cell battery

The battery that comes with the computer provides power to the real-time clock and has a minimum lifetime of about three years.

See the appropriate removal and replacement chapter for the chassis you are working on in this guide for instructions on the replacement procedures.

⚠ WARNING! This computer contains a lithium battery. There is a risk of fire and chemical burn if the battery is handled improperly. Do not disassemble, crush, puncture, short external contacts, dispose in water or fire, or expose it to temperatures higher than 140°F (60°C). Do not attempt to recharge the battery.

 **NOTE:** Batteries, battery packs, and accumulators should not be disposed of together with the general household waste. In order to forward them to recycling or proper disposal, please use the public collection system or return them to HP, their authorized partners, or their agents.

SATA hard drives

Serial ATA Hard Drive Characteristics	
Number of pins/conductors in data cable	7/7
Number of pins in power cable	15
Maximum data cable length	39.37 in (100 cm)
Data interface voltage differential	400-700 mV
Drive voltages	3.3 V, 5 V, 12 V
Jumpers for configuring drive	N/A
Data transfer rate	6.0 Gb/s

SATA hard drive cables

SATA data cable

Always use an HP approved SATA 6.0 Gb/s cable as it is fully backwards compatible with the SATA 1.5 Gb/s drives.

Current HP desktop products ship with SATA 6.0 Gb/s hard drives.

SATA data cables are susceptible to damage if overflexed. Never crease a SATA data cable and never bend it tighter than a 30 mm (1.18 in) radius.

The SATA data cable is a thin, 7-pin cable designed to transmit data for only a single drive.

SMART ATA drives

The Self Monitoring Analysis and Recording Technology (SMART) ATA drives for the HP Personal Computers have built-in drive failure prediction that warns the user or network administrator of an impending failure or crash of the hard drive. The SMART drive tracks fault prediction and failure indication parameters such as reallocated sector count, spin retry count, and calibration retry count. If the drive determines that a failure is imminent, it generates a fault alert.

Cable management

Always follow good cable management practices when working inside the computer.

- Keep cables away from major heat sources like the heat sink.
- Do not jam cables on top of expansion cards or memory modules. Printed circuit cards like these are not designed to take excessive pressure on them.
- Keep cables clear of sliding or moveable parts to prevent them from being cut or crimped when the parts are moved.
- When folding a flat ribbon cable, never fold to a sharp crease. Sharp creases may damage the wires.
- Some flat ribbon cables come prefolded. Never change the folds on these cables.
- Do not bend any cable sharply. A sharp bend can break the internal wires.
- Never bend a SATA data cable tighter than a 30 mm (1.18 in) radius.
- Never crease a SATA data cable.
- Do not rely on components like the drive cage, power supply, or computer cover to push cables down into the chassis. Always position the cables to lay properly by themselves.

4 Removal and replacement procedures – Microtower (MT) chassis

Adherence to the procedures and precautions described in this chapter is essential for proper service. After completing all necessary removal and replacement procedures, run the Diagnostics utility to verify that all components operate properly.

 **NOTE:** Not all features listed in this guide are available on all computers.

Preparation for disassembly

See [Routine care, SATA drive guidelines, and disassembly preparation on page 9](#) for initial safety procedures.

1. Remove/disengage any security devices that prohibit opening the computer.
2. Close any open software applications.
3. Exit the operating system.
4. Remove any compact disc or media card from the computer.
5. Turn off the computer and any peripheral devices that are connected to it.

 **CAUTION:** Turn off the computer before disconnecting any cables.

Regardless of the power-on state, voltage is always present on the system board as long as the system is plugged into an active AC outlet. In some systems the cooling fan is on even when the computer is in the “Standby,” or “Suspend” modes. The power cord should always be disconnected before servicing a unit.

-
6. Disconnect the power cord from the electrical outlet and then from the computer.
 7. As applicable, lay the computer down on its side to achieve a safe working position.

 **NOTE:** During disassembly, label each cable as you remove it, noting its position and routing. Keep all screws with the units removed.

 **CAUTION:** The screws used in the computer are of different thread sizes and lengths; using the wrong screw in an application may damage the unit.

Access panel

To access internal components, you must remove the access panel:

1. Prepare the computer for disassembly ([Preparation for disassembly on page 17](#))
2. Remove the two Torx screws (1), and then slide the panel back (2) and lift it off the computer (3).

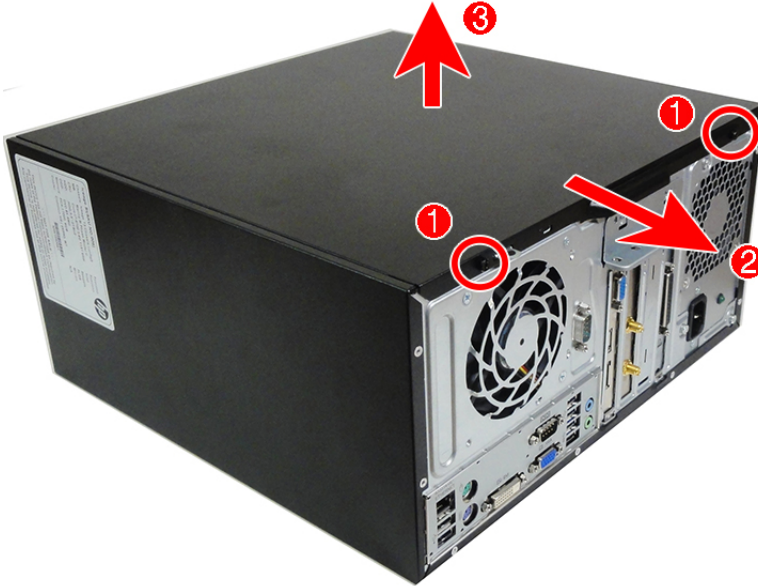

To replace the access panel, reverse the disassembly procedures.

Front bezel

1. Prepare the computer for disassembly ([Preparation for disassembly on page 17](#))
2. Remove the access panel ([Access panel on page 18](#))
3. Lift up the three tabs on the side of the bezel (**1**), and then rotate the bezel off the chassis (**2**).

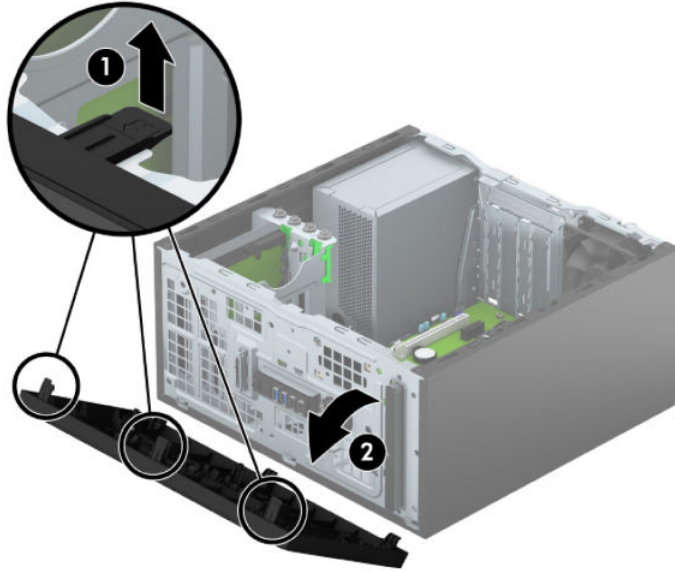

To replace the front bezel, reverse the disassembly procedures.

Front bezel security

The front bezel can be secured in place by installing a screw through the front of the chassis into the front bezel.

1. Prepare the computer for disassembly ([Preparation for disassembly on page 17](#))
2. Remove the access panel ([Access panel on page 18](#))
3. Install a 6-32 screw through the front of the chassis and into the screw hole located below the center bezel release tab.

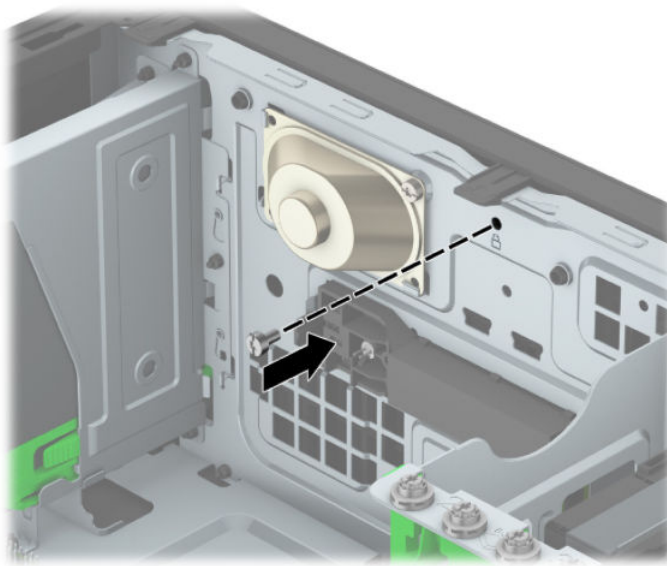

4. Replace the computer access panel.
5. Reconnect the power cord and any external devices, and then turn on the computer.
6. Lock any security devices that were disengaged when the access panel was removed.

Slim optical drive bezel blank

On some models, there is a bezel blank covering the slim optical drive bay. Remove the bezel blank before installing an optical drive. To remove the bezel blank:

1. Remove the access panel ([Access panel on page 18](#))
2. Remove the front bezel ([Front bezel on page 19](#))
3. To remove the bezel blank, press upward on the bottom tab and press downward on the top tab on the side of the blank **(1)**, and then rotate the blank off the front of the bezel **(2)**.

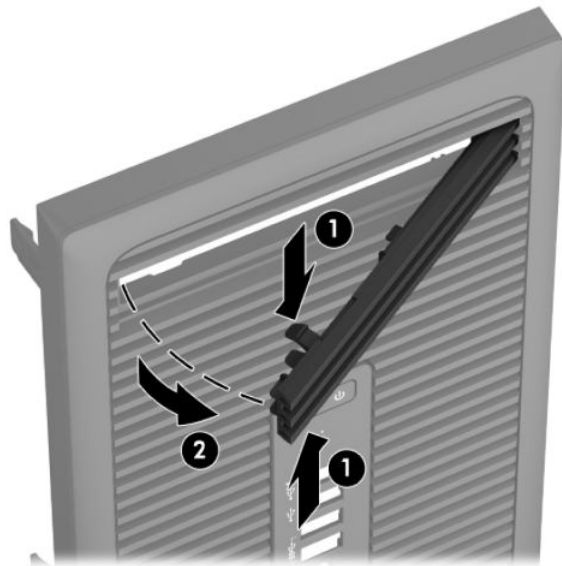

Memory

Description
Memory modules for HP 280 G2 models (PC4-17000, 2133-MHz)
16-GB
8-GB
4-GB
Memory modules for HP 285 G2 models (PC3-12800, 1600-MHz)
8-GB
4-GB
2-GB

DIMMs

The memory sockets on the system board can be populated with up to two industry-standard DIMMs. These memory sockets are populated with at least one preinstalled DIMM. To achieve the maximum memory support, you can populate the system board with up to 16 GB of memory.

DIMM specifications

For proper system operation, the DIMMs must meet the following qualifications:

	HP 280 G2	HP 285 G2
DIMM	1.5 volt DDR3-SDRAM DIMMs	1.2 volt DDR4-SDRAM DIMMs
Compliance	unbuffered non-ECC PC3-12800 DDR3-1600 MHz-compliant	unbuffered non-ECC PC4-17000 DDR4-2133 MHz-compliant
Pins	industry-standard 240-pin containing the mandatory Joint Electronic Device Engineering Council (JEDEC) specification	industry-standard 240-pin containing the mandatory Joint Electronic Device Engineering Council (JEDEC) specification
Support	support CAS latency 11 DDR3 1600 MHz (11-11-11 timing)	support CAS latency 15 DDR4 2133 MHz (15-15-15 timing)
Slots	2	2
Maximum Memory	16 GB	16 GB

HP offers upgrade memory for this computer and advises that the consumer purchase it to avoid compatibility issues with unsupported third-party memory.

Populating DIMM sockets

There are two DIMM sockets on the system board, with two sockets per channel. The sockets are labeled XMM1 and XMM2. Socket XMM1 operates in memory channel A. Socket XMM2 operates in memory channel B.

The system will automatically operate in single channel mode, dual channel mode, or flex mode, depending on how the DIMMs are installed.



NOTE: Single channel and unbalanced dual channel memory configurations will result in inferior graphics performance.

- The system will operate in single channel mode if the DIMM sockets are populated in one channel only.
- The system will operate in a higher-performing dual channel mode if the total memory capacity of the DIMMs in Channel A is equal to the total memory capacity of the DIMMs in Channel B. The technology and device width can vary between the channels. For example, if Channel A is populated with two 1-GB DIMMs and Channel B is populated with one 2-GB DIMM, the system will operate in dual channel mode.
- The system will operate in flex mode if the total memory capacity of the DIMMs in Channel A is not equal to the total memory capacity of the DIMMs in Channel B. In flex mode, the channel populated with the least amount of memory describes the total amount of memory assigned to dual channel and the remainder is assigned to single channel. For optimal speed, the channels should be balanced so that the largest amount of memory is spread between the two channels. If one channel will have more memory than the other, the larger amount should be assigned to Channel A. For example, if you are populating the sockets with one 2-GB DIMM, and three 1-GB DIMMs, Channel A should be populated with the 2-GB DIMM and one 1-GB DIMM, and Channel B should be populated with the other two 1-GB DIMMs. With this configuration, 4-GB will run as dual channel and 1-GB will run as single channel.
- In any mode, the maximum operational speed is determined by the slowest DIMM in the system.

Installing DIMMs



CAUTION: You must disconnect the power cord and wait approximately 30 seconds for the power to drain before adding or removing memory modules. Regardless of the power-on state, voltage is always supplied to the memory modules as long as the computer is plugged into an active AC outlet. Adding or removing memory modules while voltage is present may cause irreparable damage to the memory modules or system board.

The memory module sockets have gold-plated metal contacts. When upgrading the memory, it is important to use memory modules with gold-plated metal contacts to prevent corrosion and/or oxidation resulting from having incompatible metals in contact with each other.

Static electricity can damage the electronic components of the computer or optional cards. Before beginning these procedures, ensure that you are discharged of static electricity by briefly touching a grounded metal object.

When handling a memory module, be careful not to touch any of the contacts. Doing so may damage the module.

1. Prepare the computer for disassembly ([Preparation for disassembly on page 17](#))
2. Remove the access panel ([Access panel on page 18](#))
3. Open both latches of the memory module socket **(1)**, and insert the memory module into the socket **(2)**.



NOTE: A memory module can be installed in only one way. Match the notch on the module with the tab on the memory socket.

Populate the XMM1 socket before the XMM2 socket.

4. Push the module down into the socket, ensuring that the module is fully inserted and properly seated. Make sure the latches are in the closed position **(3)**.

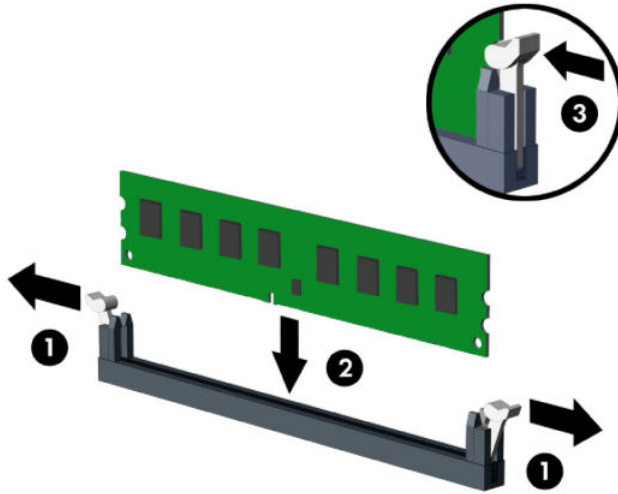

5. Repeat steps 3 and 4 to install any additional modules.
6. Replace the computer access panel.
7. Reconnect the power cord and turn on the computer.
8. Lock any security devices that were disengaged when the access panel was removed.

The computer should automatically recognize the additional memory the next time you turn on the computer.

Expansion cards

Description
AMD R5 320, 1 GB GDDR3, PCIe x16
nVIDIA GT730, 2 GB DDR3, PCIe x8
nVIDIA GT720, 2 GB DDR3, PCIe x8
Intel PRO/1000 Single Port GbE (network adapter)(HP 280 G2 models only)
Printer port
Serial port
WLAN module, 802.11 a/b/g/n, 2x2, with Bluetooth 4.0
WLAN module caddy card + Bluetooth

HP 280 G2 models have one PCI expansion socket (select models only), one PCI Express x1 expansion socket, and one PCI Express x16 expansion socket.

HP 285 G2 models have one PCI expansion socket, one PCI Express x1 expansion socket, and one PCI Express x16 expansion socket.

 **NOTE:** You can install a PCI Express x1, x8, or x16 expansion card in the PCI Express x16 socket.

To remove, replace, or add an expansion card:

1. Prepare the computer for disassembly ([Preparation for disassembly on page 17](#))
2. Remove the access panel ([Access panel on page 18](#))
3. Release the slot cover retention latch that secures the slot covers by removing the Torx screw **(1)**, sliding the latch up **(2)**, and pulling the latch away from the computer **(3)**.

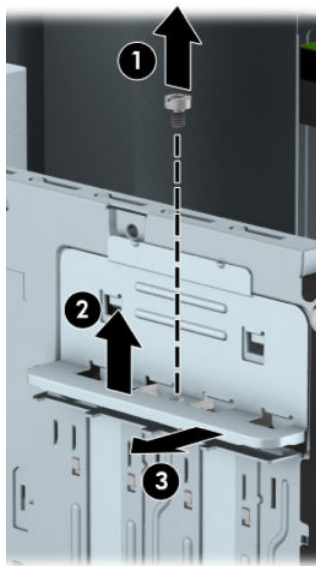

4. Locate the correct vacant expansion socket on the system board and the corresponding expansion slot on the back of the computer chassis.

5. Before installing an expansion card, remove the expansion slot cover or the existing expansion card.

 **NOTE:** Before removing an installed expansion card, disconnect any cables that may be attached to the expansion card.

- a. If you are installing an expansion card in a vacant socket, you must slide one of the expansion slot covers up and out of the chassis or use a flatblade screwdriver to pry out one of the metal shields on the rear panel that covers the expansion slot. Be sure to remove the appropriate shield for the expansion card you are installing.

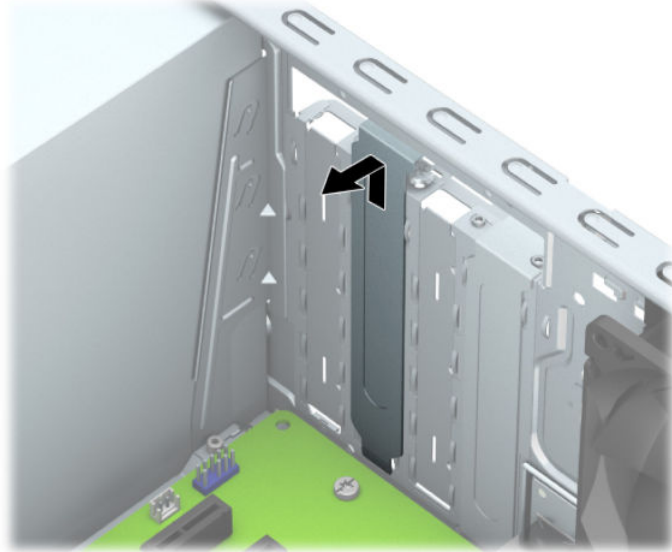

- b. If you are removing a PCI Express x1 card, hold the card at each end and carefully rock it back and forth until the connectors pull free from the socket. Lift the card straight up **(1)** then away from the inside of the chassis **(2)** to remove it. Be sure not to scrape the card against other components.

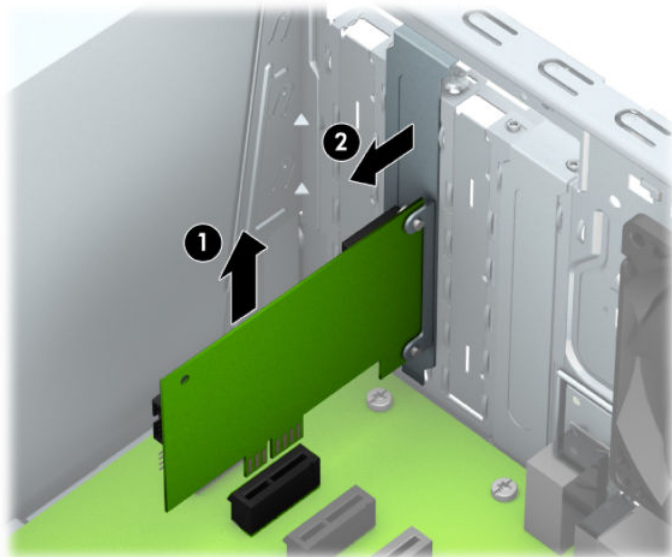

- c. If you are removing a PCI Express x16 card, pull the retention arm on the back of the expansion socket away from the card and carefully rock the card back and forth until the connectors pull free from the socket. Lift the card straight up then away from the inside of the chassis to remove it. Be sure not to scrape the card against other components.

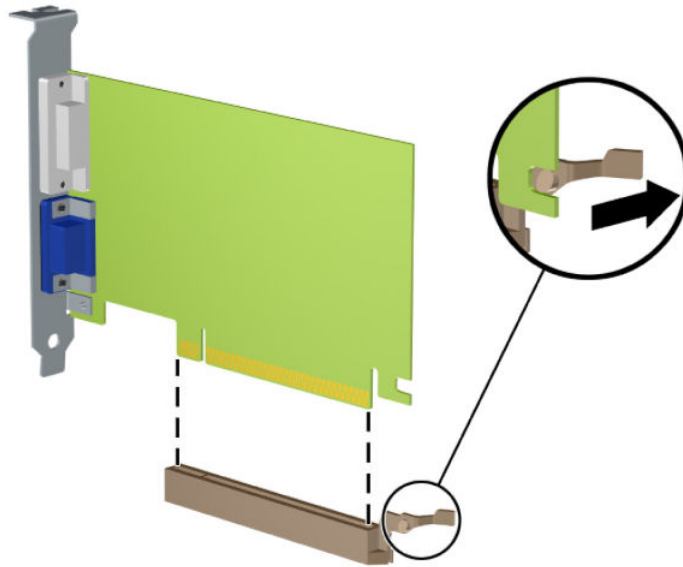

6. Store the removed card in anti-static packaging.
7. If you are not installing a new expansion card, install an expansion slot cover to close the open slot.

CAUTION: After removing an expansion card, you must replace it with a new card or expansion slot cover for proper cooling of internal components during operation.

To replace an expansion card, reverse the removal procedures.

Reconfigure the computer, if necessary.

Drives

Description
Hard drives/Solid-state drives
2-TB, 7200-rpm
1-TB, 7200-rpm
500-GB, 7200-rpm
256 GB Solid-state Drive (SSD), 2.5 inch (HP 280 G2 models only)
128 GB Solid-state Drive (SSD), 2.5 inch (HP 280 G2 models only)
Grommet , hard drive isolation, blue
Optical drives
DVD±RW drive
DVD-ROM drive

When installing drives, follow these guidelines:

- The primary Serial ATA (SATA) hard drive must be connected to the dark blue primary SATA connector on the system board labeled SATA0.
- Connect secondary hard drives and optical drives to one of the remaining SATA connectors on the system board (labeled SATA1 and SATA2).
- HP has provided four extra 6-32 hard drive mounting screws installed on the front of the chassis next to the hard drive bays (1). If you are replacing a hard drive, remove the mounting screws from the old drive and install them in the new drive.

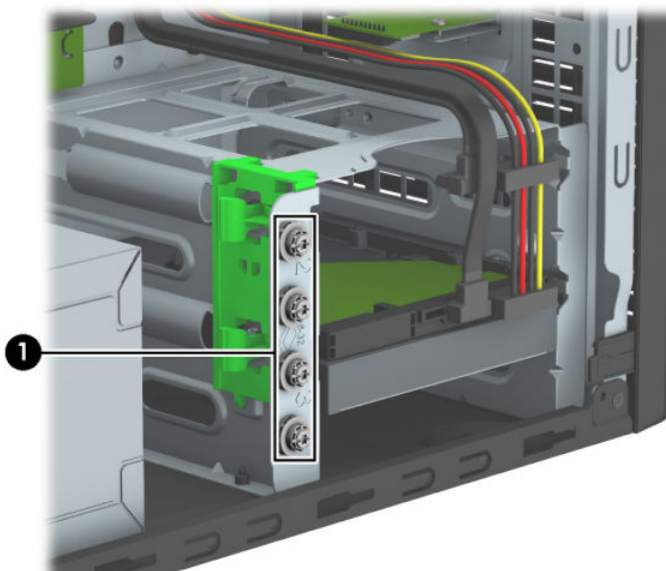

CAUTION: To prevent loss of work and damage to the computer or drive:

If you are inserting or removing a drive, shut down the operating system properly, turn off the computer, and unplug the power cord. Do not remove a drive while the computer is on or in standby mode.

Before handling a drive, ensure that you are discharged of static electricity. While handling a drive, avoid touching the connector. For more information about preventing electrostatic damage, refer to [Electrostatic discharge information on page 9](#).

Handle a drive carefully; do not drop it.

Do not use excessive force when inserting a drive.

Avoid exposing a hard drive to liquids, temperature extremes, or products that have magnetic fields such as monitors or speakers.

If a drive must be mailed, place the drive in a bubble-pack mailer or other protective packaging and label the package “Fragile: Handle With Care.”

Drive positions

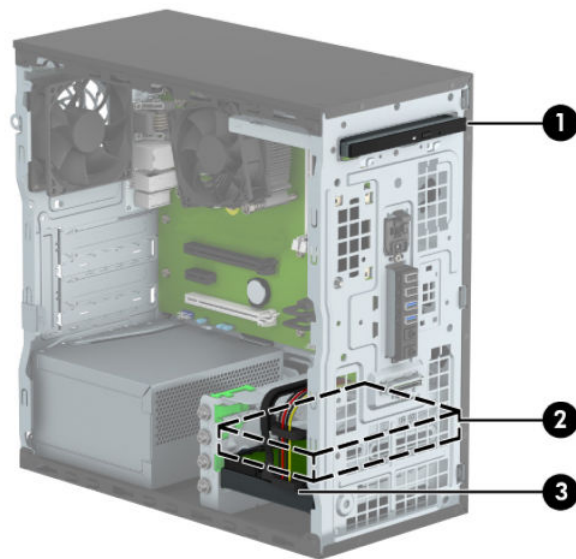

Item	Component
1	9.5-mm slim optical drive bay
2	3.5-inch secondary hard drive bay
3	3.5-inch primary hard drive bay

NOTE: The drive configuration on your computer may be different than the drive configuration shown above.

To verify the type and size of the storage devices installed in the computer, run Computer Setup.

Removing a 9.5 mm slim optical drive

1. Prepare the computer for disassembly ([Preparation for disassembly on page 17](#))
2. Remove the access panel ([Access panel on page 18](#))
3. Remove the front bezel ([Front bezel on page 19](#))
4. Disconnect the power cable **(1)** and data cable **(2)** from the rear of the optical drive.

⚠ CAUTION: When removing the cables, pull the tab or connector instead of the cable itself to avoid damaging the cable.

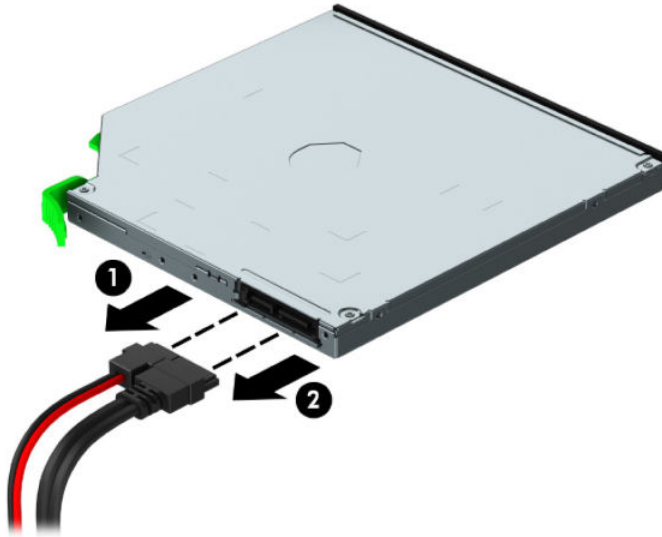

⚠ CAUTION: When removing the cables, pull the tab or connector instead of the cable itself to avoid damaging the cable.

5. Press upward on the green release latch on the underside of the drive **(1)**, and then slide the drive out of the drive bay **(2)**.

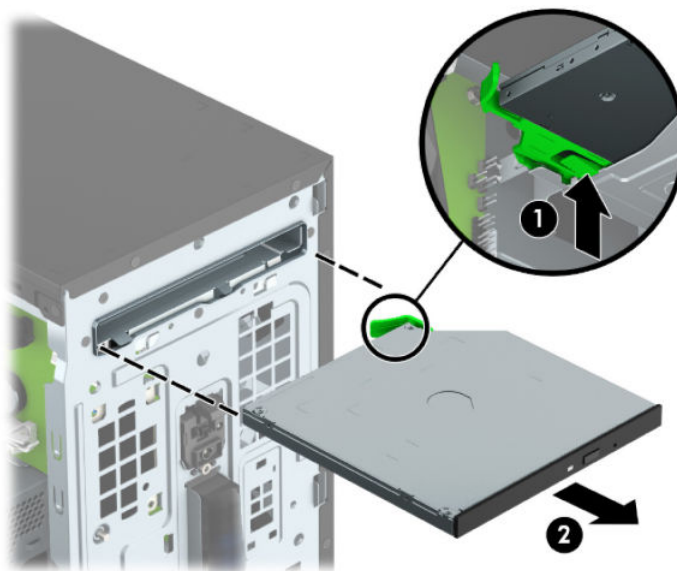

Installing a 9.5 mm slim optical drive

1. Prepare the computer for disassembly ([Preparation for disassembly on page 17](#)).
2. Remove the access panel ([Access panel on page 18](#)).
3. If you are installing a slim optical drive in a bay covered by a bezel blank, remove the front bezel and then remove the bezel blank. See [Front bezel on page 19](#) for more information.
4. Follow the instructions for removing the optical drive if one was installed. Refer to [Removing a 9.5 mm slim optical drive on page 30](#).
5. Align the small pin on the release latch with the small hole on the side of the drive and press the latch firmly onto the drive.

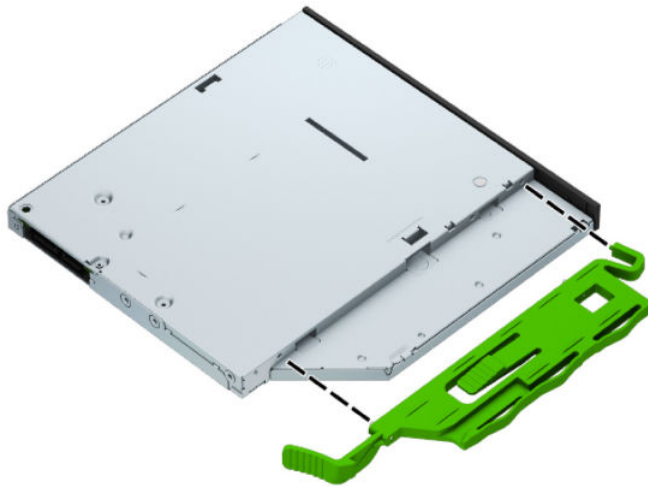

6. Slide the optical drive through the front of the chassis (1) all the way into the bay so that the green latch locks onto the chassis frame (2).

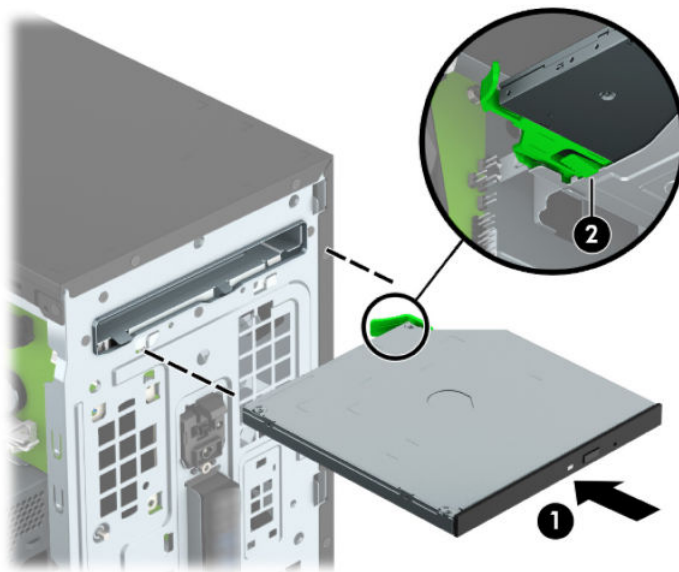

7. Connect the power cable **(1)** and data cable **(2)** to the rear of the optical drive.

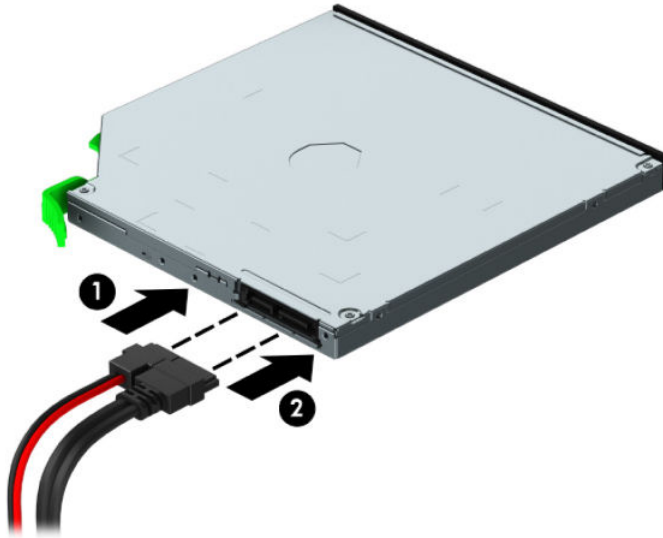

8. If installing a new drive, connect the opposite end of the data cable to one of the SATA connectors (labeled SATA1 or SATA2) on the system board.
9. Replace the front bezel if it was removed.
10. Replace the computer access panel.
11. Reconnect the power cord and any external devices, and then turn on the computer.
12. Lock any security devices that were disengaged when the access panel was removed.

Removing a hard drive

 **NOTE:** Before you remove the old hard drive, be sure to back up the data from the old hard drive so that you can transfer the data to the new hard drive.

1. Prepare the computer for disassembly ([Preparation for disassembly on page 17](#)).
2. Remove the access panel ([Access panel on page 18](#)).
3. Disconnect the power cable **(1)** and data cable **(2)** from the rear of the hard drive.

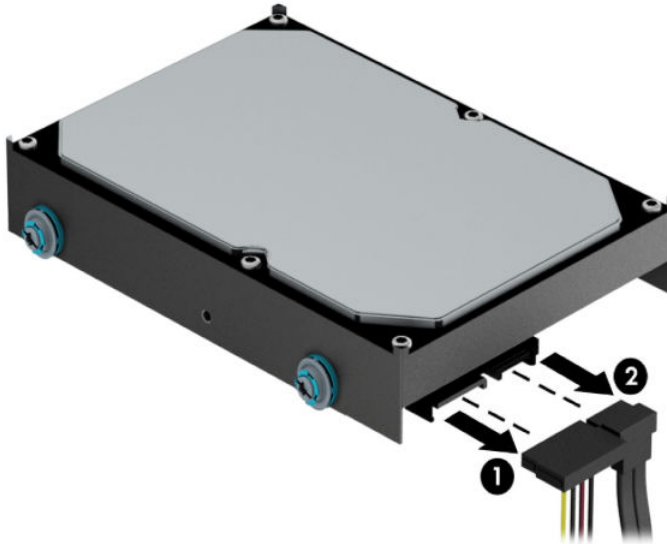

4. Pull the green latch next to the drive outward **(1)** and slide the drive out of the bay **(2)**.

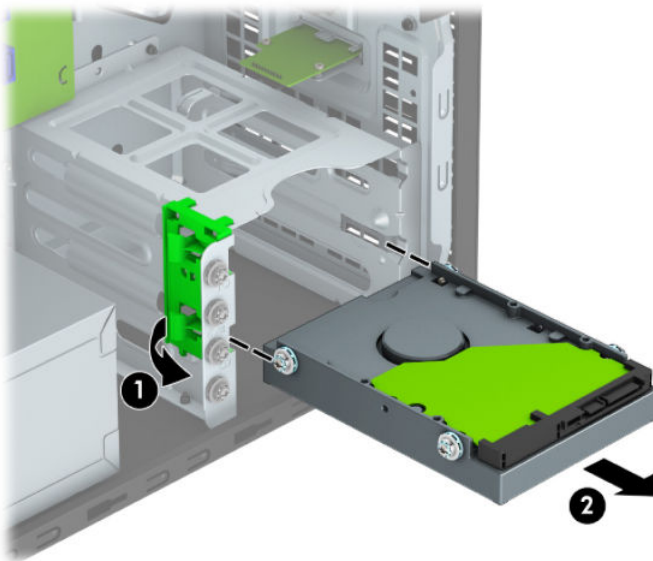

Installing a hard drive

1. Prepare the computer for disassembly ([Preparation for disassembly on page 17](#)).
2. Remove the access panel ([Access panel on page 18](#)).
3. You can install a 3.5-inch hard drive or a 2.5-inch hard drive with a 3.5-inch adapter bracket similar to the example shown below.
 - Slide the 2.5-inch drive into the bay adapter bracket, ensuring the connector on the drive is fully inserted into the connector on the adapter bracket.

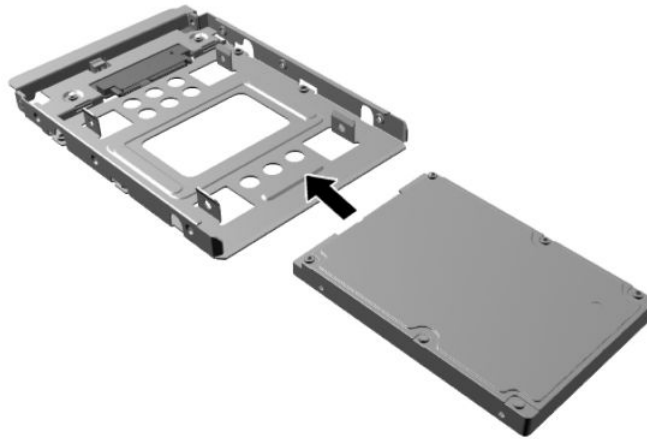

- Secure the drive to the bay adapter bracket by installing four black M3 adapter bracket screws through the sides of the bracket into the drive.

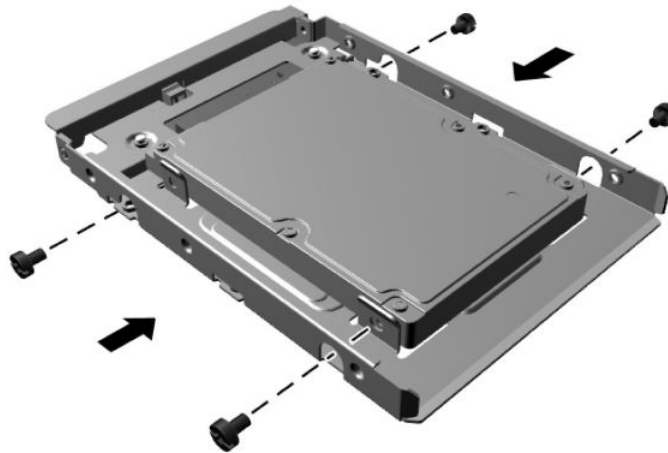

4. Install four mounting screws into the sides of the 3.5-inch drive or the 2.5-inch drive adapter bracket (two on each side).

 **NOTE:** HP has supplied four extra mounting screws installed on the chassis next to the hard drive bays. Refer to [Drives on page 28](#) for an illustration of the location of the extra mounting screws.

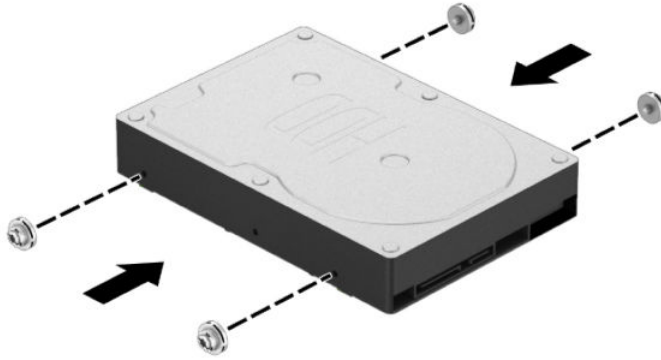

5. Slide the drive into the drive bay, making sure to align the mounting screws with the guide slots, until the drive snaps into place.

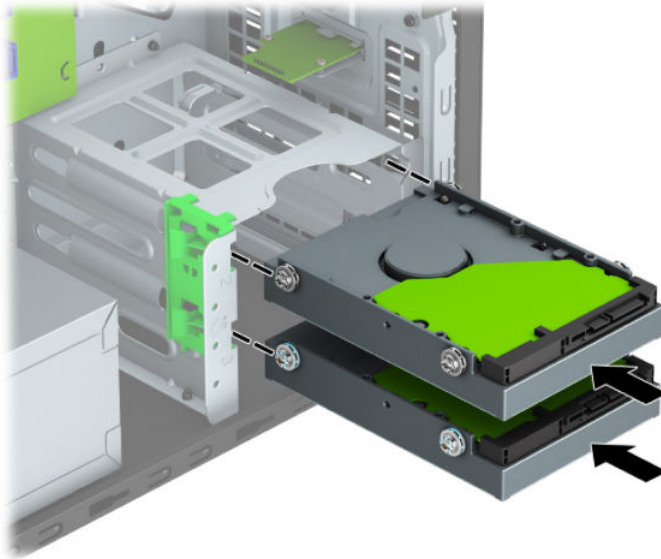

6. Connect the power cable **(1)** and data cable **(2)** to the rear of the hard drive.

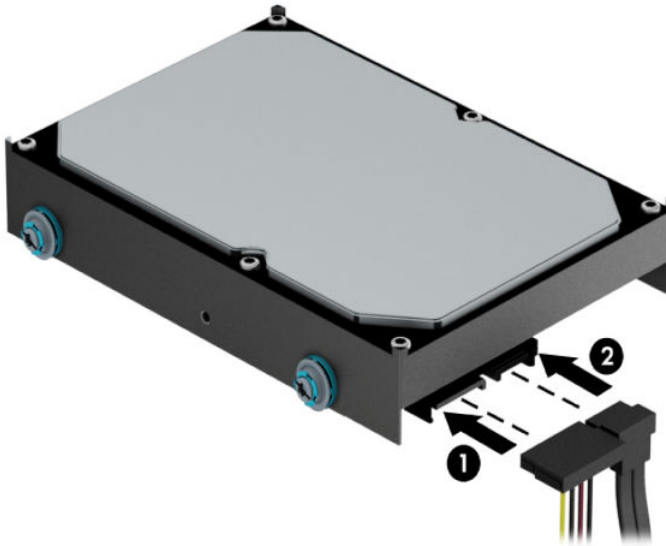

7. If installing a new drive, connect the opposite end of the data cable to the appropriate system board connector.

 **NOTE:** You must connect the primary hard drive data cable to the dark blue connector labeled SATA0 to avoid any hard drive performance problems. If you are adding a second hard drive, connect the data cable to one of the SATA connectors labeled SATA1 or SATA2.

8. Replace the computer access panel.
9. Reconnect the power cord and any external devices, and then turn on the computer.
10. Lock any security devices that were disengaged when the access panel was removed.

Front I/O and power switch assembly

1. Prepare the computer for disassembly ([Preparation for disassembly on page 17](#)).
2. Remove the computer access panel ([Access panel on page 18](#)).
3. Remove the front bezel ([Front bezel on page 19](#)).
4. Remove the cables from the clips on the base pan.

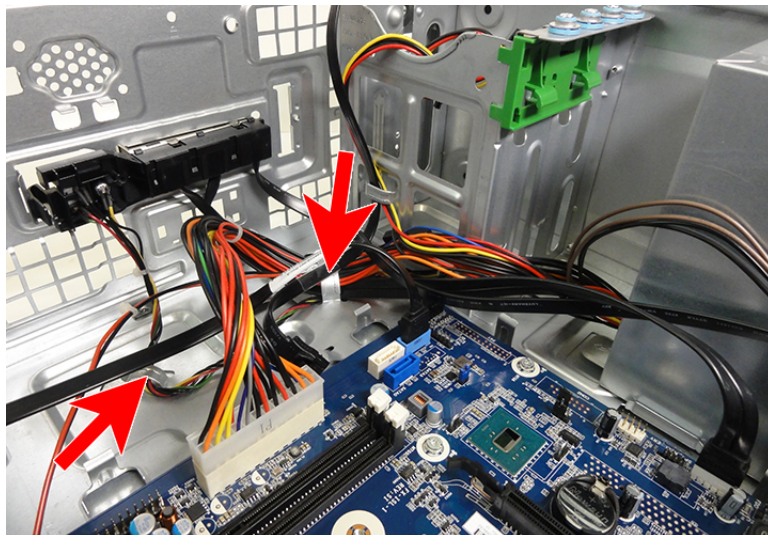

5. Disconnect the three cables from the following system board connectors:

F_PANEL (black)

F_USB1 (white)

F_AUDIO (yellow)

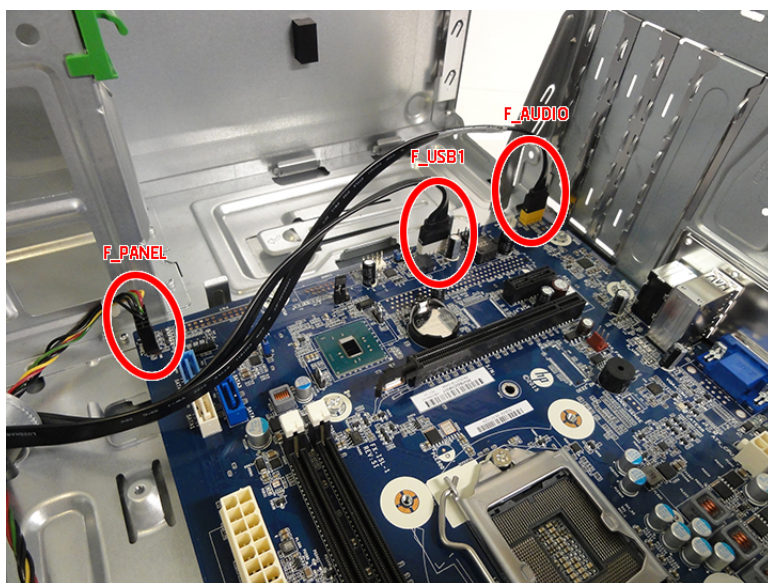

6. Remove the Torx screw **(1)** that secures the assembly to the chassis, push the tab on the right side of the assembly **(2)** to disengage it from the chassis, and push the assembly into the chassis **(3)**.

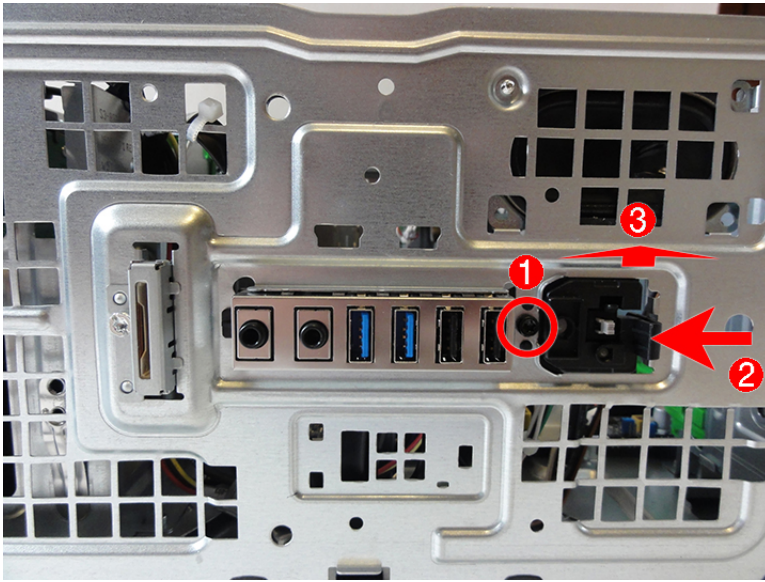

7. Remove the assembly from the inside of the computer.
To reinstall the assembly, reverse the removal procedure.

Speaker

1. Prepare the computer for disassembly ([Preparation for disassembly on page 17](#)).
2. Remove the access panel ([Access panel on page 18](#)).
3. Remove the front bezel ([Front bezel on page 19](#)).
4. From the outside, front of the chassis, remove the two Torx screws that secure the speaker to the chassis.

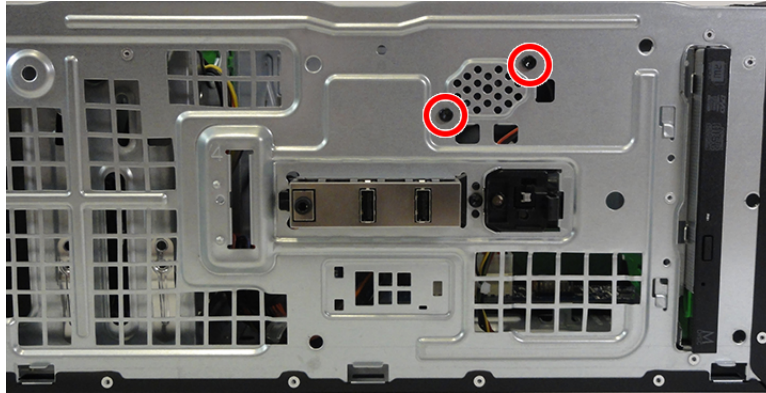

5. Disconnect the speaker wire from the system board connector labeled SPKR (1).
6. Remove the speaker from the chassis (2).

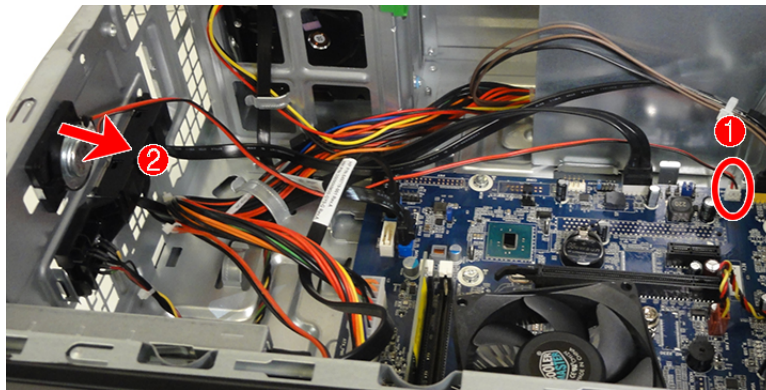

To replace the speaker, reverse the removal procedures.

Rear chassis fan

1. Prepare the computer for disassembly ([Preparation for disassembly on page 17](#)).
2. Remove the access panel ([Access panel on page 18](#)).
3. Remove the three silver Phillips screws that secure the fan to the rear of chassis.

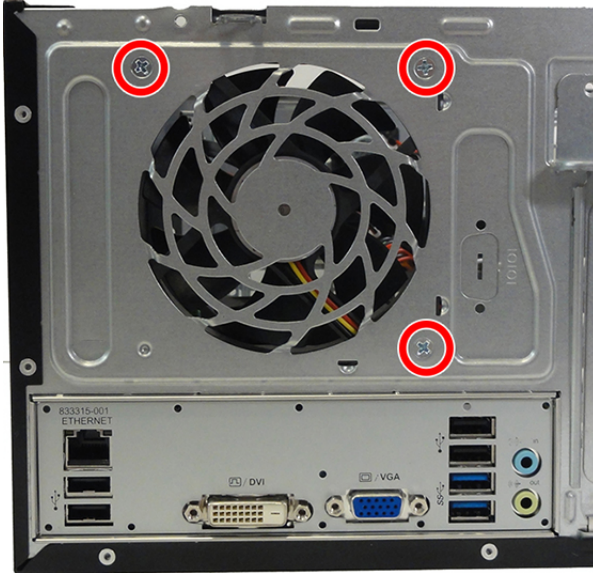

4. Disconnect the fan control cable (1) from the system board connector labeled SYS_FAN.
5. Lift the fan out of the chassis (2).

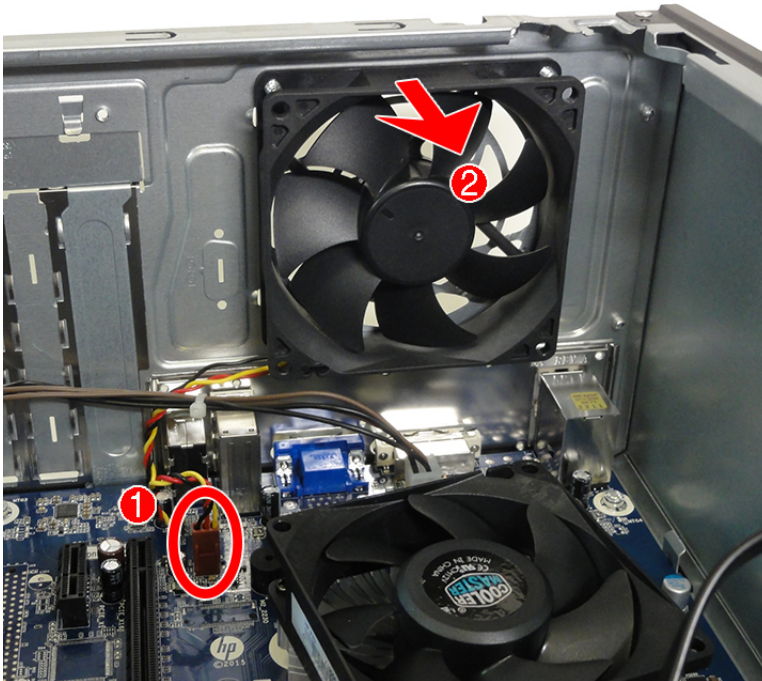

To install the fan assembly, reverse the removal procedure. Be sure to orient the air flow out of the unit.

Power supply

Description

300W, APFC (For use only in HP 280 G2 Microtower models in the People's Republic of China)

300W, Energy Star (For use only in HP 280 G2 Microtower models in the People's Republic of China)

180W, Energy Star

180W, Energy Star for use in the APJ region

180W, APFC

180W, standard (available only for NA, LA and APJ regions, except the People's Republic of China and India)

1. Prepare the computer for disassembly ([Preparation for disassembly on page 17](#)).
2. Remove the access panel ([Access panel on page 18](#)).
3. Remove the four silver Torx screws that connect the power supply to the rear of the chassis.

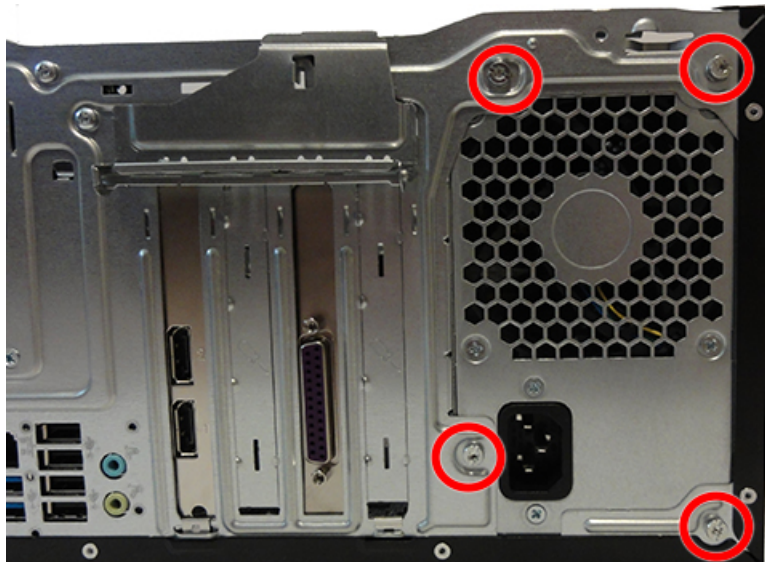

4. Remove the power cable from the clip on the base pan.

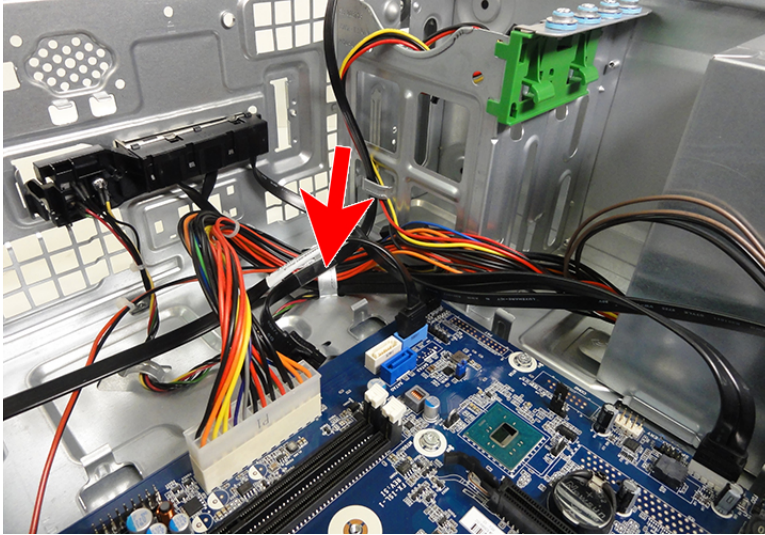

5. Disconnect the power supply cables from the following system board connectors:

ATX_CPU

ATX_PWR

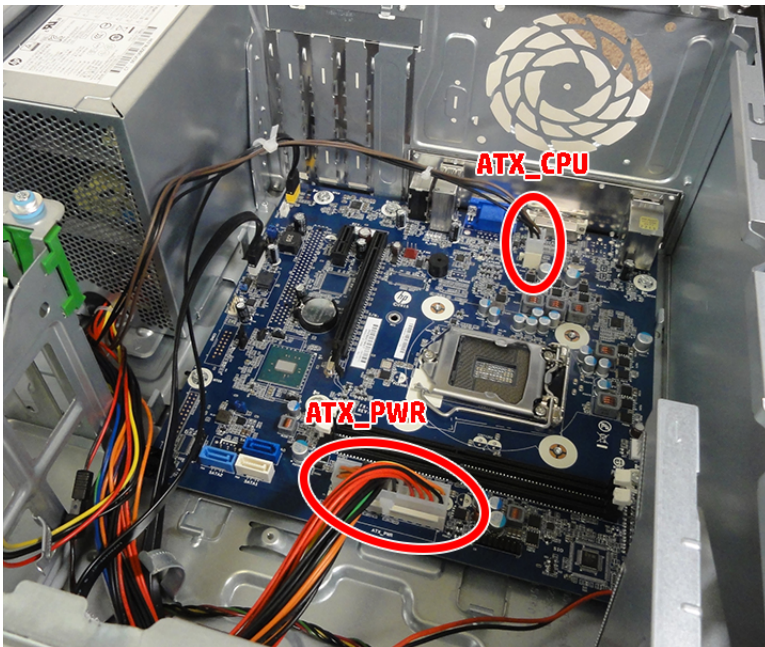

6. Press the tab (1) on the base pan in front of the power supply that holds it in place.

7. Slide the power supply toward the front of the computer, rotate toward the fan so the power supply clears the lip on the top of the chassis, and then lift the power supply out of the chassis **(2)**.

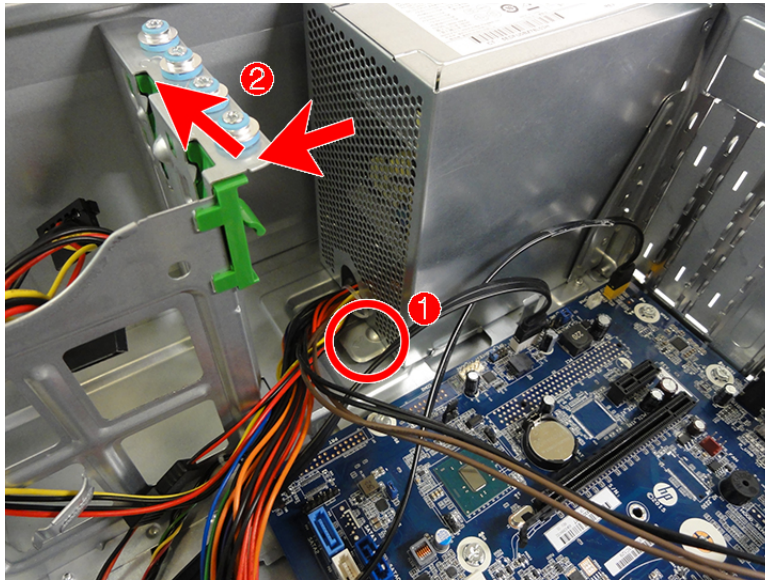

To install the power supply, reverse the removal procedure.

Fan sink

⚠ CAUTION: The bond between the fan sink and the processor may be very tight.

If the computer will power on, before removing the fan sink, turn on the computer until it warms the fan sink. Warming the fan sink lessens the bond between the heat sink and the processor, thereby making separating them easier.

Make sure not to pull the processor out of the socket when you lift the fan sink, especially if you cannot warm the fan sink prior to removal. Inadvertently removing the processor can damage the pins.

1. Prepare the computer for disassembly ([Preparation for disassembly on page 17](#)).
2. Remove the access panel ([Access panel on page 18](#)).
3. Loosen the four silver captive Torx screws (**1**) that secure the fan sink to the system board.

⚠ CAUTION: Remove fan sink retaining screws in diagonally opposite pairs (as in an X) to even the downward forces on the processor. The pins on the socket are very fragile and any damage to them may require replacing the system board.

4. Disconnect the fan cable from the system board connector labeled CPU_FAN (**2**).
5. Lift the heat sink from atop the processor.

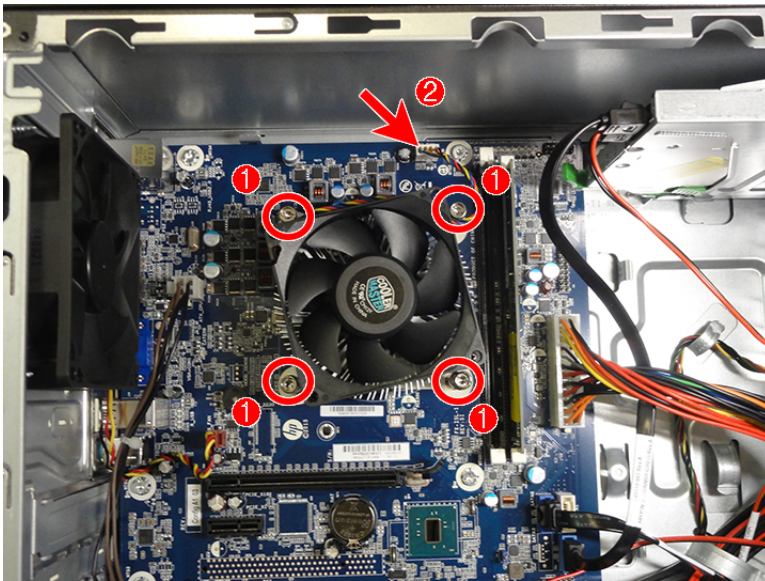

When reinstalling the fan sink, make sure that its bottom has been cleaned with an alcohol wipe and fresh thermal grease has been applied to the top of the processor.

⚠ CAUTION: Fan sink retaining screws should be tightened in diagonally opposite pairs (as in an X) to evenly seat the fan sink on the processor. This is especially important as the pins on the socket are very fragile and any damage to them may require replacing the system board.

Processor for use in HP 280 G2 models (Intel)

Description	Description
Intel Core i7-6700, 3.4 GHz	Intel Pentium G4520, 3.6 GHz
Intel Core i5-6600, 3.3 GHz	Intel Pentium G4500, 3.5 GHz
Intel Core i5-6500, 3.2 GHz	Intel Pentium G4400, 3.3 GHz
Intel Core i3-6320, 3.9 GHz	Intel Celeron G3920, 2.9 GHz
Intel Core i3-6300, 3.8 GHz	Intel Celeron G3900, 2.8 GHz
Intel Core i3-6100, 3.7 GHz	

1. Prepare the computer for disassembly ([Preparation for disassembly on page 17](#)).
2. Remove the access panel ([Access panel on page 18](#)).
3. Remove the fan sink ([Fan sink on page 44](#)).
4. Rotate the locking lever to its full open position **(1)**.
5. Raise and rotate the microprocessor retainer to its fully open position **(2)**.
6. Lift the processor **(3)** straight up and remove it.

CAUTION: Do NOT handle the pins in the processor socket. These pins are very fragile and handling them could cause irreparable damage. Once pins are damaged it may be necessary to replace the system board.

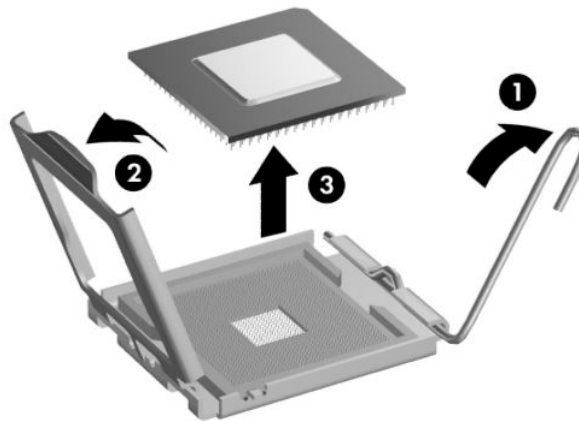

Reverse the removal procedure to install a new processor.

NOTE: After installing a new processor onto the system board, update the system ROM to ensure that the latest version of the BIOS is being used on the computer. The latest system BIOS can be found on the Web at: <http://h18000.www1.hp.com/support/files>.

Processor for use in HP 285 G2 models (AMD)

Description	Description
AMD A10-8750B, 3.6 GHz	AMD A6-6400B, 3.9 GHz
AMD A10-7800B, 3.57 GHz	AMD A6-5400B, 3.6 GHz
AMD A8-8650B, 3.2 GHz	AMD A4-7300B, 3.8 GHz
AMD A8-7600B, 3.1 GHz	AMD A4-6300B, 3.7 GHz
AMD A6-8550B, 3.7 GHz	AMD A4-5300B, 3.4 GHz
AMD A6-6420B, 4.0 GHz	

1. Prepare the computer for disassembly ([Preparation for disassembly on page 17](#)).
2. Remove the access panel ([Access panel on page 18](#)).
3. Remove the fan sink ([Fan sink on page 44](#)).
4. Rotate the locking lever to its full open position **(1)**.
5. Raise and rotate the microprocessor retainer to its fully open position **(2)**, and then carefully lift the processor from the socket **(3)**.

CAUTION: Do NOT handle the pins in the processor socket. These pins are very fragile and handling them could cause irreparable damage. Once pins are damaged it may be necessary to replace the system board.

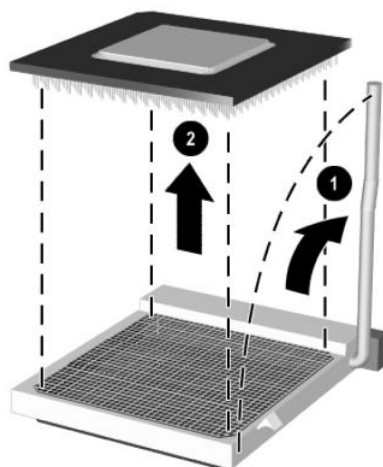

Reverse the removal procedure to install a new processor.



NOTE: After installing a new processor onto the system board, update the system ROM to ensure that the latest version of the BIOS is being used on the computer. The latest system BIOS can be found on the Web at: <http://h18000.www1.hp.com/support/files>.

System board

1. Prepare the computer for disassembly ([Preparation for disassembly on page 17](#)).
2. Remove the access panel ([Access panel on page 18](#)).
3. When replacing the system board, make sure the following components are removed from the defective system board and installed on the replacement system board:
 - Memory modules ([Memory on page 22](#))
 - Expansion cards ([Expansion cards on page 25](#))
 - Fan sink ([Fan sink on page 44](#)).
 - Processor ([Processor for use in HP 280 G2 models \(Intel\) on page 45](#))
4. Disconnect all cables connected to the system board, noting their location for reinstallation.
5. Remove the six Torx screws that secure the system board to the chassis.
6. Lift the system board up and out of the computer.

 **NOTE:** System board appearance may vary.

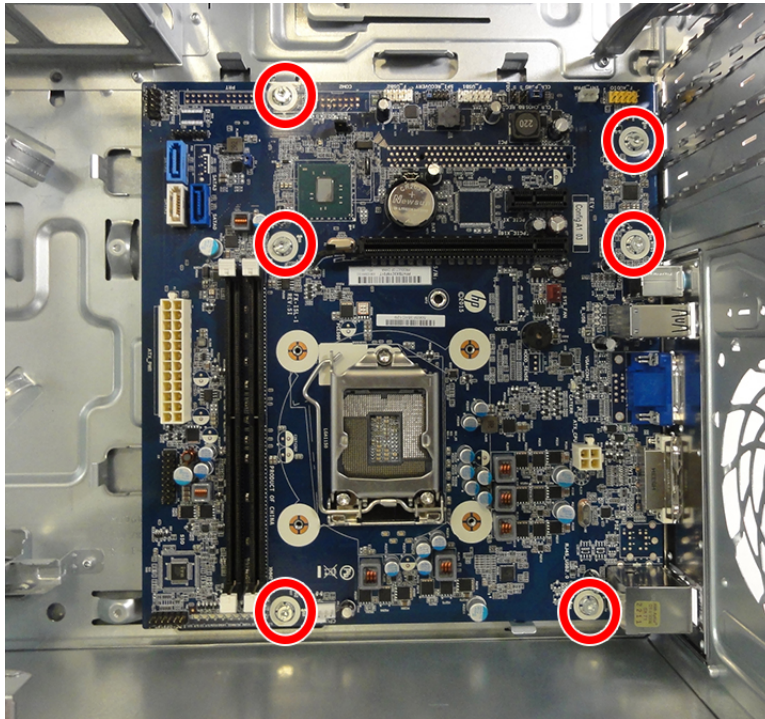

When reinstalling the system board, first insert the I/O panel back into the slots in the rear of the chassis, and then align the board with the chassis screw holes.

 **NOTE:** When replacing the system board, you must change the chassis serial number in the BIOS.

System board callouts – HP 280 Pro G2 Microtower models

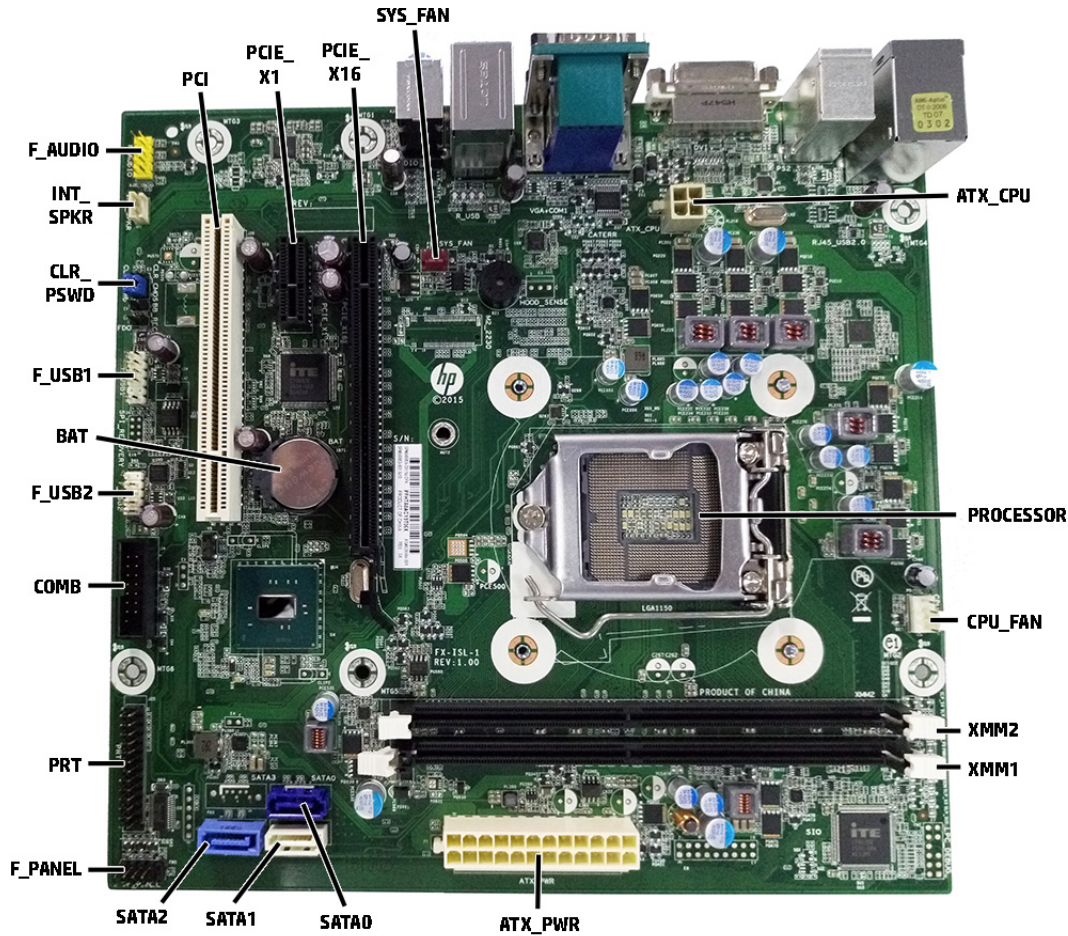

Sys Bd Label	Color	Component	Sys Bd Label	Color	Component
PCI	White	Expansion card	SATA1	White	Any SATA Device other than the primary hard drive
PCIE_X1	Black	Expansion card	SATA2	Light blue	Any SATA Device other than the primary hard drive
PCIE_X16	Black	Expansion card	F_PANEL	Black	Front I/O/power switch
SYS_FAN	Red	Chassis fan	PRT	Black	Optional printer port
ATX_CPU	White	4-pin processor power	COMB	Black	Optional serial port
PROCESSOR	Silver	Processor	F_USB2	White	Card reader
CPU_FAN	White	Processor fan	BAT	Black	RTC battery
XMM2	Black	Memory module	F_USB1	White	Front I/O
XMM1	Black	Memory module	CLR_PSWD	Black	Clear system passwords
ATX_PWR	White	24-pin main power	INT_SPKR	White	Internal speaker
SATA0	Dark blue	Primary hard drive	F_AUDIO	Yellow	Front I/O

System board callouts – HP 280 G2 Microtower models

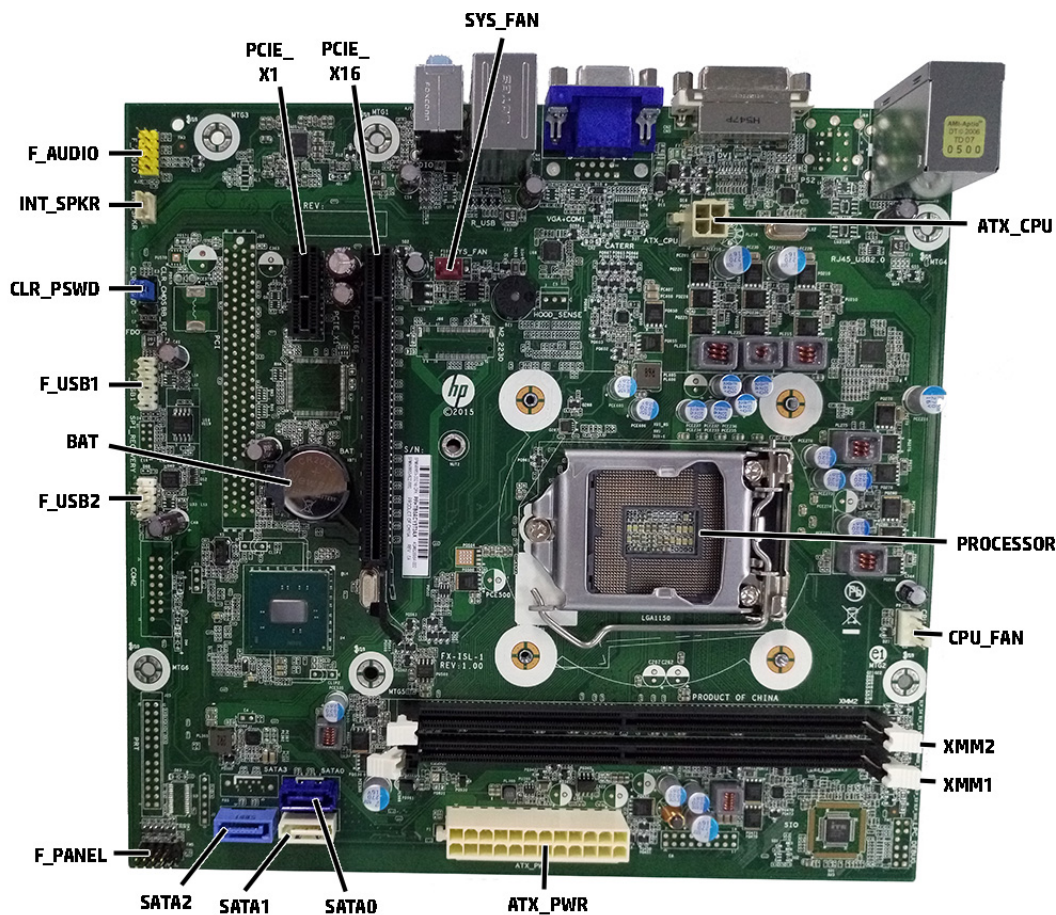

Sys Bd Label	Color	Component	Sys Bd Label	Color	Component
PCIE_X1	Black	Expansion card	SATA1	White	Any SATA Device other than the primary hard drive
PCIE_X16	Black	Expansion card	SATA2	Light blue	Any SATA Device other than the primary hard drive
SYS_FAN	Red	Chassis fan	F_PANEL	Black	Front IO/power switch
ATX_CPU	White	4-pin processor power	F_USB2	White	Card reader
PROCESSOR	Silver	Processor	BAT	Black	RTC battery
CPU_FAN	White	Processor fan	F_USB1	White	Front I/O
XMM2	Black	Memory module	CLR_PSWD	Black	Clear system passwords
XMM1	Black	Memory module	INT_SPKR	White	Internal speaker
ATX_PWR	White	24-pin main power	F_AUDIO	Yellow	Front I/O
SATA0	Dark blue	Primary hard drive			

System board callouts – HP 285 G2 Microtower models

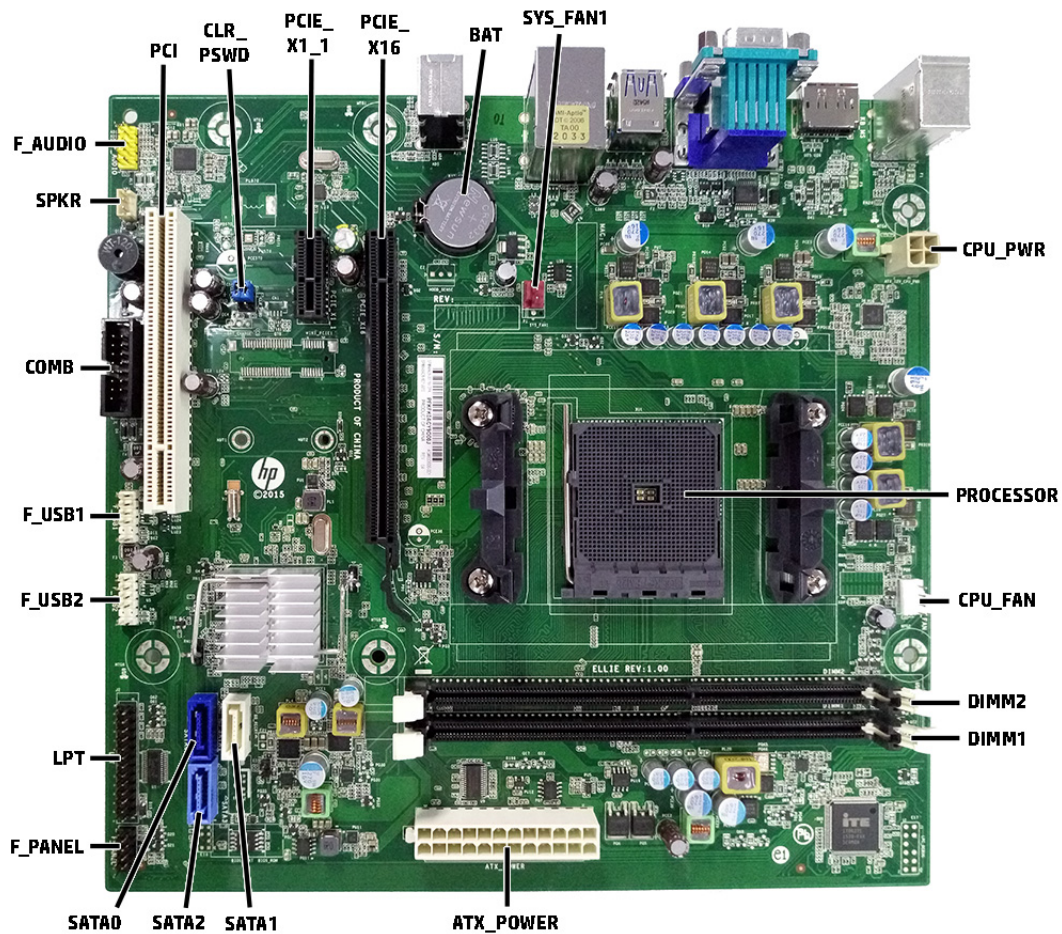

Sys Bd Label	Color	Component	Sys Bd Label	Color	Component
PCI	White	Expansion card	ATX_POWER	White	24-pin main power
CLR_PSWD	Black	Clear system passwords	SATA1	White	Any SATA Device other than the primary hard drive
PCIE_X1_1	Black	Expansion card	SATA2	Light blue	Any SATA Device other than the primary hard drive
PCIE_X16	Black	Expansion card	SATA0	Dark blue	Primary hard drive
BAT	Black	RTC battery	F_PANEL	Black	Front IO/power switch
SYS_FAN1	Red	Chassis fan	LPT	Black	Printer port connector
CPU_PWR	White	4-pin processor power	F_USB2	White	Card reader
PROCESSOR	Silver	Processor	F_USB1	White	Front I/O
CPU_FAN	White	Processor fan	COMB	Black	Optional second serial port
DIMM2	Black	Memory module	SPKR	White	Internal speaker
DIMM1	Black	Memory module	F_AUDIO	Yellow	Front I/O

5 Computer Setup (F10) Utility

Computer Setup (F10) Utilities

Use Computer Setup (F10) Utility to do the following:

- Change factory default settings.
- Set the system date and time.
- Set, view, change, or verify the system configuration, including settings for processor, graphics, memory, audio, storage, communications, and input devices.
- Modify the boot order of bootable devices such as hard drives, optical drives, or USB flash media devices.
- Enable Quick Boot, which is faster than Full Boot but does not run all of the diagnostic tests run during a Full Boot. You can set the system to:
 - always Fast Boot (default);
 - periodically Full Boot (from every 1 to 30 days); or
 - always Full Boot.
- Select Post Messages Enabled or Disabled to change the display status of Power-On Self-Test (POST) messages. Post Messages Disabled suppresses most POST messages, such as memory count, product name, and other non-error text messages. If a POST error occurs, the error is displayed regardless of the mode selected. To manually switch to Post Messages Enabled during POST, press any key (except **F1** through **F12**).
- Establish an Ownership Tag, the text of which is displayed each time the system is turned on or restarted.
- Enter the Asset Tag or property identification number assigned by the company to this computer.
- Enable the power-on password prompt during system restarts (warm boots) as well as during power-on.
- Establish a setup password that controls access to the Computer Setup (F10) Utility and the settings described in this section.
- Secure integrated I/O functionality, including the USB ports, audio, or embedded NIC, so that they cannot be used until they are unsecured.
- Enable or disable removable media boot ability.
- Solve system configuration errors detected but not automatically fixed during the Power-On Self-Test (POST).
- Replicate the system setup by saving system configuration information on a USB device and restoring it on one or more computers.
- Execute self-tests on a specified ATA hard drive (when supported by drive).
- Enable or disable DriveLock security (when supported by drive).

Using Computer Setup (F10) Utilities

Computer Setup can be accessed only by turning the computer on or restarting the system. To access the Computer Setup Utilities menu, complete the following steps:

1. Turn on or restart the computer.
2. Repeatedly press **F10** when the monitor light turns green to access the utility.

You can also press **Esc** to a menu that allows you to access different options available at startup, including the Computer Setup utility.



NOTE: If you do not press **F10** at the appropriate time, you must restart the computer and again repeatedly press **F10** when the monitor light turns green to access the utility.



NOTE: If the Computer Setup (F10) Utility is set to “fast boot”, use one of the following procedures to access Computer Setup:

- Before turning on the computer, press and hold **F10**. Turn on the computer and continue to hold **F10** until the Computer Setup (F10) Utility is displayed.
- or -
- Follow the Windows instructions for rebooting the computer into the Computer Setup (F10) Utility.

3. A choice of five headings appears in the Computer Setup Utilities menu: File, Storage, Security, Power, and Advanced.
4. Use the arrow (left and right) keys to select the appropriate heading. Use the arrow (up and down) keys to select the option you want, then press **Enter**. To return to the Computer Setup Utilities menu, press **Esc**.
5. To apply and save changes, select **File > Save Changes and Exit**.
 - If you have made changes that you do not want applied, select **Ignore Changes and Exit**.
 - To reset to factory settings or previously saved default settings (some models), select **Apply Defaults and Exit**. This option will restore the original factory system defaults.



NOTE: Not all settings shown in the following sections are available for all models



CAUTION: Do NOT turn the computer power OFF while the BIOS is saving the Computer Setup (F10) changes because the CMOS could become corrupted. It is safe to turn off the computer only after exiting the F10 Setup screen.

Computer Setup—File



NOTE: Support for specific Computer Setup options may vary depending on the hardware configuration.

Table 5-1 Computer Setup—File

Option	Description
System Information	Lists: <ul style="list-style-type: none">• Manufacturer• Product name• SKU number• Serial number• Asset Tag• Ownership Tag• Born on Date• System board ID and CT number• BIOS Revision• BIOS Revision• BIOS Date• Processor type and speed• Installed memory size/speed, number of channels (single or dual) (if applicable)
About	Displays copyright notice.
Set Time and Date	Allows you to set system time and date.
Default Setup	Save Current Settings as Default Saves the current system configuration settings as the default. Restore Factory Settings as Default Restores the factory system configuration settings as the default.
Apply Defaults and Exit	Applies the currently selected default settings and clears any established passwords.
Ignore Changes and Exit	Exits Computer Setup without applying or saving any changes.
Save Changes and Exit	Saves changes to system configuration or default settings and exits Computer Setup.

Computer Setup—Storage



NOTE: Support for specific Computer Setup options may vary depending on the hardware configuration.

Table 5-2 Computer Setup—Storage

Option	Description
Device Configuration	<p>Lists all installed BIOS-controlled storage devices.</p> <p>When a device is selected, detailed information and options are displayed. The following options may be presented:</p> <ul style="list-style-type: none">• Hard Disk: Size, model, firmware version, serial number.• CD-ROM: Model, firmware version, serial number.
Storage Options	<p>SATA Emulation</p> <p>Allows you to choose how the SATA controller and devices are accessed by the operating system. Supported options include: IDE and AHCI (default).</p> <p>CAUTION: SATA emulation changes may prevent access to existing hard drive data and degrade or corrupt established volumes.</p> <p>IDE Mode- This is the default and most backwards-compatible setting of the options. Operating systems usually do not require additional driver support in IDE mode. Use this option for "normal" (non-RAID) configurations</p> <p>AHCI Mode (default option) - Allows operating systems with AHCI device drivers loaded to take advantage of more advanced features of the SATA controller.</p> <p>Removable Media Boot</p> <p>Enables/disables ability to boot the system from removable media. Default is enabled.</p>
DPS Self-Test	<p>Allows you to execute self-tests on ATA hard drives capable of performing the Drive Protection System (DPS) self-tests.</p> <p>NOTE: This selection will only appear when at least one drive capable of performing the DPS self-tests is attached to the system.</p>
Boot Order	<p>Allows you to:</p> <ul style="list-style-type: none">• UEFI Boot Sources: Specify the order in which EFI boot sources (such as a internal hard drive, USB hard drive, USB optical drive, or internal optical drive) are checked for a bootable operating system image. Each device on the list may be individually excluded from or included for consideration as a bootable operating system source. <p>EFI boot sources always have precedence over legacy boot sources.</p> <ul style="list-style-type: none">• Legacy Boot Sources: Specify the order in which legacy boot sources (such as a network interface card, internal hard drive, USB optical drive, or internal optical drive) are checked for a bootable operating system image. Each device on the list may be individually excluded from or included for consideration as a bootable operating system source. <p>Specify the order of attached hard drives. The first hard drive in the order will have priority in the boot sequence and will be recognized as drive C (if any devices are attached).</p> <p>NOTE: To drag a device to a preferred place, press Enter. To remove the device from consideration as a bootable device, press F5.</p> <p>You can use F5 to disable individual boot items, as well as disable EFI boot and/or legacy boot.</p> <p>NOTE: MS-DOS drive lettering assignments may not apply after a non-MS-DOS operating system has started.</p> <p>Shortcut to Temporarily Override Boot Order</p> <p>To boot one time from a device other than the default device specified in Boot Order, restart the computer and press Esc (to access the boot menu) and then F9 (Boot Order), or only F9 (skipping the boot menu) when the monitor light turns green. After POST is completed, a list of bootable devices is displayed. Use the arrow keys to</p>

Table 5-2 Computer Setup—Storage (continued)

Option	Description
	select the preferred bootable device and press Enter . The computer then boots from the selected non-default device for this one time.

Computer Setup—Security



NOTE: Support for specific Computer Setup options may vary depending on the hardware configuration.

Table 5-3 Computer Setup—Security

Option	Description
Setup Password	Allows you to set and enable a setup (administrator) password. NOTE: If the setup password is set, it is required to change Computer Setup options, flash the ROM, and make changes to certain plug and play settings under Windows.
Power-On Password	Allows you to set and enable a power-on password. The power-on password prompt appears after a power cycle or reboot. If the user does not enter the correct power-on password, the unit will not boot.
Password Options (This selection appears only if a power-on password or setup password is set.)	Allows you to enable/disable: <ul style="list-style-type: none"> • Lock Legacy Resources (determines whether or not Windows Device Manager is allowed to change resource settings for serial and parallel ports). • Stringent security (enabling the stringent password disables the ability to reset the password by moving the jumper on the system board). Default is disabled. <p>CAUTION: If you enable the stringent security feature and you forget the setup password or the power-on password, the computer is inaccessible and can no longer be used.</p> <p>If you lose or forget the password, the system board must be replaced. This scenario is not covered under warranty.</p> <p>To prevent the computer from becoming permanently unusable, record your configured setup password or power-on password in a safe place away from your computer. Without these passwords, the computer cannot be unlocked.</p> <ul style="list-style-type: none"> • Setup Browse Mode (appears if a setup password is set) (allows viewing, but not changing, the F10 Setup Options without entering setup password). Default is enabled. • Password prompt on F9 & F12 (requires setup password to use these boot functions). Default is enabled. • Network Server Mode. Default is disabled.
Device Security	Allows you to set Device Available/Device Hidden (default is Device Available) for: <ul style="list-style-type: none"> • System audio • Network controller • SATA ports (varies by model)
USB Security	Allows you to set Enabled/Disabled (default is Enabled) for: <ul style="list-style-type: none"> • Front USB Ports • Rear USB Ports • Internal USB Ports
Slot Security	Allows you to disable any PCI Express slot. Default is enabled.

Table 5-3 Computer Setup—Security (continued)

Option	Description
Network Boot	Enables/disables the computer's ability to boot from an operating system installed on a network server. Default is enabled.
System IDs	<p>Allows you to set:</p> <ul style="list-style-type: none"> • Product Name • Serial Number • Universal Unique Identifier (UUID) number. The UUID can only be updated if the current chassis serial number is invalid. (These ID numbers are normally set in the factory and are used to uniquely identify the system.) • SKU Number • Family Name • Feature Byte. Default is enabled. • Build ID • Keyboard.
System Security (these options are hardware dependent)	<p>NOTE: Available options are displayed depending on system configuration.</p> <p>Virtualization Technology (VTx/VTd) (enable/disable) - Controls the virtualization features of the processor. Changing this setting requires turning the computer off and then back on. Default is disabled.</p> <p>Intel Software Guard Extensions (SGX) (Software controlled/enable/disable)</p> <p>TPM Features – Lets you configure the following TPM settings:</p> <p>TPM Device</p> <p>Lets you set the Trusted Platform Module as available or hidden.</p> <p>TPM State</p> <p>Select to enable the TPM.</p> <p>Clear TPM</p> <p>Select to reset the TPM to an unowned state. After the TPM is cleared, it is also turned off. To temporarily suspend TPM operations, turn the TPM off instead of clearing it.</p> <p>CAUTION: Clearing the TPM resets it to factory defaults and turns it off. You will lose all created keys and data protected by those keys.</p>
Secure Boot Configuration	<p>CAUTION: Changing the default setting of any of the Setup options on this page for operating systems that do not support Secure Boot may prevent the system from booting successfully.</p> <ul style="list-style-type: none"> • Legacy Support—Enable/Disable. Allows you to turn off all legacy support on the computer, including booting to DOS, running legacy graphics cards, booting to legacy devices, and so on. If set to disable, legacy boot options in Storage > Boot Order are not displayed. Default is enabled. • Secure Boot—Enable/Disable. Allows you to make sure an operating system is legitimate before booting to it, making Windows resistant to malicious modification from preboot to full OS booting, preventing firmware attacks. UEFI and Windows Secure Boot only allow code signed by pre-approved digital certificates to run during the firmware and OS boot process. Default is disabled, except for Windows systems which have this setting enabled. Secure Boot enabled also sets Legacy Support to disabled. • Key Management—This option lets you manage the custom key settings. <ul style="list-style-type: none"> ◦ Clear Secure Boot Keys—Don't Clear/Clear. Allows you to delete any previously loaded custom boot keys. Default is Don't Clear. ◦ Key Ownership—HP Keys/Custom Keys. Selecting Custom Mode allows you to modify the contents of the secure boot signature databases and the platform key (PK) that verifies kernels

Table 5-3 Computer Setup—Security (continued)

Option	Description
	during system start up, allowing you to use alternative operating systems. Selecting HP Keys causes the computer boot using the preloaded HP-specific boot keys. Default is HP Keys.
	<ul style="list-style-type: none"> Fast Boot—Enable/Disable. Fast boot disables the ability to interrupt boot, such as pressing f keys to access items before the operating system loads. Default is disabled. <p>NOTE: If Windows detects a serious error, it will interrupt the boot process automatically and display advanced boot options.</p> <p>From Windows, you can press Shift and select Restart to access the screen that lets you boot to a device or troubleshoot your computer.</p>

Computer Setup—Power



NOTE: Support for specific Computer Setup options may vary depending on the hardware configuration.

Table 5-4 Computer Setup—Power

Option	Description
OS Power Management	<ul style="list-style-type: none"> Runtime Power Management—Enable/Disable. Allows certain operating systems to reduce processor voltage and frequency when the current software load does not require the full capabilities of the processor. Default is enabled. Idle Power Savings—Extended/Normal. Allows certain operating systems to decrease the processors power consumption when the processor is idle. Default is extended.
Hardware Power Management	<p>SATA Power Management – Enables or disables SATA bus and/or device power management. Default is enabled.</p> <p>S4/S5 Wake On LAN - Lets you set the computer to power on at the specified days/times set in the BIOS power-on. Default is disabled.</p>
Thermal	<p>Fan idle mode—This bar graph controls the minimum permitted fan speed.</p> <p>NOTE: This setting only changes the minimum fan speed. The fans are still automatically controlled.</p> <p>CPU Fan Speed—Shows the fan speed.</p>

Computer Setup—Advanced



NOTE: Support for specific Computer Setup options may vary depending on the hardware configuration.

Table 5-5 Computer Setup—Advanced (for advanced users)

Option	Heading
Power-On Options	<p>Allows you to set:</p> <ul style="list-style-type: none"> POST messages (enable/disable). Enabling this feature will cause the system to display POST error messages, which are error messages displayed on the monitor during the Power On Self Test if the BIOS encounters some kind of problem while starting the PC. A POST error message will only display on screen if the computer is capable of booting this far. If the POST detects an error before this point, a beep code is generated instead. Default is disabled. After Power Loss (off/on/previous state). Default is Power off. Setting this option to: <ul style="list-style-type: none"> Power off—causes the computer to remain powered off when power is restored. Power on—causes the computer to power on automatically as soon as power is restored.

Table 5-5 Computer Setup—Advanced (for advanced users) (continued)

	<ul style="list-style-type: none">◦ Previous state—causes the computer to power on automatically as soon as power is restored, if it was on when power was lost. <p>NOTE: If you turn off power to the computer using the switch on a power strip, you will not be able to use the suspend/sleep feature or the Remote Management features.</p> <ul style="list-style-type: none">• POST Delay (in seconds). Enabling this feature will add a user-specified delay to the POST process. This delay is sometimes needed for hard disks on some PCI cards that spin up very slowly, so slowly that they are not ready to boot by the time POST is finished. The POST delay also gives you more time to select F10 to enter Computer (F10) Setup. Default is None.
BIOS Power-On	Allows you to set the computer to turn on automatically at a time you specify.
Bus Options	Allows you to enable or disable: <ul style="list-style-type: none">• PCI SERR# Generation. Default is enabled.• PCI VGA Palette Snooping, which sets the VGA palette snooping bit in PCI configuration space; only needed when more than one graphics controller is installed. Default is disabled.
Device Options	Allows you to set: <ul style="list-style-type: none">• Num Lock State at Power-On (On/Off). Default is On.• Printer Mode (Bi-directional/Output Only/EPP+ECP). Default is EPP+ECP.• Multi-Processor (enable/disable). Use this option to disable multi-processor support under the OS. Default is enabled.• Internal Speaker (enable/disable). Use this option to enable the internal speaker.• NIC PXE Option ROM Download (enable, disable). The BIOS contains an embedded NIC option ROM to allow the unit to boot through the network to a PXE server. This is typically used to download a corporate image to a hard drive. The NIC option ROM takes up memory space below 1MB commonly referred to as DOS Compatibility Hole (DCH) space. This space is limited. This F10 option will allow users to disable the downloading of this embedded NIC option ROM thus giving more DCH space for additional PCI cards which may need option ROM space. The default is-enabled.

Recovering the Configuration Settings

This method of recovery requires that you first perform the **Save to Removable Media** command with the Computer Setup (F10) Utility before **Restore** is needed. (See [Computer Setup—File on page 53](#) in the Computer Setup—File table.)



NOTE: It is recommended that you save any modified computer configuration settings to a USB flash media device and save the device for possible future use.

To restore the configuration, insert the USB flash media device with the saved configuration and perform the **Restore from Removable Media** command with the Computer Setup (F10) Utility. (See [Computer Setup—File on page 53](#) in the Computer Setup—File table.)

6 Troubleshooting without diagnostics

This chapter provides information on how to identify and correct minor problems, such as USB devices, hard drive, optical drive, graphics, audio, memory, and software problems. If you encounter problems with the computer, refer to the tables in this chapter for probable causes and recommended solutions.

 **NOTE:** For information on specific error messages that may appear on the screen during Power-On Self-Test (POST) at startup, refer to [POST error messages and diagnostic front panel LEDs and audible codes on page 89](#).

Safety and comfort

 **WARNING!** Misuse of the computer or failure to establish a safe and comfortable work environment may result in discomfort or serious injury. Refer to the *Safety & Comfort Guide* at <http://www.hp.com/ergo> for more information on choosing a workspace and creating a safe and comfortable work environment. For more information, refer to the *Safety & Regulatory Information* guide.

Before you call for technical support

If you are having problems with the computer, try the appropriate solutions below to try to isolate the exact problem before calling for technical support.

- Run the HP diagnostic tool.
- Run the hard drive self-test in Computer Setup. Refer to [Computer Setup \(F10\) Utility on page 51](#) for more information.
- Check the Power LED on the front of the computer to see if it is flashing red. The flashing lights are error codes that will help you diagnose the problem. Refer to [POST error messages and diagnostic front panel LEDs and audible codes on page 89](#) for more information.
- If the screen is blank, plug the monitor into a different video port on the computer if one is available. Or, replace the monitor with a monitor that you know is functioning properly.
- If you are working on a network, plug another computer with a different cable into the network connection. There may be a problem with the network plug or cable.
- If you recently added new hardware, remove the hardware and see if the computer functions properly.
- If you recently installed new software, uninstall the software and see if the computer functions properly.
- Boot the computer to the Safe Mode to see if it will boot without all of the drivers loaded. When booting the operating system, use “Last Known Configuration.”
- Refer to the comprehensive online technical support at <http://www.hp.com/support>.
- Refer to [Helpful hints on page 60](#) in this guide.

To assist you in resolving problems online, HP Instant Support Professional Edition provides you with self-solve diagnostics. If you need to contact HP support, use HP Instant Support Professional Edition's online chat feature. Access HP Instant Support Professional Edition at: <http://www.hp.com/go/ispe>.

Access the Business Support Center (BSC) at <http://www.hp.com/go/bizsupport> for the latest online support information, software and drivers, proactive notification, and worldwide community of peers and HP experts.

If it becomes necessary to call for technical assistance, be prepared to do the following to ensure that your service call is handled properly:

- Be in front of your computer when you call.
- Write down the computer serial number, product ID number, and monitor serial number before calling.
- Spend time troubleshooting the problem with the service technician.
- Remove any hardware that was recently added to your system.
- Remove any software that was recently installed.
- Restore the system from the Recovery Disc Set that you created or restore the system to its original factory condition in System Software Requirement Disks (SSRD).

 **CAUTION:** Restoring the system will erase all data on the hard drive. Be sure to back up all data files before running the restore process.

 **NOTE:** For sales information and warranty upgrades (Care Packs), call your local authorized service provider or dealer.

Helpful hints

If you encounter problems with the computer, monitor, or software, see the following list of general suggestions before taking further action:

- Check that the computer and monitor are plugged into a working electrical outlet.
- Check that the voltage select switch (some models) is set to the appropriate voltage for your region (115V or 230V).
- Check that the computer is turned on and the white power light is on.
- Check that the monitor is turned on and the green monitor light is on.
- Check the Power LED on the front of the computer to see if it is flashing red. The flashing lights are error codes that will help you diagnose the problem. Refer to [POST error messages and diagnostic front panel LEDs and audible codes on page 89](#) for more information.
- Turn up the brightness and contrast controls of the monitor if the monitor is dim.
- Press and hold any key. If the system beeps, then the keyboard should be operating correctly.
- Check all cable connections for loose connections or incorrect connections.
- Wake the computer by pressing any key on the keyboard or pressing the power button. If the system remains in suspend mode, shut down the computer by pressing and holding the power button for at least four seconds then press the power button again to restart the computer. If the system will not shut down, unplug the power cord, wait a few seconds, then plug it in again. The computer will restart if it is set to power on automatically as soon as power is restored in Computer Setup. If it does not restart, press the power button to start the computer.
- Reconfigure the computer after installing a non-plug and play expansion board or other option. See [Solving hardware installation problems on page 78](#) for instructions.
- Be sure that all the needed device drivers have been installed. For example, if you are using a printer, you need a driver for that model printer.
- Remove all bootable media (CD/DVD or USB device) from the system before turning it on.

- If you have installed an operating system other than the factory-installed operating system, check to be sure that it is supported on the system.
- If the system has multiple video sources (embedded, PCI, or PCI-Express adapters) installed (embedded video on some models only) and a single monitor, the monitor must be plugged into the monitor connector on the source selected as the primary VGA adapter. During boot, the other monitor connectors are disabled and if the monitor is connected into these ports, the monitor will not function. You can select which source will be the default VGA source in Computer Setup.

⚠ CAUTION: When the computer is plugged into an AC power source, there is always voltage applied to the system board. You must disconnect the power cord from the power source before opening the computer to prevent system board or component damage.

Solving general problems

You may be able to easily resolve the general problems described in this section. If a problem persists and you are unable to resolve it yourself or if you feel uncomfortable about performing the operation, contact an authorized dealer or reseller.

⚠ WARNING! When the computer is plugged into an AC power source, voltage is always applied to the system board. To reduce the risk of personal injury from electrical shock and/or hot surfaces, be sure to disconnect the power cord from the wall outlet and allow the internal system components to cool before touching.

Cannot access the Computer Setup (F10) Utility when booting the computer.

Cause	Solution
The Computer Setup (F10) Utility is set to “fast boot” causing the F10 access screen to display too briefly when booting the computer.	<p>Before turning on the computer, press and hold F10. Turn on the computer and continue to hold F10 until the Computer Setup (F10) Utility is displayed.</p> <p>- or -</p> <p>Follow the Windows instructions for rebooting the computer into the Computer Setup (F10) Utility.</p>

Computer appears locked up and will not turn off when the power button is pressed.

Cause	Solution
Software control of the power switch is not functional.	<ol style="list-style-type: none"> 1. Press and hold the power button for at least four seconds until the computer turns off. 2. Disconnect the power cord from the electrical outlet.

Computer will not respond to keyboard or mouse.

Cause	Solution
Computer is in Sleep state.	<p>To resume from Sleep state, press the power button.</p> <p>CAUTION: When attempting to resume from Sleep state, do not hold down the power button for more than four seconds. Otherwise, the computer will shut down and you will lose any unsaved data.</p>
System has locked up.	Restart computer.

Computer date and time display is incorrect.

Cause	Solution
RTC (real-time clock) battery may need to be replaced. NOTE: Connecting the computer to a live AC outlet prolongs the life of the RTC battery.	Reset the date and time under Control Panel (Computer Setup can also be used to update the RTC date and time). If the problem persists, replace the RTC battery. See the Removal and Replacement section for instructions on installing a new battery, or contact an authorized dealer or reseller for RTC battery replacement. To access Control Panel in Windows 7, select Start , and then select Control Panel . To access Control Panel in Windows 10, type <code>control panel</code> in the taskbar search box, and then select Control Panel.

Cursor will not move using the arrow keys on the keypad.

Cause	Solution
The Num Lock key is turned on.	Press the Num Lock key. The Num Lock light must be off if you want to use the arrow keys on the keypad. You can also disable or enable the Num Lock key in Computer Setup at Advanced > Device Options .

There is no sound or sound volume is too low.

Cause	Solution
System volume may be set low or muted.	<ol style="list-style-type: none">1. Check the Computer Setup settings to make sure the internal system speaker is not muted (this setting does not affect the external speakers).2. Make sure the external speakers are properly connected and powered on and that the speakers' volume control is set correctly.3. Use the system volume control available in the operating system to make sure the speakers are not muted or to increase the volume.

Cannot remove computer cover or access panel.

Cause	Solution
Smart Cover Lock, featured on some computers, is locked.	Unlock the Smart Cover Lock using Computer Setup. In case of forgotten password, power loss, or computer malfunction, you must manually disable the Smart Cover lock . A key to unlock the Smart Cover Lock is not available from HP. Keys are typically available from a hardware store.

Poor performance.

Cause	Solution
Processor is too hot.	<ol style="list-style-type: none">1. Make sure airflow to the computer is not blocked. Leave a 10.2-cm (4-inch) clearance on all vented sides of the computer and above the monitor to permit the required airflow.2. Make sure fans are connected and working properly (some fans only operate when needed).3. Make sure the processor heat sink is installed properly.
Hard drive is full.	Transfer data from the hard drive to create more space on the hard drive.
Low on memory.	Add more memory.
Hard drive fragmented.	Defragment hard drive.
Program previously accessed did not release reserved memory back to the system.	Restart the computer.
Virus resident on the hard drive.	Run virus protection program.
Too many applications running.	<ol style="list-style-type: none">1. Close unnecessary applications to free up memory.2. Add more memory.3. Some applications run in the background and can be closed by right-clicking on their corresponding icons in the task tray. To prevent these applications from launching at startup: In Windows 7:<ol style="list-style-type: none">a. Go to Start > All Programs > Accessories > Runb. Type <code>msconfig</code>, and then press Enter.c. On the Startup tab of the System Configuration Utility, clear applications that you do not want to launch automatically, and then click OK. In Windows 10:<ol style="list-style-type: none">a. Type <code>msconfig</code> in the taskbar search box, and then select msconfig.b. On the Startup tab of the System Configuration Utility, click Open Task Manager.c. Select applications that you do not want to launch automatically, and then click Disable.
Some software applications, especially games, are stressful on the graphics subsystem.	<ol style="list-style-type: none">1. Lower the display resolution for the current application or consult the documentation that came with the application for suggestions on how to improve performance by adjusting parameters in the application.2. Add more memory.3. Upgrade the graphics solution.
Cause unknown.	Restart the computer.

Computer powered off automatically and the Power LED flashes red four times and then white two times.

Cause	Solution
Processor thermal protection activated: A fan may be blocked or not turning. OR The heat sink is not properly attached to the processor.	<ol style="list-style-type: none">1. Ensure that the computer air vents are not blocked and the processor cooling fan is running.2. Open the access panel, press the power button, and see if the processor fan (or other system fan) spins. If the fan does not spin, make sure the fan cable is plugged onto the system board header.3. If fan a plugged in and not spinning, replace it.

System does not power on and the LEDs on the front of the computer are not flashing.

Cause	Solution
System unable to power on.	<p>Press and hold the power button for less than 4 seconds. If the hard drive LED turns white, then:</p> <ol style="list-style-type: none">1. If equipped with a voltage selector, check that the voltage selector (located on the rear of the power supply) is set to the appropriate voltage. Proper voltage setting depends on your region.2. Remove the expansion cards one at a time until the 5V_aux light on the system board turns on.3. Replace the system board. <p>OR</p> <p>Press and hold the power button for less than 4 seconds. If the hard drive LED does not turn on white then:</p> <ol style="list-style-type: none">1. Check that the unit is plugged into a working AC outlet.2. Open the access panel and check that the power button cable is properly connected to the system board.3. Check that the power supply cables are properly connected to the system board.4. Check to see if the 5V_aux light on the system board is turned on. If it is turned on, then replace the power button assembly.5. If the 5V_aux light on the system board is off, then replace the power supply.6. Replace the system board.

Solving power problems

Common causes and solutions for power problems are listed in the following table.

Power supply shuts down intermittently.

Cause	Solution
If equipped with a voltage selector, voltage selector switch on rear of computer chassis (some models) not switched to correct line voltage (115V or 230V).	Select the proper AC voltage using the selector switch.
Power supply will not turn on because of internal power supply fault.	Replace the power supply.

Computer powered off automatically and the Power LED flashes Red two times, once every second, followed by a two second pause, and the computer beeps two times. (Beeps stop after fifth iteration but LEDs continue flashing.)

Computer powered off automatically and the Power LED flashes red four times and then white two times.

Cause	Solution
Processor thermal protection activated: A fan may be blocked or not turning. OR The heat sink is not properly attached to the processor.	<ol style="list-style-type: none">1. Ensure that the computer air vents are not blocked and the processor cooling fan is running.2. Open the access panel, press the power button, and see if the processor fan (or other system fan) spins. If the fan does not spin, make sure the fan cable is plugged onto the system board header.3. If fan a plugged in and not spinning, replace it.

Power LED flashes Red four times, once every second, followed by a two second pause, and the computer beeps four times. (Beeps stop after fifth iteration but LEDs continue flashing.)

Computer powered off automatically and the Power LED flashes red three times and then white four times.

Cause	Solution
Power failure (power supply is overloaded).	<ol style="list-style-type: none">1. If equipped with a voltage selector, check that the voltage selector, located on the rear of the power supply (some models), is set to the appropriate voltage. Proper voltage setting depends on your region.2. Open the access panel and ensure the power supply cable is seated into the connector on the system board.3. Check if a device is causing the problem by removing ALL attached devices (such as hard drives or optical drives and expansion cards). Power on the system. If the system enters POST, then power off and replace one device at a time and repeat this procedure until failure occurs. Replace the device that is causing the failure. Continue adding devices one at a time to ensure all devices are functioning properly.4. Replace the power supply.5. Replace the system board.

Solving hard drive problems

Hard drive error occurs.

Cause	Solution
Hard disk has bad sectors or has failed.	<ol style="list-style-type: none">1. In Windows 7, click Start, click Computer, and right-click on a drive. Select Properties, and then select the Tools tab. Under Error-checking click Check Now. In Windows 10, type <code>file</code> in the taskbar search box, and then select File Explorer from the list of applications. In the left column, expand This PC, right-click on a drive, select Properties, and then select the Tools tab. Under Error checking click Check.2. Use a utility to locate and block usage of bad sectors. If necessary, reformat the hard disk.

Disk transaction problem.

Cause	Solution
Either the directory structure is bad or there is a problem with a file.	<p>In Windows 7, click Start, expand Computer, and right-click on a drive. Select Properties, and then select the Tools tab. Under Error-checking click Check Now.</p> <p>In Windows 10, type <code>file</code> in the taskbar search box, and then select File Explorer from the list of applications. In the left column, expand This PC, right-click on a drive, select Properties, and then select the Tools tab. Under Error checking click Check.</p>

Drive not found (identified).

Cause	Solution
Cable could be loose.	Check cable connections.
The system may not have automatically recognized a newly installed device.	<p>See reconfiguration directions in the Solving hardware installation problems on page 78 section. If the system still does not recognize the new device, check to see if the device is listed within Computer Setup. If it is listed, the probable cause is a driver problem. If it is not listed, the probable cause is a hardware problem.</p> <p>If this is a newly installed drive, run the Computer Setup utility and try adding a POST delay under Advanced > Power-On Options.</p>
The device is attached to a SATA port that has been hidden in Computer Setup.	Run the Computer Setup utility and ensure Device Available is selected for the device's SATA port in Security > Device Security .
Drive responds slowly immediately after power-up.	Run Computer Setup and increase the POST Delay in Advanced > Power-On Options .

Nonsystem disk/NTLDR missing message.

Cause	Solution
The system is trying to start from the hard drive but the hard drive may have been damaged.	▲ Perform Drive Protection System (DPS) testing in system ROM.
System files missing or not properly installed.	<ol style="list-style-type: none">1. Insert bootable media and restart the computer.2. Boot to the windows installation media and select the recovery option. If only a restore kit is available, then select the File Backup Program option, and then restore the system.3. Install system files for the appropriate operating system.
Hard drive boot has been disabled in Computer Setup.	Run the Computer Setup utility and enable the hard drive entry in the Storage > Boot Order list.
Bootable hard drive is not attached as first in a multi-hard drive configuration.	If attempting to boot from a hard drive, ensure it is attached to the system board dark blue SATA connector.
Bootable hard drive is not listed first in the Boot Order.	Run the Computer Setup utility and select Storage > Boot Order and ensure the bootable hard drive is listed immediately under the Hard Drive entry.

Computer will not boot from hard drive.

Cause	Solution
The device is attached to a SATA port that has been hidden in Computer Setup.	<ol style="list-style-type: none">1. Check SATA cable connections.2. Run the Computer Setup utility and ensure Device Available is selected for the device's SATA port in Security > Device Security.
Boot order is not correct.	Run the Computer Setup utility and change boot sequence in Storage > Boot Order .
Hard Drive's "Emulation Type" is set to "None." (some models)	Run the Computer Setup utility and change the "Emulation Type" to "Hard Disk" in the device's details under Storage > Device Configuration .
Hard drive is damaged.	Observe if the front panel Power LED is blinking RED and if any beeps are heard. See POST error messages and diagnostic front panel LEDs and audible codes on page 89 to determine possible causes for the blinking red and beep codes. See the Worldwide Limited Warranty for terms and conditions.

Computer seems to be locked up.

Cause	Solution
Program in use has stopped responding to commands.	<ol style="list-style-type: none">1. Use the task manager to close programs that do not respond.2. Attempt the normal Windows "Shut Down" procedure. If this fails, press the power button for four or more seconds to turn off the power. To restart the computer, press the power button again.

Solving media card reader problems

Media card will not work in a digital camera after formatting it in Windows.

Cause	Solution
By default, Windows will format any media card with a capacity greater than 32MB with the FAT32 format. Some digital cameras use the FAT (FAT16 & FAT12) format and can not operate with a FAT32 formatted card.	Either format the media card in the digital camera or select FAT file system to format the media card in a computer with Windows.

A write-protected or locked error occurs when attempting to write to the media card.

Cause	Solution
Media card is locked. Locking the media card is a safety feature that prevents writing to and deleting from an SD/Memory Stick/PRO card.	If using an SD card, make sure that the lock tab located on the right of the SD card is not in the locked position. If using a Memory Stick/PRO card, make sure that the lock tab located on the bottom of the Memory Stick/PRO card is not in the locked position.

Can not write to the media card.

Cause	Solution
The media card is a read-only memory (ROM) card.	Check the manufacturer's documentation included with your card to see if it writable. Refer to the previous section for a list of compatible cards.
Media card is locked. Locking the media card is a safety feature that prevents writing to and deleting from an SD/Memory Stick/PRO card.	If using an SD card, make sure that the lock tab located on the right of the SD card is not in the locked position. If using a Memory Stick/PRO card, make sure that the lock tab located on the bottom of the Memory Stick/PRO card is not in the locked position.

Unable to access data on the media card after inserting it into a slot.

Cause	Solution
The media card is not inserted properly, is inserted in the wrong slot, or is not supported.	Ensure that the card is inserted properly with the gold contact on the correct side. The green LED will light if inserted properly.

Do not know how to remove a media card correctly.

Cause	Solution
The computer's software is used to safely eject the card.	<p>In Windows 7, click Start, select Computer, right-click on the corresponding drive icon, and then select Eject. Pull the card out of the slot.</p> <p>In Windows 10, type <code>file</code> in the taskbar search box, and then select File Explorer from the list of applications. In the left column, expand This PC, right-click on the corresponding drive icon, and then select Eject. Pull the card out of the slot.</p> <p>NOTE: Never remove the card when the green LED is flashing</p>

After installing the media card reader and booting to Windows, the reader and the inserted cards are not recognized by the computer.

Cause	Solution
The operating system needs time to recognize the device if the reader was just installed into the computer and you are turning the PC on for the first time.	Wait a few seconds so that the operating system can recognize the reader and the available ports, and then recognize the media inserted in the reader.

After inserting a media card in the reader, the computer attempts to boot from the media card.

Cause	Solution
The inserted media card has boot capability.	<ol style="list-style-type: none">1. If you do not want to boot from the media card, remove it during boot or do not select the option to boot from the inserted media card during the boot process.2. During POST (Power On Self-Test), press F9 to modify the boot menu.3. Change the boot sequence in F10 Computer Setup.

Solving display problems

If you encounter display problems, see the documentation that came with the monitor and to the common causes and solutions listed in the following table.

Blank screen (no video).

Cause	Solution
Monitor is not turned on and the monitor light is not on.	Turn on the monitor and check that the monitor light is on.
Bad monitor.	Try a different monitor.
The cable connections are not correct.	Check the cable connection from the monitor to the computer and to the electrical outlet.
You may have a screen blanking utility installed or energy saver features are enabled.	Press any key or click the mouse button and type your password (if set).
System ROM is corrupted; system is running in Boot Block Emergency Recovery Mode (indicated by eight beeps).	Reflash the system ROM with the latest BIOS image.
You are using a fixed-sync monitor and it will not sync at the resolution chosen.	Be sure that the monitor can accept the same horizontal scan rate as the resolution chosen.
Computer is in Sleep state.	Press the power button to resume from Sleep state. CAUTION: When attempting to resume from Sleep state, do not hold down the power button for more than four seconds. Otherwise, the computer will shut down and you will lose any unsaved data.
Monitor cable is plugged into the wrong connector.	Systems may have a monitor connection on both the motherboard or an add-in card. Try moving the monitor connection to a different connector on the back of the computer
Monitor settings in the computer are not compatible with the monitor.	<ol style="list-style-type: none">1. In Control Panel, select Category from the View by list, then under Appearance and Personalization, select Adjust screen resolution.

Blank screen (no video).

Cause	Solution
	<p>To access Control Panel in Windows 7, click Start, and then select Control Panel.</p> <p>To access Control Panel in Windows 10, type <code>control panel</code> in the taskbar search box, and then select Control Panel from the list of applications.</p> <ol style="list-style-type: none">2. Expand the Resolution box, and then use the sliding control to reset the resolution.
Monitor is configured to use an input that is not active.	Use the monitor's on-screen menu controls to select the input that is being driven by the system. Refer to the monitor's user documentation for more information on the on-screen controls and settings.

Blank screen and the power LED flashes Red five times, once every second, followed by a two second pause, and the computer beeps five times. (Beeps stop after fifth iteration but LEDs continue flashing.)

Cause	Solution
Pre-video memory error.	<ol style="list-style-type: none">1. Reseat DIMMs. Power on the system.2. Replace DIMMs one at a time to isolate the faulty module.3. Replace third-party memory with HP memory.4. Replace the system board.

Blank screen and the power LED flashes Red six times, once every second, followed by a two second pause, and the computer beeps six times. (Beeps stop after fifth iteration but LEDs continue flashing.)

Cause	Solution
Pre-video graphics error.	<p>For systems with a graphics card:</p> <ol style="list-style-type: none">1. Reseat the graphics card (if applicable). Power on the system.2. Replace the graphics card (if applicable).3. Replace the system board. <p>For systems with integrated graphics, replace the system board.</p>

Blank screen and the power LED flashes Red seven times, once every second, followed by a two second pause, and the computer beeps seven times. (Beeps stop after fifth iteration but LEDs continue flashing.)

Cause	Solution
System board failure (ROM detected failure prior to video).	Replace the system board.

Monitor does not function properly when used with energy saver features.

Cause	Solution
Monitor without energy saver capabilities is being used with energy saver features enabled.	Disable monitor energy saver feature.

Dim characters.

Cause	Solution
The brightness and contrast controls are not set properly.	Adjust the monitor brightness and contrast controls.
Cables are not properly connected.	Check that the graphics cable is securely connected to the graphics card (if applicable) or video connector and the monitor.

Blurry video or requested resolution cannot be set.

Cause	Solution
If the graphics controller was upgraded, the correct graphics drivers may not be loaded.	Install the video drivers included in the upgrade kit.
Monitor is not capable of displaying requested resolution.	Change requested resolution.
Graphics card is bad.	Replace the graphics card.

The picture is broken up, rolls, jitters, or flashes.

Cause	Solution
The monitor connections may be incomplete or the monitor may be incorrectly adjusted.	<ol style="list-style-type: none">1. Be sure the monitor cable is securely connected to the computer.2. In a two-monitor system or if another monitor is in close proximity, be sure the monitors are not interfering with each other's electromagnetic field by moving them apart.3. Fluorescent lights or fans may be too close to the monitor.
Monitor needs to be degaussed.	Degauss the monitor. Refer to the documentation that came with the monitor for instructions.

Image is not centered.

Cause	Solution
Position may need adjustment.	Press the monitor's Menu button to access the OSD menu. Select ImageControl/ Horizontal Position or Vertical Position to adjust the horizontal or vertical position of the image.

“No Connection, Check Signal Cable” displays on screen.

Cause	Solution
Monitor video cable is disconnected.	Connect the video cable between the monitor and computer. CAUTION: Ensure that the computer power is off while connecting the video cable.

“Out of Range” displays on screen.

Cause	Solution
Video resolution and refresh rate are set higher than what the monitor supports.	Restart the computer and enter Safe Mode. Change the settings to a supported setting then restart the computer so that the new settings take effect. To enter Safe Mode in Windows 7: <ol style="list-style-type: none">1. Restart the computer.2. Press and hold the F8 key as your computer restarts, before the Windows logo appears. If the Windows logo appears, you must restart the computer and try again.3. On the Advanced Boot Options screen, use the arrow keys to highlight the safe mode option you want, and then press Enter.4. Log on to your computer with a user account that has administrator rights. When your computer is in safe mode, Safe Mode displays in the corners of your monitor. To exit safe mode, restart your computer and let Windows start normally. To enter Safe Mode in Windows 10: <ol style="list-style-type: none">1. Log into the computer using an Administrator account.2. Type <code>msconfig</code> in the taskbar search box, and then select msconfig from the list of applications.3. Click the Boot tab, select Safe boot and then click OK.

High pitched noise coming from inside a flat panel monitor.

Cause	Solution
Brightness and/or contrast settings are too high.	Lower brightness and/or contrast settings.

Fuzzy focus; streaking, ghosting, or shadowing effects; horizontal scrolling lines; faint vertical bars; or unable to center the picture on the screen (flat panel monitors using an analog VGA input connection only).

Cause	Solution
Flat panel monitor's internal digital conversion circuits may be unable to correctly interpret the output synchronization of the graphics card.	<ol style="list-style-type: none">1. Select the monitor's Auto-Adjustment option in the monitor's on-screen display menu.2. Manually synchronize the Clock and Clock Phase on-screen display functions. To download a SoftPaq that will assist you

Fuzzy focus; streaking, ghosting, or shadowing effects; horizontal scrolling lines; faint vertical bars; or unable to center the picture on the screen (flat panel monitors using an analog VGA input connection only).

Cause	Solution
	with the synchronization, go to the following Web site, select the appropriate monitor, and download either SP32347 or SP32202: http://www.hp.com/support
Graphics card is not seated properly or is bad (some models).	<ol style="list-style-type: none">1. Reseat the graphics card.2. Replace the graphics card.

Certain typed symbols do not appear correct.

Cause	Solution
The font you are using does not support that particular symbol.	Use the Character Map to locate and select the appropriate symbol. You can copy the symbol from the Character Map into a document. In Windows 7, click Start , select All Programs , select Accessories , select System Tools , and then select Character Map . In Windows 10, type ch in the taskbar search box, and then select Character Map from the list of applications.

Solving audio problems

If the computer has audio features and you encounter audio problems, see the common causes and solutions listed in the following table.

Sound cuts in and out.

Cause	Solution
Processor resources are being used by other open applications.	Shut down all open processor-intensive applications.

Sound does not come out of the speaker or headphones.

Cause	Solution
Software volume control is turned down or muted.	Double-click the Speaker icon on the taskbar, then make sure that Mute is not selected and use the volume slider to adjust the volume.
Audio is hidden in Computer Setup.	Enable the audio in Computer Setup: Security > Device Security > System Audio .
The external speakers are not turned on.	Turn on the external speakers.
The audio device may be connected to the wrong jack.	Ensure that the device is connected to the correct jack on the computer. The rear audio jack output is the green receptacle. The speakers should be plugged into the line-out jack and the headphones should be plugged into the headphone jack.
External speakers plugged into the wrong audio jack on a recently installed sound card.	See the sound card documentation for proper speaker connection. The rear audio jack output is the green receptacle.

Sound does not come out of the speaker or headphones.

Cause	Solution
Headphones or devices connected to the line-out connector mute the internal speaker.	Turn on and use headphones or external speakers, if connected, or disconnect headphones or external speakers.
Computer is in Sleep state.	Press the power button to resume from Sleep state. CAUTION: When attempting to resume from Sleep state, do not hold down the power button for more than four seconds. Otherwise, the computer will shut down and you will lose any unsaved data.
Internal speaker is disabled in Computer Setup.	Enable the internal speaker in Computer Setup. Select Advanced > Device Options > Internal Speaker .
The application is set to use a different audio device than speakers.	Some graphics cards support audio over the DisplayPort connection (if applicable), so multiple audio devices may be listed in Device Manager. Make sure the correct device is being used. To access Device Manager in Windows 7, click Start , select Control Panel , and then select Device Manager . To access Device Manager in Windows 10, type <code>device manager</code> in the taskbar search box, and then select Device Manager from the list of applications.
Some applications can select which audio output device is used.	Make sure the application has selected the correct audio device.
The operating system controls may be set to use a different audio device as the default output device than what is expected.	Set the operating system to use the correct audio device.

Sound from headphones is not clear or muffled.

Cause	Solution
Headphones are plugged into the rear audio output connector. The rear audio output connector is for powered audio devices and is not designed for headphone use.	Plug the headphones into the headphone connector on the front of the computer.

Computer appears to be locked up while recording audio.

Cause	Solution
The hard disk may be full.	Before recording, make sure there is enough free space on the hard disk. You can also try recording the audio file in a compressed format.

Line-in jack is not functioning properly.

Cause	Solution
Jack has been reconfigured in the audio driver or application software.	In the audio driver or application software, reconfigure the jack or set the jack to its default value.

There is no sound or sound volume is too low.

Cause	Solution
The application is set to use a different audio device than speakers.	Some graphics cards support audio over the DisplayPort connection (if applicable), so multiple audio devices may be listed in Device Manager. Make sure the correct device is being used. To access Device Manager in Windows 7, click Start , select Control Panel , and then select Device Manager . To access Device Manager in Windows 10, type <code>device manager</code> in the taskbar search box, and then select Device Manager from the list of applications.
Some applications can select which audio output device is used.	Make sure the application has selected the correct audio device.
The operating system controls may be set to use a different audio device as the default output device than what is expected.	Set the operating system to use the correct audio device.

Solving printer problems

If you encounter printer problems, see the documentation that came with the printer and to the common causes and solutions listed in the following table.

Printer will not print.

Cause	Solution
Printer is not turned on and online.	Turn the printer on and make sure it is online.
The correct printer drivers for the application are not installed.	<ol style="list-style-type: none">1. Install the correct printer driver for the application.2. Try printing using the MS-DOS command: <pre>DIR C:\ > [printer port]</pre>where [printer port] is the address of the printer being used. If the printer works, reload the printer driver. To run MS-DOS commands, press the Windows key + r, type <code>cmd</code> in the Open box, and then click OK.
If you are on a network, you may not have made the connection to the printer.	Make the proper network connections to the printer.
Printer may have failed.	Run printer self-test.

Printer will not turn on.

Cause	Solution
The cables may not be connected properly.	Reconnect all cables and check the power cord and electrical outlet.

Printer prints garbled information.

Cause	Solution
The correct printer driver for the application is not installed.	Install the correct printer driver for the application.
The cables may not be connected properly.	Reconnect all cables.
Printer memory may be overloaded.	Reset the printer by turning it off for one minute, then turn it back on.

Printer will not print.

Cause	Solution
The printer may be out of paper.	Check the paper tray and refill it if it is empty.

Solving keyboard and mouse problems

If you encounter keyboard or mouse problems, see the documentation that came with the equipment and to the common causes and solutions listed in the following table.

A wireless keyboard/mouse is not working correctly. Symptoms include lagging mouse movement, jumpy mouse/keyboard, or no function of mouse/keyboard and external drive.

Cause	Solution
If your computer is equipped with USB 3.0 ports, connected USB 3.0 devices can interfere with the wireless keyboard USB receiver.	Connect the wireless keyboard USB receiver to a USB 2.0 port that is separated from ports with USB 3.0 devices. If you still experience interference, you may have to place the connectors farther apart using an external USB hub.

Keyboard commands and typing are not recognized by the computer.

Cause	Solution
Keyboard connector is not properly connected.	Shut down the computer, reconnect the keyboard to the back of the computer, and then restart the computer.
Program in use has stopped responding to commands.	Shut down your computer using the mouse and then restart the computer.
Keyboard needs repairs.	See the Worldwide Limited Warranty for terms and conditions.
Computer is in Sleep state.	Press the power button to resume from Sleep state. CAUTION: When attempting to resume from Sleep state, do not hold down the power button for more than four seconds. Otherwise, the computer will shut down and you will lose any unsaved data.

Cursor will not move using the [arrow](#) keys on the keypad.

Cause	Solution
The Num Lock key is on.	Press the Num Lock key. The Num Lock light should be off if you want to use the arrow keys on the keypad. You can disable or enable the Num Lock key in Computer Setup at Advanced > Device Options .

Mouse does not respond to movement or is too slow.

Cause	Solution
Mouse connector is not properly plugged into the back of the computer.	Shut down the computer using the keyboard. Windows 7: <ol style="list-style-type: none">1. Press the Ctrl and Esc keys at the same time (or press the Windows logo key) to display the Start menu.2. Use the arrow keys to select Shut Down and then press Enter.3. After the shutdown is complete, plug the mouse connector into the back of the computer (or the keyboard) and restart. Windows 10: <ol style="list-style-type: none">1. Press the Ctrl and Esc keys at the same time (or press the Windows logo key) to display the Start menu.2. Use the arrow keys to scroll to and select the power icon at the top right on the menu, and then press Enter.3. Use the arrow keys to select Shut Down, and then press Enter.4. After the shutdown is complete, plug the mouse connector into the back of the computer (or the keyboard) and restart.
Program in use has stopped responding to commands.	Shut down the computer using the keyboard then restart the computer.
Mouse may need cleaning.	Remove the roller ball cover on the mouse and clean the internal components.
Mouse may need repair.	See the Worldwide Limited Warranty for terms and conditions.
Computer is in Sleep state.	Press the power button to resume from Sleep state. CAUTION: When attempting to resume from Sleep state, do not hold down the power button for more than four seconds. Otherwise, the computer will shut down and you will lose any unsaved data.

Mouse will only move vertically, horizontally, or movement is jerky.

Cause	Solution
Mouse roller ball or the rotating encoder shafts that make contact with the ball are dirty.	Remove roller ball cover from the bottom of the mouse and clean the internal components with a mouse cleaning kit available from most computer stores.

Solving hardware installation problems

You may need to reconfigure the computer when you add or remove hardware, such as an additional drive or expansion card. If you install a plug and play device, Windows automatically recognizes the device and configures the computer. If you install a non-plug and play device, you must reconfigure the computer after completing installation of the new hardware. In Windows, use the **Add Hardware Wizard** and follow the instructions that appear on the screen.

To open the Add Hardware Wizard, open a Command Prompt and open `hdwwiz.exe`.

⚠ WARNING! When the computer is plugged into an AC power source, voltage is always applied to the system board. To reduce the risk of personal injury from electrical shock and/or hot surfaces, be sure to disconnect the power cord from the wall outlet and allow the internal system components to cool before touching.

Table 6-1 Solving Hardware Installation Problems

A new device is not recognized as part of the system.

Cause	Solution
Device is not seated or connected properly.	Ensure that the device is properly and securely connected and that pins in the connector are not bent down.
Cable(s) of new external device are loose or power cables are unplugged.	Ensure that all cables are properly and securely connected and that pins in the cable or connector are not bent down.
Power switch of new external device is not turned on.	Turn off the computer, turn on the external device, then turn on the computer to integrate the device with the computer system.
When the system advised you of changes to the configuration, you did not accept them.	Reboot the computer and follow the instructions for accepting the changes.
A plug and play board may not automatically configure when added if the default configuration conflicts with other devices.	Use Windows Device Manager to deselect the automatic settings for the board and choose a basic configuration that does not cause a resource conflict. You can also use Computer Setup to reconfigure or disable devices to resolve the resource conflict. To access Device Manager in Windows 7, click Start , select Control Panel , and then select Device Manager . To access Device Manager in Windows 10, type <code>device manager</code> in the taskbar search box, and then select Device Manager from the list of applications.
USB ports on the computer are disabled in Computer Setup.	Run the Computer Setup utility and ensure that Device available is selected for appropriate USB ports under Security > USB Security .

Computer will not start.

Cause	Solution
Wrong memory modules were used in the upgrade or memory modules were installed in the wrong location.	<ol style="list-style-type: none">1. Review the documentation that came with the system to determine if you are using the correct memory modules and to verify the proper installation. NOTE: DIMM1 or XMM1 must always be installed. DIMM1 must be installed before DIMM2, and DIMM3 must be installed before DIMM4.

Computer will not start.

Cause	Solution
	<ol style="list-style-type: none">2. Observe the beeps and LED lights on the front of the computer. Beeps and flashing LEDs are codes for specific problems.3. If you still cannot resolve the issue, contact Customer Support.

Power LED flashes Red three times and then white two times.

Cause	Solution
Memory is installed incorrectly or is bad.	<p>CAUTION: To avoid damage to the DIMMs or the system board, you must unplug the computer power cord before attempting to reseat, install, or remove a DIMM module.</p> <ol style="list-style-type: none">1. Reseat DIMMs. Power on the system.2. Replace DIMMs one at a time to isolate the faulty module. <p>NOTE: DIMM1 or XMM1 must always be installed. DIMM1 must be installed before DIMM2, and DIMM3 must be installed before DIMM4</p> <ol style="list-style-type: none">3. Replace third-party memory with HP memory.4. Replace the system board.

Solving network problems

Some common causes and solutions for network problems are listed in the following table. These guidelines do not discuss the process of debugging the network cabling.

Network driver does not detect network controller.

Cause	Solution
Network controller is disabled.	<ol style="list-style-type: none">1. Run Computer Setup and enable network controller.2. Enable the network controller in the operating system using Device Manager. <p>To access Device Manager in Windows 7, click Start, select Control Panel, and then select Device Manager.</p> <p>To access Device Manager in Windows 10, type <code>device manager</code> in the taskbar search box, and then select Device Manager from the list of applications.</p>
Incorrect network driver.	Check the network controller documentation for the correct driver or obtain the latest driver from the manufacturer's Web site.

Network status link light never flashes.

NOTE: The network status light is supposed to flash when there is network activity.

Cause	Solution
No active network is detected.	Check cabling and network equipment for proper connection.
Network controller is not set up properly.	Check for the device status within Windows, such as Device Manager for driver load and the Network Connections applet within Windows for link status. To access Device Manager in Windows 7, click Start , select Control Panel , and then select Device Manager . To access Device Manager in Windows 10, type <code>device manager</code> in the taskbar search box, and then select Device Manager from the list of applications.
Network controller is disabled.	<ol style="list-style-type: none">1. Run Computer Setup and enable network controller.2. Enable the network controller in the operating system using Device Manager. To access Device Manager in Windows 7, click Start, select Control Panel, and then select Device Manager. To access Device Manager in Windows 10, type <code>device manager</code> in the taskbar search box, and then select Device Manager from the list of applications.
Network driver is not properly loaded.	Reinstall network drivers.
System cannot autosense the network.	Disable auto-sensing capabilities and force the system into the correct operating mode.

Diagnostics reports a failure.

Cause	Solution
The cable is not securely connected.	Ensure that the cable is securely attached to the network connector and that the other end of the cable is securely attached to the correct device.
The cable is attached to the incorrect connector.	Ensure that the cable is attached to the correct connector.
There is a problem with the cable or a device at the other end of the cable.	Ensure that the cable and device at the other end are operating correctly.
Network controller interrupt is shared with an expansion board.	Under the Computer Setup Advanced menu, change the resource settings for the board.
The network controller is defective.	Contact an authorized service provider.

Diagnostics passes, but the computer does not communicate with the network.

Cause	Solution
Network drivers are not loaded, or driver parameters do not match current configuration.	Make sure the network drivers are loaded and that the driver parameters match the configuration of the network controller.

Diagnostics passes, but the computer does not communicate with the network.

Cause	Solution
	Make sure the correct network client and protocol is installed.
The network controller is not configured for this computer.	Select the Network and Sharing Center icon in the Control Panel and configure the network controller. To access Control Panel in Windows 7, click Start , and then select Control Panel . To access Control Panel in Windows 10, type <code>control panel</code> in the taskbar search box, and then select Control Panel from the list of applications.

Network controller stopped working when an expansion board was added to the computer.

Cause	Solution
Network controller interrupt is shared with an expansion board.	Under the Computer Setup Advanced menu, change the resource settings for the board.
The network controller requires drivers.	Verify that the drivers were not accidentally deleted when the drivers for a new expansion board were installed.
The expansion board installed is a network card (NIC) and conflicts with the embedded NIC.	Under the Computer Setup Advanced menu, change the resource settings for the board.

Network controller stops working without apparent cause.

Cause	Solution
The files containing the network drivers are corrupted.	Reinstall the network drivers using the Recovery Disc Set in Windows 7. If necessary, download the softpaq from the web (from a different computer).
The cable is not securely connected.	Ensure that the cable is securely attached to the network connector and that the other end of the cable is securely attached to the correct device.
The network controller is defective.	Contact an authorized service provider.

New network card will not boot.

Cause	Solution
New network card may be defective or may not meet industry-standard specifications.	Install a working, industry-standard NIC, or change the boot sequence to boot from another source.

Cannot connect to network server when attempting Remote System Installation.

Cause	Solution
The network controller is not configured properly.	Verify Network Connectivity, that a DHCP Server is present, and that the Remote System Installation Server contains the NIC drivers for your NIC.

System setup utility reports unprogrammed EEPROM.

Cause	Solution
Unprogrammed EEPROM.	Contact an authorized service provider.

Solving memory problems

If you encounter memory problems, some common causes and solutions are listed in the following table.

 **CAUTION:** Power may still be supplied to the DIMMs when the computer is turned off (depending on the Management Engine (ME) settings). To avoid damage to the DIMMs or the system board, you must unplug the computer power cord before attempting to reseat, install, or remove a memory module.

For those systems that support ECC memory, HP does not support mixing ECC and non-ECC memory. Otherwise, the computer will not boot the operating system.

 **NOTE:** The memory count will be affected by configurations with the Management Engine (ME) enabled. The ME uses 8MB of system memory in single channel mode or 16MB of memory in dual-channel mode to download, decompress, and execute the ME firmware for Out-of-Band (OOB), third-party data storage, and other management functions.

System will not boot or does not function properly after installing additional memory modules.

Cause	Solution
A memory module is not installed in the DIMM1 or XMM1 socket.	Ensure that a memory module is installed in the DIMM1 or XMM1 socket on the system board. This socket must be populated with a memory module.
Memory module is not the correct type or speed grade for the system or the new memory module is not seated properly.	Replace module with the correct industry-standard device for the computer. On some models, ECC and non-ECC memory modules cannot be mixed.

Out of memory error.

Cause	Solution
You have run out of memory to run the application.	Check the application documentation to determine the memory requirements.

Memory count during POST is wrong.

Cause	Solution
The memory modules may not be installed correctly.	Check that the memory modules have been installed correctly and that proper modules are used.
Integrated graphics may use system memory.	No action required.

Insufficient memory error during operation.

Cause	Solution
Too many Terminate and Stay Resident programs (TSRs) are installed.	Delete any TSRs that you do not need.
You have run out of memory for the application.	Check the memory requirements for the application or add more memory to the computer.

Power LED flashes Red five times, once every second, followed by a two second pause, and the computer beeps five times. (Beeps stop after fifth iteration but LEDs continue flashing.)

Cause	Solution
Memory is installed incorrectly or is bad.	<ol style="list-style-type: none">1. Reseat DIMMs. Power on the system.2. Replace DIMMs one at a time to isolate the faulty module.3. Replace third-party memory with HP memory.4. Replace the system board.

Solving CD-ROM and DVD problems

If you encounter CD-ROM or DVD problems, see the common causes and solutions listed in the following table or to the documentation that came with the optional device.

System will not boot from CD-ROM or DVD drive.

Cause	Solution
The device is attached to a SATA port that has been hidden in the Computer Setup utility.	Run the Computer Setup utility and ensure Device Available is selected for the device's SATA port in Security > Device Security .
Removable Media Boot is disabled in the Computer Setup utility.	Run the Computer Setup utility and enable booting to removable media in Storage > Storage Options . Ensure CD-ROM is enabled in Storage > Boot Order .
Network Boot is enabled in Computer Setup.	Run the Computer Setup utility and disable Network Boot in Security > Network Boot .
Non-bootable CD in drive.	Try a bootable CD in the drive.
Boot order not correct.	Run the Computer Setup utility and change boot sequence in Storage > Boot Order .

Drive not found (identified).

Cause	Solution
Cable could be loose.	Check cable connections.
The system may not have automatically recognized a newly installed device.	See reconfiguration directions in the Solving hardware installation problems on page 78 section. If the system still does not recognize the new device, check to see if the device is listed within Computer Setup. If it is listed, the probable cause is a driver problem. If it is not listed, the probable cause is a hardware problem. If this is a newly installed drive, run the Computer Setup utility and try adding a POST delay under Advanced > Power-On Options .
The device is attached to a SATA port that has been hidden in Computer Setup.	Run the Computer Setup utility and ensure Device Available is selected for the device's SATA port in Security > Device Security .
Drive responds slowly immediately after power-up.	Run Computer Setup and increase the POST Delay in Advanced > Power-On Options .

CD-ROM or DVD devices are not detected or driver is not loaded.

Cause	Solution
Drive is not connected properly or not properly configured.	See the documentation that came with the optional device.

Movie will not play in the DVD drive.

Cause	Solution
Movie may be regionalized for a different country.	See the documentation that came with the DVD drive.
Decoder software is not installed.	Install decoder software.
Damaged media.	Replace media.
Movie rating locked out by parental lock.	Use DVD software to remove parental lock.
Media installed upside down.	Reinstall media.

Cannot eject compact disc (tray-load unit).

Cause	Solution
Disc not properly seated in the drive.	Turn off the computer and insert a thin metal rod into the emergency eject hole and push firmly. Slowly pull the tray out from the drive until the tray is fully extended, then remove the disc.

CD-ROM, CD-RW, DVD-ROM, or DVD-R/RW drive cannot read a disc or takes too long to start.

Cause	Solution
Media is corrupt.	Try different media to confirm whether media is valid.

CD-ROM, CD-RW, DVD-ROM, or DVD-R/RW drive cannot read a disc or takes too long to start.

Cause	Solution
Media has been inserted upside down.	Re-insert the media with the label facing up.
The DVD-ROM drive takes longer to start because it has to determine the type of media played, such as audio or video.	Wait at least 30 seconds to let the DVD-ROM drive determine the type of media being played. If the disc still does not start, read the other solutions listed for this topic.
CD or DVD disc is dirty.	Clean CD or DVD with a CD cleaning kit, available from most computer stores.
Windows does not detect the CD-ROM or DVD-ROM drive.	<ol style="list-style-type: none">1. Use Device Manager to remove or uninstall the device. To access Device Manager in Windows 7, click Start, select Control Panel, and then select Device Manager. To access Device Manager in Windows 10, type <code>device manager</code> in the taskbar search box, and then select Device Manager from the list of applications.2. Restart the computer and let Windows detect the CD or DVD driver.

Recording or copying CDs is difficult or impossible.

Cause	Solution
Wrong or poor quality media type.	<ol style="list-style-type: none">1. Try using a slower speed when recording.2. Verify that you are using the correct media for the drive.3. Try a different brand of media. Quality varies widely between manufacturers.

Solving USB flash drive problems

If you encounter USB flash drive problems, common causes and solutions are listed in the following table.

USB flash drive is not seen as a drive letter in Windows.

Cause	Solution
The drive letter after the last physical drive is not available.	Change the default drive letter for the flash drive in Windows.

USB flash drive not found (identified).

Cause	Solution
The device is attached to a USB port that has been hidden in Computer Setup.	Run the Computer Setup utility and enable USB ports in Security > USB Security .
The device was not properly seated before power-up.	Ensure the device is fully inserted into the USB port before applying power to the system

System will not boot from USB flash drive.

Cause	Solution
Boot order is not correct.	Run the Computer Setup utility and change boot sequence in Storage > Boot Order .
Removable Media Boot is disabled in the Computer Setup utility.	Run the Computer Setup utility and enable booting to removable media in Storage > Storage Options . Ensure USB is enabled in Storage > Boot Order .

The computer boots to DOS after making a bootable flash drive.

Cause	Solution
Flash drive is bootable.	Install the flash drive only after the operating system boots.
Flash drive is defective.	Try a different flash drive.

Solving front panel component problems

If you encounter problems with devices connected to the front panel, refer to the common causes and solutions listed in the following table.

A USB device, headphone, or microphone is not recognized by the computer.

Cause	Solution
Device is not properly connected.	<ol style="list-style-type: none">1. Turn off the computer.2. Reconnect the device to the front of the computer and restart the computer.
The device does not have power.	If the USB device requires AC power, be sure one end is connected to the device and one end is connected to a live outlet.
The correct device driver is not installed.	<ol style="list-style-type: none">1. Install the correct driver for the device.2. You might need to reboot the computer.
The cable from the device to the computer does not work.	<ol style="list-style-type: none">1. If possible, replace the cable.2. Restart the computer.
The device is not working.	<ol style="list-style-type: none">1. Replace the device.2. Restart the computer.
USB ports on the computer are disabled in Computer Setup.	Run the Computer Setup utility and ensure that the USB ports are set to Enabled in Security > USB Security .

Solving Internet access problems

If you encounter Internet access problems, consult your Internet Service Provider (ISP) or refer to the common causes and solutions listed in the following table.

Unable to connect to the Internet.

Cause	Solution
Internet Service Provider (ISP) account is not set up properly.	Verify Internet settings or contact your ISP for assistance.
Web browser is not set up properly.	Verify that the Web browser is installed and set up to work with your ISP.
Cable/DSL modem is not plugged in.	Plug in cable/DSL modem. You should see a “power” LED light on the front of the cable/DSL modem.
Cable/DSL service is not available or has been interrupted due to bad weather.	Try connecting to the Internet at a later time or contact your ISP. (If the cable/DSL service is connected, the “cable” LED light on the front of the cable/DSL modem will be on.)
The CAT5 UTP cable is disconnected.	Connect the CAT5 UTP cable between the cable modem and the computer’s RJ-45 connector. (If the connection is good, the “PC” LED light on the front of the cable/DSL modem will be on.)
IP address is not configured properly.	Contact your ISP for the correct IP address.
Cookies are corrupted. (A “cookie” is a small piece of information that a Web server can store temporarily with the Web browser. This is useful for having the browser remember some specific information that the Web server can later retrieve.)	Windows 7: <ol style="list-style-type: none">1. Select Start > Control Panel.2. Click Internet Options.3. In the Browsing history section on the General tab, click the Delete button.4. Select the Cookies check box and click the Delete button. Windows 10: <ol style="list-style-type: none">1. Type <code>control panel</code> in the taskbar search box, and then select Control Panel from the list of applications.2. Click Internet Options.3. In the Browsing history section, click the Delete button.4. Select the Cookies and website data check box and click the Delete button.

Cannot automatically launch Internet programs.

Cause	Solution
You must log on to your ISP before some programs will start.	Log on to your ISP and launch the desired program.

Solving software problems

Most software problems occur as a result of the following:

- The application was not installed or configured correctly.
- There is insufficient memory available to run the application.
- There is a conflict between applications.
- Be sure that all the needed device drivers have been installed.
- If you have installed an operating system other than the factory-installed operating system, check to be sure it is supported on the system.

If you encounter software problems, see the applicable solutions listed in the following table.

Computer will not continue and the HP logo does not display.

Cause	Solution
ROM issue - POST error has occurred.	Observe the beeps and LED lights on the front of the computer. See POST error messages and diagnostic front panel LEDs and audible codes on page 89 to determine possible causes. See the Worldwide Limited Warranty for terms and conditions.

“Illegal Operation has Occurred” error message is displayed.

Cause	Solution
Software being used is not Microsoft-certified for your version of Windows.	Verify that the software is certified by Microsoft for your version of Windows (see program packaging for this information).
Configuration files are corrupt.	If possible, save all data, close all programs, and restart the computer.

7 POST error messages and diagnostic front panel LEDs and audible codes

This appendix lists the error codes, error messages, and the various indicator light and audible sequences that you may encounter during Power-On Self-Test (POST) or computer restart, the probable source of the problem, and steps you can take to resolve the error condition.

POST Message Disabled suppresses most system messages during POST, such as memory count and non-error text messages. If a POST error occurs, the screen will display the error message. To manually switch to the POST Messages Enabled mode during POST, press any key (except **F10**, **F11**, or **F12**). The default mode is POST Message Disabled.

The speed at which the computer loads the operating system and the extent to which it is tested are determined by the POST mode selection.

Quick Boot is a fast startup process that does not run all of the system level tests, such as the memory test. Full Boot runs all of the ROM-based system tests and takes longer to complete.

Full Boot may also be enabled to run every 1 to 30 days on a regularly scheduled basis. To establish the schedule, reconfigure the computer to the Full Boot Every x Days mode, using Computer Setup.



NOTE: For more information on Computer Setup, see [Computer Setup \(F10\) Utility on page 51](#).

POST numeric codes and text messages

This section covers those POST errors that have numeric codes associated with them. The section also includes some text messages that may be encountered during POST.



NOTE: The computer will beep once after a POST text message is displayed on the screen.

Control panel message	Description	Recommended action
002-Option ROM Checksum Error	System ROM or expansion board option ROM checksum.	<ol style="list-style-type: none">1. Verify the correct ROM.2. Flash the ROM if needed.3. If an expansion board was recently added, remove it to see if the problem remains.4. Clear CMOS. (See Password security and resetting CMOS on page 96.)5. If the message disappears, there may be a problem with the expansion card.6. Replace the system board.
003-System Board Failure	DMA or timers.	<ol style="list-style-type: none">1. Clear CMOS. (See Password security and resetting CMOS on page 96.)2. Remove expansion boards.3. Replace the system board.
005-Real-Time Clock Power Loss	Invalid time or date in configuration memory.	Reset the date and time under Control Panel (Computer Setup can also be used). If the

Control panel message	Description	Recommended action
	RTC (real-time clock) battery may need to be replaced.	problem persists, replace the RTC battery. See the Removal and Replacement section for instructions on installing a new battery.
008—Microcode Patch Error	Processor is not supported by the BIOS.	<ol style="list-style-type: none"> 1. Upgrade BIOS to proper version. 2. Change the processor.
009—PMM Allocation Error during MEBx Download	Memory error during POST execution of the Management Engine (ME) BIOS Extensions option ROM.	<ol style="list-style-type: none"> 1. Reboot the computer. 2. Unplug the power cord, re-seat the memory modules, and reboot the computer. 3. If the memory configuration was recently changed, unplug the computer, restore the original memory configuration, and reboot the computer. 4. If the error persists, replace the system board.
100-Front Audio Not Connected	Front audio cable has been detached or unseated from system board.	Reconnect or replace front audio cable.
00A—Product Information Not Valid	The product information programmed into the system board is missing or invalid.	Use Computer Setup to update this information.
00B—MEBx Module did not checksum correctly	Memory error during POST execution of the Management Engine (ME) BIOS Extensions option ROM.	<ol style="list-style-type: none"> 1. Reboot the computer. 2. Unplug the power cord, re-seat the memory modules, and reboot the computer. 3. If the memory configuration was recently changed, unplug the power cord, restore the original memory configuration, and reboot the computer. 4. If the error persists, replace the system board.
00C—PMM Deallocation Error during MEBx Cleanup	Memory error during POST execution of the Management Engine (ME) BIOS Extensions option ROM.	<ol style="list-style-type: none"> 1. Reboot the computer. 2. Unplug the power cord, re-seat the memory modules, and reboot the computer. 3. If the memory configuration was recently changed, unplug the power cord, restore the original memory configuration, and reboot the computer. 4. If the error persists, replace the system board.
00D—Setup Error during MEBx Execution	MEBx selection or exit resulted in a setup failure.	<ol style="list-style-type: none"> 1. Reboot the computer. 2. Unplug the power cord, re-seat the memory modules, and reboot the computer. 3. If the memory configuration was recently changed, unplug the power cord, restore the original memory configuration, and reboot the computer.

Control panel message	Description	Recommended action
		<ol style="list-style-type: none"> 4. If the error persists, replace the system board.
00E-Inventory Error during MEBx Execution	BIOS information passed to the MEBx resulted in a failure.	<ol style="list-style-type: none"> 1. Reboot the computer. 2. If the error persists, update to the latest BIOS version. 3. If the error still persists, replace the system board.
00F-Interface Error during MEBx Execution	MEBx operation experienced a hardware error during communication with the ME.	<ol style="list-style-type: none"> 1. Reboot the computer. 2. If the error persists, update to the latest BIOS version. 3. If the error still persists, replace the system board.
2E1-MemorySize Error	Memory amount has changed since the last boot (memory added or removed).	The system memory size is different from the last startup. The most common reason is the removal of memory from the system board. Press the F1 key to save the memory changes. If this message persists, verify that the memory modules are installed correctly.
2E2-Memory Error	Memory module configuration failed during boot up.	<ol style="list-style-type: none"> 1. Ensure memory modules are correctly installed. 2. Verify proper memory module type. 3. Remove and replace the identified faulty memory module(s). 4. If the error persists after replacing memory modules, replace the system board.
2E3-Incompatible Memory Module in Memory Socket(s) X, X, ...	A memory module in memory socket identified in the error message is missing critical SPD information, or is incompatible with the chipset.	<ol style="list-style-type: none"> 1. Verify proper memory module type. 2. Try another memory socket. 3. Replace with a supported module.
2E4-DIMM Configuration Warning	The current memory configuration is not optimized.	Rearrange the DIMMs so that each channel has the same amount of memory.
2E5-ECC Memory Module Detected on Unsupported Platform	Recently added memory module(s) support ECC memory error correction.	<ol style="list-style-type: none"> 1. If additional memory was recently added, remove it to see if the problem remains. 2. Check product documentation for memory support information.
2E6-Memory Not Configured Correctly for Proper MEBx Execution	DIMM1 is not installed.	Make sure there is a memory module in the DIMM1 socket and that it is properly seated.
300-Configuration Change Warning	The storage device configuration will be updated as shown.	Not applicable
301-Hard Disk 1: SMART Hard Drive Detects Imminent Failure	Hard drive is about to fail. (Some hard drives have a hard drive firmware patch that will fix an erroneous error message.)	<ol style="list-style-type: none"> 1. Determine if hard drive is giving correct error message. Run the Drive Protection System test under using F2 Diagnostics when booting the computer. 2. Apply hard drive firmware patch if applicable. (Available at http://www.hp.com/support.)

Control panel message	Description	Recommended action
302-Hard Disk 2: SMART Hard Drive Detects Imminent Failure	Hard drive is about to fail. (Some hard drives have a hard drive firmware patch that will fix an erroneous error message.)	<ol style="list-style-type: none"> 1. Determine if hard drive is giving correct error message. Run the Drive Protection System test under using F2 Diagnostics when booting the computer. 2. Apply hard drive firmware patch if applicable. (Available at http://www.hp.com/support.) 3. Back up contents and replace hard drive.
309 – 30C: Hard Disk 3–6: SMART Hard Drive Detects Imminent Failure	Hard drive is about to fail. (Some hard drives have a hard drive firmware patch that will fix an erroneous error message.)	<ol style="list-style-type: none"> 1. Determine if hard drive is giving correct error message. Run the Drive Protection System test under using F2 Diagnostics when booting the computer. 2. Apply hard drive firmware patch if applicable. (Available at http://www.hp.com/support.) 3. Back up contents and replace hard drive.
3F0-Boot Device Not Found	Boot device not found.	Insert boot device or load operating system.
3F1-Hard Disk 1 Error	Hard disk 1 error.	<ol style="list-style-type: none"> 1. Check and/or replace cables. 2. Clear CMOS. (See Password security and resetting CMOS on page 96.) 3. Replace the hard disk drive.
3F2-Hard Disk 2 Error	Hard disk 2 error.	<ol style="list-style-type: none"> 1. Check and/or replace cables. 2. Clear CMOS. (See Password security and resetting CMOS on page 96.) 3. Replace the hard disk drive.
400-Serial Port A Address Conflict Detected	Both external and internal serial ports are assigned to the same resources.	<ol style="list-style-type: none"> 1. Remove any serial port expansion cards. 2. Clear CMOS. (See Password security and resetting CMOS on page 96.) 3. Reconfigure card resources and/or run Computer Setup or Windows utilities.
401-Serial Port B Address Conflict Detected	Both external and internal serial ports are assigned to the same resources.	<ol style="list-style-type: none"> 1. Remove any serial port expansion cards. 2. Clear CMOS. (See Password security and resetting CMOS on page 96.) 3. Reconfigure card resources and/or run Computer Setup or Windows utilities.
402-Serial Port C Address Conflict Detected	Both external and internal serial ports are assigned to the same resources.	<ol style="list-style-type: none"> 1. Remove any serial port expansion cards. 2. Clear CMOS. (See Password security and resetting CMOS on page 96.) 3. Reconfigure card resources and/or run Computer Setup or Windows utilities.
403-Serial Port D Address Conflict Detected	Both external and internal serial ports are assigned to the same resources.	<ol style="list-style-type: none"> 1. Remove any serial port expansion cards. 2. Clear CMOS. (See Password security and resetting CMOS on page 96.)

Control panel message	Description	Recommended action
		<ol style="list-style-type: none"> 3. Reconfigure card resources and/or run Computer Setup or Windows utilities.
419-Out of Memory Space for Option ROMs	Recently added PCI expansion card contains an option ROM too large to download during POST.	<ul style="list-style-type: none"> ▲ If a PCI expansion card was recently added, remove it to see if the problem remains.
41A-Front USB1/USB2 Not Connected	Front USB cable has been detached or unseated from system board.	Reconnect or replace front USB cable.
41B-Device in PCI Express Slot Failed To Initialize	There is an incompatibility or problem with a PCIe device and the system or PCIe link could not be configured to a valid bus width or speed.	Try rebooting the system. If the error reoccurs, the device may not work with this system
43A-USB Type-C I2C Not Connected	Cable is required between I2C on card and USB-C on the system board.	Install cable between I2C on card and USB-C on the system board.
43B-More Than One USB type-C Cards Are Installed	More than one USB type-C card is installed.	Remove USB type-C card so only one is installed.
500-BIOS Recovery	A system BIOS recovery has occurred.	Not applicable.
60x-HP Battery Alert	The system has detected the storage capacity of the battery stated below to be very low.	For optimal performance, replace the battery.
70x-Wireless Mode Not Supported	The system has detected a wireless module installed in the system that is not supported and has been disabled.	Replace with a supported module.
800-Keyboard Error	Keyboard failure.	<ol style="list-style-type: none"> 1. Reconnect keyboard with computer turned off. 2. Check connector for bent or missing pins. 3. Ensure that none of the keys are depressed. 4. Replace keyboard.
801-Keyboard or System Unit Error	Keyboard failure.	<ol style="list-style-type: none"> 1. Reconnect the keyboard with computer turned off. 2. Ensure that none of the keys are depressed. 3. Replace the keyboard. 4. Replace the system board.
900-CPU Fan Not Detected	CPU fan is not connected or may have malfunctioned.	<ol style="list-style-type: none"> 1. Reseat CPU fan. 2. Reseat fan cable. 3. Replace CPU fan.
901-Chassis, Rear Chassis, or Front Chassis Fan not Detected	Chassis, rear chassis, or front chassis fan is not connected or may have malfunctioned.	<ol style="list-style-type: none"> 1. Reseat chassis, rear chassis, or front chassis fan. 2. Reseat fan cable. 3. Replace chassis, rear chassis, or front chassis fan.
904-SATA Cabling Error	One or more SATA devices are improperly attached. For optimal performance, the SATA 0 and SATA 1 ports should be used for hard drives before other ports.	Ensure SATA connectors are used in ascending order. For one device, use SATA 0. For two devices, use SATA 0 and SATA 1. For three devices, use SATA 0, SATA 1, and SATA 2.

Control panel message	Description	Recommended action
910-Filter Warning	Airflow filter is dirty.	Replace the airflow filter.
90B-Fan Failure	The system has detected that a cooling fan is not operating correctly.	<ol style="list-style-type: none"> 1. Reseat fan. 2. Reseat fan cable. 3. Replace fan.
90D-System Temperature	Thermal shutdown occurred. The system BIOS has detected your machine was previously shut down to avoid overheating. Overheating may occur if the cooling vents are blocked or the operating temperature exceeds the system specifications. The machine should return to normal operation once the situation is resolved.	Make sure system has proper airflow.
90E-Power Supply Fan Not detected	Power supply fan is not connected or may have malfunctioned.	<ol style="list-style-type: none"> 1. Reseat power supply fan. 2. Reseat fan cable. 3. Replace power supply fan.

Interpreting system validation diagnostic front panel LEDs and audible codes

During the system validation phase that occurs at system startup, the BIOS validates the functionality of the following subsystems and conditions:

- AC adapter
- System board power
- Processor failure
- BIOS corruption
- Memory failure
- Graphics failure
- System board failure
- BIOS authentication failure

If an error is detected, specific patterns of long and short blinks, accompanied by long and short beeps (where applicable) are used to identify the error. These patterns will make up a two part code:

- Major – the category of the error
- Minor – the specific error within the category



NOTE: Single beep/blink codes are not used.

Number of long beeps/blinks	Error category
1	Not used
2	BIOS
3	Hardware

Number of long beeps/blinks	Error category
4	Thermal
5	System board

Patterns of blink/beep codes are determined by using the following parameters:

- 1 second pause occurs after the last major blink.
- 2 second pause occurs after the last minor blink.
- Beep error code sequences occur for the first 5 iterations of the pattern and then stop.
- Blink error code sequences continue until the computer is unplugged or the power button is pressed.



NOTE: Not all diagnostic lights and audible codes are available on all models.

The red LED blinks to represent the major error category (long blinks). The white LED blinks to represent the minor error category (short blinks). For example, '3.5' indicates 3 long red blinks and 5 short white blinks to communicate the processor is not detected.

Category	Major/minor code	Description
BIOS	2.2	The main area (DXE) of BIOS has become corrupted and there is no recovery binary image available.
	2.3	The embedded controller policy requires the user to enter a key sequence.
	2.4	The embedded controller is checking or recovering the boot block.
Hardware	3.2	The embedded controller has timed out waiting for BIOS to return from memory initialization.
	3.3	The embedded controller has timed out waiting for BIOS to return from graphics initialization.
	3.4	The system board displays a power failure (crowbar).*
	3.5	The processor is not detected.*
	3.6	The processor does not support an enabled feature.
	Thermal	4.2
4.3		An ambient temperature over temperature condition has been detected.
4.4		An MXM over temperature condition has been detected.
System board	5.2	The embedded controller cannot find valid firmware.
	5.3	The embedded controller has timed out waiting for the BIOS.
	5.4	The embedded controller has timed out waiting for BIOS to return from system board initialization.
	5.5	The embedded controller rebooted the system after a possible lockup condition had been detected through the use of a System Health Timer, Automated System Recovery Timer, or other mechanism.

* Indicates hardware triggered event; all other events are controlled by the BIOS.

8 Password security and resetting CMOS

This computer supports security password features, which can be established through the Computer Setup Utilities menu.

This computer supports two security password features that are established through the Computer Setup Utilities menu: setup password and power-on password. When you establish only a setup password, any user can access all the information on the computer except Computer Setup. When you establish only a power-on password, the power-on password is required to access Computer Setup and any other information on the computer. When you establish both passwords, only the setup password will give you access to Computer Setup.

When both passwords are set, the setup password can also be used in place of the power-on password as an override to log in to the computer. This is a useful feature for a network administrator.

If you forget the password for the computer, you can clear that password so you can gain access to the information on the computer by resetting the password jumper.

CAUTION: Pushing the CMOS button will reset CMOS values to factory defaults. It is important to back up the computer CMOS settings before resetting them in case they are needed later. Back up is easily done through Computer Setup. See [Computer Setup \(F10\) Utility on page 51](#) for information on backing up the CMOS settings.

Resetting the password jumper

CAUTION: If you enable the stringent security feature in Computer Setup and you forget the setup password or the power-on password, the computer is inaccessible and can no longer be used.

Enabling the stringent password disables the ability to reset the password by moving the jumper on the system board.

If you lose or forget the password, the system board must be replaced. This scenario is not covered under warranty.

To prevent the computer from becoming permanently unusable, record your configured setup password or power-on password in a safe place away from your computer. Without these passwords, the computer cannot be unlocked.

To disable the power-on or setup password features, or to clear the power-on or setup passwords, complete the following steps:

1. Shut down the operating system properly, then turn off the computer and any external devices, and disconnect the power cord from the power outlet.
2. With the power cord disconnected, press the power button again to drain the system of any residual power.

 **WARNING!** To reduce the risk of personal injury from electrical shock and/or hot surfaces, be sure to disconnect the power cord from the wall outlet, and allow the internal system components to cool before touching.

 **CAUTION:** When the computer is plugged in, the power supply always has voltage applied to the system board even when the unit is turned off. Failure to disconnect the power cord can result in damage to the system.

Static electricity can damage the electronic components of the computer or optional equipment. Before beginning these procedures, ensure that you are discharged of static electricity by briefly touching a grounded metal object. See the *Safety & Regulatory Information* guide for more information.

3. Remove the access panel.
4. Locate the header and jumper.

 **NOTE:** The password jumper is green so that it can be easily identified. For assistance locating the password jumper and other system board components, see the system board components image at [System board callouts – HP 285 G2 Microtower models on page 50](#).

5. Remove the jumper from pins 1 and 2.
6. Place the jumper on either pin 1 or 2, but not both, so that it does not get lost.
7. Replace the access panel and reconnect the external equipment.
8. Plug in the computer and turn on power. Allow the operating system to start. This clears the current passwords and disables the password features.
9. Shut down the computer, unplug the power, and disconnect the external equipment.
10. Remove the access panel.
11. Place the jumper on pins 1 and 2.
12. Replace the access panel.
13. Reconnect the external equipment and plug in the computer.

Changing a Setup or Power-On password

To change the power-on or setup password, complete the following steps:

1. Turn on or restart the computer.
 - To change the Setup password, go to step 2.
 - To change the Power-on password, go to step 3.
2. To change the Setup password, as soon as the computer turns on:
 - Press the Esc key while “Press the ESC key for Startup Menu” message is displayed.
 - Press the F10 key to enter Computer Setup.

3. When the key icon appears, type your current password, a slash (/) or alternate delimiter character, your new password, another slash (/) or alternate delimiter character, and your new password again as shown:

current password/new password/new password



NOTE: Type the new password carefully since the characters do not appear on the screen.

4. Press **Enter**.

The new password will take effect the next time the computer is restarted.

Deleting a Setup or Power-On password

To delete the power-on or setup password, complete the following steps:

1. Turn on or restart the computer.

To delete the Setup password, go to step 2.

To delete the Power-on password, go to step 3.

2. To delete the Setup password, as soon as the computer turns on:

- Press the Esc key while “Press the ESC key for Startup Menu” message is displayed.

- Press the F10 key to enter Computer Setup.

3. When the key icon appears, type your current password, a slash (/) or alternate delimiter character, your new password, another slash (/) or alternate delimiter character, and your new password again as shown:

current password/

4. Press **Enter**.

9 Using HP PC Hardware Diagnostics (UEFI)

HP PC Hardware Diagnostics is a Unified Extensible Firmware Interface (UEFI) that allows you to run diagnostic tests to determine whether the computer hardware is functioning properly. The tool runs outside the operating system so that it can isolate hardware failures from issues that are caused by the operating system or other software components.

When HP PC Hardware Diagnostics (UEFI) detects a failure that requires hardware replacement, a 24-digit Failure ID code is generated. This ID code can then be provided to support to help determine how to correct the problem.

 **NOTE:** To start diagnostics on a convertible computer, your computer must be in notebook mode and you must use the keyboard attached.

To start HP PC Hardware Diagnostics (UEFI), follow these steps:

1. Turn on or restart the computer, and quickly press [esc](#).
2. Press [f2](#).

The BIOS searches three places for the diagnostic tools, in the following order:

- a. Connected USB drive

 **NOTE:** To download the HP PC Hardware Diagnostics (UEFI) tool to a USB drive, see [Downloading HP PC Hardware Diagnostics \(UEFI\) to a USB device on page 99](#).

- b. Hard drive
- c. BIOS

3. When the diagnostic tool opens, select the type of diagnostic test you want to run, and then follow the on-screen instructions.

 **NOTE:** If you need to stop a diagnostic test, press [esc](#).

Downloading HP PC Hardware Diagnostics (UEFI) to a USB device

 **NOTE:** The HP PC Hardware Diagnostics (UEFI) download instructions are provided in English only, and you must use a Windows computer to download and create the HP UEFI support environment because only .exe files are offered.

There are two options to download HP PC Hardware Diagnostics to a USB device.

Download the latest UEFI version

1. Go to <http://www.hp.com/go/techcenter/pcdiags>. The HP PC Diagnostics home page is displayed.
2. In the HP PC Hardware Diagnostics section, select the **Download** link, and then select **Run**.

Download any version of UEFI for a specific product

1. Go to <http://www.hp.com/support>.
2. Select **Get software and drivers**.

3. Enter the product name or number.

– or –

Select **Identify now** to let HP automatically detect your product.

4. Select your computer, and then select your operating system.
5. In the **Diagnostic** section, follow the on-screen instructions to select and download the UEFI version you want.

10 System backup and recovery

Backing up, restoring, and recovering in Windows 10

This section provides information about the following processes. The information in the section is standard procedure for most products.

- Creating recovery media and backups
- Restoring and recovering your system

For additional information, refer to Help and Support.

- ▲ Type `help` in the taskbar search box, and then select **Help and Support**.

Creating recovery media and backups

The following methods of creating recovery media and backups are available on select products only. Choose the available method according to your computer model.

- Use HP Recovery Manager to create HP Recovery media after you successfully set up the computer. This step creates a backup of the HP Recovery partition on the computer. The backup can be used to reinstall the original operating system in cases where the hard drive is corrupted or has been replaced. For information on creating recovery media, see [Creating HP Recovery media \(select products only\) on page 101](#). For information on the recovery options that are available using the recovery media, see [What you need to know before you get started on page 103](#).
- Use Windows tools to create system restore points and create backups of personal information.

For more information, see [Using Windows tools on page 102](#).



NOTE: If storage is 32 GB or less, Microsoft System Restore is disabled by default.

Creating HP Recovery media (select products only)

If possible, check for the presence of the Recovery partition and the Windows partition. From the Start menu, select **File Explorer**.

- If your computer does not list the Windows partition and the Recovery partition, you can obtain recovery media for your system from support. See the *Worldwide Telephone Numbers* booklet included with the computer. You can also find contact information on the HP website. Go to <http://www.hp.com/support>, select your country or region, and follow the on-screen instructions.

You can use Windows tools to create system restore points and create backups of personal information, see [Using Windows tools on page 102](#).

- If your computer does list the Recovery partition and the Windows partition, you can use HP Recovery Manager to create recovery media after you successfully set up the computer. HP Recovery media can be used to perform system recovery if the hard drive becomes corrupted. System recovery reinstalls the original operating system and software programs that were installed at the factory and then configures the settings for the programs. HP Recovery media can also be used to customize the system or restore the factory image if you replace the hard drive.

- Only one set of recovery media can be created. Handle these recovery tools carefully, and keep them in a safe place.
- HP Recovery Manager examines the computer and determines the required storage capacity for the media that will be required.
- To create recovery discs, your computer must have an optical drive with DVD writer capability, and you must use only high-quality blank DVD-R, DVD+R, DVD-R DL, or DVD+R DL discs. Do not use rewritable discs such as CD±RW, DVD±RW, double-layer DVD±RW, or BD-RE (rewritable Blu-ray) discs; they are not compatible with HP Recovery Manager software. Or, instead, you can use a high-quality blank USB flash drive.
- If your computer does not include an integrated optical drive with DVD writer capability, but you would like to create DVD recovery media, you can use an external optical drive (purchased separately) to create recovery discs. If you use an external optical drive, it must be connected directly to a USB port on the computer; the drive cannot be connected to a USB port on an external device, such as a USB hub. If you cannot create DVD media yourself, you can obtain recovery discs for your computer from HP. See the *Worldwide Telephone Numbers* booklet included with the computer. You can also find contact information on the HP website. Go to <http://www.hp.com/support>, select your country or region, and follow the on-screen instructions.
- Be sure that the computer is connected to AC power before you begin creating the recovery media.
- The creation process can take an hour or more. Do not interrupt the creation process.
- If necessary, you can exit the program before you have finished creating all of the recovery DVDs. HP Recovery Manager will finish burning the current DVD. The next time you start HP Recovery Manager, you will be prompted to continue.

To create HP Recovery media:

1. Type `recovery` in the taskbar search box, and then select **HP Recovery Manager**.
2. Select **Create recovery media**, and then follow the on-screen instructions.

If you ever need to recover the system, see [Recovering using HP Recovery Manager on page 103](#).

Using Windows tools

You can create recovery media, system restore points, and backups of personal information using Windows tools.

 **NOTE:** If storage is 32 GB or less, Microsoft System Restore is disabled by default.

For more information and steps, see Help and Support.

▲ Type `help` in the taskbar search box, and then select Help and Support.

Restore and recovery

There are several options for recovering your system. Choose the method that best matches your situation and level of expertise:

 **IMPORTANT:** Not all methods are available on all products.

- Windows offers several options for restoring from backup, refreshing the computer, and resetting the computer to its original state. For more information see Help and Support.

- ▲ Type `help` in the taskbar search box, and then select **Help and Support**.
- If you need to correct a problem with a preinstalled application or driver, use the Reinstall drivers and/or applications option (select products only) of HP Recovery Manager to reinstall the individual application or driver.
 - ▲ Type `recovery` in the taskbar search box, select **HP Recovery Manager**, select **Reinstall drivers and/or applications**, and then follow the on-screen instructions.
- If you want to recover the Windows partition to original factory content, you can choose the System Recovery option from the HP Recovery partition (select products only) or use the HP Recovery media. For more information, see [Recovering using HP Recovery Manager on page 103](#). If you have not already created recovery media, see [Creating HP Recovery media \(select products only\) on page 101](#).
- On select products, if you want to recover the computer's original factory partition and content, or if you have replaced the hard drive, you can use the Factory Reset option of HP Recovery media. For more information, see [Recovering using HP Recovery Manager on page 103](#).
- On select products, if you want to remove the recovery partition to reclaim hard drive space, HP Recovery Manager offers the Remove Recovery Partition option.

For more information, see [Removing the HP Recovery partition \(select products only\) on page 104](#).

Recovering using HP Recovery Manager

HP Recovery Manager software allows you to recover the computer to its original factory state by using the HP Recovery media that you either created or that you obtained from HP, or by using the HP Recovery partition (select products only). If you have not already created recovery media, see [Creating HP Recovery media \(select products only\) on page 101](#).

What you need to know before you get started

- HP Recovery Manager recovers only software that was installed at the factory. For software not provided with this computer, you must either download the software from the manufacturer's website or reinstall the software from the media provided by the manufacturer.

 **IMPORTANT:** Recovery through HP Recovery Manager should be used as a final attempt to correct computer issues.

- HP Recovery media must be used if the computer hard drive fails. If you have not already created recovery media, see [Creating HP Recovery media \(select products only\) on page 101](#).
- To use the Factory Reset option (select products only), you must use HP Recovery media. If you have not already created recovery media, see [Creating HP Recovery media \(select products only\) on page 101](#).
- If your computer does not allow the creation of HP Recovery media or if the HP Recovery media does not work, you can obtain recovery media for your system from support. See the *Worldwide Telephone Numbers* booklet included with the computer. You can also find contact information from the HP website. Go to <http://www.hp.com/support>, select your country or region, and follow the on-screen instructions.

 **IMPORTANT:** HP Recovery Manager does not automatically provide backups of your personal data. Before beginning recovery, back up any personal data you want to retain.

Using HP Recovery media, you can choose from one of the following recovery options:

 **NOTE:** Only the options available for your computer display when you start the recovery process.

- System Recovery—Reinstalls the original operating system, and then configures the settings for the programs that were installed at the factory.
- Factory Reset—Restores the computer to its original factory state by deleting all information from the hard drive and re-creating the partitions. Then it reinstalls the operating system and the software that was installed at the factory.

The HP Recovery partition (select products only) allows System Recovery only.

Using the HP Recovery partition (select products only)

The HP Recovery partition allows you to perform a system recovery without the need for recovery discs or a recovery USB flash drive. This type of recovery can be used only if the hard drive is still working.

To start HP Recovery Manager from the HP Recovery partition:

1. Type `recovery` in the taskbar search box, select **Recovery Manager**, and then select **HP Recovery Environment**.
- or -
Press **f11** while the computer boots, or press and hold **f11** as you press the power button.
2. Select **Troubleshoot** from the boot options menu.
3. Select **Recovery Manager**, and then follow the on-screen instructions.

Using HP Recovery media to recover

You can use HP Recovery media to recover the original system. This method can be used if your system does not have an HP Recovery partition or if the hard drive is not working properly.

1. If possible, back up all personal files.
2. Insert the HP Recovery media, and then restart the computer.



NOTE: If the computer does not automatically restart in HP Recovery Manager, change the computer boot order. See [Changing the computer boot order on page 104](#).

3. Follow the on-screen instructions.

Changing the computer boot order

If your computer does not restart in HP Recovery Manager, you can change the computer boot order, which is the order of devices listed in BIOS where the computer looks for startup information. You can change the selection to an optical drive or a USB flash drive.

To change the boot order:

1. Insert the HP Recovery media.
2. Access BIOS.
Restart the computer, quickly press **esc**, and then press **f9** for boot options.
3. Select the optical drive or USB flash drive from which you want to boot.
4. Follow the on-screen instructions.

Removing the HP Recovery partition (select products only)

HP Recovery Manager software allows you to remove the HP Recovery partition to free up hard drive space.

 **IMPORTANT:** After you remove the HP Recovery partition, you will not be able to perform System Recovery or create HP recovery media from the HP Recovery partition. So before you remove the Recovery partition, create HP Recovery media; see [Creating HP Recovery media \(select products only\) on page 101](#).

 **NOTE:** The Remove Recovery Partition option is only available on products that support this function.

Follow these steps to remove the HP Recovery partition:

1. Type `recovery` in the taskbar search box, and then select **HP Recovery Manager**.
2. Select **Remove Recovery Partition**, and then follow the on-screen instructions.

Backing up, restoring, and recovering in Windows 7

Your computer includes tools provided by HP and Windows to help you safeguard your information and retrieve it if you ever need to. These tools will help you return your computer to a proper working state or even back to the original factory state, all with simple steps.

This section provides information about the following processes:

- Creating recovery media and backups
- Restoring and recovering your system

 **NOTE:** This section describes an overview of backing up, restoring, and recovering options. For more details about the Windows Backup and Restore tools provided, see Help and Support. To access Help and Support, select **Start > Help and Support**.

Recovery after a system failure is only as good as your most recent backup.

1. After you successfully set up the computer, create recovery media. This media can be used to reinstall the original operating system in cases where the hard drive is corrupted or has been replaced. See [Creating recovery media on page 105](#).
2. As you add hardware and software programs, create system restore points. A system restore point is a snapshot of certain hard drive contents saved by Windows System Restore at a specific time. A system restore point contains information that Windows uses, such as registry settings. Windows creates a system restore point for you automatically during a Windows update and during other system maintenance (such as a software update, security scanning, or system diagnostics). You can also manually create a system restore point at any time. For more information and steps for creating specific system restore points, see Help and Support. To access Help and Support, select **Start > Help and Support**.
3. As you add photos, video, music, and other personal files, create a backup of your personal information. If files are accidentally deleted from the hard drive and they can no longer be restored from the Recycle Bin, or if files become corrupted, you can restore the files that you backed up. In case of system failure, you can use the backup files to restore the contents of your computer. See [Backing up your information on page 107](#).

 **NOTE:** HP recommends that you print the recovery procedures and save them for later use, in case of system instability.

Creating recovery media

After you successfully set up the computer, create recovery media. The media can be used to reinstall the original operating system in cases where the hard drive is corrupted or has been replaced.

There are two types of recovery media. To determine which steps to follow for your computer:

1. Click the **Start** button.
2. Click **All Programs**.
 - If **Security and Protection** is listed, continue with the steps in [Creating recovery media using HP Recovery Manager \(select models only\) on page 106](#).
 - If **Productivity and Tools** is listed, continue with the steps in [Creating recovery discs with HP Recovery Disc Creator \(select models only\) on page 107](#).

Creating recovery media using HP Recovery Manager (select models only)

- To create recovery discs, your computer must have a DVD writer. Use DVD+R or DVD-R discs (purchased separately). The discs you use will depend on the type of optical drive you are using.

 **NOTE:** DVD+R DL, DVD-R DL, or DVD±RW disc are not supported.

- You have the option of creating a recovery USB flash drive instead, using a high-quality USB drive.
- If you are creating recovery discs, be sure to use high-quality discs. It is normal for the system to reject defective discs. You will be prompted to insert a new blank disc to try again.
- The number of discs in the recovery-disc set depends on your computer model (typically 3 to 6 DVDs). The Recovery Media Creation program tells you the specific number of blank discs needed to make the set. If you are using a USB flash drive, the program will tell you the size of the drive required to store all the data (minimum of 8 GB).

 **NOTE:** The process of creating recovery media is lengthy. You can quit the process at any time. The next time you initiate the process, it resumes where it left off.

 **NOTE:** Do not use media cards for creating recovery media. The system may not be able to boot up from a media card and you may not be able to run system recovery.

To create recovery discs:

1. Close all open programs.
2. Click the **Start** button, click **All Programs**, click **Security and Protection**, click **Recovery Manager**, and then click **HP Recovery Media Creation**. If prompted, click **Yes** to allow the program to continue.
3. Click **Create recovery media using blank DVD(s)**, and then click **Next**.
4. Follow the on-screen instructions. Label each disc after you make it (for example, Recovery 1, Recovery 2), and then store the discs in a secure place.

To create a recovery USB flash drive:

 **NOTE:** You must use a USB flash drive with a capacity of at least 8 GB.

 **NOTE:** Recovery Media Creation formats the USB flash drive, deleting any files on it.

1. Close all open programs.
2. Insert the USB flash drive into a USB port on the computer.
3. Click the **Start** button, click **All Programs**, click **Security and Protection**, click **Recovery Manager**, and then click **Recovery Media Creation**.
4. Click **Create recovery media with a USB flash drive**, and then click **Next**.

5. Select the USB flash drive from the list of media. The program will let you know how much storage is required to create the recovery drive. If the USB flash drive does not have enough storage capacity, it will appear grayed out, and you must replace it with a larger USB flash drive. Click **Next**.
6. Follow the on-screen instructions. When the process is complete, label the USB flash drive and store it in a secure place.

Creating recovery discs with HP Recovery Disc Creator (select models only)

HP Recovery Disc Creator is a software program that offers an alternative way to create recovery discs on select models. After you successfully set up the computer, you can create recovery discs using HP Recovery Disc Creator. The recovery discs allow you to reinstall your original operating system as well as select drivers and applications if the hard drive becomes corrupted. HP Recovery Disc Creator creates two kinds of recovery discs:

- Windows 7 operating system DVD—Installs the operating system without additional drivers or applications.
- *Driver Recovery* DVD—Installs specific drivers and applications only, in the same way that the HP Software Setup utility installs drivers and applications.

To create recovery discs, your computer must have a DVD writer. Use any of the following types of discs (purchased separately): DVD+R, DVD+R DL, DVD-R, DVD-R DL, or DVD±RW. The discs you use will depend on the type of optical drive you are using.

Creating recovery discs

 **NOTE:** The Windows 7 operating system DVD can be created only once. The option to create that media will not be available after you create a Windows DVD.

To create the Windows DVD:

1. Select **Start > All Programs > Productivity and Tools > HP Recovery Disc Creator**.
2. Select **Windows disk**.
3. From the drop-down menu, select the drive for burning the recovery media.
4. Click the **Create** button to start the burning process. Label the disc after you create it, and store it in a secure place.

After the Windows 7 operating system DVD has been created, create the *Driver Recovery* DVD:

1. Select **Start > All Programs > Productivity and Tools > HP Recovery Disc Creator**.
2. Select **Driver disk**.
3. From the drop-down menu, select the drive for burning the recovery media.
4. Click the **Create** button to start the burning process. Label the disc after you create it, and store it in a secure place.

Backing up your information

You should create your initial backup immediately after initial system setup. As you add new software and data files, you should continue to back up your system on a regular basis to maintain a reasonably current backup. Your initial and subsequent backups allow you to restore your data and settings if a failure occurs.

You can back up your information to an optional external hard drive, a network drive, or discs.

Note the following when backing up:

- Store personal files in the Documents library, and back it up regularly.
- Back up templates that are stored in their associated directories.
- Save customized settings that appear in a window, toolbar, or menu bar by taking a screen shot of your settings. The screen shot can be a time-saver if you have to reset your preferences.
- When backing up to discs, number each disc after removing it from the drive.

 **NOTE:** For detailed instructions on various backup and restore options, perform a search for these topics in Help and Support. To access Help and Support, select **Start > Help and Support**.

 **NOTE:** You may be prompted by User Account Control for your permission or password when you perform certain tasks. To continue a task, select the appropriate option. For information about User Account Control, see Help and Support: Select **Start > Help and Support**.

To create a backup using Windows Backup and Restore:

 **NOTE:** The backup process may take over an hour, depending on file size and the speed of the computer.

1. Select **Start > All Programs > Maintenance > Backup and Restore**.
2. Follow the on-screen instructions to set up your backup.

System Restore

If you have a problem that might be due to software that you installed on your computer, or if you want to restore the system to a previous state without losing any personal information, use System Restore to return the computer to a previous restore point.

 **NOTE:** Always use this System Restore procedure before you use the System Recovery feature.

To start System Restore:

1. Close all open programs.
2. Click the **Start** button, right-click **Computer**, and then click **Properties**.
3. Click **System protection, System Restore**, click **Next**, and then follow the on-screen instructions.

System Recovery

 **WARNING!** This procedure will delete all user information. To prevent loss of information, be sure to back up all user information so you can restore it after recovery.

System Recovery completely erases and reformats the hard disk drive, deleting all data files that you have created, and then reinstalls the operating system, programs, and drivers. However, you must reinstall any software that was not installed on the computer at the factory. This includes software that came on media included in the computer accessory box, and any software programs you installed after purchase. Any personal files must be restored from backups you made.

If you were not able to create system recovery DVDs or USB flash drive, you can order a recovery disc set from support. Go to <http://www.hp.com/support>, select your country or region, and follow the on-screen instructions.

 **NOTE:** Always use the System Restore procedure before you use the System Recovery program. See [System Restore on page 108](#).

You must choose one of the following methods to perform a System Recovery:

- Recovery image — Run System Recovery from a recovery image stored on your hard disk drive. The recovery image is a file that contains a copy of the original factory-shipped software. To perform a System Recovery from a recovery image, see [System Recovery when Windows is responding on page 109](#) or [System Recovery when Windows is not responding on page 109](#).
- Recovery media — Run System Recovery from recovery media that you have created from files stored on your hard disk drive or purchased separately. See [System Recovery using recovery media \(select models only\) on page 110](#).

System Recovery when Windows is responding

 **CAUTION:** System Recovery deletes all data and programs you created or installed. Before you begin, back up any important data to a CD or DVD or to a USB flash drive.

 **NOTE:** In some cases, you must use recovery media for this procedure. If you have not already created this media, follow the instructions in [Creating recovery media on page 105](#).

If the computer is working and Windows 7 is responding, use these steps to perform a System Recovery:

1. Turn off the computer.
2. Disconnect all peripheral devices from the computer except the monitor, keyboard, and mouse.
3. Turn on the computer.
4. When Windows has loaded, click the **Start** button, and then click **All Programs**.
 - If **Security and Protection** is listed, continue with step [5](#).
 - If **Productivity and Tools** is listed, follow the steps in [System Recovery when Windows is not responding on page 109](#).
5. Click **Security and Protection**, click **Recovery Manager**, and then click **Recovery Manager**. If prompted, click **Yes** to allow the program to continue.
6. Under **I need help immediately**, click **System Recovery**.
7. Select **Yes**, and then click **Next**. Your computer restarts.
8. When the computer restarts, you will see the Recovery Manager welcome screen again. Under **I need help immediately**, click **System Recovery**. If you are prompted to back up your files, and you have not done so, select **Back up your files first (recommended)**, and then click **Next**. Otherwise, select **Recover without backing up your files**, and then click **Next**.
9. System Recovery begins. After System Recovery is complete, click **Finish** to restart the computer.
10. When Windows has loaded, shut down the computer, reconnect all peripheral devices, and then turn the computer back on.

System Recovery when Windows is not responding

 **CAUTION:** System Recovery deletes all data and programs you created or installed.

If Windows is not responding, but the computer is working, follow these steps to perform a System Recovery.

1. Turn off the computer. If necessary, press and hold the power button until the computer turns off.
2. Disconnect all peripheral devices from the computer, except the monitor, keyboard, and mouse.
3. Press the power button to turn on the computer.
4. As soon as you see the HP logo screen, repeatedly press the **F11** key on your keyboard until the *Windows is Loading Files...* message appears on the screen.

5. At the HP Recovery Manager screen, follow the on-screen instructions to continue.
6. When Windows has loaded, shut down the computer, reconnect all peripheral devices, and then turn the computer back on.

System Recovery using recovery media (select models only)

Use the steps provided in this section if you created recovery media using [Creating recovery media using HP Recovery Manager \(select models only\) on page 106](#). If you used HP Recovery Disc Creator to create a Windows 7 operating system DVD and a *Driver Recovery* DVD, use the steps in [Using HP Recovery Disc operating system discs \(select models only\) on page 110](#).

⚠ CAUTION: System Recovery deletes all data and programs you have created or installed. Back up any important data to a CD or DVD or to a USB flash drive.

To perform a System Recovery using recovery media:

1. If you are using a set of DVDs, insert the first recovery disc into the DVD drive tray, and close the tray. If you are using a recovery USB flash drive, insert it into a USB port.
2. Click the **Start** button, and then click **Shut Down**.

or
If the computer is not responding, press and hold the power button for approximately 5 seconds or until the computer turns off.
3. Disconnect all peripheral devices from the computer except the monitor, keyboard, and mouse.
4. Press the power button to turn on the computer, and press **Esc** as the computer is powering on to display the startup menu.
5. Use the arrow keys to select the boot menu, and press **Enter**. Use the arrow keys to select the location where the recovery media is inserted (USB or DVD). Press **Enter** to boot from that device.
6. If Recovery Manager asks if you want to run System Recovery from Media or Hard Drive, select **Media**. On the Welcome screen, under **I need help immediately**, click **Factory Reset**.
7. If you are prompted to back up your files, and you have not done so, select **Back up your files first (recommended)**, and then click **Next**. Otherwise, select **Recover without backing up your files**, and then click **Next**.
8. If you are prompted to insert the next recovery disc, do so.
9. When Recovery Manager is finished, remove the recovery disc or the recovery USB flash drive from the system.
10. Click **Finish** to restart the computer.

Using HP Recovery Disc operating system discs (select models only)

Use the steps provided in this section if you used HP Recovery Disc Creator to create a Windows 7 operating system DVD and a *Driver Recovery* DVD. If you created recovery media using [Creating recovery media using HP Recovery Manager \(select models only\) on page 106](#), use the steps in [System Recovery using recovery media \(select models only\) on page 110](#).

If you cannot use the recovery discs you previously created using the HP Recovery Disc Creator (select models only), you must purchase a Windows 7 operating system DVD to reboot the computer and repair the operating system.

To order a Windows 7 operating system DVD, contact support. Go to <http://www.hp.com/support>, select your country or region, and follow the on-screen instructions.

 **CAUTION:** Using a Windows 7 operating system DVD completely erases the hard drive contents and reformats the hard drive. All files that you have created and any software that you have installed on the computer are permanently removed. When reformatting is complete, the recovery process helps you restore the operating system, as well as drivers, software, and utilities.

To initiate recovery using a Windows 7 operating system DVD:

 **NOTE:** This process takes several minutes.

1. If possible, back up all personal files.
2. Restart the computer, and then insert the Windows 7 operating system DVD into the optical drive before the Windows operating system loads.

 **NOTE:** If the computer does not boot to the DVD, restart the computer and press **Esc** as the computer is powering on to see the startup menu. Use the arrow keys to select the boot menu and press **Enter**. Use the arrow keys to select the location where the recovery DVD is inserted. Press **Enter** to boot from that device.

3. When prompted, press any keyboard key.
4. Follow the on-screen instructions.
5. Click **Next**.
6. Select **Install now**.
7. Follow the on-screen instructions.

After the repair is completed:

1. Eject the Windows 7 operating system DVD and then insert the *Driver Recovery* DVD.
2. Follow the on-screen instructions to install the Hardware Enabling Drivers first, and then install Recommended Applications.

A Battery replacement

The battery installed on the computer provides power to the real-time clock. When replacing the battery, use a battery equivalent to the battery originally installed on the computer. The computer has a 3-volt lithium coin cell battery installed.

 **WARNING!** The computer contains an internal lithium manganese dioxide battery. There is a risk of fire and burns if the battery is not handled properly. To reduce the risk of personal injury:

Do not attempt to recharge the battery.

Do not expose to temperatures higher than 60°C (140°F).

Do not disassemble, crush, puncture, short external contacts, or dispose of in fire or water.

Replace the battery only with the HP spare designated for this product.

 **CAUTION:** Before replacing the battery, it is important to back up the computer CMOS settings. When the battery is removed or replaced, the CMOS settings will be cleared.

Static electricity can damage the electronic components of the computer or optional equipment. Before beginning these procedures, ensure that you are discharged of static electricity by briefly touching a grounded metal object.

 **NOTE:** The lifetime of the lithium battery can be extended by plugging the computer into a live AC wall socket. The lithium battery is only used when the computer is NOT connected to AC power.

HP encourages customers to recycle used electronic hardware, HP original print cartridges, and rechargeable batteries. For more information about recycling programs, go to <http://www.hp.com/recycle>.

-
1. Remove/disengage any security devices that prohibit opening the computer.
 2. Remove all removable media, such as compact discs or USB flash drives, from the computer.
 3. Turn off the computer properly through the operating system, then turn off any external devices.
 4. Disconnect the power cord from the power outlet and disconnect any external devices.

 **CAUTION:** Regardless of the power-on state, voltage is always present on the system board as long as the system is plugged into an active AC outlet. You must disconnect the power cord to avoid damage to the internal components of the computer.

-
5. Remove the computer access panel.
 6. Locate the battery and battery holder on the system board.

 **NOTE:** On some computer models, it may be necessary to remove an internal component to gain access to the battery.

-
7. Depending on the type of battery holder on the system board, complete the following instructions to replace the battery.

Type 1

- a. Lift the battery out of its holder.

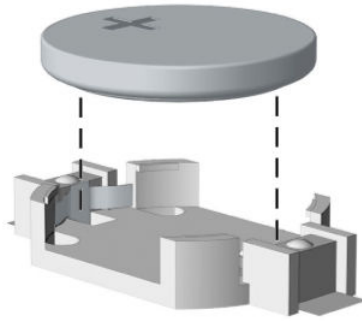

- b.** Slide the replacement battery into position, positive side up. The battery holder automatically secures the battery in the proper position.

Type 2

- a.** To release the battery from its holder, squeeze the metal clamp that extends above one edge of the battery. When the battery pops up, lift it out (1).
- b.** To insert the new battery, slide one edge of the replacement battery under the lip of the holder with the positive side up. Push the other edge down until the clamp snaps over the other edge of the battery (2).

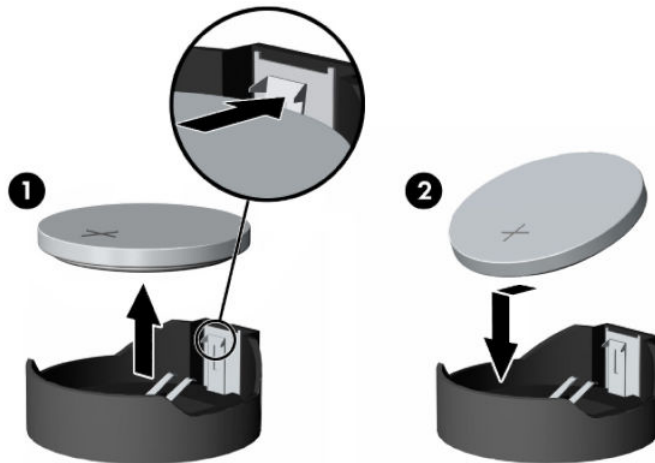

Type 3

- a.** Pull back on the clip (1) that is holding the battery in place, and remove the battery (2).

- b. Insert the new battery and position the clip back into place.

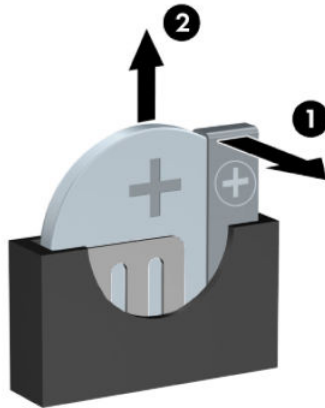

 **NOTE:** After the battery has been replaced, use the following steps to complete this procedure.

8. Replace the computer access panel.
9. Plug in the computer and turn on power to the computer.
10. Reset the date and time, your passwords, and any special system setups using Computer Setup.
11. Lock any security devices that were disengaged when the computer access panel was removed.

B Power Cord Set Requirements

The power supplies on some computers have external power switches. The voltage select switch feature on the computer permits it to operate from any line voltage between 100-120 or 220-240 volts AC. Power supplies on those computers that do not have external power switches are equipped with internal switches that sense the incoming voltage and automatically switch to the proper voltage.

The power cord set received with the computer meets the requirements for use in the country where you purchased the equipment.

Power cord sets for use in other countries must meet the requirements of the country where you use the computer.

General Requirements

The requirements listed below are applicable to all countries:

1. The power cord must be approved by an acceptable accredited agency responsible for evaluation in the country where the power cord set will be installed.
2. The power cord set must have a minimum current capacity of 10A (7A Japan only) and a nominal voltage rating of 125 or 250 volts AC, as required by each country's power system.
3. The diameter of the wire must be a minimum of 0.75 mm² or 18AWG, and the length of the cord must be between 1.8 m (6 feet) and 3.6 m (12 feet).

The power cord should be routed so that it is not likely to be walked on or pinched by items placed upon it or against it. Particular attention should be paid to the plug, electrical outlet, and the point where the cord exits from the product.

 **WARNING!** Do not operate this product with a damaged power cord set. If the power cord set is damaged in any manner, replace it immediately.

Japanese Power Cord Requirements

For use in Japan, use only the power cord received with this product.

 **CAUTION:** Do not use the power cord received with this product on any other products.

Country-Specific Requirements

Additional requirements specific to a country are shown in parentheses and explained below.

Country	Accrediting Agency	Country	Accrediting Agency
Australia (1)	EANSW	Italy (1)	IMQ
Austria (1)	OVE	Japan (3)	METI
Belgium (1)	CEBC	Norway (1)	NEMKO
Canada (2)	CSA	Sweden (1)	SEMKO
Denmark (1)	DEMKO	Switzerland (1)	SEV
Finland (1)	SETI	United Kingdom (1)	BSI
France (1)	UTE	United States (2)	UL
Germany (1)	VDE		

1. The flexible cord must be Type H05VV-F, 3-conductor, 0.75mm² conductor size. Power cord set fittings (appliance coupler and wall plug) must bear the certification mark of the agency responsible for evaluation in the country where it will be used.
2. The flexible cord must be Type SVT or equivalent, No. 18 AWG, 3-conductor. The wall plug must be a two-pole grounding type with a NEMA 5-15P (15A, 125V) or NEMA 6-15P (15A, 250V) configuration.
3. Appliance coupler, flexible cord, and wall plug must bear a “T” mark and registration number in accordance with the Japanese Dentori Law. Flexible cord must be Type VCT or VCTF, 3-conductor, 0.75 mm² conductor size. Wall plug must be a two-pole grounding type with a Japanese Industrial Standard C8303 (7A, 125V) configuration.

C Statement of Volatility

HP confirms that business desktop systems contain DDR3 or DDR4 volatile memory (memory amount depends on the customer configuration). In addition, the motherboard in the condition originally shipped without subsequent modification or the addition or installation of any applications, features, or functionality, contain the following nonvolatile memory: Real Time Clock battery backed-up configuration memory (256 Bytes), DIMM Serial Presence Detect (SPD) configuration data (256 Bytes per module, 128 Bytes programmable), Serial Peripheral Interface (SPI) ROM for System BIOS (8M Bytes) and Super I/O's: masked keyboard ROM (overall 2K Bytes). In addition, these units contain a Trusted Platform Module (TPM) that contains 16K Bytes of non-volatile memory for user data. The volatile memory will not hold any user data once power has been removed for 30 seconds or longer.

The following procedure shows the steps that should be taken to restore the Non-Volatile memory:

1. Download the latest BIOS (system ROM) from the HP website.
2. Follow the instructions to flash the BIOS that are found on the website.
Flashing the BIOS will reset it back to factory settings.
3. Turn on the system, and while system is powering on, and after the HP splash screen, press the **F10** key to enter BIOS setup screen.
4. Select **Security > System Security** from the main menu. If the Embedded Security Device Support option is set to "Disable", skip to step 7.
5. To erase all security keys from the TPM:
Under **Embedded Security Device** in the **System Security** menu, configure **Reset to Factory Settings to Reset**.



NOTE: Although the TPM security keys will be cleared, data in the non-volatile memory indices may not be. Data stored in these indices should not contain security sensitive information. If an application locks down and secures the non-volatile indices, these indices cannot be cleared.

6. Press **F10** to accept changes.
7. To clear the secure boot key database:
 - a. Enter the F10 setup utility.
 - b. Go to the **Security** menu.
 - c. Select **Secure Boot Configuration**.
 - d. In the **Key Management** section, select **clear Secure boot keys**.
 - e. Use space key to select **clear**.
 - f. Press the **F10** key to accept changes.
 - g. From the main menu select **File > Save Changes and Exit**.
8. If the Ownership Tag or Asset Tag is set, manually clear it under **Security > System Ids**.
9. Select **File > Save Changes and Exit**.
10. To clear the Setup or Power-On passwords if set, and clear any other settings, power down the computer and remove the AC power cord and the computer hood.

11. Locate the two pin password jumper labeled CLR_PSWD and remove it.
12. Remove the AC power, wait 10 seconds until the unit AC power has drained out.
13. Replace the hood and AC power cord and turn the computer on. The passwords are now cleared and all other user-configurable, non-volatile memory settings are reset to their factory default values.
14. Enter the F10 setup utility.
15. Select **File > Default Setup > Restore Factory Settings as Default**. This will set the default settings back to the factory defaults.
16. Select **File > Apply Defaults and Exit**.
17. Shut down the computer, remove the AC power cord and place the (blue/green) jumper back on header E49. Replace the computer hood and power cord.

If Computrace is enabled on the computer, see the service provider for instruction to disable the feature.

D Specifications

MT Specifications

Table D-1 Specifications

Chassis		
Height	14.13 in	35.88 cm
Width	6.69 in	17.00 cm
Depth	13.98 in	35.50 cm
Approximate Weight	13.47 lb	6.11 kg
Temperature Range		
Operating	50° to 95°F	10° to 35°C
Nonoperating	-22° to 140°F	-30° to 60°C
NOTE: Operating temperature is derated 1.0° C per 300 m (1000 ft) to 3000 m (10,000 ft) above sea level; no direct sustained sunlight. Maximum rate of change is 10° C/Hr. The upper limit may be limited by the type and number of options installed.		
Relative Humidity (noncondensing)		
Operating	10-90%	10-90%
Nonoperating (38.7°C max wet bulb)	5-95%	5-95%
Maximum Altitude (unpressurized)		
Operating	10,000 ft	3048 m
Nonoperating	30,000 ft	9144 m
Power Supply		
Operating Voltage Range	90-264 VAC	
Rated Voltage Range ¹	100-240 VAC	
Rated Line Frequency	50-60 Hz	
Operating Line Frequency	47-63 Hz	
Output		
	180W active PFC	
	300W active PFC	

¹ This system utilizes an active power factor corrected power supply. This allows the system to pass the CE mark requirements for use in the countries of the European Union. The active power factor corrected power supply also has the added benefit of not requiring an input voltage range select switch.

Index

- A**
 - access panel
 - illustrated 4
 - locked 62
 - removal 18
 - audible codes 94
 - audio problems 73
- B**
 - backup and recovery, Windows 7 105
 - Backup and Restore, Windows 7 108
 - backups
 - creating Windows 7 105, 107
 - battery
 - disposal 14
 - battery replacement 112
 - beep codes 94
 - booting options
 - Full Boot 89
 - Quick Boot 89
- C**
 - cable management 16
 - cable pinouts, SATA data 15
 - cautions
 - AC power 9
 - cables 14
 - cooling fan 13
 - electrostatic discharge 9
 - keyboard cleaning 12
 - keyboard keys 13
 - CD-ROM or DVD problems 83
 - changing a Power-On password 97
 - changing a Setup password 97
 - clamp lock
 - illustrated 7
 - cleaning
 - computer 12
 - mouse 13
 - safety precautions 12
 - CMOS
 - backing up 96
 - computer cleaning 12
 - Computer Setup
 - access problem 61
 - country power cord set requirements 116
 - Customer Support 59
- D**
 - deleting a Power-On password 98
 - deleting a Setup password 98
 - DIMM
 - specifications 22
 - DIMMs. *See* memory
 - disassembly preparation 17
 - Driver Recovery DVD,
 - creating 107
 - using for restore 110
 - drives
 - cable connections 28
 - installation 28
 - locations 29
 - drives spare parts 8
- E**
 - electrostatic discharge (ESD) 9
 - preventing damage 10
 - error
 - codes 89, 94
 - messages 89
 - expansion card
 - installation 25
 - removal 25
- F**
 - F10 Setup
 - access problem 61
 - fan
 - illustrated 7
 - fan sink
 - illustrated 5
 - fan, power supply 13
 - flash drive problems 85
 - flashing LEDs 94
 - front bezel
 - blank removal 21
 - illustrated 4
 - MT removal 19
 - security 20
 - front I/O assembly
 - illustrated 7
 - front panel components 2
 - front panel problems 86
 - front USB panel
 - removal and replacement 37
- G**
 - general problems 61
 - grounding methods 10
- H**
 - hard drive
 - installation 34
 - proper handling 14
 - removal 33
 - SATA characteristics 15
 - hard drive conversion bracket
 - illustrated 7
 - hard drive problems 66
 - hard drive recovery
 - Windows 7 108
 - hard drives
 - sizes 8, 28
 - hardware installation problems 78
 - heat sink
 - removal and replacement 44
 - Help and Support
 - Windows 7 105
 - helpful hints 60
 - HP PC Hardware Diagnostics (UEFI)
 - using 99
 - HP Recovery Disc Creator, using 107
- I**
 - installing
 - battery 112
 - drive cables 28
 - expansion card 25
 - hard drive 34
 - memory 22
 - optical drive 31
 - Internet access problems 87

K

keyboard
 cleaning 12
keyboard problems 76

L

locks
 front bezel 20

M

major component spare parts 4
media card reader
 problems 68
memory
 DIMMs specifications 22
 installation 22
 maximum 22
 problems 82
 slots 22
 socket population 22
 specifications 22
memory modules
 illustrated 5, 22
miscellaneous boards 8
miscellaneous spare parts 6
monitor problems 69
mouse
 cleaning 13
 problems 76
MT
 heat sink removal and
 replacement 44

N

network problems 79
numeric error codes 89

O

operating guidelines 11
optical drive
 installation 31
 options 8, 28
 problems 83
 removal 30
overheating, prevention 11

P

password
 clearing 96
 power-on 96
 setup 96

passwords 97, 98
POST error messages 89
power adapter for optical drive
 illustrated 7
power cord set requirements
 country specific 116
power problems 65
power supply
 fan 13
 illustrated 4
 operating voltage range 119
 removal and replacement 41
Power-On password 97, 98
power-on password 96
printer port
 illustrated 7
printer problems 75
problems
 audio 73
 CD-ROM or DVD 83
 Computer Setup 61
 F10 Setup 61
 flash drive 85
 front panel 86
 general 61
 hard drive 66
 hardware installation 78
 Internet access 87
 keyboard 76
 Media Card Reader 68
 memory 82
 monitor 69
 mouse 76
 network 79
 power 65
 printer 75
 software 88
processor
 removal and replacement 45, 46
product ID location 3

R

rear chassis fan
 removal and replacement 40
rear panel components 3
recovery discs, steps for creating
 Windows 7 106
recovery discs, using for restore
 110
recovery media, creating 107

recovery media, creating Windows
 7 105
recovery USB flash drive, steps for
 creating Windows 7 106
removal and replacement
 front USB panel 37
 heat sink 44
 power supply 41
 processor 45, 46
 rear chassis fan 40
 speaker 39
 system board 47
removing
 access panel 18
 battery 112
 bezel blank 21
 expansion card 25
 front bezel 19
 hard drive 33
 optical drive 30
resetting
 CMOS 96
 password jumper 96
S
safety and comfort 59
safety precautions
 cleaning 12
SATA
 connectors on system board 15
 data cable pinouts 15
 hard drive characteristics 15
SATA data cable
 illustrated 7
screws, correct size 14
Secure Digital (SD) card reader
 illustrated 7
security
 front bezel 20
serial number location 3
serial port with cable
 illustrated 7
service considerations 13
Setup password 97, 98
setup password 96
software
 problems 88
 servicing computer 13
solid-state drives
 sizes 8, 28

- speaker
 - illustrated 7
 - removal and replacement 39
- specifications
 - computer 119
- specifications, memory 22
- static electricity 9
- system board
 - illustrated 5
 - removal and replacement 47
 - SATA connectors 15
- System Recovery using Windows 7
 - recovery media 110
- System Recovery, Windows 7 108
- system restore points, creating
 - Windows 7 105
- System Restore, Windows 7 108

T

- tamper-proof screws
 - tool 13
- temperature control 11
- tools, servicing 13
- Torx T15 screwdriver 13

V

- ventilation, proper 11

W

- Windows 10
 - backup and restore 101
- Windows 7
 - backing up information 107
 - backup and recovery 105
 - Backup and Restore 108
 - creating backups 105
 - creating recovery media 105
 - creating system restore points 105
 - hard drive recovery 108
 - Help and Support 105
 - steps for creating recovery discs 106
 - steps for creating recovery media 106
 - steps for creating recovery USB flash drive 106
 - System Recovery 108
 - System Recovery using recovery media 110
 - System Restore 108

- Windows 7 operating system discs
 - using for restore 110
- Windows 7 operating system DVD
 - creating 107
 - using for restore 110
- Windows 7 operating system media
 - creating 107